

INDUSTRY
KITCHENS

www.industrykitchens.com.au 1800 611 058



The Volano B3 Vintage-Style Flywheel Slicer is craftsman-built to the highest standard using high quality modern materials and fitted with safety features.



Model
Volano BKL-B3
Flywheel Slicer



Hand Powered

Model BKL-B3 Flywheel Slicer

CE Approved

The Volano B3 Flywheel Slicer is an unpowered hand operated precision slicer.

- Quality unpowered flywheel slicer with 300mm blade
- Stunning Vintage flower design flywheel
- Constructed from aluminium and stainless steel with a high gloss red or black finish
- Fully incorporated sharpening device
- Slice thickness: 0-1.5mm
- Blade ring guard
- Optional extra: High gloss enamel vintage style stand.

B2

Dimensions

W x D x H (mm):	670 x 805 x 700
Pedestal Stand (mm):	580 x 780
Slice Thickness (mm):	0 - 1.5
Blade (mm):	300
Product Cutting Capacity:	
Rectangle (mm):	270 x 210
Round (mm):	210
Slicer Weight (kg):	46
Stand Weight (kg):	45

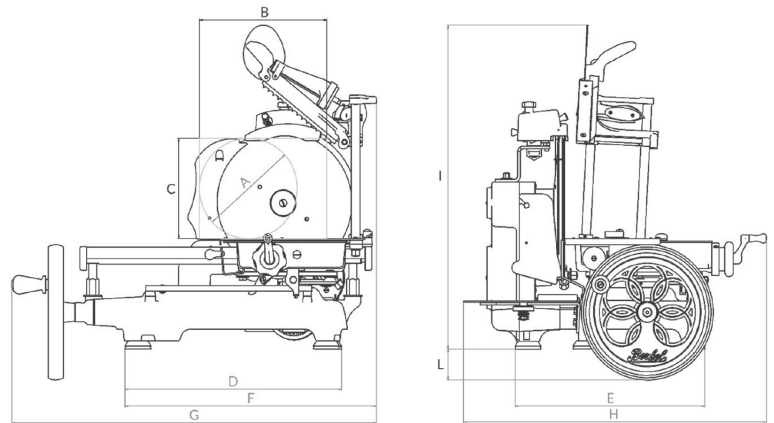

Brice Australia Pty. Ltd. ABN 71 413 589 669
100% Australian owned and operated
Copyright ©2023 Brice Australia Pty. Ltd.

BRICE HEAD OFFICE:
11 Holloway Drive, Bayswater,
Victoria 3153 Australia

Ph: 1300 664 880
www.briceaust.com.au
email: info@briceaust.com.au

