



Enhance Your
Comfort *Outdoors*

Tungsten Smart-Heat™ Collections Guide

Contents

Design & Integration.....	6
Selecting Your Fuel Source.....	7
Tungsten Smart-Heat Electric.....	8
Tungsten Smart-Heat Gas.....	14
Tungsten Smart-Heat Portable.....	20
Controls.....	25
Performance.....	26
Sustainability.....	27
Collection Lineup.....	28

Bromic is globally recognized as the leader in outdoor heating.





Tungsten Electric Heater

6000W Series Heater
Ceiling Mounted

Durability Meets *Power*

Immense Power. Bold Design.

The award-winning Tungsten Smart-Heat collection combines high-performance stainless-steel construction with strong, directional radiant heating. Available in both gas and electric fuel sources with complete versatility in mounting options including portable, wall, ceiling, and recessed, the Tungsten collection offers efficient radiant heating in a durable, industrial design style.

Looking for an outdoor heater that will get the job done in any environment? You've found it.





Tungsten Gas

300 Series (25 MJ)

Wall Mounted

Design + Integration

The Tungsten collection is manufactured with a high-temperature coating and durable stainless-steel construction to ensure longevity of use. Its unique honeycomb mesh surface and interior quartz elements project powerful directional heat keeping you and your guests warm all year round.



Tungsten Electric

With four models ranging from 2000W to 6000W, each Tungsten Electric heater provides an even flow of warmth to outdoor spaces of up to 13m². Available in both black and white with a variety of mounting options including wall, ceiling, and recessed, this high-powered heater is suitable for all environments.

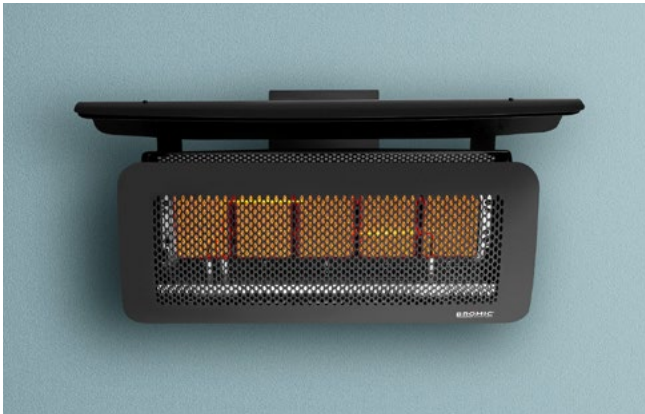

Tungsten Gas

Available in 25 MJ and 42 MJ heating power in either natural gas or propane (LPG) fuel sources, this powerful radiant heater can quickly heat outdoor areas of up to 20m². Whether mounted from the wall or ceiling, its easy pivot arm allows for greater positioning and directional heat control.



Tungsten Portable

Ideal for areas without a structure, the award-winning Tungsten Portable's modular construction and built-in wheels allow for easy maneuverability and the anti-tilt shutoff keeps safety top of mind. Available in either natural gas or propane (LPG) fuel sources, the adjustable heat controls offer ease of operation for precise levels of comfort.

Selecting Your Fuel Source

As the only manufacturer that offers outdoor heating solutions in natural gas, propane, and electric fuel sources, the fuel selection criteria can offer important advantages in your specific application. Here are three areas to consider in your design plan.

1

Climate

The physical location and placement of your heaters can leverage significant efficiency based on the fuel type.

TUNGSTEN ELECTRIC

- Ideal for enclosed and semi-enclosed applications.
- Can be dimmed for precise comfort.

TUNGSTEN GAS

- Ideal for colder environments with high ceilings and big power requirements.
- Requires ventilation.
- Is not dimmable.

TUNGSTEN PORTABLE

- Ideal for outdoor spaces without a structure.
- Requires ventilation.
- LPG fuel source is dimmable. Natural gas is not.

2

Clearances

How you integrate your heaters into your space is largely dictated by the clearances each fuel source requires. No matter the fuel source, a minimum mounting height of 2438mm is required in clearance from the floor to the bottom surface of the heating solution.

TUNGSTEN ELECTRIC

- Requires a ceiling clearance of 120mm for 2000W & 3000W and 300mm for 4000W & 6000W.

TUNGSTEN GAS

- Requires 350mm of ceiling clearance with optional heat reflector & 1100mm of vertical clearance without reflector.

TUNGSTEN PORTABLE

- Requires 1000mm of ceiling clearance as well as a 1000mm clearance from each side.

3

Cost

Operational fuel costs can have a significant impact on high use applications like Restaurants and Hospitality. Fuel costs can vary by locale.

TUNGSTEN ELECTRIC

- ±\$1.84 per hour to heat a 37m² patio.

TUNGSTEN GAS

- LPG: ±\$2.07 per hour to heat a 37m² patio.
- Natural Gas: ±\$1.06 per hour to heat a 37m² patio.

TUNGSTEN PORTABLE

- LPG: ±\$2.07 per hour to heat a 37m² patio.
- Natural Gas: ±\$1.06 per hour to heat a 37m² patio.

Tungsten Smart-Heat Electric

Available in black and white, our Tungsten Smart-Heat Electric series combines stylish, industrial design with market-leading radiant heat to outdoor spaces of up to 13m². Manufactured with a high-temperature coating, stainless-steel construction and unique honeycomb mesh surface, precise heat is distributed projecting a powerful output with a warm, soothing red glow. Complete with a variety of mounting options including wall and ceiling via two brackets that come furnished with the heater, or recessed using an available ceiling recessing kit, this heater is suitable for all environments.



Specifications

Reference the specification guide below to help you select the correct solution for your needs.

MODEL NUMBER	2000 SERIES	3000 SERIES	4000 SERIES	6000 SERIES
PRODUCT CODE	2620262	2620263	2620264	2620265
FUEL TYPE	ELECTRIC	ELECTRIC	ELECTRIC	ELECTRIC
COLOR	BLACK	BLACK	BLACK WHITE	BLACK WHITE
HEAT AREA	6M ²	9M ²	11M ²	13M ²
RATED CURRENT	230 - 240V / 8.3A	230 - 240V / 12.5A	230 - 240V / 16.6A	230 - 240V / 25A
MINIMUM FLOOR CLEARANCE	WALL 1800MM CEILING 2400MM	WALL 1800MM CEILING 2400MM	WALL 1800MM CEILING 2400MM	WALL 1800MM CEILING 2400MM
MOUNTING OPTIONS				
CEILING MOUNT	✓	✓	✓	✓
CEILING RECESS KIT PRODUCT CODES	2620226	2620227	2620226	2620227
WALL MOUNT	✓	✓	✓	✓
RECESSED FLUSH MOUNT	✓	✓	✓	✓
CEILING POLE MOUNT	✓	✓	✓	✓
TUBE SUSPENSION KIT (900MM) PRODUCT CODE	2620228	2620228	2620228	2620228
FREESTANDING	-	-	-	-
CONTROL OPTIONS				
ON OFF	✓	✓	✓	✓
ON OFF PRODUCT CODE	2620275	2620275	2620275	2620275
DIMMER	✓	✓	✓	✓
DIMMER PRODUCT CODE	2620276	2620276	2620276	2620276
MASTER REMOTE *	✓	✓	✓	✓
MASTER REMOTE PRODUCT CODE	2620277	2620277	2620277	2620277

Measurements displayed within this catalog are minimum requirements for installation. Bromic takes no responsibility for incorrect or non-compliant installations. All measurements in this catalog are displayed in mm.

* Control up to six zones of heaters with unlimited heaters per zone from a single control. Works with dimming controllers. Control operates within 30m of heaters.

Dimensions

PRODUCT MEASUREMENTS

2000W & 4000W

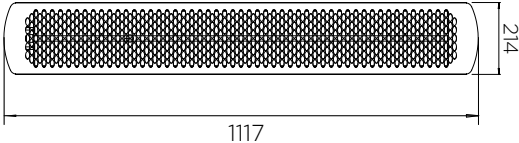

3000W & 6000W

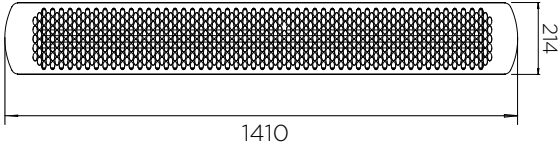

CEILING RECESS

CEILING RECESS FRAME 2000W & 4000W

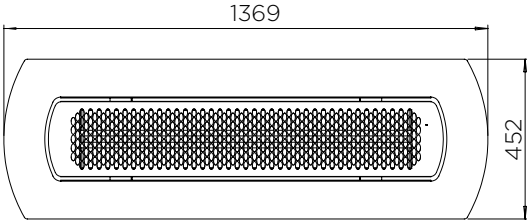

CEILING RECESS FRAME 3000W & 6000W

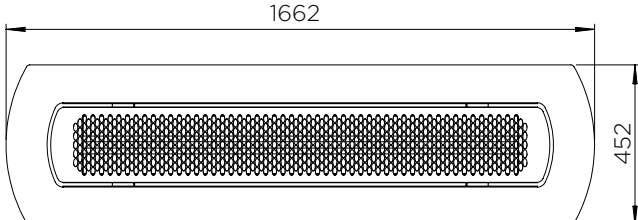

MINIMUM CEILING CAVITY

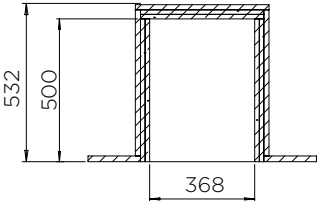

2000W & 4000W

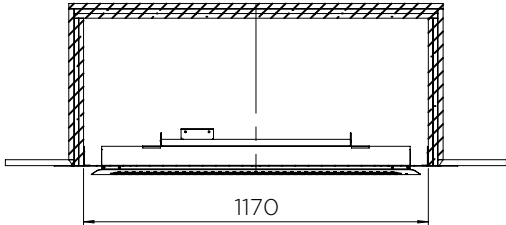

3000W & 6000W

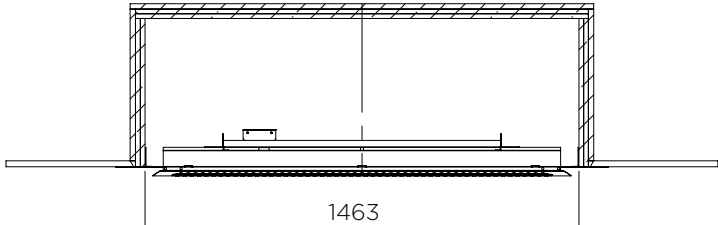

CEILING & WALL MOUNT CLEARANCE

CEILING MOUNT CLEARANCE

2000W & 3000W

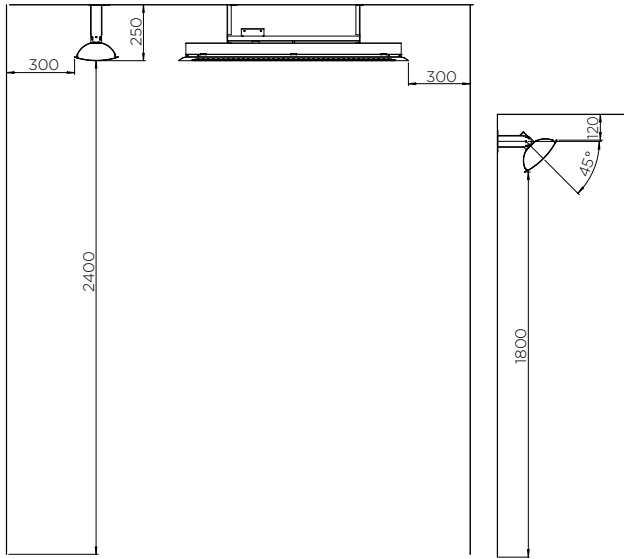

CEILING MOUNT CLEARANCE

4000W & 6000W

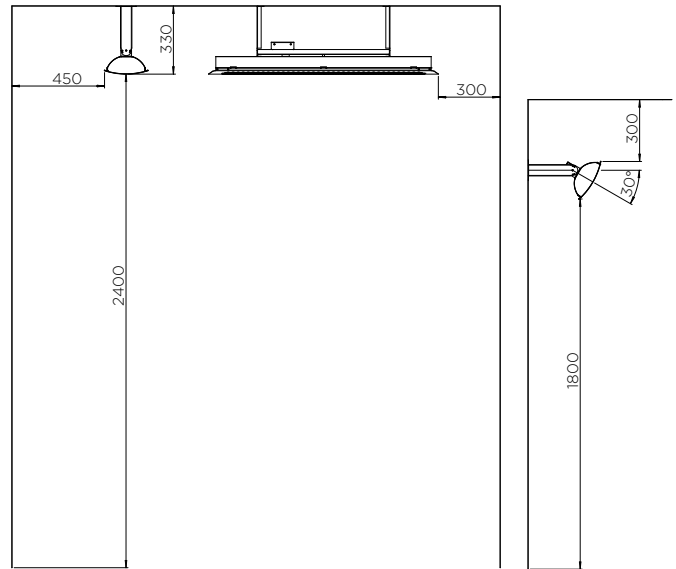

CEILING POLE CLEARANCE

2000W & 3000W

4000W & 6000W

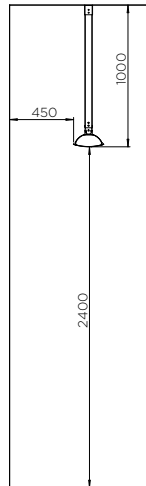
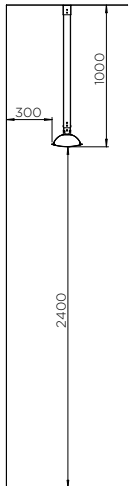

WALL BRACKET (INCLUDED)

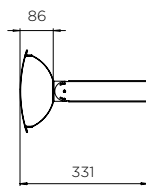
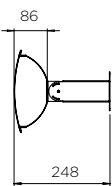

Heat Distribution

HEAT AREA

2000W SERIES

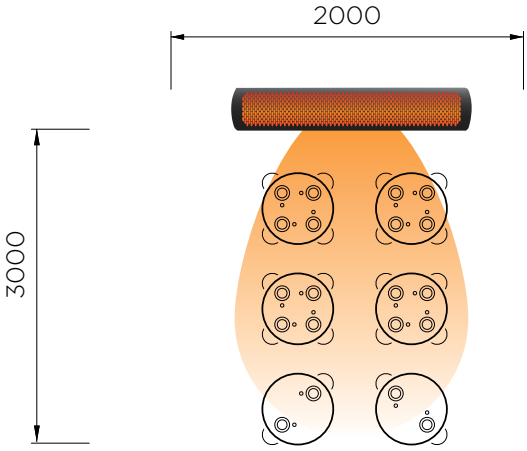

HEATING APPROXIMATELY 6M²
2KW HEATING POWER

3000W SERIES

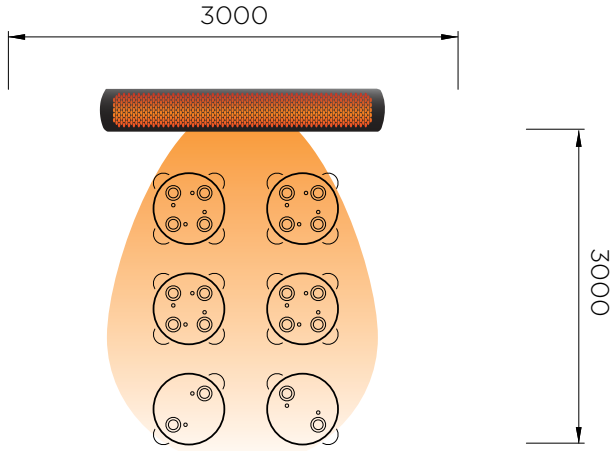

HEATING APPROXIMATELY 9M²
3KW HEATING POWER

4000W SERIES

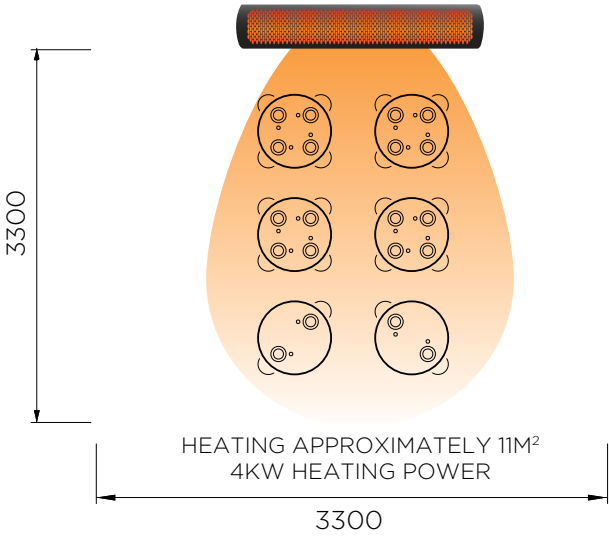

HEATING APPROXIMATELY 11M²
4KW HEATING POWER

6000W SERIES

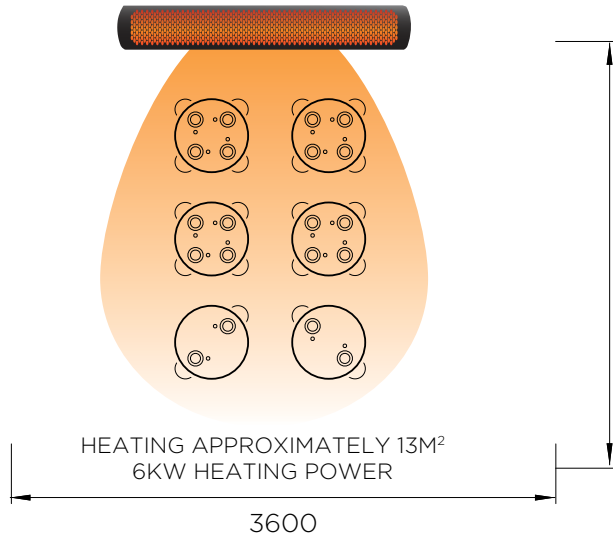

HEATING APPROXIMATELY 13M²
6KW HEATING POWER

*Heat area dependent on ambient temperature and wind. Optimum conditions experienced at approx 15.5°C and in a low wind covered environment.

Features & Benefits

High Performance

Manufactured with a high-temperature coating, stainless-steel construction for longevity of use

Total Mounting Flexibility

Available in wall, ceiling or recessed mounting options.

Angle Bracket

Provides precise directional heat with 15-45 degree rotation angle varying by model

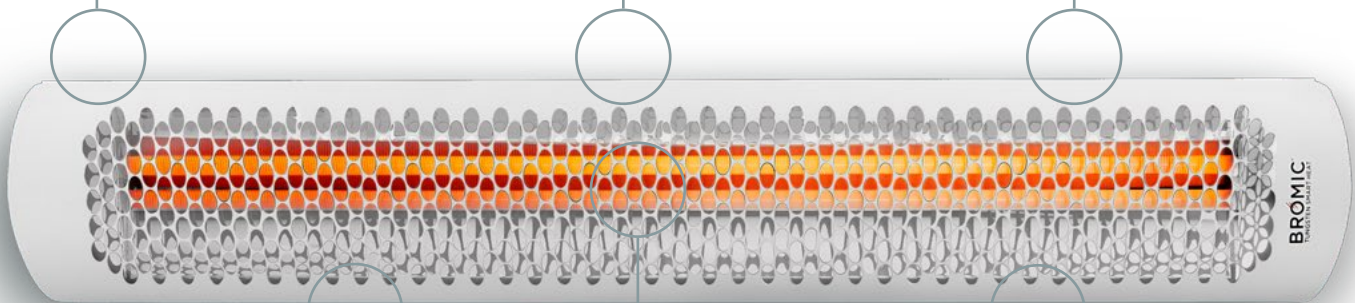

Patented Performance

Directional radiant heat output with superior wind resistance

Unique Design

Honeycomb mesh surface facilitates precise heat distribution

High Quality Element

Thick steel coil housed in translucent fused quartz offers high-heat output

Tungsten Smart-Heat Gas

With its curved screen and durable stainless steel engineered body, the Tungsten Gas heater is a work-horse in providing powerful radiant heat. Available in matte black, with two power output levels (25 MJ & 42 MJ), and in both LPG and natural gas fuel sources, this powerful heater is ideal for well-ventilated large spaces and colder climates. The easy pivot arm allows for greater positioning and directional heat control of up to 20m² with exceptional wind resistance of up to 8mph. With its versatile wall and ceiling mounting options, this heater will keep you warm during any time of the year.



Specifications

Reference the specification guide below to help you select the correct solution for your needs.

MODEL NUMBER	300 SERIES	500 SERIES
PRODUCT CODE	2620330-1 2620331-1	2620340-1 2620341-1
FUEL TYPE	LPG NG	LPG NG
COLOR	BLACK	BLACK
HEAT AREA	12m ²	20m ²
ELECTRICAL CONNECTION	220-240 Va.c.	220-240 Va.c.
MINIMUM FLOOR CLEARANCE	2000MM	2000MM
OUTPUT	25 MJ	42 MJ
MOUNTING OPTIONS		
CEILING MOUNT	✓	✓
WALL MOUNT	✓	✓
RECESSED FLUSH MOUNT	-	-
CEILING POLE MOUNT	✓	✓
FREESTANDING	-	-
CONTROL OPTIONS		
ON OFF	✓	✓
ON OFF PRODUCT CODE	2620275	2620275
DIMMER	-	-
MASTER REMOTE	-	-

Measurements displayed within this catalog are minimum requirements for installation.

Bromic takes no responsibility for incorrect or non-compliant installations.

All measurements in this catalog are displayed in mm.

Dimensions

PRODUCT MEASUREMENTS

500 SERIES

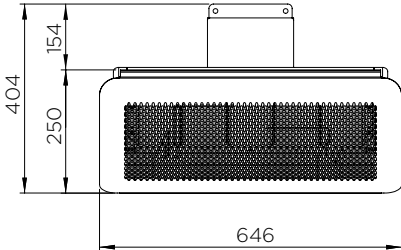

300 SERIES

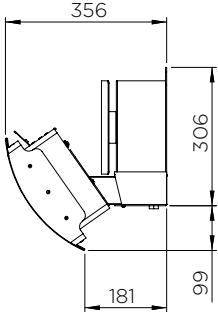
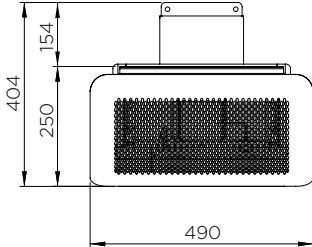

PRODUCT MEASUREMENTS WITH HEAT DEFLECTOR

500 SERIES

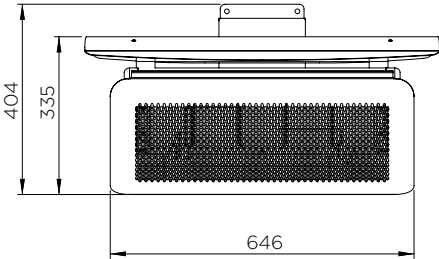

300 SERIES

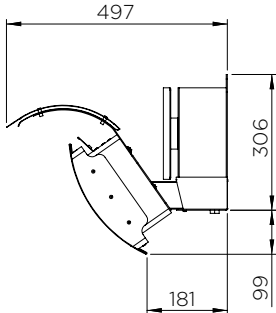
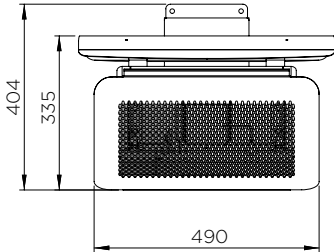

CEILING & WALL MOUNT CLEARANCE

WALL MOUNT CLEARANCE

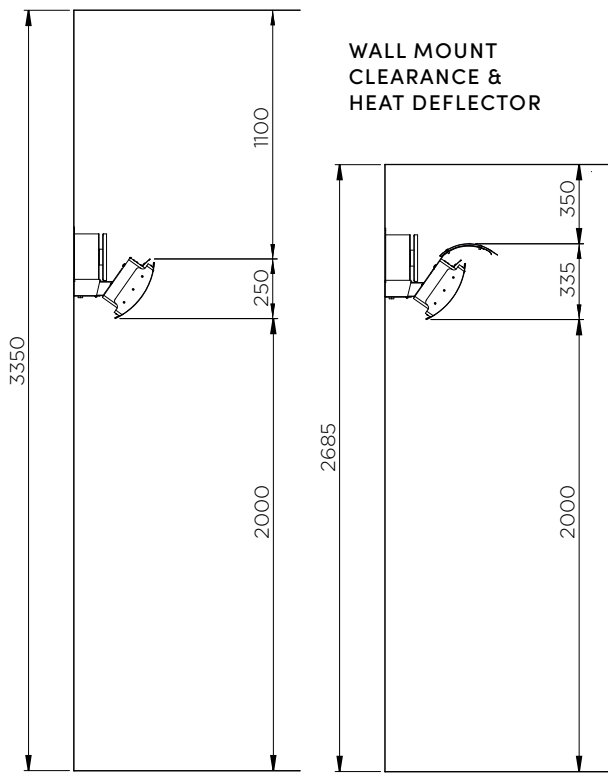

CEILING MOUNT CLEARANCE

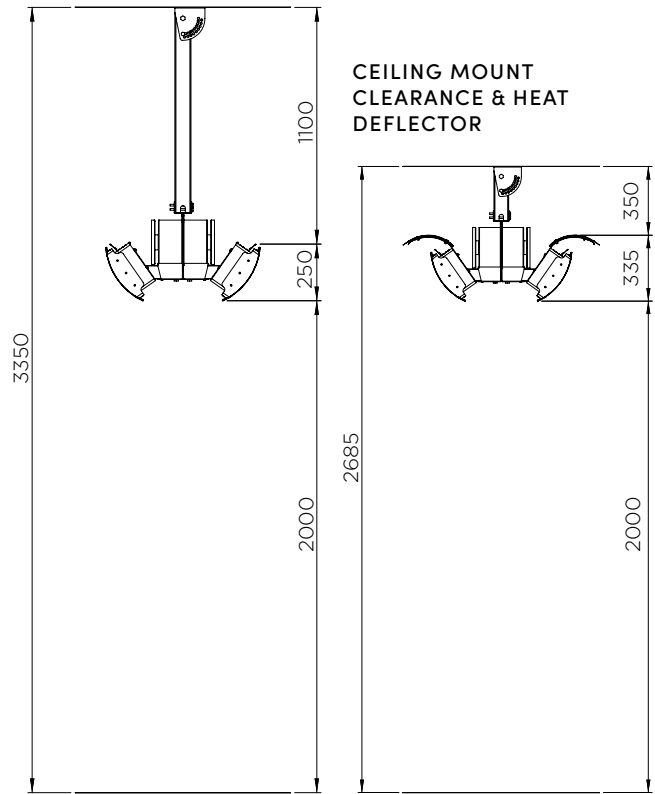

WALL BRACKET

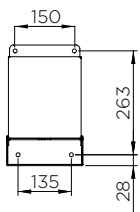

Heat Distribution

HEAT AREA

500 SERIES

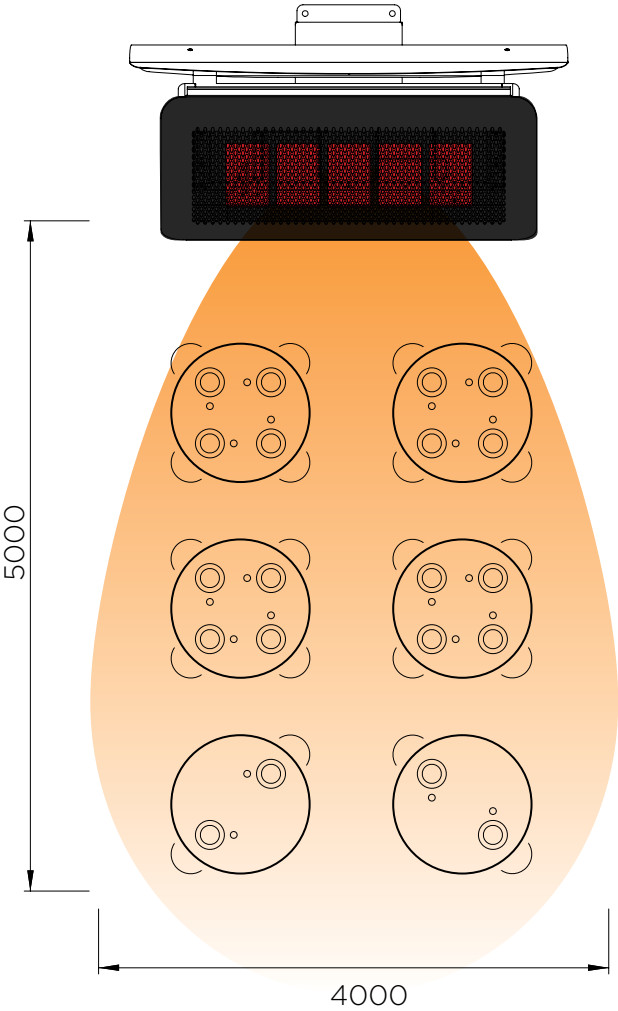

HEATING APPROXIMATELY 20M²
42 MJ HEATING POWER

300 SERIES

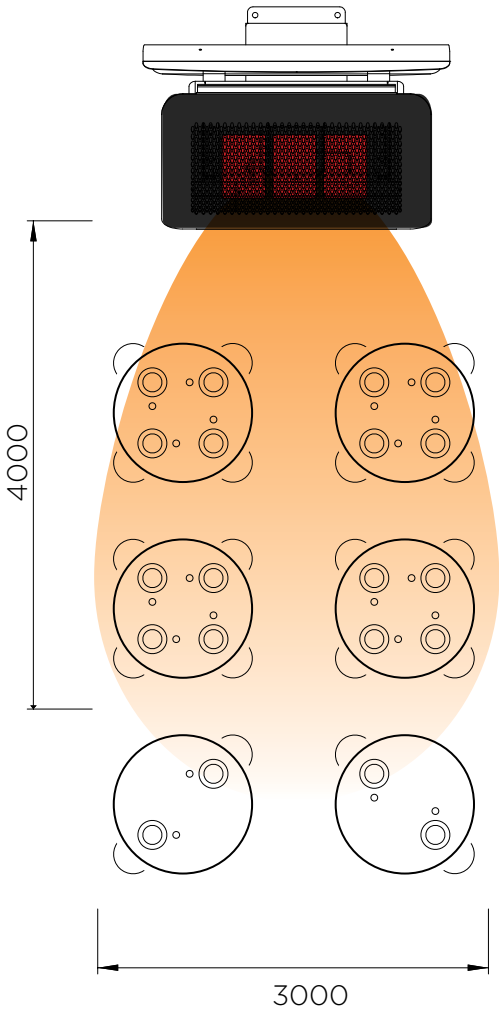

HEATING APPROXIMATELY 12M²
25 MJ HEATING POWER

*Heat area dependent on ambient temperature and wind. Optimum conditions experienced at approx 15.5°C and in a low wind covered environment.

Features & Benefits

Total Mounting Flexibility

Furnished with a complimentary wall mount with control housing, and available with ceiling mounting options ranging from 246mm to 1000mm

Patented Direct Ignition System

Instantaneous ignition, whenever you require it, without the need for a pilot light

Pivot Bracket

Ability to rotate 25 degrees on each side, allowing for directional heat distribution

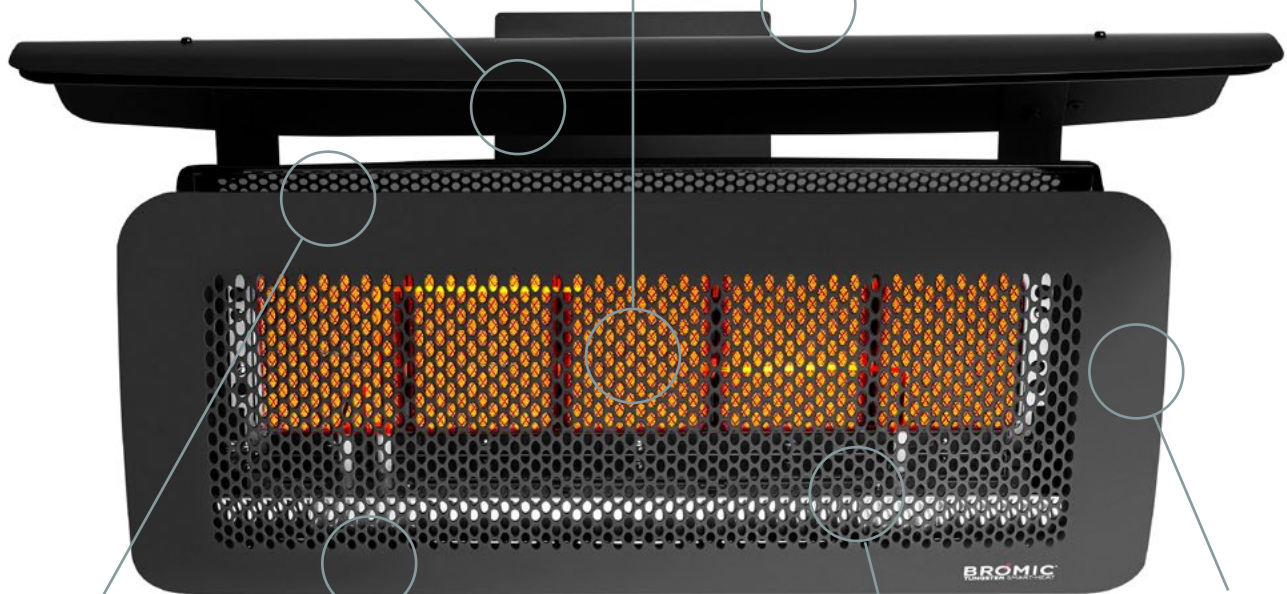

Enhanced Safety Features

Integrated "Flame Failure Safety Shut-off Control" turns the heater off immediately should it not re-ignite

High Performance Construction

Manufactured with a matte black stainless-steel body and slow-release ceramic burners for efficient heat output

Patented Performance

Superior wind resistance

Unique Design

Honeycomb mesh surface enables precise heat distribution

Tungsten Smart-Heat Portable

Featuring an award-winning, modular and maneuverable design, this powerful portable heater is the ideal heating solution for locations without a structure. Available in matte black with a heat output of 40 MJ in both LPG and natural gas fuel sources, this heater creates comfortable environments heating areas of up to 20m². Three times more efficient than traditional mushroom heaters, this highly efficient heater easily overcomes winds of up to 8mph and wastes little to no energy thanks to its use of directional heat, making sure the heat ends up exactly where it's needed.



Specifications

Reference the specification guide below to help you select the correct solution for your needs.

MODEL NUMBER	
PRODUCT CODE	2620350
FUEL TYPE	LPG
COLOR	BLACK
HEAT AREA	20M ²
ELECTRICAL CONNECTION	-
MINIMUM CEILING CLEARANCE	1000MM
OUTPUT	40 Mj
MOUNTING OPTIONS	
CEILING MOUNT	-
WALL MOUNT	-
RECESSED FLUSH MOUNT	-
CEILING POLE MOUNT	-
FREESTANDING	✓
CONTROL OPTIONS	
ON OFF	-
DIMMER	-
MASTER REMOTE	-

Measurements displayed within this catalog are minimum requirements for installation.

Bromic takes no responsibility for incorrect or non-compliant installations.

All measurements in this catalog are displayed in mm.

Dimensions

SIDE & FRONT VIEW

SIDE VIEW

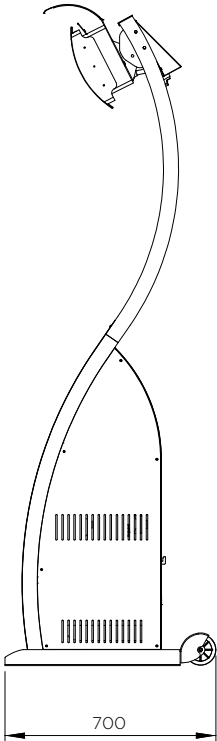

FRONT VIEW

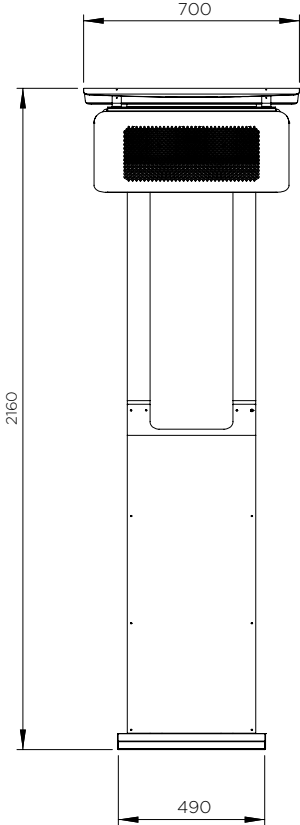

CEILING & WALL CLEARANCE

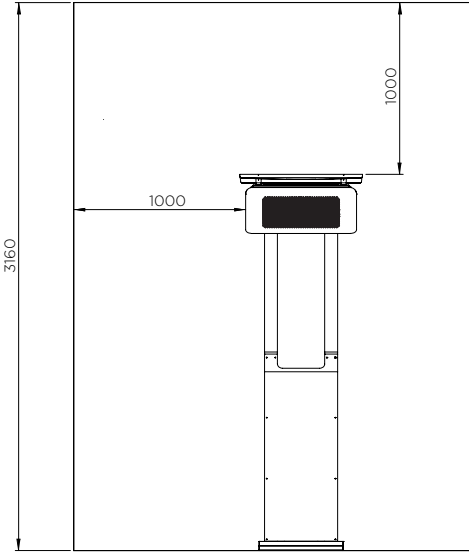
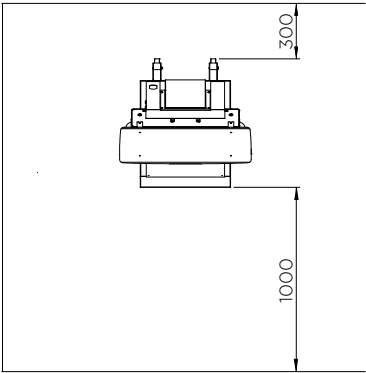

Heat Distribution

HEAT AREA

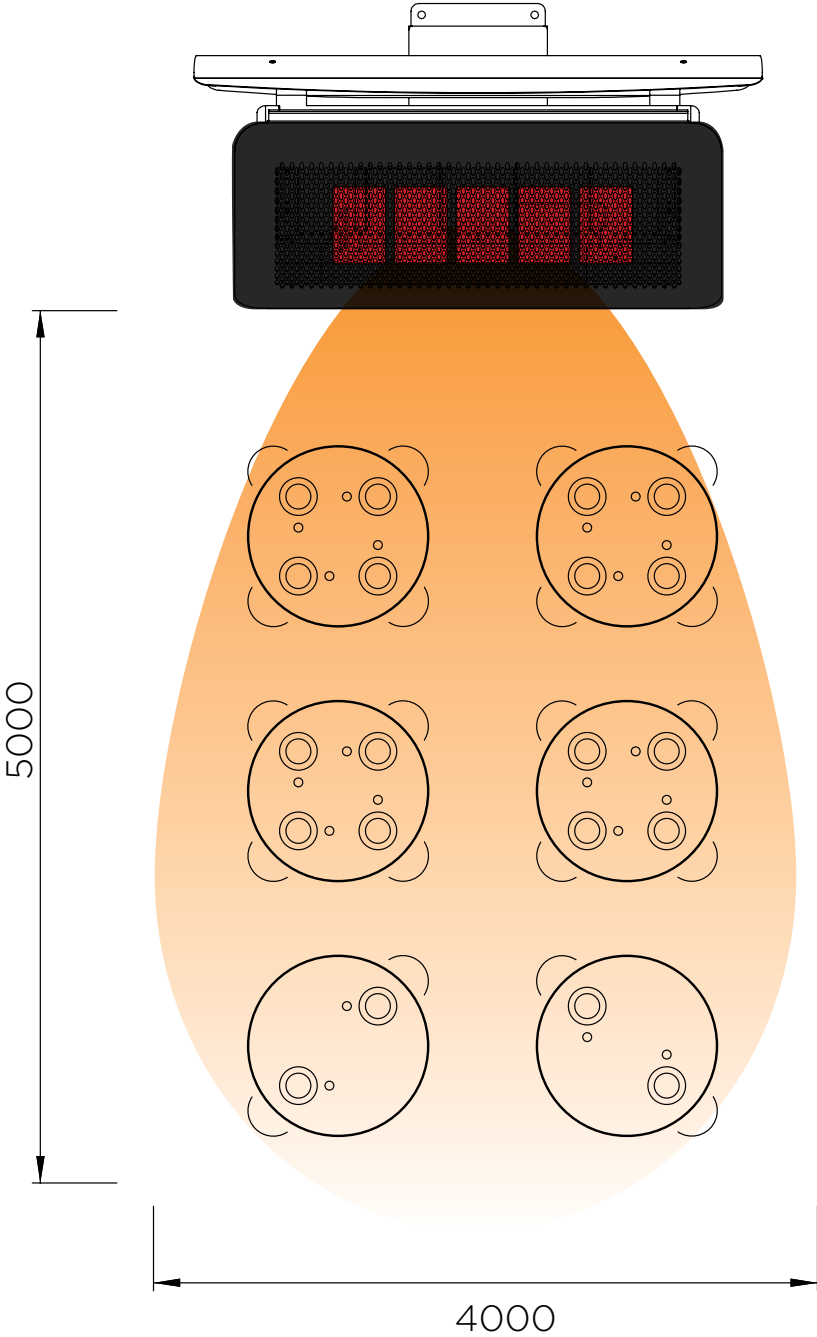

HEATING APPROXIMATELY 20 M² | 40 MJ HEATING POWER

*Heat area dependent on ambient temperature and wind. Optimum conditions experienced at approx 15.5°C and in a low wind covered environment.

Features & Benefits

Angled Bracket

Provides flexibility of heat direction for precise heating

Ceramic Burners

Delivery of optimal heat with minimal heat loss is assured via high-intensity ceramic burners

Safety Feature

Anti tilt shut off

Adjustable Heat Controls

Offers ease of operation and precise heat comfort levels

Modular Design

Easy assembly, dismantling and storage thanks to a functional and pragmatic design

Efficient Heat Output

8 hours of operating time on a single tank of propane!

Easy Maneuverability

Easy mobility even in tighter spaces with an anti-tilt structural design and built-in wheels



Controls

Bromic's control options make the operation of your outdoor heater even more convenient. Choose from simple On/Off remotes to dimmer controls to fully integrated smart home solutions.



On/Off Controller

Bromic's independent 'On/Off' control will let you control up to two electric or four gas heaters across two separate circuits from up to 30m away. The wireless transmitter is fully portable or can be easily mounted with the included double-sided adhesive/screws.



Wireless Dimmer Controller

Move beyond the base-model wireless controller with the Bromic Dimmer Controller. Suitable for our electric heaters, the dimmer control provides the ability to precisely adjust the electric heat output in 1% increments, or quickly jump by 25% increments, from up to 100ft away.



Wireless Master Remote

Invaluable for larger venues, the Wireless Master Remote offers full control over an unlimited number of heaters in up to 6 groups within a 100ft range. Compatible with our Dimmer Controller.

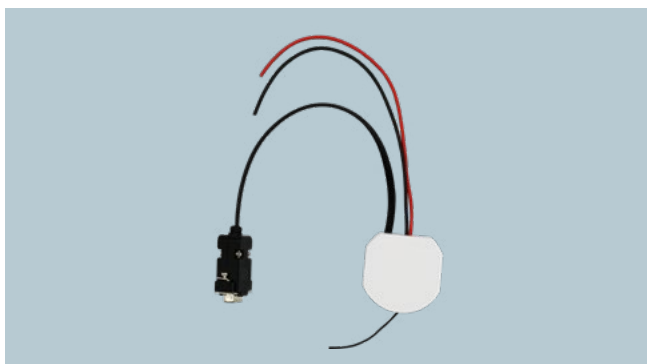

Smart-Heat Link

Pair Bromic's control options with the Smart-Heat Link to create a seamless communication between your outdoor heaters and smart home controls technology. The Bromic Smart-Heat Link requires a RS232 port and is compatible with leading home automation systems, such as Control 4, Crestron, Lutron, Nomad and many more!

Performance, Reliability & *Beauty*

Bromic outdoor heaters are recognized all over the world for superior design and performance. From luxury hotels and leading restaurants to distinguished residential outdoor kitchens and exquisite backyards, Bromic outdoor heaters deliver the comfort and ambiance needed to elevate the outdoors.

Available in our distinctive collections, every Bromic outdoor heater is constructed from premium materials to deliver outdoor heating products that provide the perfect balance of performance, reliability and beauty.



Sustainability

The environment has a heating partner.

Bromic is committed to utilizing sustainable design principles. Leveraging outdoor spaces for dining, working, and congregating is a design priority for leading architects around the world and the global pandemic has taught us that outdoor spaces are some of the safest, healthiest, and most necessary elements in both residential and commercial contexts.

The tenants of sustainability are to reduce consumption of non-renewable resources, minimize waste, and create healthy, productive environments.

SUSTAINABLE DESIGN PRINCIPLES INCLUDE THE ABILITY TO:

- Optimize site potential
- Enhance indoor environmental quality
- Minimize non-renewable energy consumption
- Optimize operational and maintenance practices
- Use environmentally preferable products

Utilizing a sustainable design philosophy encourages decisions at each phase of the design process that will reduce negative impacts on the environment and the health of the occupants, without compromising the bottom line.

We continue our commitment to building increasingly efficient outdoor heaters that don't waste energy by heating the air, but rather, heating people with radiant technology. While many competitors' heaters may last only a season or two, Bromic heaters continue to provide warmth and comfort year-after-year, even in commercial environments.



Explore our collection lineup



Eclipse

Available in seven unique mounting options, including portable, the Eclipse Smart-Heat™ Electric collection adds style, warmth and light to design-focused outdoor spaces.



Platinum

With both gas and electric models to choose from, the Platinum Smart-Heat™ collection features premium ceramic glass fascias and stainless-steel frames for a sleek and timeless look.



Tungsten

Our Tungsten Smart-Heat™ gas and electric outdoor heaters come in a stylish, industrial design with a wide selection of heat output and mounting options, including portable.





Customer feedback has been very good. Most of my customers that have been to other restaurants have commented that the heaters we have installed are the best that they have seen.

MATTHEW MATHUS

Restaurant Manager | HIDE – London, UK



Complimentary Outdoor Heating Design Service

Gas or electric? How many heaters do I need? Where should I mount them? We can help you answer each of these questions. Leverage free, yes, free—professional design services from the technical experts at Bromic Heating.

Your Dedicated Designer

Work one-on-one with a Outdoor Heating design professional from start to finish.

2D Heating Space Map

We will work with your architectural plans or site images to ensure that your space is optimally heated.

Part Order List

From mounting options to smart home controls, we'll detail exactly what you should order. We can even connect you to a retail partner if you desire.

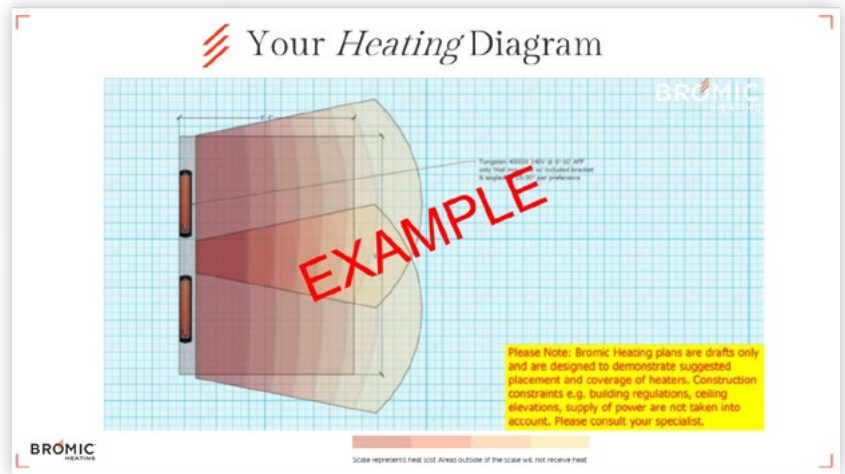

Recommended Heating Solution

For your project, we recommend the Tungsten Smart-Heat™ Electric **2000W/3000W/4000W/6000W in Black/White**

MODEL	6000W Series
Fuel Type	Electric
Color	Black
Model #	2620265
Heat Area	15m ²
Rated Current & Voltage	240V/25A 277V/21.56A
Minimum Floor Clearance	Wall 1800mm Ceiling 2400mm

[PRODUCT SPECS HERE](#)

[VIEW CASE STUDIES](#)

BROMIC HEATING

REQUEST YOUR COMPLIMENTARY DESIGN



I've owned this patio heater for more than a year and am very happy with it so far. Unlike the more traditional "mushroom" style standing propane heaters, it directs the heat into a specific direction.

HOMEOWNER

United States



Contact

BROMIC[®]
HEATING

AIA
Continuing
Education
Provider

Expand your expertise in designing outdoor heating projects with our AIA certified online courses.

BROMICUNIVERSITY.COM

UNITED STATES

7595 Irvine Center Drive, Ste. 100
Irvine, California 92618

1 (800) 301-1293

EUROPE

Newtonlaan 115
3584 BH Utrecht
Netherlands

AUSTRALIA

10 Phiney Place
Ingleburn NSW 2565

FOLLOW US:



BROMIC.COM.AU