

## PLATINUM SMART-HEAT™ GAS

The Platinum Smart-Heat™ Gas heater series spreads heat and comfort evenly in all areas, with a soft and soothing red glow. Built with pure premium materials and designed with elegance, there is no compromise on performance, reliability and beauty.



500 SERIES



300 SERIES

# SPECIFICATIONS

Reference the specification guide below to help you select the correct solution for your needs.

MODEL NUMBER	300 SERIES	500 SERIES
FUEL TYPE	LPG   NG	LPG   NG
COLOUR	BLACK	BLACK
HEAT AREA	12M <sup>2</sup>	20M <sup>2</sup>
MINIMUM FLOOR CLEARANCE	2,000MM	2,000MM
OUTPUT	25 MJ	42MJ
<b>MOUNTING OPTIONS</b>		
CEILING MOUNT	✓	✓
WALL MOUNT	✓	✓
RECESSED   FLUSH MOUNT	-	-
CEILING POLE MOUNT	✓	✓
FREESTANDING	-	-
<b>CONTROL OPTIONS</b>		
ON   OFF	✓	✓
DIMMER	-	-
MASTER REMOTE	-	-

# DIMENSIONS

With a wide range of sizes available, find the ideal heater to suit your outdoor space.

## FRONT PROFILE

## + HEAT DEFLECTOR

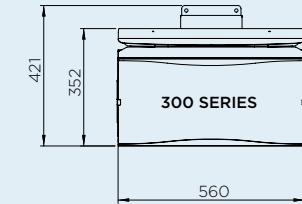
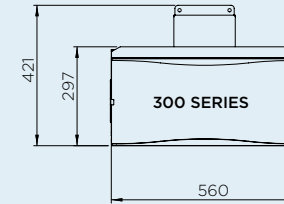
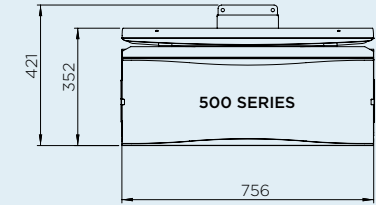
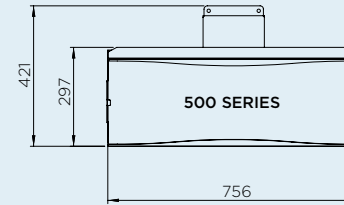

## SIDE PROFILE

## + HEAT DEFLECTOR

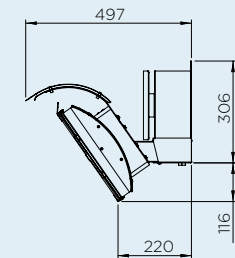
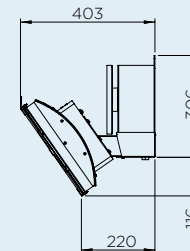

Measurements displayed within this document are minimum requirements for installation. Bromic takes no responsibility for incorrect or non-compliant installations. All measurement in this document are displayed in mm.

# MOUNT OPTIONS

With a wide array of mounting options, Bromic offers solutions to compliment any décor and provide functionality for ambiance and comfort.

## WALL MOUNT

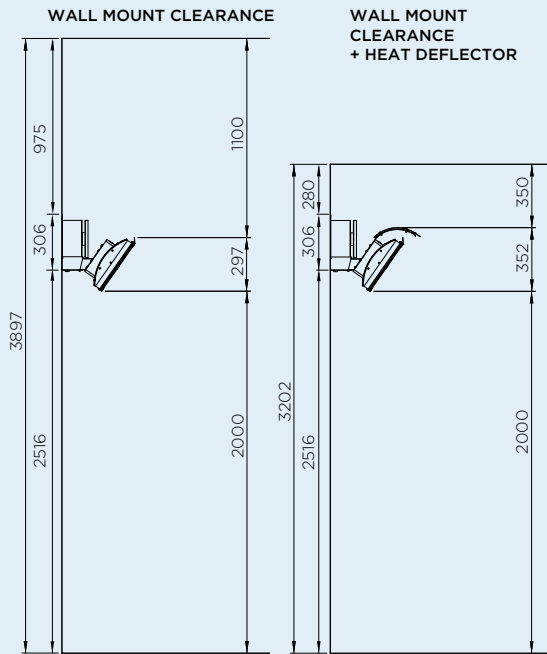

## CEILING MOUNT

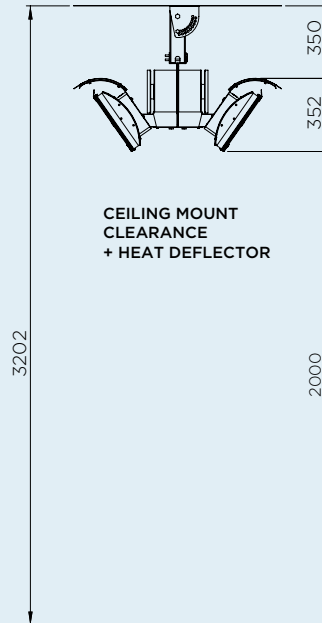

## WALL BRACKET

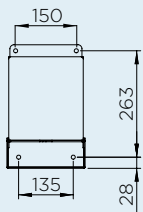

# HEATING REACH

Creating ideal comfort levels, Bromic heaters offer a variety of heat distribution options to suit your outdoor heating needs.

## 500 SERIES

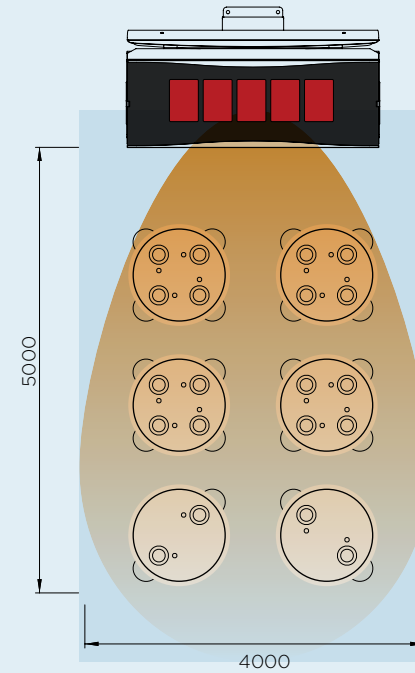

HEATING APPROXIMATELY 20M<sup>2</sup>  
42MJ HEATING POWER

## 300 SERIES

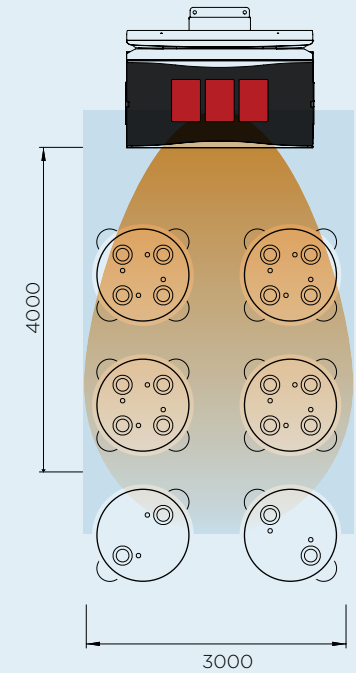

HEATING APPROXIMATELY 12M<sup>2</sup>  
25MJ HEATING POWER

## CONTROL OPTIONS



ON | OFF CONTROL



MASTER REMOTE



EXTEND YOUR COMFORT OUTDOORS  
WITH THE SUPERIOR HEAT AND  
AWARD-WINNING DESIGN OF OUR  
SMART-HEAT™ OUTDOOR HEATERS.

---

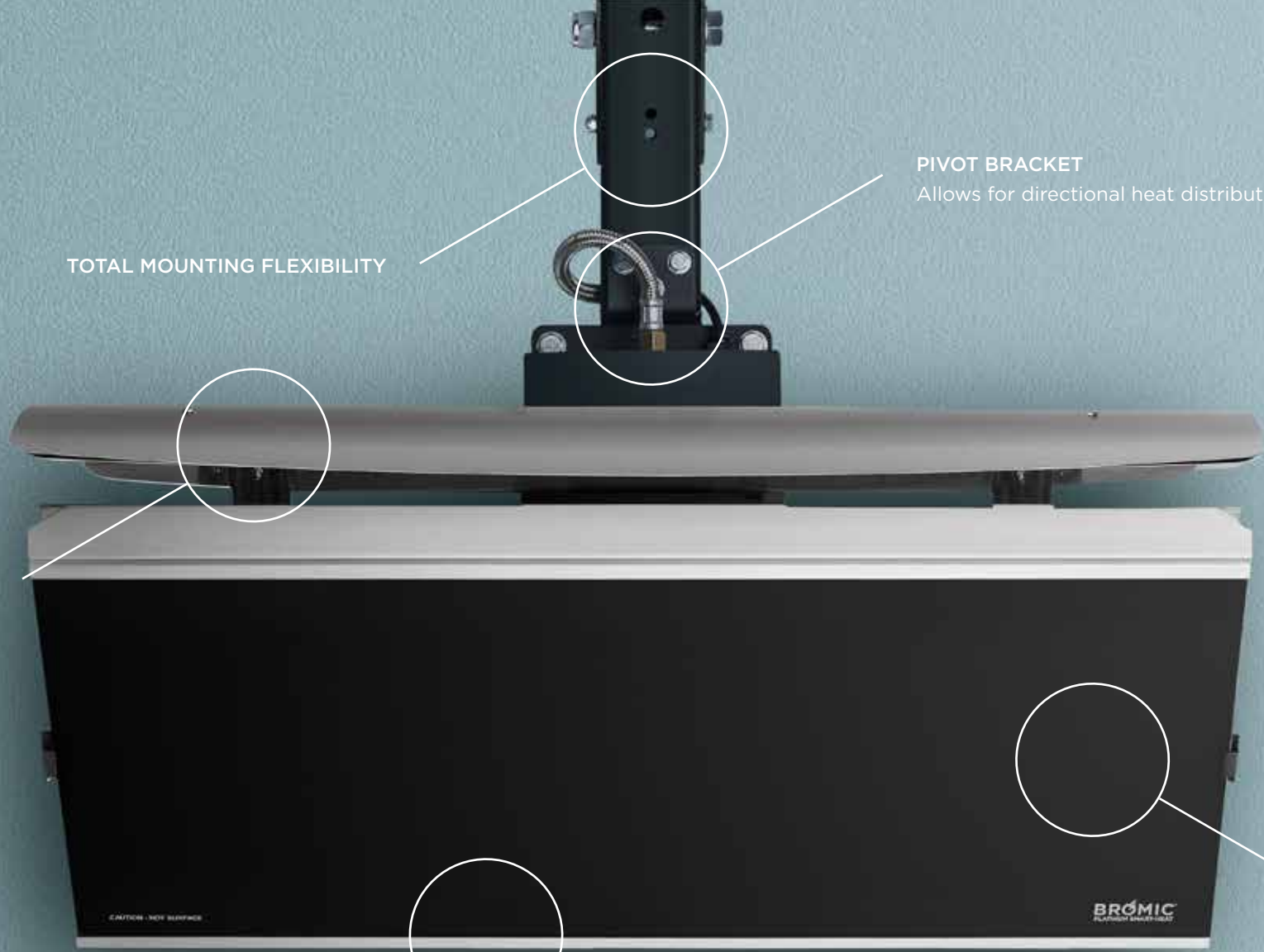

**PIVOT BRACKET**  
Allows for directional heat distribution

**TOTAL MOUNTING FLEXIBILITY**

**PATENTED PERFORMANCE**  
Superior wind resistance

**UNIQUE DESIGN**  
Ceramic fascia enables even heat distribution

**PREMIUM CONSTRUCTION**  
High performing stainless steel for long lasting and durable use

**BROMIC.COM/HEAT**

ASIA PACIFIC | NORTH AMERICA | EUROPE

Bromic pursues a policy of continuing improvement in design and performance of its products. The right is therefore reserved to vary specifications without notice.  
03.2021