

apuro

Planetary Mixer

Instruction manual

**INDUSTRY
KITCHENS**

www.industrykitchens.com.au 1800 611 058



Model:

FU137-A / FU138-A / FU139-A

Safety Instructions

Read carefully and keep for future reference.

Warning: The planetary mixer is a dangerous appliance and must only be used by trained personnel in accordance with these instructions.

- Position on a flat, stable surface.
- A service agent/qualified technician should carry out installation and any repairs if required. Do not remove any components on this product.
- Consult Local and National Standards to comply with the following:
 - Health and Safety at Work Legislation
 - Fire Precautions
 - Wiring Regulations
 - Building Regulations
- Always stand **BEHIND** the safety guard when operating the appliance.
- **DO NOT** place hands near the rotating attachments when in use. This can result in severe injury.
- **DO NOT** remove food from the appliance until the mixing attachments have come to a complete stop.
- **DO NOT** immerse the appliance in water.
- **DO NOT** attempt to mix items that this machine is not designed for. This can damage the mixing attachments.
- **DO NOT** use with a damaged mixing attachment.
- **DO NOT** bypass the safety interlocks.
- Always switch off and disconnect the power supply to the appliance when not in use.
- **NEVER** leave the appliance unattended when in use.

- The appliance is heavy. Take care when moving.
- This appliance is not intended for use by persons (including children) with reduced physical, sensory or mental capabilities, or lack of experience and knowledge, unless they have been given supervision or instruction concerning use of the appliance by a person responsible for their safety.
- Children should be supervised to ensure that they do not play with the appliance.
- Keep all packaging away from children. Dispose of the packaging in accordance to the regulations of local authorities.
- If the power cord is damaged, it must be replaced by an Apuro agent or a recommended qualified technician in order to avoid a hazard.
- Never use accessories which are not recommended by the manufacturer. They could pose a safety risk to the user and might damage the appliance. Only use original parts and accessories, or your warranty will be void.
- Apuro recommend that this appliance should be periodically tested (at least annually) by a Competent Person. Testing should include, but not be limited to: Visual Inspection, Polarity Test, Earth Continuity, Insulation Continuity and Functional Testing.

Product Description

FU137-A - 10L Digital planetary mixer

FU138-A - 20L Digital planetary mixer

FU139-A - 30L Digital planetary mixer

The Apuro Planetary Mixer is a free standing machine that consists of a large bowl mounted below a motor and a gear box to which a mixing tool can be attached.

The Apuro Planetary Mixer has been designed to mix a range of foodstuffs, varying from cream to dough.

Introduction

Please take a few moments to carefully read through this manual. Correct maintenance and operation of this machine will provide the best possible performance from your Apuro product.

Pack Contents

The following is included:

- Apuro Planetary Mixer
- Mixing Bowl
- Spiral Dough Hook
- Beater
- Whisk
- Instruction Manual

Apuro prides itself on quality and service, ensuring that at the time of unpacking the contents are supplied fully functional and free of damage.

Should you find any damage as a result of transit, please contact your Apuro dealer immediately.

Installation

Ensure the location of the Planetary Mixer is capable of supporting its weight.

WARNING: The Planetary Mixer is very heavy, care must be taken when moving.

If the appliance is intended to be positioned on a worktop, please ensure it is secured in position (for FU137-A, FU138-A).

FU139-A is designed to be a Floor Standing Mixer and should not be placed on a worktop due to its heavy weight.

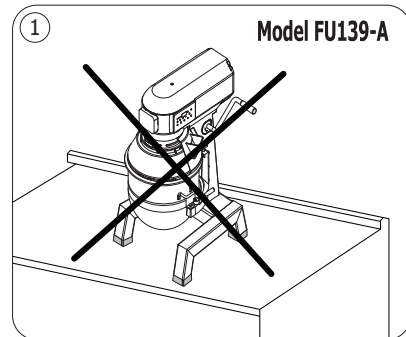

Assembly



WARNING:

- Ensure the appliance is switched off and disconnected from power supply before assembly/disassembly.
- Apuro accept no responsibility for any injury caused by incorrect assembly of this appliance.
- The bowl must be attached and raised into position prior to starting the Planetary Mixer.

Clean all removable parts well (See section "Cleaning, Care & Maintenance").

The appliance will not start unless:

- The bowl is raised and secured in place.
- Safety guard is closed.
- Unit is plugged in and timer is enabled.

How to install the rubber feet

1. Remove all packaging from the appliance.
2. Remove the wooden pallet from the machine (Loosen the four bolts at the bottom of the wooden pallet).
3. Take out the rubber feet from the bowl.
4. Add the rubber feet to the feet of the machine.

Note: A minimum of two people should be used to install the rubber feet.

Note: Once the rubber feet have been installed, ensure the machine is stable and level to reduce vibration during operation.

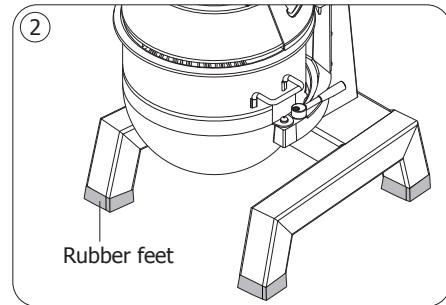

Fitting/Removing the Bowl

1. Turn Off the appliance and disconnect from power supply.
 2. Open the safety guard by turning it to the left.
 3. Mount the desired mixer attachment.
 4. Mount the bowl and raise it fully with the lever.
 5. Secure the bowl with the locking handles on both sides (for FU138-A, FU139-A only).
 6. Close the safety guard.
- Reverse the procedure to remove the bowl.

Note: Ensure the bowl is completely raised and secured or the mixer will not work.

Note: Regularly grease the bowl lift mechanism to ensure smooth operation.

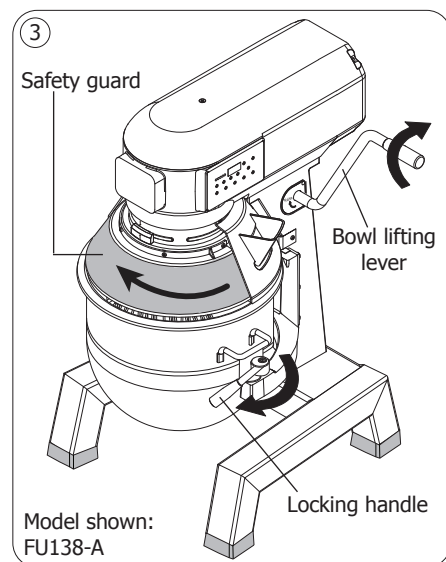

Operation

Warning: Ensure that these instructions have been read thoroughly and the operation of the appliance is fully understood before use.

Warning: All personnel must be fully trained on the operation and safety precautions of the Planetary Mixer.

Warning: Always ensure the appliance is turned off and unplugged before placing hands in the mixing bowl.

Aligning/closing the safety guard

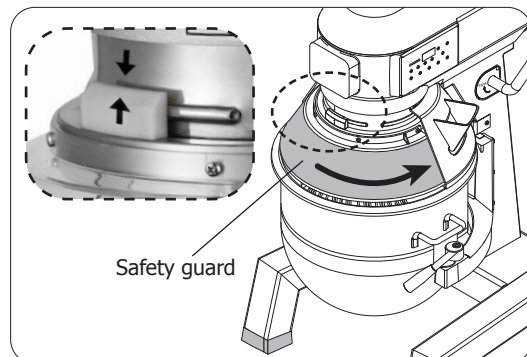

The safety guard needs to be fully closed in order for the appliance to operate. Please ensure the arrow markings on the guard and mixer are aligned as indicated.















Changing the Mixer Attachment

1. Turn Off the appliance and disconnect from power supply.
2. Open the safety guard by turning it to the left.
3. Lower the bowl with the lever.
4. Push the mixer attachment up and to the left to release.
5. Insert the desired attachment. Push up and to the right to lock it into place.
6. Raise the bowl and lock in place.

Apuro recommend the following uses for each attachment:

Speed level	1	2	3	4	5
RPM (Rotation per minute)	400	600	700	1000	1250
 Spiral Dough hook	Intended use: Heavy mixes dough, pie pastry, etc. Suitable speed: Low				
 Beater		Intended use: Firm mixes light pastry, cake/ biscuit mix, icings, fillings and mashed vegetables Suitable speed: Medium			
 Whisk			Intended use: Light mixes whipped cream, mayonnaise, egg whites, pancakes and soufflés Suitable speed: Medium or High		







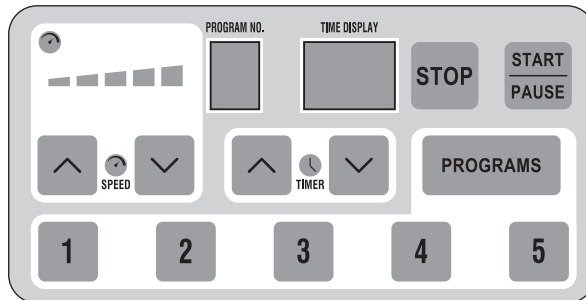

If necessary to manually change the default speed settings, follow below operations:

1. When appliance is in Standby/not in operation, press down both speed buttons   to enter speed adjustment mode. The speed level code will be shown.
2. Press the time buttons   to select the desired speed level number.
3. Press the speed button   to confirm and show the settings of the current speed level.
4. Press the time buttons   to select the desired setting.
5. Press the speed button   to save the setting and exit, Or press the speed button   not to save the settings and back to normal mode.







Speed level	Speed level code on display	Factory setting	Setting range	RPM Description
Level 1	P 01	3	2 ~ 18	Total rotation per minute = Setting number x 100. For example, when the setting number '5' is displayed, the total RPM will be 500 (that is, 5x100); When setting '5.' is displayed, the total RPM will be 550 (the red dot illuminating on the time display means an extra 50 rotation).
Level 2	P 02	4	2 ~ 18	
Level 3	P 03	6	2 ~ 18	
Level 4	P 04	7	2 ~ 18	
Level 5	P 05	9	2 ~ 18	

Knowing the control panel



Symbol	Name	Function
	Program display	To show the current working mode: <ul style="list-style-type: none"> • While in normal mode, showing "—". • While in programmed mode, showing program number 1~5. • While in program setting mode, showing program number and stage number in turn.
	Time display	To show the working time or settings
	Speed indicator lights	To show the current working speed: <ul style="list-style-type: none"> • 1 light ON means speed level 1; • 2 lights ON means speed level 2; ... • 5 lights ON means speed level 5.
	Speed buttons	To increase/decrease the speed setting
	Time buttons	To increase/decrease the time setting
	Stop button	To stop the current mode and switch mixer off
	Start/Pause button	To start mixing or pause operation
	Programming button	To save/amend favourite programs
	Program number buttons	Press a number button to run the relative program

Mixing under the normal mode

1. Open the safety guard. **(Ensure the safety guard is fully closed or the mixer will not work.)**
2. Fill the bowl then close the safety guard.
3. Connect the appliance to the mains power supply. The appliance is energized and enters Standby.
4. Set the mixing speed and time with the speed buttons    and time buttons   .

Note: Apuro recommend that you start with the slowest speed and increase the speed gradually as necessary.

Tip for the time display:

- If the set time is less than 1 minute, it will be shown in unit of seconds.
- If the set time is more than 1 minute, it will be shown in unit of minutes and the red dot on the time display will start to illuminate.
- When the set time is more than 99 minutes, “—” will be shown.

5. Press  to begin mixing. The program display will flash to indicate the motor is running.

Note: If the appliance is straining to mix, turn the appliance Off and remove some of the contents in the bowl before restarting.

6. When the set time expires, the appliance stops automatically.
7. After use, press  to switch off then unplug the appliance.

Mixing Capacity

Model	Bowl Volume	Max Flour	Max Dough
FU137-A	10L	2kg	3.2kg
FU138-A	20L	5kg	8kg
FU139-A	30L	7.5kg	11.3kg

Overload protection

The appliance is featured with overload protection. In case of overload, the appliance will stop working automatically.

1. Switch off and unplug the mixer.
2. Wait to let the mixing attachment come to a full stop.
3. Open the safety guard and reduce the load in the mixing bowl.
4. Close the safety guard and restart.







Note: In the event of a power cut the Overload protection will cut in to prevent the appliance from restarting automatically when power is restored.

Note: Always disconnect the Planetary Mixer from the power supply when not in use.

Programming function

Featured with a programming function, the appliance can save and store favourite programs allowing for consistent results and quick operation.

Creating/Saving favourite programs

1. When appliance is in Standby/not in operation, simultaneously press down **PROGRAMS** and a program number to enter programming mode. The program display will show the program number and stage A in turn.
2. Press    buttons and    buttons to set the speed and time for Stage A.
3. Press **PROGRAMS** to confirm stage A settings and start to set Stage B.
4. Repeat until Stage E is programmed.
5. Press **PROGRAMS** to confirm.
6. Repeat to set more programs. Up to 5 programs can be set.

Running a saved program

- When appliance is in Standby/not in operation, press a program number button. The program number will be shown on the program display.
- Each program consists of 5 stages (Stage A~E) and every stage can be set with speed and time individually.
- When in mixing, the appliance starts from stage A. When stage A ends, stage B starts automatically... After Stage E ends, the appliance stops automatically and backs to stage A.
- While in operation, the program display will alternatively show the current program number and stage number.
- When going to a stage while its speed is 0, the process will pause and next stage settings will be shown. Press  to continue.

Mixing under the programmed mode

1. Press a desired program number button.
2. Press  to start mixing.
3. When the set time of the program expires, the appliance will stop automatically.

Cleaning, Care & Maintenance

- Always turn off the mixer and disconnect from the power supply before cleaning.
- Use warm soapy water to clean the bowl and mixing attachments. Do not use abrasive cleaning chemicals as these can leave harmful residues.
- Clean the exterior of the appliance with a damp cloth.
- Dry all parts thoroughly after cleaning.
- Do not use jet/pressure washers to clean the appliance.
- Clean the appliance regularly.

Troubleshooting

A qualified technician must carry out repairs if required.

Fault	Probable Cause	Solution
The appliance is not working	The unit is not switched on	Check unit plugged in correctly and switched on
	Plug or lead is damaged	Replace Plug or lead
	Mains power supply fault	Check mains power supply
	Overload protection has been activated	See the section "Overload protection"
	Safety Guard not closed	Close Safety Guard fully
	Bowl not fully raised and secured	Ensure the Bowl is raised fully and secured in place
Bowl will not fit back in to place	Bowl pins or surrounding area clogged with mix	Clean the appliance
The appliance is overheating	Mixing bowl is overloaded	Turn off the appliance and empty some of the contents
	The appliance has been operating for too long	Turn off the appliance and allow to cool down for 30 minutes
The appliance is noisy	Bowl or mixing attachment not correctly fitted	Remove and refit bowl/mixing attachment
	Worn bearings/damaged gears	Call Apuro agent or qualified Technician
	Grease has dried up in the gearbox	Call Apuro agent or qualified Technician
The mixing attachment fails to rotate properly	The belt has become loose	Call Apuro agent or qualified Technician
Oil leakage	Sealing rings are worn out	Call Apuro agent or qualified Technician
Mixing speed slows down	Mixing bowl is overloaded	Turn off the appliance and empty some of the contents
	Wrong mixing attachment used	Switch off and select a suitable attachment

Error code	Probable Cause	Solution
E	Problem with PCB	Call Apuro agent or qualified Technician to replace PCB
E1	Input voltage too high	Check the input voltage complies with that listed on the rating plate
E2	Safety guard is not fully aligned and in closed position	Align the marked arrows on the guard and appliance
E3	Hardware overcurrent	Check wires connection between motor and PCB, or replace PCB. All this must be carried out by a qualified Technician
E5	Current overload	Reduce load in mixing bowl then restart. If problem persists, call Apuro agent or qualified Technician
E6	Problem with motor	Check wires connection between motor and PCB, or replace motor. All this must be carried out by a qualified Technician
E7	Motor lock protection	Reduce load in mixing bowl then restart. If problem persists, call Apuro agent or qualified Technician
		Check wires connection between motor and PCB. This must be carried out by a qualified Technician

Technical Specifications

Note: Due to our continuous improvement process, the product specifications are subject to change without notice.

Model	Voltage	Power	Current	Dimensions H x W x D mm	Weight (kg)	Bowl Volume
FU137-A	220-240V~ 50-60Hz	750W	4A	635 x 475 x 420	31.2kg	10L
FU138-A		1100W	6A	794 x 558 x 555	49.2kg	20L
FU139-A		1500W	9A	1142 x 611 x 579	113.6kg	30L

Electrical Wiring

The plug is to be connected to a suitable mains socket.

This appliance is wired as follows:

- Live wire (coloured brown) to terminal marked L
- Neutral wire (coloured blue) to terminal marked N
- Earth wire (coloured green/yellow) to terminal marked E

This appliance must be earthed.



If in doubt consult a qualified electrician.

Electrical isolation points must be kept clear of any obstructions. In the event of any emergency disconnection being required they must be readily accessible.

Compliance

The product must not be disposed of as household waste. To help prevent possible harm to human health and/or the environment, the product must be disposed of in an approved and environmentally safe recycling process. For further information on how to dispose of this product correctly, contact the product supplier, or the local authority responsible for waste disposal in your area.

Apuro parts have undergone strict product testing in order to comply with regulatory standards and specifications set by international, independent, and federal authorities.



Apuro products have been approved to carry the following symbol:

All rights reserved. No part of these instructions may be produced or transmitted in any form or by any means, electronic, mechanical, photocopying, recording or otherwise, without the prior written permission of Apuro. Every effort is made to ensure all details are correct at the time of going to press, however, Apuro reserve the right to change specifications without notice.

DECLARATION OF CONFORMITY

• Conformiteitsverklaring • Déclaration de conformité • Konformitätserklärung • Dichiarazione di conformità •
• Declaración de conformidad • Declaração de conformidade

Equipment Type • Uitrustingstype • Type d'équipement • Gerätetyp • Tipo di apparecchiatura • Tipo de equipo • Tipo de equipamento	Model • Modèle • Modell • Modello • Modelo • Malli
10L Digital Planetary Mixer 20L Digital Planetary Mixer 30L Digital Planetary Mixer	FU137-A FU138-A FU139-A
Application of Territory Legislation & Council Directives(s) Toepassing van Europese Richtlijn(en) • Application de la/des directive(s) du Conseil • Anwendbare EU-Richtlinie(n) • Applicazione delle Direttive • Aplicación de la(s) directiva(s) del consejo • Aplicação de directiva(s) do Conselho	Electrical Safety IEC 60335-1:2010 +A1:2013 +A2:2016 IEC 60335-2-64:1997 +A1:2000 Electro-Magnetic Compatibility (EMC) EN IEC 55014-1:2021 EN IEC 55014-2:2021 EN IEC 61000-3-2: 2019 +A1:2021 EN 61000-3-3: 2013 +A1:2019 +A2:2021
Manufacturer Name • Naam fabrikant • Nom du producteur • Name des Herstellers • Nome del produttore • Nombre del fabricante • Nome do fabricante	Apuro

I, the undersigned, hereby declare that the equipment specified above conforms to the above Territory Legislation, Directive(s) and Standard(s).

Ik, de ondergetekende, verklaar hierbij dat de hierboven gespecificeerde uitrusting goedgekeurd is volgens de bovenstaande Richtlijn(en) en Standaard(en).

Je soussigné, confirme la conformité de l'équipement cité dans la présente à la / aux Directive(s) et Norme(s) ci-dessus
 Ich, der/die Unterzeichnende, erkläre hiermit, dass das oben angegebene Gerät der/den oben angeführten Richtlinie(n) und Norm(en) entspricht.

Il sottoscritto dichiara che l'apparecchiatura di sopra specificata è conforme alle Direttive e agli Standard sopra riportati.
 El abajo firmante declara por la presente que el equipo arriba especificado está en conformidad con la(s) directiva(s) y estándar(es) arriba mencionadas.

Eu, o abaixo-assinado, declaro que o equipamento anteriormente especificado está em conformidade com a(s) anterior(es) Directiva(s) e Norma(s)

Date • Data • Date • Datum • Data •
 Fecha • Data

Signature • Handtekening • Signature
 • Unterschrift Firma • Firma •
 Assinatura

Full Name • Volledige naam • Nom et prénom • Vollständiger Name • Nome completo • Nombre completo • Nome por extenso

Position • Functie • Fonction • Position
 • Qualifica • Posición • Função

Manufacturer Address • Adres fabrikant • Adresse du producteur • Anschrift des Herstellers • Indirizzo del produttore • Dirección del fabricante • Morada do fabricante

10th Nov 2023

DocuSigned by:

Ashley Hooper

B39382C9FD9C478

Ashley Hooper

Group Head of Product Quality & Compliance

**Fourth Way,
 Avonmouth,
 Bristol,
 BS11 8TB
 United Kingdom**

DocuSigned by:

Brendan Denmeade

388FAD00DFE8483

Brendan Denmeade

Commercial Manager/ Responsible Supplier

**15 Badgally Road,
 Campbelltown
 NSW 2560**





FU137-A_FU138-A_FU139-A_A5_v2_2024/11/07