

apuro

**Heated Banquet
Cabinet**

Instruction manual



**Model:
CP829-A**

Safety Tips

- Position on a flat, stable surface.
- A service agent/qualified technician should carry out installation and any repairs if required. Do not remove any components on this product.
- Consult Local and National Standards to comply with the following:
 - Health and Safety at Work Legislation
 - Fire Precautions
 - Wiring Regulations
 - Building Regulations
- **Warning! Hot surface!**
- This product is only designed to store food temporarily. Do not use for laboratory or industrial purposes.
- DO NOT use jet/pressure washers to clean the appliance.
- DO NOT use the appliance outside.
- DO NOT use the appliance to store medical supplies.
- DO NOT use electrical appliances inside the appliance (e.g. heaters, ice-cream makers, etc.).
- DO NOT allow oil or fat to come into contact with the plastic components or door seal. Clean immediately if contact occurs
- DO NOT store products on top of the appliance.
- Always carry, store and handle the appliance in a vertical position and move by holding the base of the appliance.
- Always switch off and disconnect the power supply to the unit before cleaning.
- Keep all packaging away from children. Dispose of the packaging in accordance to the regulations of local authorities.



- If the power cord is damaged, it must be replaced by an Apuro agent or a recommended qualified technician in order to avoid a hazard.
- This appliance is not intended for use by persons (including children) with reduced physical, sensory or mental capabilities, or lack of experience or knowledge, unless they have been given supervision or instruction concerning the use of the appliance by a person responsible for their safety.
- Children should be supervised to ensure that they do not play with the appliance.
- Apuro recommend that this appliance is PAT tested on an annual basis to ensure the product remains safe.

Introduction

Please take a few moments to carefully read through this manual. Correct maintenance and operation of this machine will provide the best possible performance from your Apuro product.

Pack Contents

The following is included:

- Apuro Heated Banquet Cabinet
- Left support bars (x16)
- Right support bars (x16)
- Rectangular water tray (with 2 hanging holes)
- Square water tray
- Instruction manual

Apuro prides itself on quality and service, ensuring that at the time of packaging the contents are supplied fully functional and free of damage.

Should you find any damage as a result of transit, please contact your Apuro dealer immediately.

Installation

1. Remove the appliance from the packaging. Make sure that all protective plastic film and coatings are thoroughly removed from all surfaces.
2. Maintain a distance of 20cm (7 inches) between the unit and walls or other objects for ventilation.



Note: Before using the appliance for the first time, clean the interior with soapy water.

3. Set the brakes on the castors to keep the appliance in position.

Fitting the pan supports and water trays

1. Place support bar on the ladder at the desired height, mounting the rear end of the support bar to the ladder first.

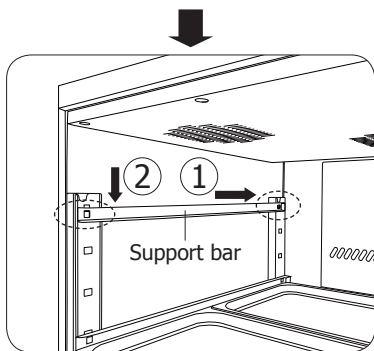
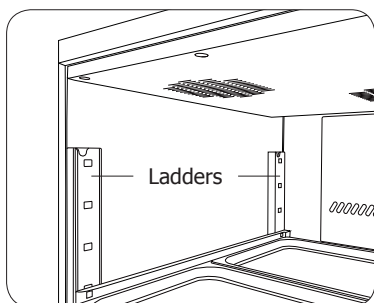

2. Repeat for the remaining support bars.
3. Slide the GN pans/shelves into place.
4. Fix the water trays as instructed below.

Square water tray

Directly push into the support brackets on the underside of the cabinet.

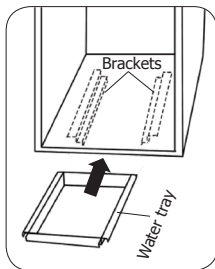

Rectangular water tray

Hang onto the pre-mounted bolts on the interior back wall, ensuring it is fixed in place.

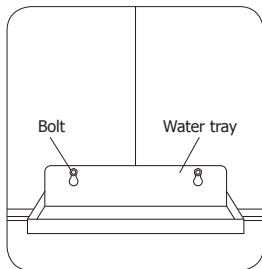

Operation

Control panel

<p>The control panel is located above the door on the front of the appliance.</p>	<p>75 Cabinet Temperature Display</p>
	<p> Fan On</p>
	<p> Down button</p>
	<p> On / Off button: Press and hold for 3 seconds to switch system on / off</p>
	<p> Up Button</p>

Turn On

1. Put the food in and close the door.
2. Connect the appliance to a mains power supply.
3. Press and hold for 3 seconds.

Adjusting the Temperature

1. Press for 1 second. The set temperature will flash.
2. Press the up button or down button to change the set temperature.
3. Wait 6 seconds for the set temperature to be stored.









Parameter Setting

The operating parameters of this appliance have been preset for optimum performance and to maximise the life of the appliance.

The default value of set temperature is 75°C.

Parameter	Function	Range	Default
PAS	Password	0 ~ 100	15
E1	Lower setpoint temperature	25°C ~ SET	70°C
E2	Upper setpoint temperature	SET ~ 85°C	82°C
E3	Temperature hysteresis	1°C ~ 10°C	4°C
E4	Time delay of starting machine	1 ~ 8 min.	3 min.
E5	Temperature probe adjustment	-5°C ~ +5°C	0°C

Should the parameter need adjusting:

1. Press  twice. The display will show "PAS".
2. Press  or  to input correct password (The default value is 15).
3. Press  to confirm. The system enters the parameter code selecting mode.
4. Press  to select the desired parameter code. The display will show the lower setpoint limit, the higher setpoint limit, the temperature hysteresis, time delay of starting the machine, and the Cabinet temperature probe adjustment consecutively.
5. Press  to confirm. The system enters the parameter value setting mode. Press  or  until the required value is displayed.
6. Press  again to confirm the selected parameter value. The system now exits the parameter value setting mode and returns to the previous parameter code selecting mode.



Note: If the password is correct, you can adjust parameters. Otherwise, you can only view parameters.

Cleaning, Care & Maintenance



Switch off and disconnect the appliance from the power supply. Allow to cool down before cleaning.

- Clean the interior of the appliance as often as possible.
- Do not use abrasive cleaning agents. These can leave harmful residues.
- Clean the door seal with warm soapy water.
- Always wipe dry after cleaning.

Cleaning the water trays

- Empty the tray on the interior back wall. Wipe dry with a kitchen towel if needed.
- Pull the other tray out of the brackets on the underside. Empty and Wipe dry.

Troubleshooting

Fault	Probable Cause	Solution
The unit is not working	The unit is not switched on	Check the unit is plugged in correctly and switched on
	Plug and lead are damaged	Call Apuro agent or qualified Technician
	Fuse in the plug has blown	Replace the plug fuse
	Power supply	Check power supply
	Internal wiring fault	Call Apuro agent or qualified technician
Poor heating effect	Poor ventilation	Increase ventilation
	Door is opened frequently or not shut properly	Check door is shut and seals are not damaged
	Food is too cold or too much food in the appliance	Remove excessive food
	Temperature improperly set	Re-set the temperature
Loud noises	The appliance has not been installed in a level or stable position	Check installation position and change if necessary
	Loose screw/nut	Check and tighten all nuts and screws
Odour from the unit	Unit is not cleaned for long time	Clean the unit thoroughly
	Odour foods are not properly packed	Seal and pack odour foods properly

Technical Specifications

Model	Voltage	Power	Current	Temperature range	Capacity	Dimensions h x w x d mm	Weight
CP829-A	220-240V 50Hz	1400W	6.5A	70°C ~ 82°C	345L	1770 x 781 x 872	110kg

Electrical Wiring

The plug is to be connected to a suitable mains socket.

This appliance is wired as follows:

- Live wire (coloured brown) to terminal marked L
- Neutral wire (coloured blue) to terminal marked N
- Earth wire (coloured green/yellow) to terminal marked E

This appliance must be earthed.



If in doubt consult a qualified electrician.

Electrical isolation points must be kept clear of any obstructions. In the event of any emergency disconnection being required they must be readily accessible.

Compliance

The product must not be disposed of as household waste. To help prevent possible harm to human health and/or the environment, the product must be disposed of in an approved and environmentally safe recycling process. For further information on how to dispose of this product correctly, contact the product supplier, or the local authority responsible for waste disposal in your area.

Apuro parts have undergone strict product testing in order to comply with regulatory standards and specifications set by international, independent, and federal authorities.

Apuro products have been approved to carry the following symbol:



All rights reserved. No part of these instructions may be produced or transmitted in any form or by any means, electronic, mechanical, photocopying, recording or otherwise, without the prior written permission of Apuro.

Every effort is made to ensure all details are correct at the time of going to press, however, Apuro reserve the right to change specifications without notice.

DECLARATION OF CONFORMITY

Equipment Type	Banquet Trolley
Model	CP829-A
Legislation	Electrical Safety Electromagnetic Compatibility
Standards	IEC 60335-1: 2010 (Fifth Edition) IEC 60335-2-49: 2002 (Fourth Edition) +A1: 2008 EN 610000-6-3: 2007 +A1:2011
Producer Name	Apuro
Producer Address	15 Badgally Road, Campbelltown, NSW 2560

I, the undersigned, hereby declare that the equipment specified above conforms to the above Legislation and Standard(s).

Date	22nd February 2019
Signature	
Full Name	Ashley Hooper
Position	Technical & Quality Manager/ Responsible Supplier

apuro

CP829-A_A5_v1_20190313