

Drop In Ice Well with Raised Flange

ICEDI-403530

(400mm x 350mm x 300mm)

- Internal skin - constructed from 1.2mm 304 grade stainless steel
- External skin - constructed from 1.2mm 304 grade stainless steel complete with a raised flange to prevent cross contamination
- Radius corners and cross breaks to a 25mm centre waste
- 25mm urethane injected insulation
- Ice lid and basket available (optional)
- Custom sizes available, custom made products incur a lead time

Top

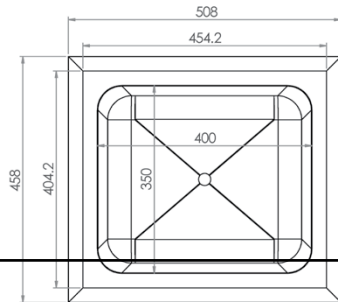

Side

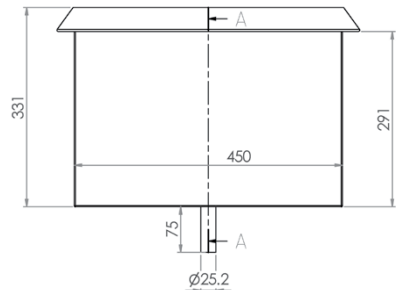

Cross Section

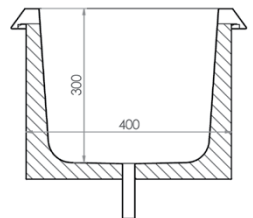

ICEL-403530
ICEB-403530

