



Sauna Heater 1116-450-1705, 1116-650-1705 or 1116-900-1705 with Controls 1601-11, 1601-11-1, 1601-14, 1601-14-1, 1601-15, or 1601-15-1

## Pikkutonttu 4.5, 6.5, & 9.0 kW with Digi Controls

Read all instructions carefully before installation.

Please leave all instructions with the owner.

### WARNING

*Prolonged exposure to elevated temperatures is capable of inducing hyperthermia. Hyperthermia occurs when the internal temperature of the body reaches several degrees above the normal body temperature of 98.6°F. The symptoms of hyperthermia include an increase in the normal temperature of the body, dizziness, lethargy, drowsiness, and fainting. The effects of the hyperthermia include failure to perceive heat, failure to recognize the need to exit the room, unawareness of impending hazard, fetal damage in pregnant women, physical inability to exit the room and unconsciousness.*

### WARNING

*The use of alcohol, drugs, or medication is capable of greatly increasing the risk of fatal hyperthermia.*

## SECTION 1: GENERAL INFORMATION

These heaters are UL Listed for permanent installations and electrical connections. Built with splash proof construction, the conducting parts are protected against water. All wiring must be performed in accordance with local codes. See **Table 1** for wiring and room size requirements.

### Warning

*Do not take a sauna if using alcohol, drugs or medications.*

*Pregnant women or persons with poor health should consult their physician before using any sauna.*

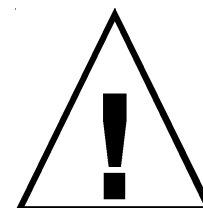
*Caution fire hazard: Do not use the sauna room for drying clothes, bathing suits, etc. Do not hang towels above heater or place any object, other than the rocks supplied, on the heater. If any darkening of the wall around the heater is noticed discontinue sauna use immediately.*

*Inspect sauna regularly for required maintenance to heater, control and benches. Replace wood surfaces which show any signs of deterioration.*

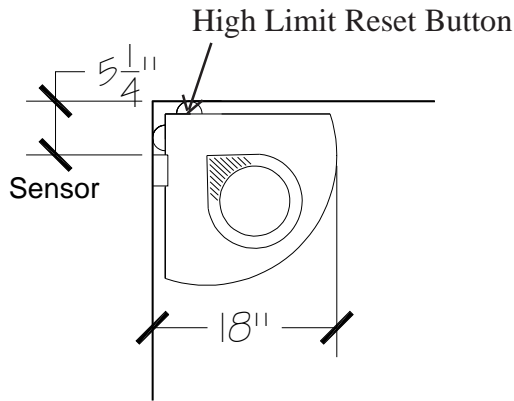
*The heater opening gets extremely hot during operation.*

*Keep clear of opening while sprinkling water on the rocks. Steam is very hot and forceful.*

*Minors should be adequately supervised whenever near a hot or warming sauna.*

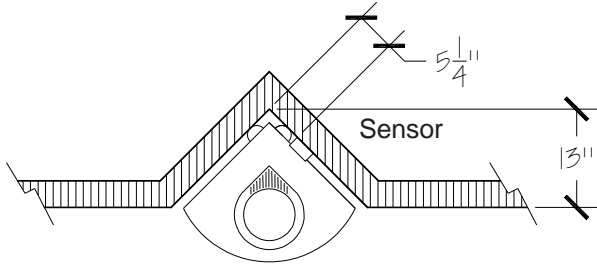


**DIAGRAM 1**



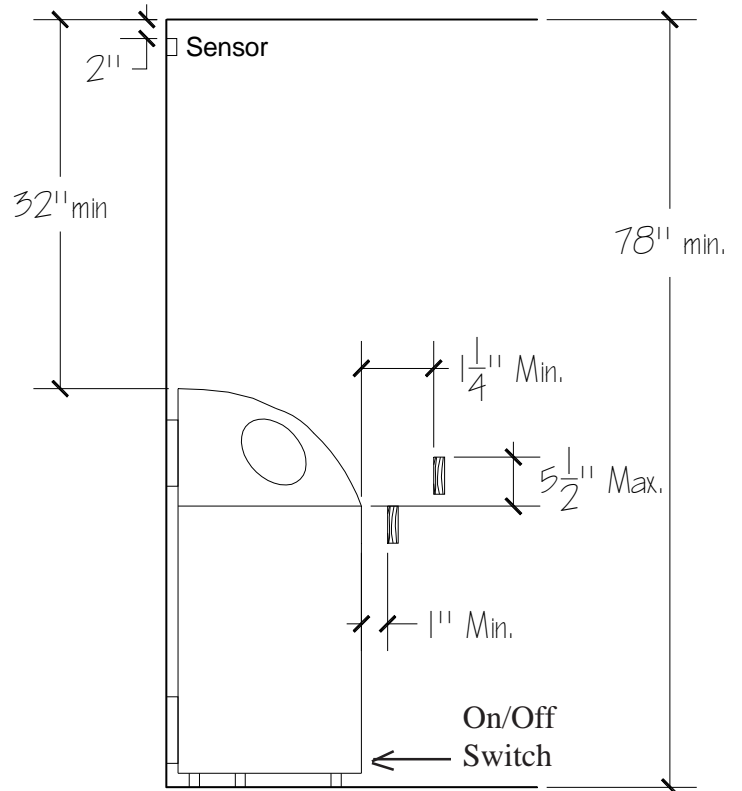
Sensor is mounted horizontally.

**DIAGRAM 2**



Example of an installation in depression of a wall.

**DIAGRAM 3**

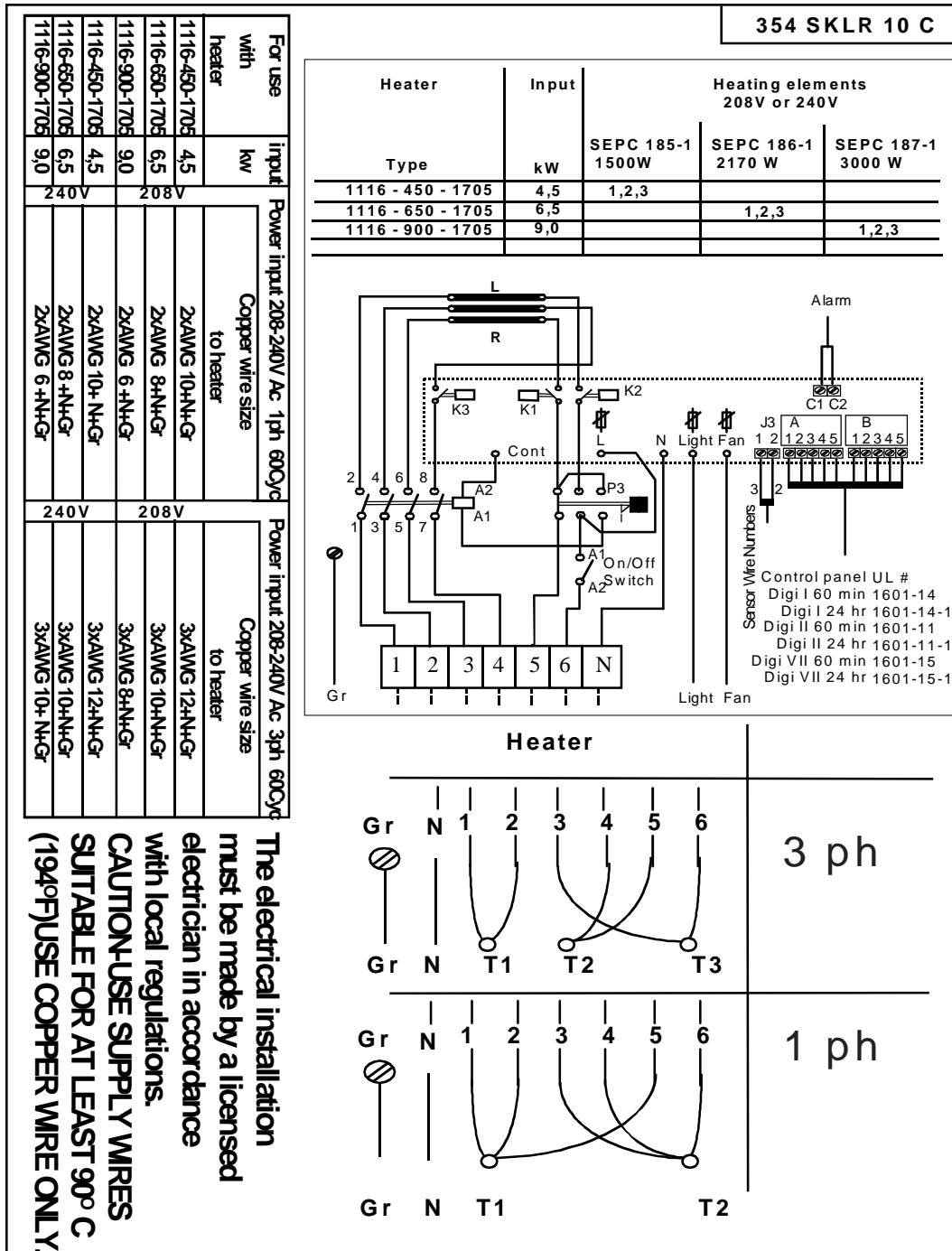


**! OBSERVING MINIMUM DISTANCES IS REQUIRED TO REDUCE THE RISK OF FIRE HAZARD**

**TABLE 1**

Model / UL #	kW	MINIMUM ROOM			MAXIMUM ROOM		PHASE	VAC	AMPS	WIRE SUPPLY TO
		Floor Area	Ceiling Height	Volume Cu. Ft.	Ceiling Height	Volume Cu. Ft.				
1116-450-1705	4.74	12 sq. ft.	78"	100	96"	210	1	208	22.8	2 #10 AWG + N+Gr
							1	240	19.8	2 #10 AWG + N+Gr
							3	208	13.1	3 #12 AWG + N+Gr
							3	240	11.4	3 #12 AWG + N+Gr
1116-650-1705	6.74	21 sq. ft.	78"	175	96"	350	1	208	32.4	2 #8 AWG + N+Gr
							1	240	28.1	2 #8 AWG + N+Gr
							3	208	18.7	3 #10 AWG + N+Gr
							3	240	16.2	3 #10 AWG + N+Gr
1116-900-1705	9.24	38 sq. ft.	78"	310	96"	500	1	208	44.4	2 #6 AWG + N+Gr
							1	240	38.5	2 #6 AWG + N+Gr
							3	208	25.6	3 #8 AWG + N+Gr
							3	240	22.2	3 #10 AWG + N+Gr

## DIAGRAM 4: WIRING DIAGRAM



### IMPORTANT WIRING INFORMATION:

A neutral wire is required to operate the control. The electrical installation must be made by a licensed electrician in accordance with local regulations.

Use 14-2 wire with ground for the fan and light. Maximum 120W light and fan circuits allowed.

**CAUTION-USE SUPPLY WIRES SUITABLE FOR AT LEAST 90 DC (194F) USE COPPER WIRE ONLY.**

## SECTION 2: MOUNTING SAUNA HEATER

Carefully locate the heater according to the dimensions shown in **Diagrams 1, 2, and 3.**

## SECTION 3: PLACING OF ROCKS

The rocks supplied with the heater have been chosen to provide the best heater performance. Use of any other type of rock may void the heater's warranty. Never operate the heater without rocks in place! Rinse the rocks with water before placing in the heater. Place the rocks loosely to keep the elements vertical and so the air can circulate through the heater. Packing the rocks too tightly may cause the heater high limit switch to trip. The rocks must fully cover the heating elements.

On a yearly basis, remove all rocks, clean rock fragments, and reinstall reusable rocks.

## SECTION 4: ELECTRICAL HOOK-UP

Electrical installation must be made by a licensed electrician in accordance with the National Electrical Code and local regulations.

To determine the correct wire size, refer to Table 1. Use copper supply wire only, suitable for minimum 90 degrees C. The heater must be grounded! See the heater wiring diagrams for proper connections.

Remove screws from the back cover to gain electrical access. Refer to **Diagram 7.**

## SECTION 5: GUARD RAIL

To reduce the risk of injury install the heater guard rail with the clearances and dimensions shown in **Diagram 3.**

## SECTION 6: OPERATION

The control for this heater has a thermostat to adjust the sauna temperature and a timer to control when the heater starts and stops. The maximum the timer will allow the heater to operate is 60 minutes. For health and fire safety, never attempt to alter or bypass the timer or thermostat. **The Digi XX 24 hr Control (UL # 1601-XX-1) models which can be set to stay on longer than 60 minutes is for commercial use only where an attendant is present.**

The Digi Controls shall be mounted outside the room. The control has 16ft of control wire supplied. The maximum control wire length would be 90ft. Additional wire may be special ordered.

The sensor shall be mounted over the heater refer to **Diagrams 1 thru 3.** Sensor wire is connected to terminals 1 and 2 on the circuit board. Refer to **Diagram 4.**

## Warning

*Fire sprinkler systems used inside any sauna room should be properly rated for sauna room temperatures.*

*Do not pour chlorinated pool or spa water on heater. Excessive water use on heater may cause damage and void warranty.*

*Do not install a shower in the sauna room.*

*Electric Shock Hazard - High voltage exists within this equipment. There are no user serviceable parts in this equipment. All installation and service to this equipment should be performed by qualified licensed personnel in accordance with local and national codes.*

*Do not construct sauna room so as to restrict air flow through the bottom of the heater.*

*Packing the rocks too tightly may cause the heater high limit switch to trip.*

## SECTION 6: OPERATION CONT.

### *Control Overview*

#### **Alarms**

The Digi II and VII controls are equipped with an alarm that indicates a faulty thermostat sensor and or thermostat wire. The control will display “T1 cable break”. During the alarm the control will turn power off to the heater and the control display will remain on. Rectify the fault situation by replacing the sensor or cable and press the On/Off button on control to clear alarm. If problem persists refer to **Section 14**.

**Digi VII** is also equipped with an alarm for high temperature. The alarm setpoint is determined in the Main Menu area of programming. If the control alarms for high temperature, follow the directions on the control to reset the alarm. The sauna should not be used again until the cause of the high temperature alarm has been determined and corrected.

*Optional Equipment:* There may be an audio and visual alarm connected to the contactor box to attract attention to the situation. The equipment should be mounted outside the sauna but within hearing range.

**Locking Key Pad** The control keypad can be locked. With the control in the Off mode, **press the up arrow key, then down arrow key and then fan key.** “Locked” will be displayed. This will make all keys inactive until the control is unlocked. To unlock the control repeat the same sequence.

## SECTION 6: DIGI II OPERATION

**Control Digi II  
60 min (UL #  
1601-11)**



**The Digi II 24 hr  
(UL # 1601-11-1)  
control model can be  
set to stay on longer  
than 60 minutes.  
This is for commer-  
cial use only where  
an attendant is  
present.**

On/Off  
Temperature  
Delayed Start Time  
Sauna Heat Time  
Light  
Fan

## SECTION 6: DIGI II OPERATION CONT.

### *Control Setup for Digi II 60 min Control (UL# 1601-11):*

This setup has **6 different menus**.

To escape from this **Setup Menu**, press the **On/Off** button or the device will **automatically exit** the menu in approx. **4 seconds**.

**To enter the Setup Menu** press **PROG/OK** button and hold down for approx. **3 seconds** until the following appears in the display:

**MENU 1**

**TIME: 12:00**

**Setting the Clock:** Press the up arrow and hold down: The minutes and hours will begin to change. When the hour reads the correct time, release the up arrow key and enter minutes by repeatedly pressing the arrow key for each minute. Press **PROG/OK** to save the time in memory.

Next will display:

**MENU 2**

**LANGUAGE: ENGLISH**

**Setting Language:** Press the up or down arrow key repeatedly until the language you desire appears in the display. Press **PROG/OK** to save the Language in memory.

Next will display:

**MENU 3**

**OFFSET: T1 0C**

Using the arrow keys, select the calibration value (0 +/-10C).

Example: After reading the temperature on the thermometer in the sauna, you may have noticed that the temperature reading on the sauna thermometer is lower than the display on the control. Set Offset T1 to +4C to get the displayed temperature to match the thermometer. (**This offset does not change the actual temperature, this is just for indication only.**) Press **PROG/OK**: to save the calibration value.

Next will display:

**MENU 4**

**SMARTSAUNA: OFF**

Using the arrow keys, select ON or OFF Press **PROG/OK**: to save the setting.

Note: SmartSauna records the temperature changes during a sauna, and based on this information, the control can determine the length of time needed to heat the sauna to reach a set value. **This function is only used in the time delay mode.**

## Warning

*Minimum clearance from heater to wooden surfaces (benches, side walls, heater fence etc.) is shown in Diagram 1,2, & 3.*

*Use only copper wire of the size and type indicated in the Heater Specification Chart and the temperature rating indicated on the heater junction box.*

*All heaters and controls must be grounded per NEC to prevent electrical shock in case of unit failure.*

*Electrical outlets or receptacles must not be installed in a sauna room.*

*A guardrail or fence is required around the heater to reduce the risk of burns from accidental contact.*



## SECTION 6: DIGI II OPERATION CONT.

Next will display:

**MENU 5**  
**CLOCK: 24 h**


Using the arrow keys, select a 12 or 24-hour clock. If a 12-hour clock is selected, AM or PM will appear in the display after the time. Press **PROG/OK**: to save the setting.

Next will display:

**MENU 6**  
**TEMPERATURE: C**


Using the arrow keys, select the desired temperature scale. (Celsius or Fahrenheit) Press **PROG/OK**: to save the setting.

### *Programming Memory (User buttons)*


Press **ON/OFF**  button and the greeting appears in the display and the backlight comes on. Next press **PROG/OK** and the following will appear in the display: The first number indicates start time, the length of sauna duration, and the last number is the desired temperature.

**5:30 PM 01:00 156F** The maximum operational time is 60 minutes for the heater.

**Note!** The start time reading in the display is not saved in the memory slots. Time delay is not a memory option.

Press the **Sauna Heat Time**  button and the hours and minutes (hh:mm) will appear in the display.

Sauna Heat Time: **01:00** The duration can now be set using the arrow keys. When the desired time has been selected, press **PROG/OK** to return to previous screen.

Press the **TEMPERATURE**  button and the temperature value will appear in the display current temperature setting: **156F** The temperature can now be set using the arrow keys. When the desired temperature has been selected, press **PROG/OK** and the display will return to the previous screen.

To save the values to memory, press the memory buttons 1. The display will now read:

**PROGRAM1**  
**01:00 156F**

Press **PROG/OK** once again to return the display to **5:30 PM 01:00 156F**

### *Programming Memory (User buttons) continued...*

To program another memory button go back to the beginning of Programming Memory (user buttons). Press **ON/OFF** to exit the programming mode.

**Review** When the device is in Off mode, you can review your programmed values by pressing the memory buttons.

## SECTION 6: DIGI II OPERATION CONT.

### *Daily Operations of Memory (User buttons):*

Press **ON/OFF** and the greeting appears in the display and the backlight comes on.

Press the appropriate button to start operation of the **Light** and **Fan** ; press again to shut off. The corresponding symbols will appear in the display.

Press **Memory Button 1 - 4**: The system will turn on and operate according to the button's preset time and temperature until program has expired. The control will then turn off.


### *Setting Time Delay without SaunaSmart:*

The control is in the Off mode:

Press **ON/OFF** and A greeting appears in the display and the backlight comes on.

Press **PROG/OK** and the following will appear in the display start time, sauna length, and temperature.


**5:30 PM**      **01:00** The maximum operational time is 60 minutes for the heater.  
**156F**


Press Time Delay  button and the hours and minutes (hh:mm) will appear in the display.

**START:**

**12:00 PM**

The start time can now be set using the arrow buttons. When the desired time has been selected, press **PROG/OK** and the display will return to the previous screen.

Press the **Sauna Heat Time**  button and the hours and minutes (hh:mm) will appear in the display.  
Sauna Length:      **01:00**      The duration can now be set using the arrow keys. When the desired time has been selected, press **PROG/OK** to return to previous screen.

Press the **TEMPERATURE**  button and the temperature value will appear in the display current temperature setting:      **156F**      The temperature can now be set using the arrow keys. When the desired temperature has been selected, press **PROG/OK** and the display will return to the previous screen.

Press **PROG/OK** and hold down for about 3 seconds until the following appears in the display:

**3:00 PM**

**5:30 PM**      **SAUNA**

**3:00 PM** is the current time and **5:30 PM** is the start time, when the sauna is automatically turned on.



## SECTION 6: DIGI I OPERATION

**Digi I 60 min Control**  
(UL # 1601-14)

The Digi I 24 hr (UL #1601-14-1) control model can be set to stay on longer than 60 minutes. This is for commercial use only where an attendant is present.




## SECTION 6: DIGI I OPERATION CONT.


### ***Control Setup for Digi I 60 min Control (UL # 1601-14):***


#### ***Setting Temperature Scale:***


The control in the Off mode:

Press **ON/OFF**  FAHR will appear. Press the Up button to toggle between Fahrenheit and Celsius. Press **OK** when the appropriate scale is displayed.

#### ***Setting Time Delay:***

Press **Time Delay**  button and the indicator light will flash when making changes. Press the up or down arrow to get the appropriate setting. When the desired time has been selected, press **OK**.

Press the **Sauna Heat Time**  button and the indicator light will flash when making changes. Press the up or down arrow to get the appropriate setting (60 minutes maximum). When the desired time has been selected, press **OK**.


Press the **TEMPERATURE**  button and the indicator light will flash when making changes. Press the up or down arrow to get the appropriate setting. When the desired temperature has been selected, press **OK**.


Press **OK** and hold down for **approximately 3 seconds** until time comes on and the “:” in the time starts to flash. The control is programmed to the above settings.

#### ***Starting Sauna Immediately:***

The control is in the Off mode:

Press **ON/OFF**  **00:00** will appear. (Number indicates minutes)

Press the **SAUNA HEAT TIME**  button and the indicator light will flash when making changes. Press the up or down arrow to get the appropriate setting (60 minutes maximum). When the desired time has been selected, press **OK**.

Press the **TEMPERATURE**  button and the indicator light will flash when making changes. Press the up or down arrow to get the appropriate setting. When the desired temperature has been selected, press **OK**.

Press **OK** and hold down for **approximately 3 seconds** until time comes on and the “:” in the time starts to flash. The control is programmed to the above settings.

**Note:** Control holds the previous sauna length and temperature setting.

### ***Control Setup for Digi I 24 hr Control (UL # 1601-14-1):***

Control type 1601-14-1 is for commercial applications with attendance on duty. This control allows the sauna to heat for a maximum of 23 hours. Refer to 1601-14 control operation for programming. Clock will mean hours and minutes.

## SECTION 6: DIGI VII OPERATION

### Digi VII 60 min Control (UL # 1601-15)

The Digi VII 24 hr (UL # 1601-15-1) control model can be set to stay on longer than 60 minutes. This is for commercial use only where an attendant is present.



### **Digi VII 60 min Control (UL # 1601-15) Setup:**

This setup has **7 different menus**.

To escape from this **Setup Menu**, press the **On/Off** button or the device will **automatically exit** the menu in approx. **4 seconds**.

**To enter the Setup Menu** press **PROG/OK** button and hold down for approx. **3 seconds** until the following appears in the display:

**MENU 1**  
**TIME: 12:00**

**Setting the Clock:** Press the up arrow and hold down: The minutes and hours will begin to change. Set clock to appropriate time. Press **PROG/OK** to save the time in memory.

Next will display:

**MENU 2**  
**DAY: MONDAY**

Using the arrow keys, select the correct day of the week. Press **PROG/OK**: to save the setting.

Next will display:

**MENU 3**  
**LANGUAGE: ENGLISH**

**Setting Language:** Press the up or down arrow key repeatedly until the language you desire appears in the display. Press **PROG/OK** to save the Language in memory.

## SECTION 6: DIGI VII OPERATION CONT.

Next will display:

**MENU 4**

**OFFSET: T1 0C**

Using the arrow keys, select the calibration value (0 +/-10C).

Example: After reading the temperature on the thermometer in the sauna, you may have noticed that the temperature reading on the sauna thermometer is lower than the display on the control. Set Offset T1 to +4C to get the displayed temperature to match the thermometer. (**This offset does not change the actual temperature, this is just for indication only.**) Press **PROG/OK**: to save the calibration value.

Next will display:

**MENU 5**

**CLOCK: 24 h**

Using the arrow keys, select a 12 or 24-hour clock. If a 12-hour clock is selected, AM or PM will appear in the display after the time. Press **PROG/OK**: to save the setting.

Next will display:

**MENU 6**

**TEMPERATURE: C**

Using the arrow keys, select the desired temperature scale. (Celsius or Fahrenheit) Press **PROG/OK**: to save the setting.

Next will display:

**MENU 7**

**ALARM: 100**

Using the arrow keys, select the desired alarm temperature setpoint. Press **PROG/OK**: to save the setting.

### ***Programming the Daily Programs:***

The control is in the Off mode:

Press **ON/OFF** and a greeting appears in the display, the backlight comes on, and the following will appear in the display **MON 5:30 PM** Current day of the week and time.


Press **PROG/OK** button and the display will show View Daily Program.

Next press **PROG/OK** and the following will appear in the display: The first number indicates start time, the length of sauna duration, and the last number is the desired temperature.

**5:30 PM MON 5:30 PM** is the start time and **MON** is the day


**01:00 156F 01:00** is the length of sauna and **156F** is the set temperature. The maximum operational time is 60 minutes or 23 hours depending on the control type.

### ***Changing Start Time***


To change the start time press the **Delayed Start Time**  button and the hours and minutes (hh:mm) will appear in the display. **Start Time: 1:00 PM** The start time can now be set using the arrow keys. When the desired time has been selected, press **PROG/OK** to return to previous screen. To bypass the day so no heat cycle is used, press the Delayed Start Time button again and the display will read **Start Time: - :- -.**

## SECTION 6: DIGI VII OPERATION CONT.

### *Changing Sauna Length of Operation*

To change the sauna length time press the **Sauna Heat Time**  button and the hours and minutes (hh:mm) will appear in the display. **On Time 1:00** The time can now be set using the arrow keys. When the desired time has been selected, press **PROG/OK** to return to previous screen.

### *Changing Sauna Temperature*

Press the **TEMPERATURE**  button and the temperature value will appear in the display current temperature setting: **156F** The temperature can now be set using the arrow keys. When the desired temperature has been selected, press **PROG/OK** and the display will return to the previous screen. If all the information is correct press **PROG/OK**.

### *Saving Each Day*

The display will read **Copy the data to the next day? No.** If the previous day's data should not be copied to the next day choose No. If the next day should be the same as the previous day, press the arrow keys to display Yes. When the desired answer has been selected, press **PROG/OK** to return to previous screen.

### *Repeating Program Weekly*

Repeat programing each day of the week the same way through Sunday. After Sunday has been approved the display will read **Program Repeat Weekly? No.** If the program should not repeat every week continuously, choose No. If the program should run every week, press the arrow keys to display Yes. When the desired setting has been selected, press **PROG/OK**.

### *Testing Alarm (optional equipment)*

The display will read **Test Alarm?** If the alarm equipment is not connected select No by pressing the arrow keys and press **PROG/OK**. If the equipment is connected and it needs to be tested, select Yes by pressing the arrow keys and press **PROG/OK**. The audio and visual alarm should activate if connected. Press **PROG/OK** to deactivate.

### *Activating the Program*

The control will display **Activate Program?** If the delay program should not be activated, choose No. Press **PROG/OK**, the display will read the current day and time. The control is now waiting to be activated to run by delay program or the user memory buttons.

If the delay program is ready to begin, press the arrow keys to select Yes. When the desired setting have been selected, press **PROG/OK**. The display will read current day and time on the first line and the next programmed day and time will alternately flash on the second line.

### *Daily Operations of Memory (User buttons):*

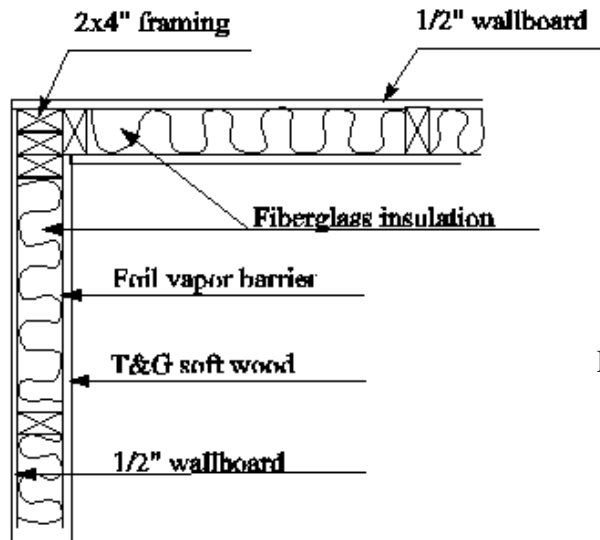
Press **ON/OFF** and the greeting appears in the display and the backlight comes on.

Press the appropriate button to start operation of the **Light** and **Fan** ; press again to shut off. The corresponding symbols will appear in the display.

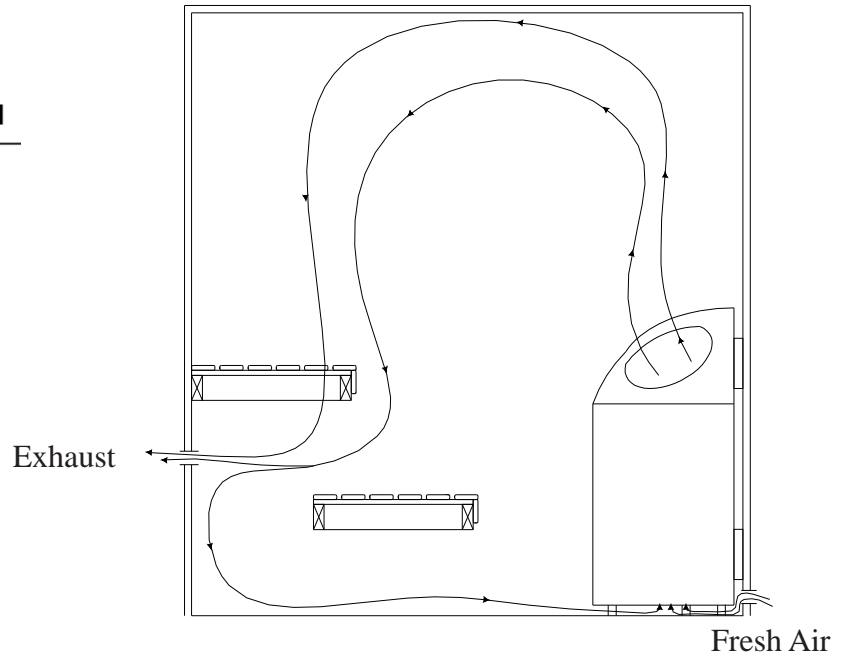
Press **Memory Button 1 - 4:** The system will turn on and operate according to the button's preset time and temperature until program has expired. The control will then turn off.

### DIAGRAM 5

#### TYPICAL PRE-CUT WALL CONSTRUCTION



### DIAGRAM 6



### DIAGRAM 7



Remove back square corner cover for electrical access of the heater.

Low voltage connections located under the heater. Ensure colors correspond to A1 of control to A1 of heater.



## SECTION 8 : WARNING PLACARDS

Two metal placards are included in the Installation Instruction Envelope packaged with the heater.

The CAUTION placard must be attached to the interior wall of the sauna room directly above the heater where it is visible to the bather.

The WARNING placard must be attached to the door of the sauna room.

## SECTION 9 : ROOM CONSTRUCTION

For safety and reliability, the following rules must be addressed.

- No permanent locking or latch system can be used on the sauna door.
- Acceptable door fittings are: magnetic catches, friction catches, spring or gravity loaded closures. The door must always open outwards.
- No shower can be installed in a sauna room.
- No electrical receptacle shall be installed inside the sauna room.
- The enclosed WARNING: Reduce the risk of overheating ...the warning plate must be mounted on or alongside the door outside the sauna room at about eye level.
- The enclosed CAUTION: Reduce the risk of fire ... the caution plate must be mounted on the interior wall above the heater.
- The heater must not be operated without its container properly filled with rocks and the rock guard in place.
- If an intercom speaker is installed, it should be away from the heater and as close to the floor as possible.
- If a room light is installed, it should be a surface mounted bracket type. Wall mounted lights should be about 70" above the floor. Ceiling mounted lights should be an approved type with a junction box that is remote to the fixture itself. Use only a fixture that uses A.F. or fixture type internal wiring. A 60 watt bulb should provide sufficient lighting.
- Fire sprinkler systems installed inside any sauna room should be properly rated for sauna room temperatures.
- Always mount the heater according to these installation instructions.
- Refer to **Diagram 5** for wall construction

### Warning

***The "CAUTION" and "WARNING" placards must be mounted in accordance with Section 8.***



#### REDUCE THE RISK OF OVERHEATING

- \* Exit immediately if uncomfortable, dizzy, or sleepy. Staying too long in a sauna is capable of causing overheating.
- \* Supervise children at all times.
- \* Check with a doctor before use if pregnant, in poor health, or under medical care.
- \* Breathing heated air in conjunction with consumption of alcohol, drugs, or medication is capable of causing unconsciousness.



#### REDUCE THE RISK OF FIRE

Do Not Place Combustible Material On The Heater At Any Time.

***For safety purpose sauna door must open out and not lock.***

***Never use a wood stain, seal or preservative on the inside of your sauna room.***

***Light fixtures get very hot during operation. Locate light fixture where it will not be a burn hazard.***

## SECTION 10 : HIGH LIMIT CONTROL (RESET BUTTON)

The sauna heater has a built-in High Limit control, which automatically turns off the heater if the temperature inside the sauna room rises to an abnormally high level.

To reset the high limit control, let the heater cool and then push the button. The reset button is on the back top right corner of the heater. The button is protected by a soft rubber grommet. Refer to **Diagram 1**.

If the High Limit continues to shut off the heater, contact a service representative.

## SECTION 11 : HOW TO TAKE A SAUNA

- When taking a sauna, allow time to relax completely.
- Remove clothing and jewelry.
- Some sauna bathers enjoy the soothing effect of steam by splashing water on the heated sauna rocks. Use only one dipper full (approx.  $\frac{1}{2}$  cup) at a time and take care to keep clear of the steam as it rises off the rocks.
- After 10 minutes or when perspiring freely, leave sauna and relax in the dressing area, followed with a warm shower.
- Enter sauna room again when ready and stay 5 or 10 minutes.
- Repeat the cycle 2 or 3 times; end with a warm shower and rinse in cool water.
- Dress when completely dry and perspiration has stopped.
- Do not smoke, exercise or drink alcoholic beverages in the sauna room.
- Do not pour chlorinated pool or spa water on the heater or corrosion damage may result.



Shower



Sauna (10-15 min)



Rest (10-15 min)



Relax with juice or water



Like it?

Do it again and feel great.

## SECTION 12 : VENTILATION

**VENTILATION** Ventilation shall be provided in a sauna, the air should be changed about 6 times an hour. This can be achieved by making a vent opening (fresh air inlet) in the sauna wall directly below the heater. The air outlet must be lower than the upper benches, as far as possible from the heater and about two feet higher than the fresh air inlet vent, refer to **Diagram 6**.

The minimum opening should be determined using one of the following formulas:

$$\begin{aligned} \text{For } R < 31, \quad V &\geq 9.4 \\ \text{For } R \geq 31, \quad V &\geq 0.3R \end{aligned}$$

where  $R$  = the floor area of the room in square feet and  
 $V$  = the minimum vent size in square inches

## SECTION 13 : MAINTENANCE

The sauna, like a bathroom, should be kept clean and odor free.

Towels or mats should always be used on benches and floor as perspiration otherwise penetrates the soft wood.

Air out the sauna often by keeping the door and vents open when the sauna is not in use. Saunas that are in daily use should be washed down at least once a week to keep them clean and the air fresh. Duckboard should be removed from the sauna, the sauna floor mopped and dried in a conventional manner, and the duckboard thoroughly scrubbed and dried before returning to the sauna room. The sauna heater should be wiped down occasionally with a damp cloth to remove lint and dust. The rocks should be removed once a year for cleaning and small or crumbled rocks replaced.

To clean and remove perspiration stains, use soap or detergent in warm water, best applied with a scrub brush. Badly soiled surfaces may require sanding. Sand paper wrapped around a wooden block works well.

Benches and supporting structure must be inspected annually for potential deterioration due to age, dry rot or abuse. Any boards with signs of deterioration should be replaced immediately to avoid possible injury.

## SECTION 14 : TROUBLESHOOTING

For troubleshooting or service questions call 1-888-780-4427 and ask to speak with service. Prior to calling please have the Model & Type # available. You may also e-mail us at [techsupport@saunatec.com](mailto:techsupport@saunatec.com)