

VALIDO PER  
PRODUZIONE

MATERIAL REV. 02

MODIFICATIONS: MODIFIED MARKED WITH:

⑩	⑪	⑫
⑦	⑧	⑨

MODIFICATIONS: MODIFIED MARKED WITH:

④	⑤	⑥
①	②	③

② NOTE  
LE VERSIONI 100V E 120V DIFFERISCONO DALLA 230V PER:  
- IL COLORE DEI CAVETTI DI TERRA (VERDE AL POSTO DEL GIALLOVERDE)  
- IL COLLEGAMENTO DELLA MESSA A TERRA DELLA SCHEDA (VEDI DETTAGLIO)

NOTES  
100V AND 120V VERSIONS DIFFER FROM THE 230V VERSION FOR:  
- EATH CABLE COLORS (GREEN INSTEAD OF YELLOWGREEN)  
- CONNECTION OF BOARD EARTH CABLE (SEE DETAIL)

COLLEGAMENTO INTERFACCIA  
INTERFACE LINK

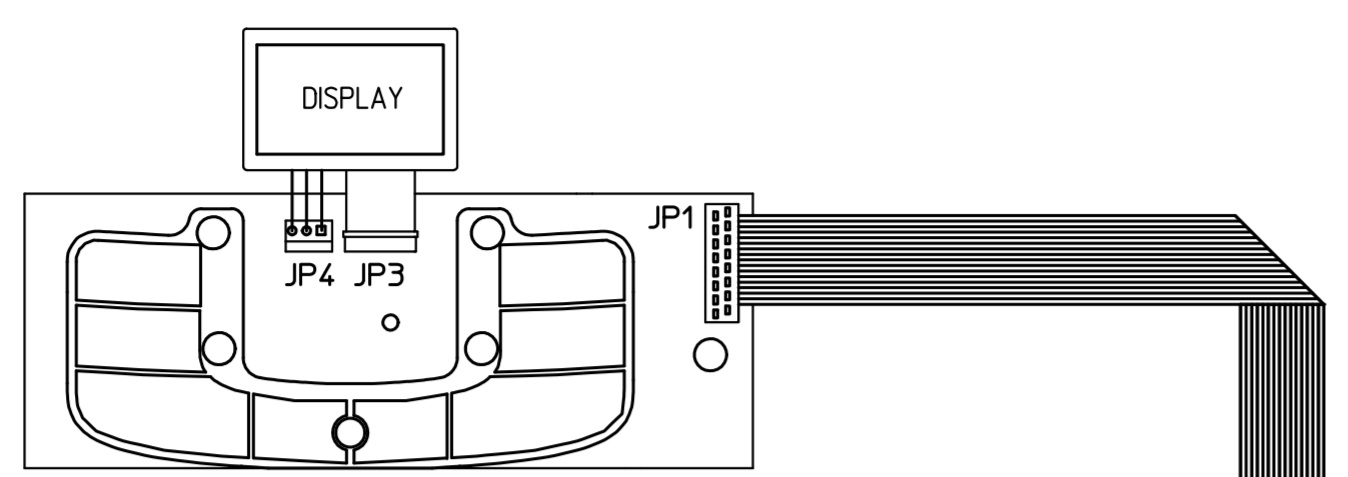

MOTORE GRUPPO EROGATORE  
BREW UNIT MOTOR

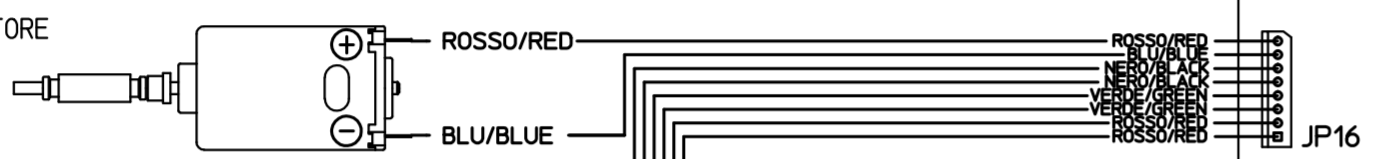

PRESENZA CASSETTO FONDI  
DREGDRAWER INSERTED



PRESENZA GRUPPO EROGATORE  
BREW UNIT INSERTED



GRUPPO EROGATORE WORK  
BREW UNIT POSITION WORK



SPORTELLO GRUPPO CHIUSO  
DOOR CLOSED

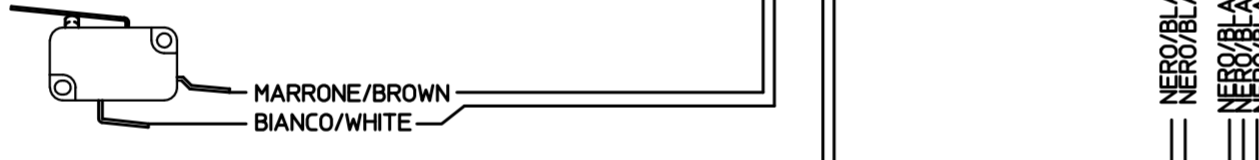

② SENSORE COPERCHIO CAFFÈ  
COFFEE BEANS DOOR SENSOR  
- SOLO PER VERSIONE 120V  
- ONLY FOR 120V VERSION

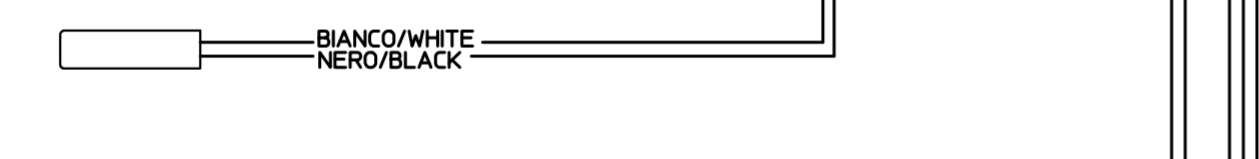

ELETTROVALVOLA VAPORE (2VIE)  
STEAM ELECTROVALVE (2 WAY)

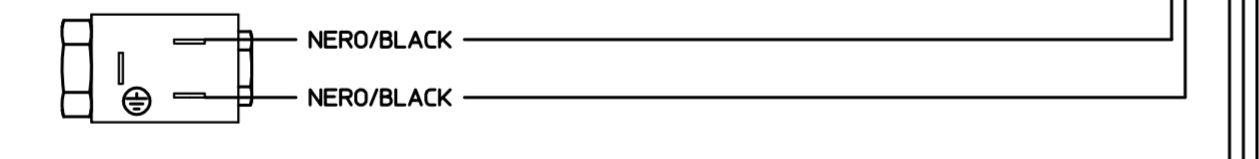

SENSORE LIVELLO CONTENITORE H2O  
WATERTANK SENSOR LEVEL



② SENSORE IMPULSI MACINACAFFÈ  
GRINDER ROTARY SENSOR  
- SOLO PER VERSIONE 120V  
- ONLY FOR 120V VERSION



SENSORE TEMPERATURA CAFFÈ  
TEMPERATURE SENSOR COFFEE



FLUSSIMETRO  
FLOWMETER

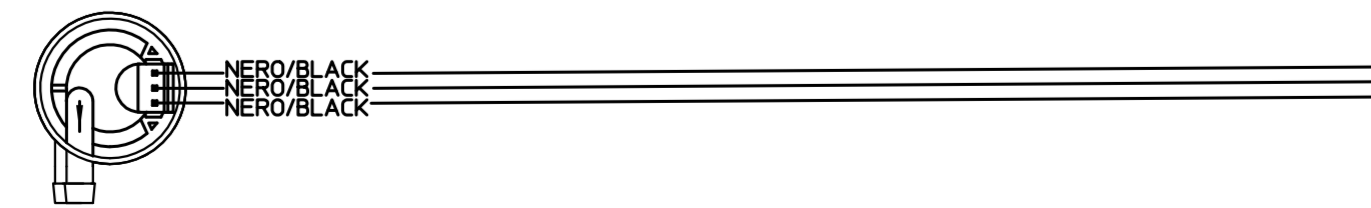

PROGRAMMATORE  
PROGRAMMER

PROG.

SCHEDA POWER/CPU  
POWER/CPU ELECTRONIC  
BOARD

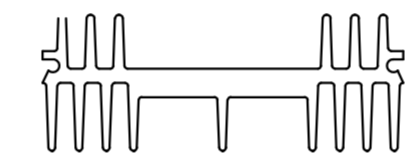

CONNETTORE IEC  
IEC CONNECTOR

CAVO ALIMENTAZIONE  
POWER CORD

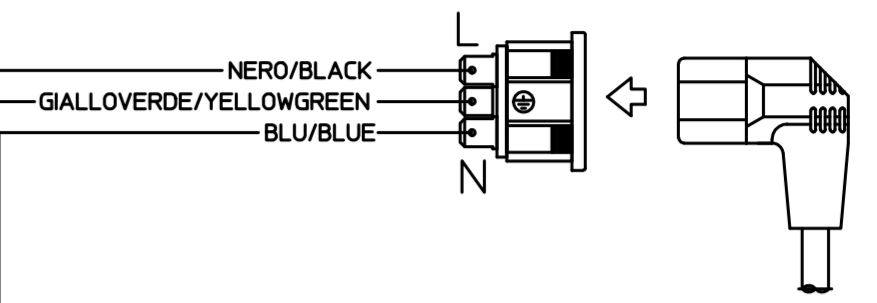

CALDAIA CAFFÈ  
COFFEE BOILER

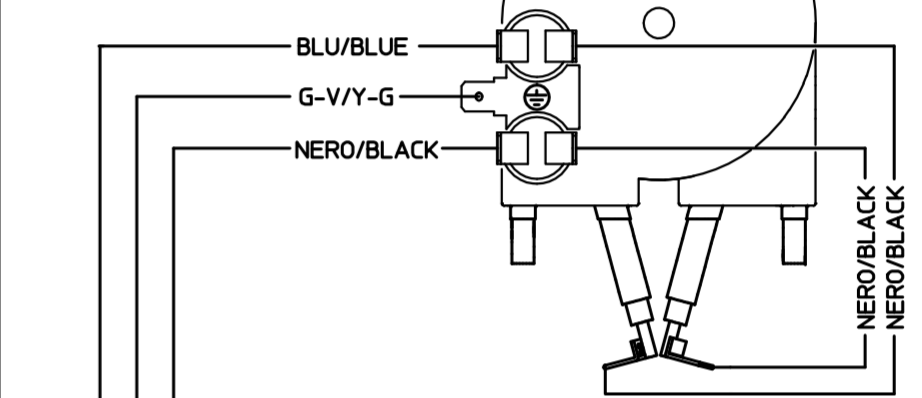

POMPA ACQUA  
WATER PUMP

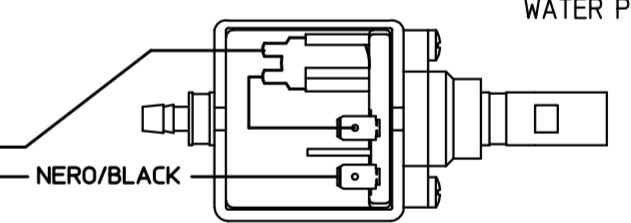

MOTORE MACINACAFFÈ  
GRINDER MOTOR

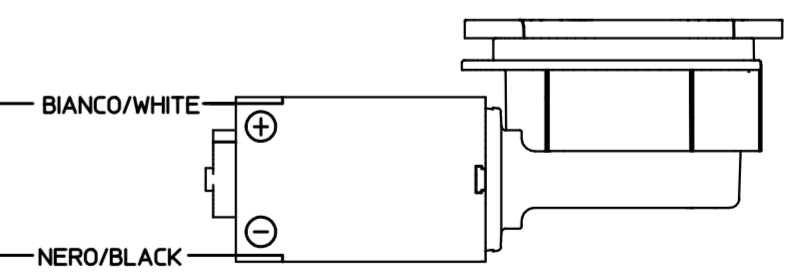

UTILIZZATA SULLA VECCHIA  
VERSIONE 230V  
USED ON OLD VERSION 230V

NON UTILIZZATA IN VERSIONE 120V  
NOT USED ON 120V VERSION

INDUTTANZA  
INDUCTANCE

① SCHEMA CABLAGGIO PER I MODELLI  
WIRING DIAGRAM FOR MODELS

HD8887	HD8888	HD8889
HD8900	HD8902	HD8904
HD8906	SUP047G	SUP047RG

PHILIPS Saeco.		DATE 02/07/2015	SCALE
MATERIAL		DRAWN BASSI F.	APPROVED PEPA G.
HEAT TREATMENT		GEN.TOLLERAN.	VOLUME (mm³)
SURFACE FINISH		MOULD CODE	N° CAVITY
MODEL SAECO INTELIA EV02 / GAGGIA VELASCA 120V / 220-240V		DRAWING REVISION 02	
DESCRIPTION SCHEMA CABLAGGIO HD8887 HD8900 WIRING LAYOUT HD8887 HD8900		DRAWING CODE / ITEM CODE 421946031881	