

Nash

Price List

Effective 11/1/2023

Order Information	56
Specifications	57
Shared Tables	59
Typicals	66



LIATfurniture.com
694 North Main Street · Troutman, NC 28166
TF 888 440 8205



Use this checklist to be sure you have all of the necessary information to place your order.

Catalog Number

Use our build guides to create your catalog number.

Laminate Selection ***Laminate tops only***

Standard Wilsonart or Formica. Please specify manufacturer, color, finish and model number.

PVC Edge Band ***PVC banded tops only***

See 8 for a complete list of standard LIAT PVC Edge Band options.

Metal Color Selection

See 10 for a complete list of standard LIAT Metal Color options.

Accessories

Tops

Table tops are constructed of 1-1/8" thick particle board core with a high pressure laminate on top and a backer sheet on the bottom. The edges are externally banded on all sides with a flush 3mm PVC band. Tables 60" in length and longer will receive a 14 gauge channeled stress bar for added support.

C-Base

The C-Bases are constructed of a 2-1/4" x 13 gauge steel column offset to one side of a cast aluminum foot in a powder coat finish. The column is welded to an 8" x 8" leg plate that attaches to the top with (8) #14 x 1" tapping PPH screws. Flip-tops, mobile legs and power options are available for select sizes.

T-Base

The T-Bases are constructed of a 2-1/4" x 13 gauge steel column centered on a cast aluminum foot in a powder coat finish. The column is welded to an 8" x 8" leg plate that attaches to the top with (8) #14 x 1" tapping PPH screws. Flip-tops, mobile legs and power options are available for select sizes.

X-Base

The X-Bases are constructed of a 2-1/4" x 13 gauge steel column centered on 2 cast aluminum feet in an "X" shape in a powder coat finish. The column is welded to an 12" x 12" leg plate that attaches to the top with (12) #14 x 1" tapping PPH screws. Flip-tops, mobile legs and power options are available for select sizes.

Y-Base

The Y-Bases are constructed of a 2-1/4" x 13 gauge steel column offset on 2 cast aluminum feet in a "Y" shape in a powder coat finish. The column is welded to an 8" x 8" leg plate that attaches to the top with (8) #14 x 1" tapping PPH screws. An extruded aluminum stretch spans the length between two bases. Flip-tops, mobile legs and power options are available for select sizes.

Disc Base

The Disc Bases are constructed of a 4" x 16 gauge steel column attached to a round steel plate at the base that attaches to the column with (2) flathead machine screws from the bottom side. The column is welded to a 12" x 12" plate that attaches to the top with (12) #14 x 1" tapping PPH screws.

Adjustable Leveling Glides

3/8-16 x 3/4" adjustable leveling glides come standard with all C-Base, T-Base, X-Base and Y-Base options.

Casters

Locking Casters are available on all C-Base, T-Base, X-Base and Y-Base options.

Spacers

Spacers (leveler extensions) are available to be paired with casters on all C-Base, T-Base and Y-Base options to allow the tables to be wheel barrowed.

Modesty Panel

A modesty panel can be added to any C-Base table. The modesty panel is available plain or perforated and is formed from steel sheet metal and powder coated. The folded panel bolts to the columns of the two bases, with 3/4" of space between the top and the panel to give 10" of modesty protection.

Flip-Top

The flip-top mechanism uses a rigid wedge-locking design to eliminate all movement in the mechanism. It features a unique injection molded housing, aluminum pivot and metal slider that interact together to offer the best in fit, form and function. The folding mechanism locks and releases using a single handle located towards the front of the table.

Electrical / Power

The standard built-in power upgrade option is an all metal flush clamp mounted power and charging solution with 2 power and 2 USB 2.1A charging ports and 108" cord length, constructed with 12A, 120 VAC spill resistant receptacles. Power units are available in Silver Pearl (-PS), Gloss White (-PW) and Black Powder Coat (-PB) finishes.

Daisy Link

The power units can be daisy linked together from a single power infeed. The units are non-sequential allowing the user to reconfigure the tables in any particular order. Each unit comes with (1) power unit, (1) female/female interconnecting cable, (1) female/male interconnecting cable and (4) plastic cable clamps and screws. Add the suffix "D" to the selected power option for this upgrade.

NOTE: *The starter cable is sold separately from the tables; see the accessories section for starter cable ordering information.*

Part Number
Configurator

NA – **ST** – **1** **2** **3** – **4** – **5**

Required Selections							
Component	Code	Description	24" Wide	30" Wide	36" Wide	42" Wide	
1 Width	24	24" Wide Boat Top Table	\$0	-	-	-	
	30	30" Wide Boat Top Table	-	\$0	-	-	
	36	36" Wide Boat Top Table	-	-	\$0	-	
	42	42" Wide Boat Top Table	-	-	-	\$0	
2 Length	60	60" Long Boat Top Table	\$1,274	\$1,309	\$1,316	\$1,491	
	72	72" Long Boat Top Table	\$1,313	\$1,339	\$1,363	\$1,554	
3 Top Shape	A	Boat Top	\$0	\$0	\$0	\$0	
4 Height	29	29" High Table	\$0	\$0	\$0	\$0	
	36	36" High Table	\$244	\$244	\$244	\$244	
	39	39" High Table	\$244	\$244	\$244	\$244	
	42	42" High Table	\$244	\$244	\$244	\$244	
	AS	Adjustable, Std Height (26"-35")	\$364	\$364	\$364	\$364	
	AB	Adjustable, Bar Height (29"-42")	\$446	\$446	\$446	\$446	
5 Base Style	TB	T-Base	\$0	\$0	\$0	\$0	
	YB	Y-Base	\$278	\$294	\$364	\$448	
Available Upgrades							
Component	Code	Description	60" Long	72" Long			
6 Flip-Top	-FT	Flip-Top w/ Handle	\$606	\$606			
7 Mobile Legs	-2CA	2 Casters/2 Spacers	\$162	\$162			
	-4CA	4 Casters	\$162	\$162			
8 Power	-PS	Cove - Silver Pearl	\$453	\$453			
	-PB	Cove - Black Powder Coat	\$453	\$453			
	-PW	Cove - Gloss White	\$453	\$453			
-2 Power / 2 USB charging unit included with 108" Cord							
9 Daisy Link	D	Daisy Link Power Units	\$202	\$202			
-Starter cable not included, see accessories for ordering information							

Quick Looks

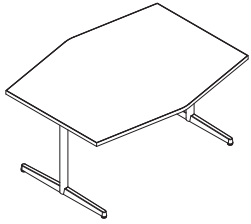

NA-ST-3660A-29-TB

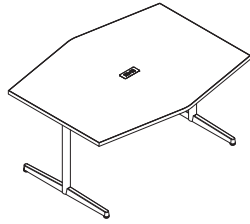

NA-ST-3660A-29-TB-PS

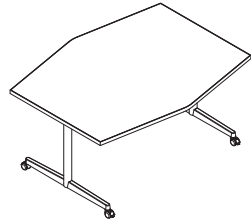

NA-ST-3660A-29-TB-4CA

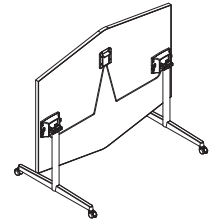

NA-ST-3660A-29-TB-FT-4CA

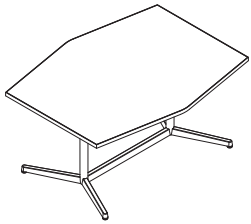

NA-ST-3660A-29-YB



NA-ST-3660A-29-YB-PS

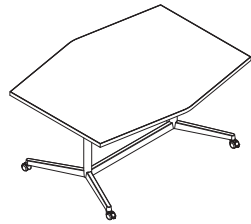

NA-ST-3660A-29-YB-4CA

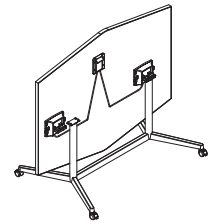

NA-ST-3660A-29-YB-FT-4CA

Base Styles

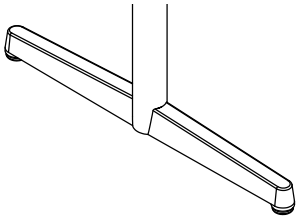

T-Base

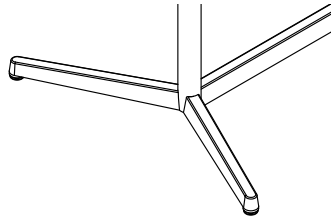

Y-Base

Popular Accessories

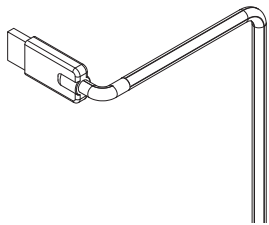

LA-DL1S-72

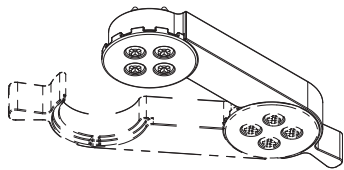

LA-TC900

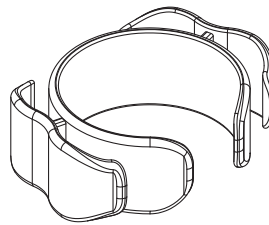

LA-WC01

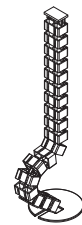

LA-WM16

Part Number
Configurator

NA – **ST** – **1** – **2** – **3** – **4** – **5**

Required Selections					
Component	Code	Description	21" Wide	24" Wide	30" Wide
1 Width	21	21" Wide Envelope Top Table	\$0	-	-
	24	24" Wide Envelope Top Table	-	\$0	-
	30	30" Wide Envelope Top Table	-	-	\$0
2 Length	60	60" Long Envelope Top Table	\$1,138	\$1,181	\$1,292
	72	72" Long Envelope Top Table	\$1,189	\$1,245	\$1,348
3 Top Shape	E	Envelope Top	\$0	\$0	\$0
4 Height	29	29" High Table	\$0	\$0	\$0
	36	36" High Table	\$244	\$244	\$244
	39	39" High Table	\$244	\$244	\$244
	42	42" High Table	\$244	\$244	\$244
	AS	Adjustable, Std Height (26"-35")	\$364	\$364	\$364
	AB	Adjustable, Bar Height (29"-42")	\$446	\$446	\$446
5 Base Style	CB	C-Base	\$0	\$0	\$0
	TB	T-Base	\$0	\$0	\$0
Available Upgrades					
Component	Code	Description	60" Long	72" Long	
6 Flip-Top	-FT	Flip-Top w/ Handle	\$606	\$606	
	-Not available for 30" wide C-Base units				
7 Modesty	-MPN	Modesty Panel, Plain	\$485	\$566	
	-MPP	Modesty Panel, Perforated	\$485	\$566	
-Modesty panels only available with a C-Base (CB)					
8 Mobile Legs	-2CA	2 Casters/2 Spacers	\$162	\$162	
	-4CA	4 Casters	\$162	\$162	
9 Power	-PS	Cove - Silver Pearl	\$453	\$453	
	-PB	Cove - Black Powder Coat	\$453	\$453	
	-PW	Cove - Gloss White	\$453	\$453	
-2 Power / 2 USB charging unit included with 108" Cord					
10 Daisy Link	D	Daisy Link Power Units	\$202	\$202	
-Starter cable not included, see accessories for ordering information					

Quick Looks

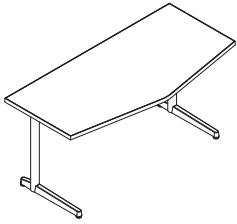

NA-ST-2460E-29-CB

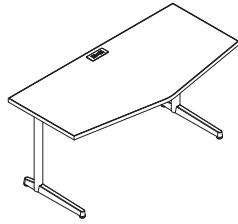

NA-ST-2460E-29-CB-PS

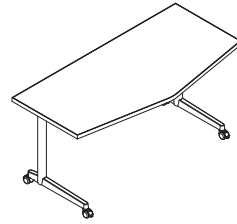

NA-ST-2460E-29-CB-4CA

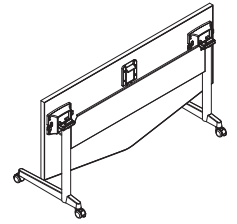

NA-ST-2460E-29-CB-FT-MPN-4CA

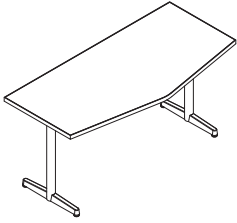

NA-ST-2460E-29-TB

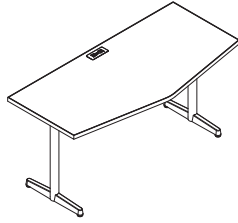

NA-ST-2460E-29-TB-PS

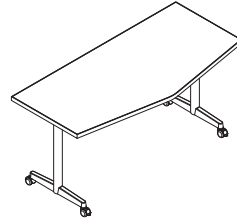

NA-ST-2460E-29-TB-4CA

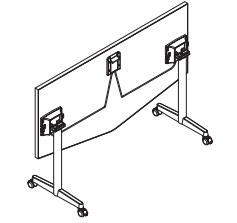

NA-ST-2460E-29-TB-FT-4CA

Base Styles

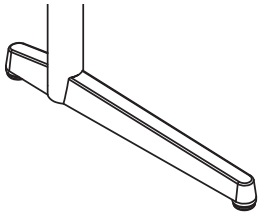

C-Base

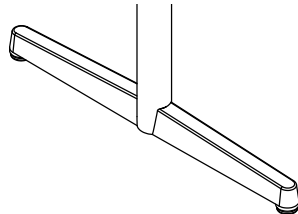

T-Base

Popular Accessories

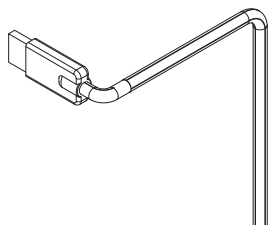

LA-DL1S-72

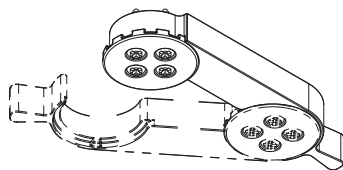

LA-TC900

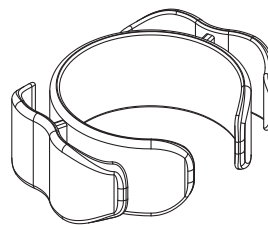

LA-WC01

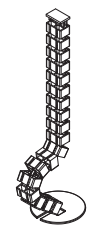

LA-WM16

Part Number
Configurator

NA – **ST** – **1** **2** **3** – **4** – **5**

Required Selections									
Component	Code	Description	21" Wide	24" Wide	30" Wide	36" Wide	42" Wide	48" Wide	
1 Width	21	21" Wide Table	\$0	-	-	-	-	-	-
	24	24" Wide Table	-	\$0	-	-	-	-	-
	30	30" Wide Table	-	-	\$0	-	-	-	-
	36	36" Wide Table	-	-	-	\$0	-	-	-
	42	42" Wide Table	-	-	-	-	\$0	-	-
	48	48" Wide Table	-	-	-	-	-	-	\$0
2 Length	48	48" Long Table	\$943	\$990	\$1,034	\$1,087	\$1,266	\$1,401	
	60	60" Long Table	\$1,032	\$1,096	\$1,131	\$1,290	\$1,444	\$1,575	
	72	72" Long Table	\$1,066	\$1,118	\$1,157	\$1,329	\$1,482	\$1,613	
3 Top Shape	R	Rectangle Top	\$0	\$0	\$0	\$0	\$0	\$0	
4 Height	29	29" High Table	\$0	\$0	\$0	\$0	\$0	\$0	
	36	36" High Table	\$244	\$244	\$244	\$244	\$244	\$244	
	39	39" High Table	\$244	\$244	\$244	\$244	\$244	\$244	
	42	42" High Table	\$244	\$244	\$244	\$244	\$244	\$244	
	AS	Adj, Std Height	\$364	\$364	\$364	\$364	\$364	\$364	\$364
	AB	Adj, Bar Height	\$446	\$446	\$446	\$446	\$446	\$446	\$446
5 Base Style	CB	C-Base	\$0	\$0	\$0	-	-	-	
	TB	T-Base	\$0	\$0	\$0	\$0	\$0	\$0	
	YB	Y-Base	-	-	\$294	\$364	\$448	\$556	
-Y Base only available on units 60" and longer									
Available Upgrades									
Component	Code	Description	48" Long	60" Long	72" Long				
6 Flip-Top	-FT	Flip-Top w/ Handle	\$606	\$606	\$606				
	-Not available for 48" wide units								
7 Modesty	-MPN	Modesty Panel, Plain	\$445	\$485	\$566				
	-MPP	Modesty Panel, Perforated	\$445	\$485	\$566				
-Modesty panels only available with a C-Base (CB)									
8 Mobile Legs	-2CA	2 Casters/2 Spacers	\$162	\$162	\$162				
	-4CA	4 Casters	\$162	\$162	\$162				
9 Power	-PS	Cove - Silver Pearl	\$453	\$453	\$453				
	-PB	Cove - Black Powder Coat	\$453	\$453	\$453				
	-PW	Cove - Gloss White	\$453	\$453	\$453				
-2 Power / 2 USB charging unit included with 108" Cord									
10 Daisy Link	D	Daisy Link Power Units	\$202	\$202	\$202				
-Starter cable not included, see accessories for ordering information									

Quick Looks

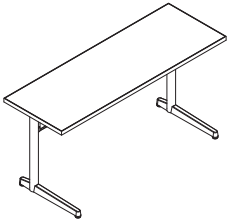

NA-ST-2160R-29-CB-MPN

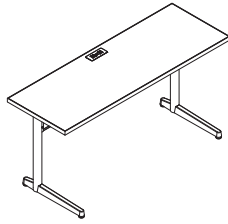

NA-ST-2160R-29-CB-MPN-PS

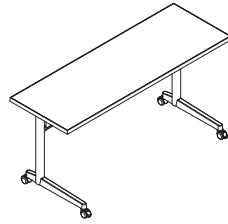

NA-ST-2160R-29-CB-MPN-4CA

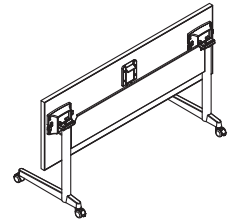

NA-ST-2160R-29-CB-FT-MPN-4CA

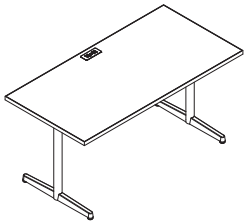

NA-ST-3060R-29-TB-PS

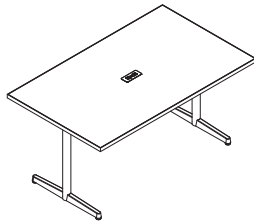

NA-ST-3660R-29-TB-PS

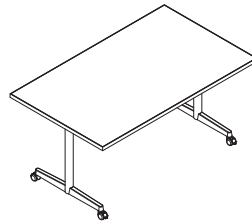

NA-ST-3660R-29-TB-4CA

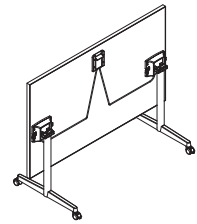

NA-ST-3660R-29-TB-FT-4CA

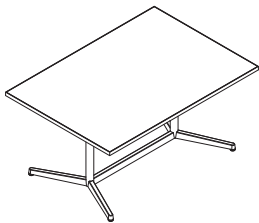

NA-ST-4260R-29-YB



NA-ST-4260R-29-YB-PS

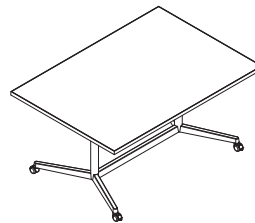

NA-ST-4260R-29-YB-4CA

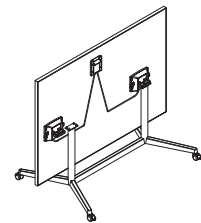

NA-ST-4260R-29-YB-FT-4CA

Power Locations

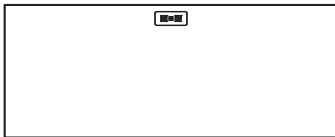

Less than 36" Wide

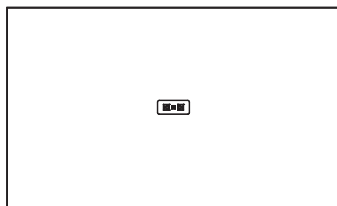

36" Wide and Over

Base Styles

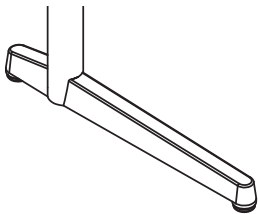

C-Base

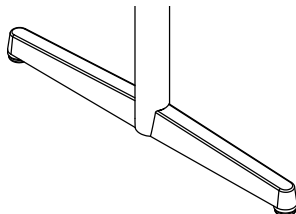

T-Base

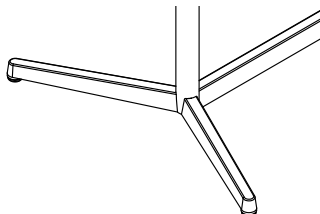

Y-Base

Popular Accessories

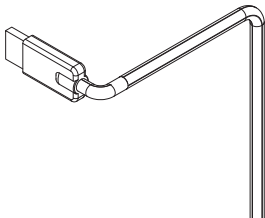

LA-DL1S-72

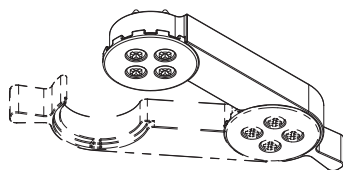

LA-TC900

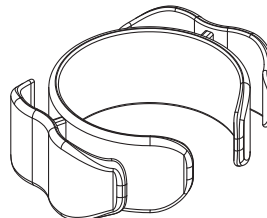

LA-WC01

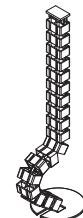

LA-WM16

Part Number
Configurator

NA – **ST** – **1** – **2** – **3** – **4** – **5**

Required Selections

Component	Code	Description	24"	30"	36"	42"
1 Size	24	24" Table	\$0	-	-	-
	30	30" Table	-	\$0	-	-
	36	36" Table	-	-	\$0	-
	42	42" Table	-	-	-	\$0
2 Top Shape	D	Round Top	\$875	\$921	\$976	\$1,129
	S	Square Top	\$807	\$854	\$908	\$1,062
3 Height	29	29" High Table	\$0	\$0	\$0	\$0
	36	36" High Table	\$122	\$122	\$122	\$122
	39	39" High Table	\$122	\$122	\$122	\$122
	42	42" High Table	\$122	\$122	\$122	\$122
	AS	Adjustable, Std Height (26"-35")	\$273	\$273	\$273	\$364
	AB	Adjustable, Bar Height (29"-42")	\$335	\$335	\$335	\$446
4 Base Style	DB	Disc Base <small>-Disc Base not available with adjustable height</small>	\$480	\$480	\$480	\$480
	XB	X-Base	\$0	\$0	\$0	\$0

Available Upgrades

Component	Code	Description	24"	30"	36"	42"
5 Flip-Top	-FT	Flip-Top w/ Handle	\$606	\$606	\$606	\$606
		<small>-Not available for Disc Base units</small>				
6 Mobile Legs	-4CA	4 Casters	\$162	\$162	\$162	\$162
		<small>-Not available for Disc Base units</small>				

Quick Looks



NA-ST-36D-29-XB

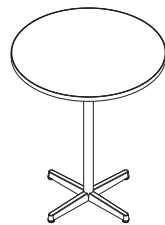

NA-ST-36D-42-XB

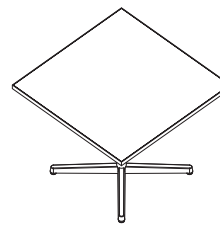

NA-ST-36S-29-XB

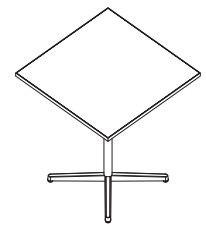

NA-ST-36S-42-XB

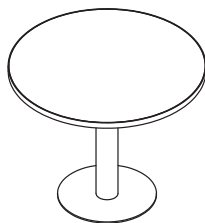

NA-ST-36D-29-DB

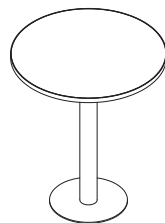

NA-ST-36D-42-DB

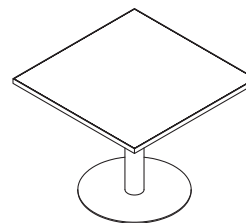

NA-ST-36S-29-DB

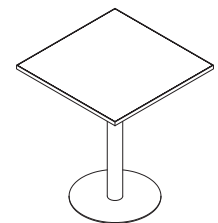

NA-ST-36S-42-DB

NA-001

Total List \$6,056

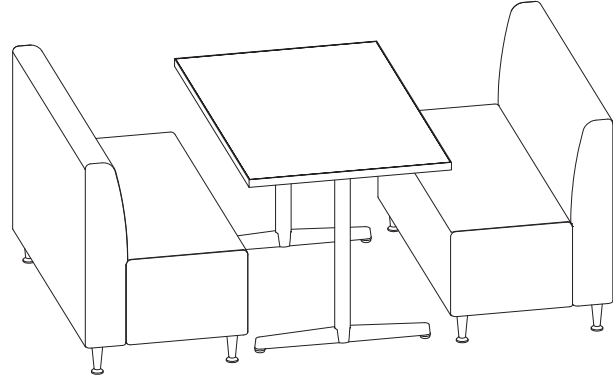
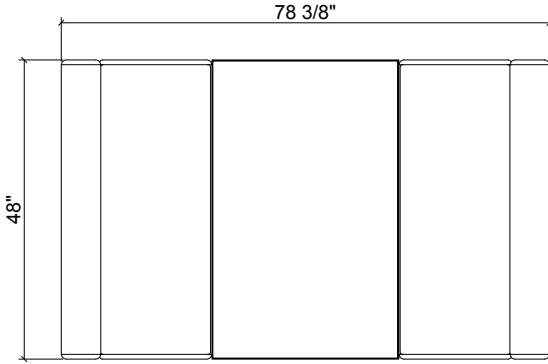

Model Number	Qty	List	Extension
TA-LG-2448S-UB-ML-G1	2	\$2,511	\$5,022
NA-ST-3048R-29-TB	1	\$1,034	\$1,034

NA-002

Total List \$7,565

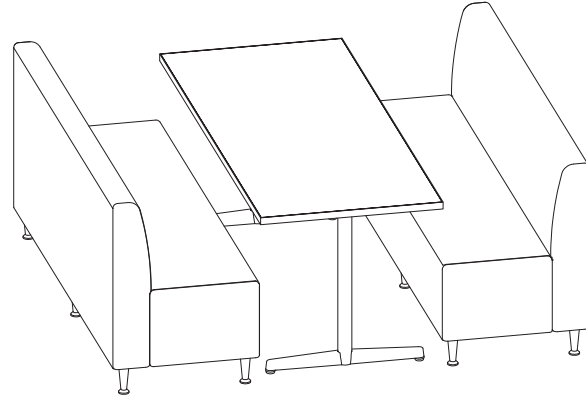
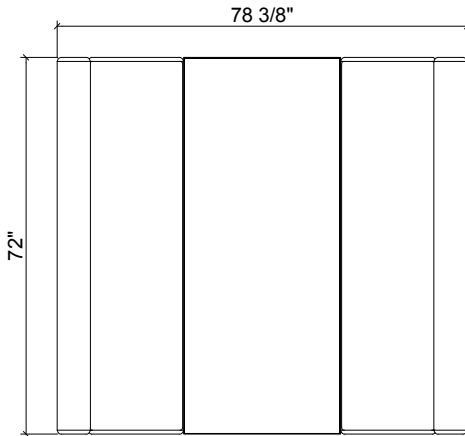

Model Number	Qty	List	Extension
TA-LG-2472S-UB-ML-G1	2	\$3,204	\$6,408
NA-ST-3072R-29-TB	1	\$1,157	\$1,157

NA-003

Total List \$11,779

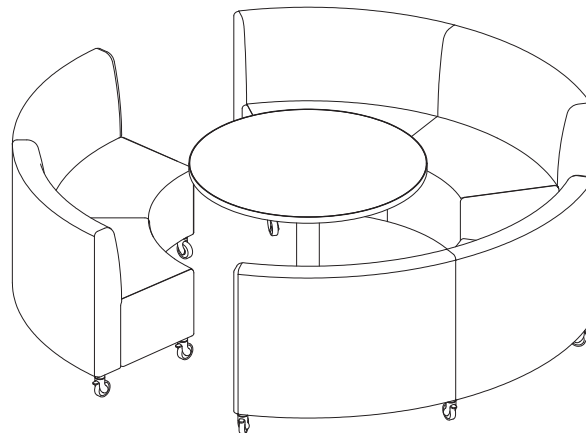
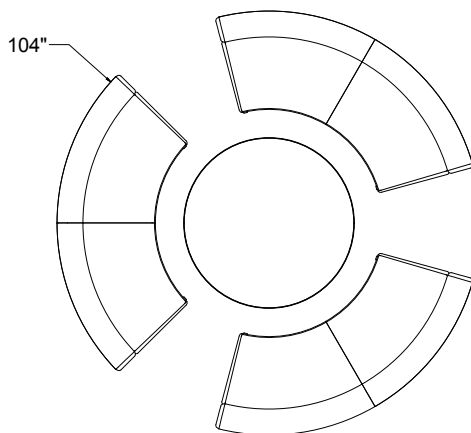

Model Number	Qty	List	Extension
TA-LG-2490IC-UB-CA-G1	3	\$3,390	\$10,170
NA-ST-42D-29-DB	1	\$1,609	\$1,609