

VELLA 5" DEEP ANTI-GLARE DOWNLIGHT

VM090-VF94SF01

By VONN Lighting

VONN

PROJECT:

TYPE:

CATALOG#:

DATE:

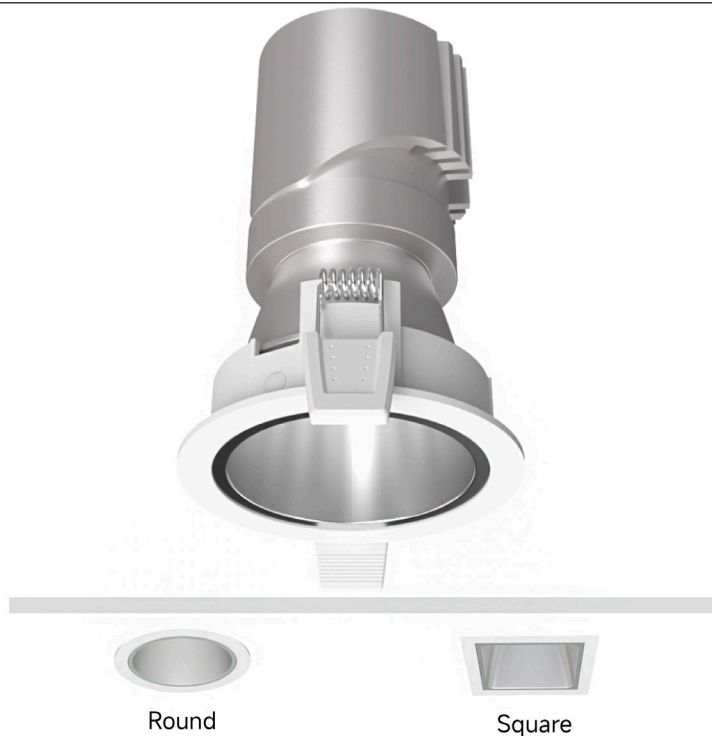

DESCRIPTION

The VELLA 5" Deep Anti-Glare Series, features a deep recessed mounting ring that enables a 48° cut-off for excellent glare control. The luminaires blend seamlessly into the ceiling layout, embodying the philosophy of "light instead of luminaires." With a highly modular design available in both round and square options, a honeycomb filter can also be added to maximize visual comfort.

FEATURES

- Elegant and compact in style, yet versatile in use.
- Precise light control, UGR <9.
- Super modular design, replacable LED module, mounting ring, beam lens and anti-glare accessories without any needs for tools.

SPECIFICATION

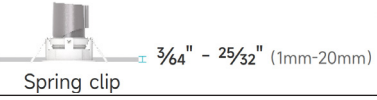
	VM090		
WATTAGE	25 W	30 W	35 W
LUMEN OUTPUT	2310 LM	2687 LM	3218 LM
BEAM OPTICS	Narrow Spot: 15°, Spot: 24°, Flood: 38°, Wide Flood: 55°		
COLOR TEMP.	Static White: 2700K, 3000K, 3500K, 4000K Dim to Warm: 2000K - 3000K		
COLOR QUALITY	80+/90+, 3-step SDCM		
INPUT WATTAGE	25 W	30 W	35 W
INPUT VOLTAGE	120/277V input, 50/60Hz		
POWER FACTOR	Greater than 0.9		
DIMMING TYPE	Triac dimming & 0-10V dimming range: 1%-100%		
CEILING THICKNESS	 Spring clip 3/64" - 25/32" (1mm-20mm)		
INSTALLATION	New Constructicon, Remodel, IC Rated Housing		
LISTINGS	ETL Listed to US and Canadian standards for damp locations. (IC) ETL listed for direct contact w/insulation.		
WARRANTY	5 year limited warranty		
AMBIENT OPERATING TEMPERATURE	-20°C to 40°C		
SYSTEM RATING	80% of initial lumens at 50000 hours (L80)		

Theoretical Lumens: XXX LM (subject to change)

Theoretical Wattage: XXX W (subject to change)

***Please note lumens and wattage are subject to change and will be determined post production of the first articles.

*Any custom modifications are subject to minimum order quantity. (M.O.Q.)

© VONN Lighting, 2025

VELLA 5" DEEP ANTI-GLARE DOWNLIGHT

VM090-VF94SF01

By VONN Lighting



PROJECT:

TYPE:

CATALOG#:

DATE:

ORDERING INFORMATION

VM090	VF	9	4	-	-	-	-	-	-	-	-
Led Module	Trim	Dimensions of trim	Application	Trim Shape	Trim Style	Flangeless Trim	Safety Standard	Voltage	Lumen Output	Dimming Methods	Including Housing
VM090	VF	9 Nominal size: 90mm	4 Deep anti-glare	RF Round fixed	01 Standard	F Flangeless Trim	A American standard	277 120-277V	L08 800lm	V 0-10V	C New Construction
				SF Square fixed				120 100-120V	L12 1200lm	T Triac	R Remodel
										X 0-10V/Triac	H Housing

ACCESSORIES (TO BE ORDERED SEPARATELY)

FOR INSTALLATION CONSULT THE INSTRUCTION SHEET

OPTICAL ACCESSORY

HONEYCOMB FILTER

VM090-H



SOFT LENS

VM090-L



LUMEN MULTIPLIERS

CCT	MULTIPLIER
2700K	0.95
3000K	1.00
3500K	1.03
4000K	1.05

CRI	MULTIPLIER
80+	1.23
90+	1.00

STANDARD TRIM	MULTIPLIER
VF94RF01 (Round fixed)	0.97
VF94SF01 (Square fixed)	1.00

Applying Lumen Multipliers to Calculate Delivered Lumens

Base Fixture Delivered Lumens (from PHOTOMETRIC DATA)	x	CCT Multiplier	x	CRI Multiplier	x	TRIM Multiplier	=	Delivered Lumens for Desired Fixture
STANDARD TRIM Example: VM090-VF94RF01 3500K 80+								
2265.4 lm	x	1.03	x	1.23	x	0.97	=	2783.4 lm

Theoretical Lumens: XXX LM (subject to change)

Theoretical Wattage: XXX W (subject to change)

***Please note lumens and wattage are subject to change and will be determined post production of the first articles.

*Any custom modifications are subject to minimum order quantity. (M.O.Q.)

© VONN Lighting, 2025

VONN, LLC.

3323 NE 163rd St. PH-706
North Miami Beach, FL 33160

WWW.VONN.COM 888.604.8666

VONN, LLC. reserves the right to make any design changes for continuous improvement which will not affect the overall appearance or performance.

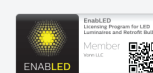

VELLA 5" DEEP ANTI-GLARE DOWNLIGHT



VM090-VF94SF01

By VONN Lighting

PROJECT:

TYPE:

CATALOG#:

DATE:

PHOTOMETRIC DATA (NON-DIMMING)

CCT (K)	CRI	LOAD (W)	BEAM OPTIC	LUMENS (lm)	EFFICACY (lm/w)	MAX CANDELA (cd)
3000K	90	25W	15°	2265	99	14893
			24°	2310	100	9778
			38°	2272	99	4768
			55°	2153	94	2923
		30W	15°	2687	97	17380
			24°	2668	97	11211
			38°	2666	97	5627
			55°	2522	92	3464
		35W	15°	3177	93	20842
			24°	3218	94	13601
			38°	3175	94	6660
			55°	3000	88	4079

Above test data is based on **Square Fixed** trim with 3000K 90CRI LED.

VM090-VF94SF01 25W

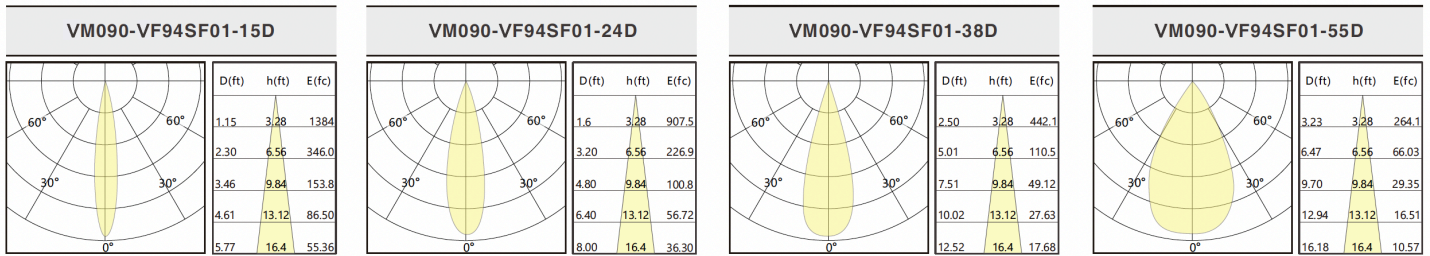

VM090-VF94SF01 30W

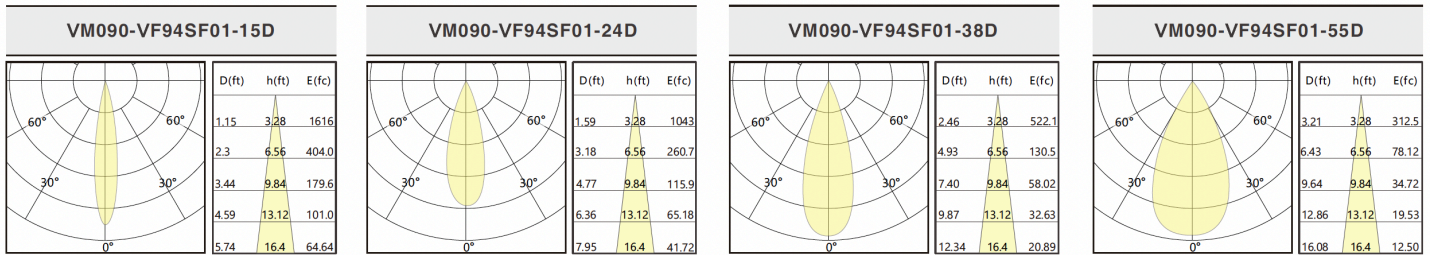

VM090-VF94SF01 35W

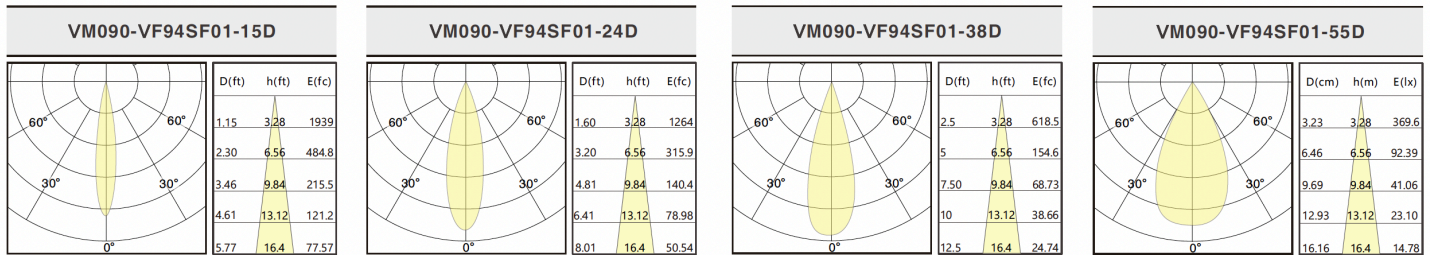

Above test data is based on **Square Fixed** trim with 3000K 90CRI LED.

Theoretical Lumens: XXX LM (subject to change)

Theoretical Wattage: XXX W (subject to change)

***Please note lumens and wattage are subject to change and will be determined post production of the first articles.

*Any custom modifications are subject to minimum order quantity. (M.O.Q.)

© VONN Lighting, 2025

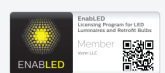

VELLA 5" DEEP ANTI-GLARE DOWNLIGHT



VM090-VF94SF01

By VONN Lighting

PROJECT:

TYPE:

CATALOG#:

DATE:

DIMENSION

LED Module



VM090

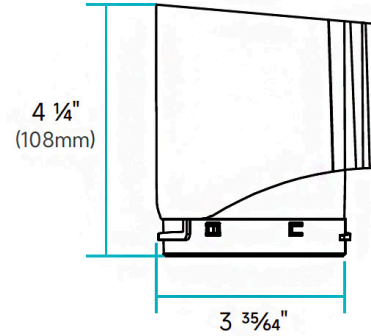

Trim for Anti-Glare Series



Round

VF94RF01

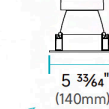

5 3/4" (140mm)

4 5/8" (125mm)

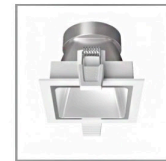

Square

VF94SF01

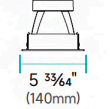

5 3/4" (140mm)

4 5/8" * 4 5/8" (125x125mm)

Theoretical Lumens: XXX LM (subject to change)

Theoretical Wattage: XXX W (subject to change)

***Please note lumens and wattage are subject to change and will be determined post production of the first articles.

*Any custom modifications are subject to minimum order quantity. (M.O.Q.)

© VONN Lighting, 2025

VONN, LLC.

3323 NE 163rd St. PH-706
North Miami Beach, FL 33160

WWW.VONN.COM 888.604.8666

VONN, LLC. reserves the right to make any design changes for continuous improvement which will not affect the overall appearance or performance.

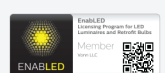

VELLA 5" DEEP ANTI-GLARE DOWNLIGHT

VM090-VF94SF01

By VONN Lighting



PROJECT:

TYPE:

CATALOG#:

DATE:

INSTALLATION

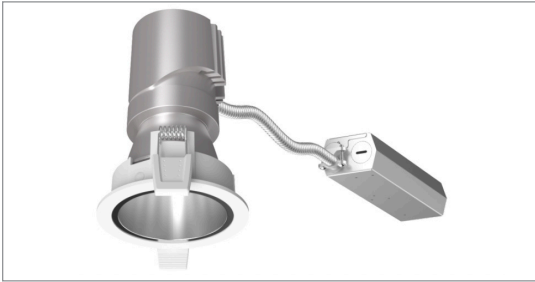

REMODEL

INSTALLATION

1. Direct connection with installed housing.
2. Operation temperature: -20°C - 40°C

DIMENSIONS FOR REMODEL MOUNTED DRIVER

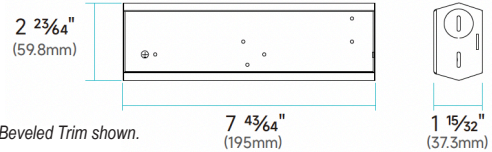

Note: Total height varies depending on trim, Beveled Trim shown.

Minimum height: 7 57/64" (200.5mm)

Maximum height: 7 57/64" (200.5mm)

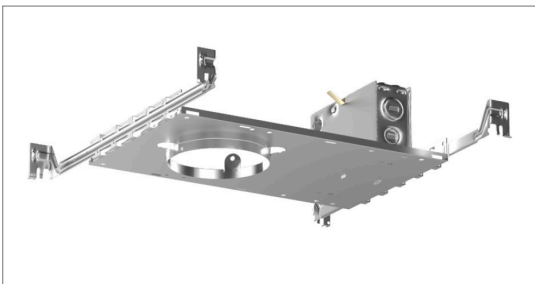

NEW CONSTRUCTION

INSTALLATION

1. Non-IC rated housings must be kept at a minimum of 3" away from insulation.
2. Fixture includes adjustable bar hangers (14"-25") for wood joist or t-bar ceiling installations.
3. Bar hangers can be installed in either direction.
4. Operation temperature: -20°C - 40°C.

DIMENSIONS

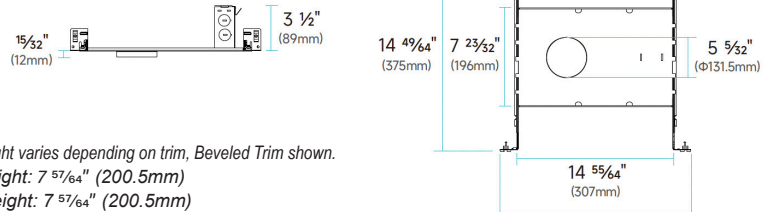

Note: Total height varies depending on trim, Beveled Trim shown.

Minimum height: 7 57/64" (200.5mm)

Maximum height: 7 57/64" (200.5mm)



IC RATED HOUSING

INSTALLATION

1. ETL Listed for direct contact with insulation.
2. Fixture includes adjustable bar hangers (14"-25") for wood joist or t-bar ceiling installations.
3. Bar hangers can be installed in either direction.
4. Operation temperature: -20°C - 40°C.

DIMENSIONS

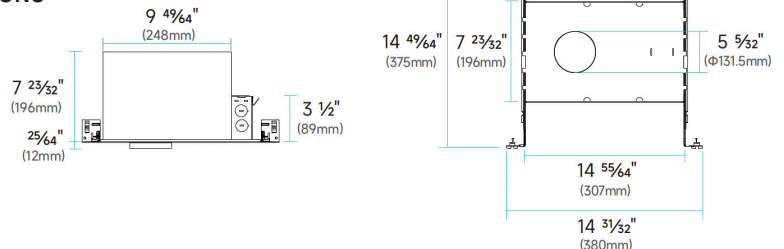

Theoretical Lumens: XXX LM (subject to change)

Theoretical Wattage: XXX W (subject to change)

***Please note lumens and wattage are subject to change and will be determined post production of the first articles.

*Any custom modifications are subject to minimum order quantity. (M.O.Q.)

© VONN Lighting, 2025

