

VELLA 5" HOTEL DOWNLIGHT

VM090-VF91RF01

By VONN Lighting

VONN

PROJECT:

TYPE:

CATALOG#:

DATE:



DESCRIPTION

The VELLA 5" Hotel series is not only an aesthetically designed downlight but also delivers high-quality illumination, thanks to a combination of a precision light beam lens and a secondary reflector. These luminaires blend seamlessly into the ceiling layout, embodying the philosophy of "light instead of luminaires." With a super modular design available in both round and square shapes, as well as adjustable and fixed options in various wattages, the VELLA Hotel series is an excellent choice for creating a unified lighting experience in any environment.

FEATURES

- Elegant & compact in its style, versatile in its use.
- Precise light control, 15°, 24°, 38°, 55° beam lens options.
- Interchangeable different color secondary reflectors for anti-glare and decorative function.
- Super modular design, replacing LED module, trims, beam lens, honeycomb filter and secondary reflectors without any needs for tools.
- 355° rotation and 30° tilt.
- Anti-glare accessories provide maximum visual comfort.
- Service the LED optics and Driver from above the ceiling.



Round



Square

SPECIFICATION

	VM090		
WATTAGE	25 W	30 W	35 W
LUMEN OUTPUT	2279lm	2644lm	3146lm
BEAM OPTICS	Narrow Spot: 15°, Spot: 24°, Flood: 38°, Wide Flood: 55°		
COLOR TEMP.	Static White: 2700K, 3000K, 3500K, 4000K Dim to Warm: 2000K - 3000K		
COLOR QUALITY	80+/90+, 3-step SDCM		
INPUT WATTAGE	25 W	30 W	35 W
INPUT VOLTAGE	120/277V input, 50/60Hz		
POWER FACTOR	Greater than 0.9		
DIMMING TYPE	Triac dimming & 0-10V dimming range: 1%-100%		
CEILING THICKNESS	 Spring clip 3/64" - 25/32" (1mm-20mm)		
INSTALLATION	New Construction, Remodel, IC Rated Housing		
LISTINGS	ETL Listed to US and Canadian standards for damp locations. (IC) ETL listed for direct contact w/insulation.		
WARRANTY	5 year limited warranty		
AMBIENT OPERATING TEMPERATURE	-20°C to 40°C		
SYSTEM RATING	80% of initial lumens at 50000 hours (L80)		

Theoretical Lumens: XXX LM (subject to change)

Theoretical Wattage: XXX W (subject to change)

***Please note lumens and wattage are subject to change and will be determined post production of the first articles.

*Any custom modifications are subject to minimum order quantity. (M.O.Q.)

© VONN Lighting, 2025

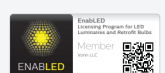

VELLA 5" HOTEL DOWNLIGHT

VM090-VF91RF01

By VONN Lighting



PROJECT:

TYPE:

CATALOG#:

DATE:

ORDERING INFORMATION

VM090	VF	9	1	-	-	-	-	-	-	-	-
Led Module	Trim	Dimensions of trim	Application	Trim Shape	Trim Style	Flangeless Trim	Safety Standard	Voltage	Lumen Output	Dimming Methods	Including Housing
VM090	VF	9 Nominal size: 90mm	1 Hotel	RA Round adjustable	01 Standard	F Flangeless Trim	A American standard	277 120-277V	L08 800lm	V 0-10V	C New Construction
				RF Round fixed				120 100-120V	L12 1200lm	T Triac	R Remodel
				SA Square adjustable						X 0-10V/Triac	H Housing

ACCESSORIES (TO BE ORDERED SEPARATELY)

FOR INSTALLATION CONSULT THE INSTRUCTION SHEET

OPTICAL ACCESSORY

HONEYCOMB FILTER

VM090-H



SOFT LENS

VM090-L



SECONDARY REFLECTOR COLOR

BLACK

VF91RA-SB
VF91RF-SB
VF91SA-SB



BRIGHT SILVER

VF91RA-SS
VF91RF-SS
VF91SA-SS



MATTE SILVER

VF91RA-SM
VF91RF-SM
VF91SA-SM



MATTE WHITE

VF91RA-SW
VF91RF-SW
VF91SA-SW



LUMEN MULTIPLIERS

CCT	MULTIPLIER	CRI	MULTIPLIER	STANDARD TRIM	MULTIPLIER
2700K	0.95	80+	1.23	VF91RA01 (Round adjustable)	1.00
3000K	1.03	90+	1.00	VF91RF01 (Round fixed)	1.00
3500K	1.05			VF91SA01 (Square adjustable)	0.99
4000K	1.02				

Applying Lumen Multipliers to Calculate Delivered Lumens

Base Fixture Delivered Lumens (from PHOTOMETRIC DATA)	x	CCT Multiplier	x	CRI Multiplier	x	TRIM Multiplier	=	Delivered Lumens for Desired Fixture
STANDARD TRIM Example: VM090-VF91SA01 3500K 80+								
2185.9 lm	x	1.05	x	1.23	x	0.99	=	2794.8 lm

Theoretical Lumens: XXX LM (subject to change)

Theoretical Wattage: XXX W (subject to change)

***Please note lumens and wattage are subject to change and will be determined post production of the first articles.

*Any custom modifications are subject to minimum order quantity. (M.O.Q.)

© VONN Lighting, 2025

VONN, LLC.

3323 NE 163rd St. PH-706
North Miami Beach, FL 33160

WWW.VONN.COM 888.604.8666

VONN, LLC. reserves the right to make any design changes for continuous improvement which will not affect the overall appearance or performance.

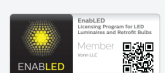

VELLA 5" HOTEL DOWNLIGHT

VM090-VF91RF01

By VONN Lighting



PROJECT:

TYPE:

CATALOG#:

DATE:

PHOTOMETRIC DATA (NON-DIMMING)

CCT (K)	CRI	LOAD (W)	BEAM OPTIC	LUMENS (lm)	EFFICACY (lm/w)	MAX CANDELA (cd)
3000K	90	25W	15°	2185	95	14314
			24°	2227	97	9380
			38°	2279	99	4725
			55°	2154	93	2847
		30W	15°	2544	92	17417
			24°	2578	94	11162
			38°	2644	96	5633
			55°	2500	91	3418
		35W	15°	3059	90	20809
			24°	3090	91	13494
			38°	3146	93	6729
			55°	2940	87	4009

Above test data is based on **Round Adjustable** trim with 3000K 90CRI LED.

VM090-VF91RA01 25W

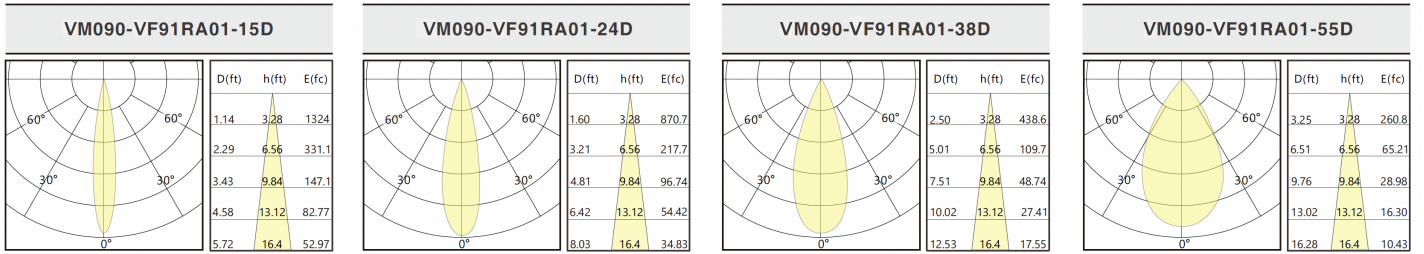

VM090-VF91RA01 30W

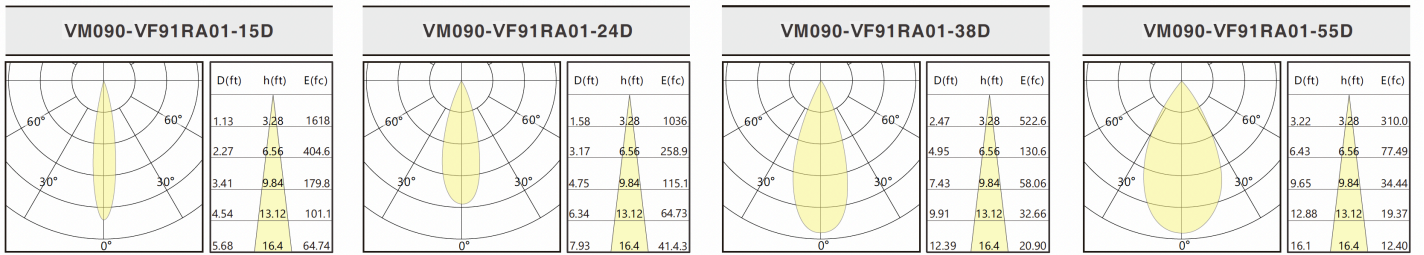

VM090-VF91RA01 35W

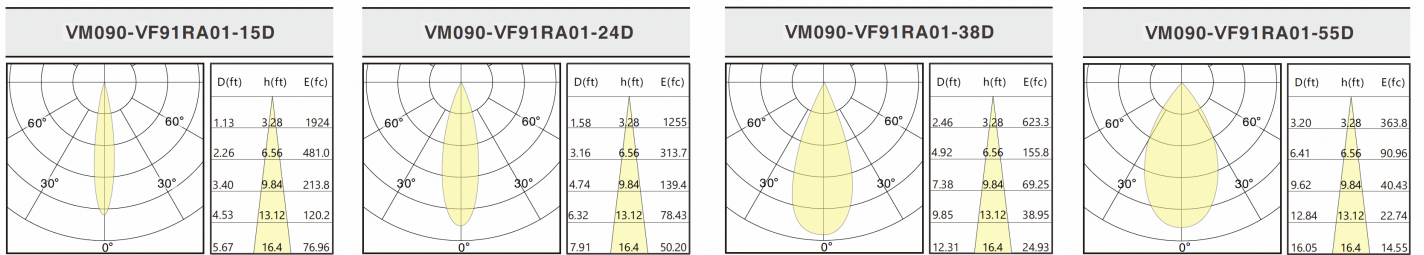

Above test data is based on **Round Adjustable** trim with 3000K 90CRI LED.

Theoretical Lumens: XXX LM (subject to change)

Theoretical Wattage: XXX W (subject to change)

***Please note lumens and wattage are subject to change and will be determined post production of the first articles.

*Any custom modifications are subject to minimum order quantity. (M.O.Q.)

© VONN Lighting, 2025

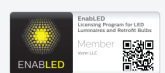

VELLA 5" HOTEL DOWNLIGHT

VM090-VF91RF01

By VONN Lighting

VONN

PROJECT:

TYPE:

CATALOG#:

DATE:

DIMENSION

LED Module

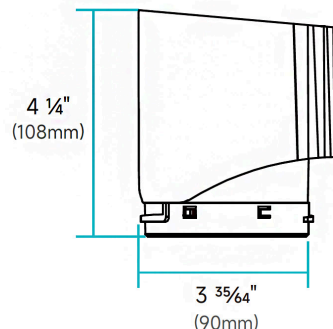

Trim For Hotel Series

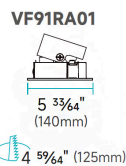
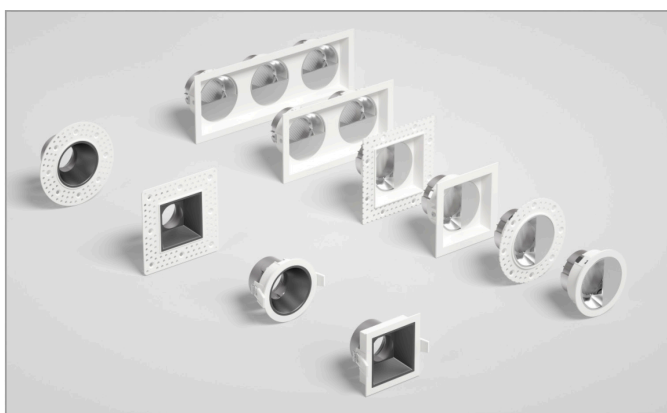

Round Adjustable

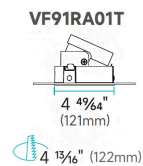

Round Adjustable
Flangeless

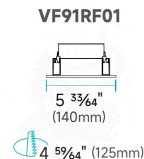

Round Fixed

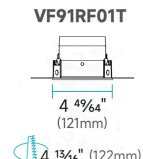

Round Fixed
Flangeless

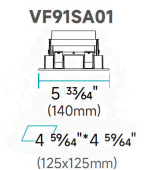

Square Adjustable

Theoretical Lumens: XXX LM (subject to change)

Theoretical Wattage: XXX W (subject to change)

***Please note lumens and wattage are subject to change and will be determined post production of the first articles.

*Any custom modifications are subject to minimum order quantity. (M.O.Q.)

© VONN Lighting, 2025

VONN, LLC.

3323 NE 163rd St. PH-706
North Miami Beach, FL 33160

WWW.VONN.COM 888.604.8666

VONN, LLC. reserves the right to make any design changes for continuous improvement which will not affect the overall appearance or performance.

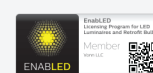

VELLA 5" HOTEL DOWNLIGHT

VM090-VF91RF01

By VONN Lighting

VONN

PROJECT:

TYPE:

CATALOG#:

DATE:

INSTALLATION



REMODEL

INSTALLATION

1. Direct connection with installed housing.
2. Operation temperature: -20°C - 40°C

DIMENSIONS FOR REMODEL MOUNTED DRIVER

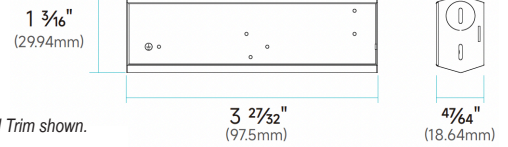

Note: Total height varies depending on trim, Beveled Trim shown.
 Minimum height: 6 $\frac{19}{32}$ " (167.6mm)
 Maximum height: 6 $\frac{57}{64}$ " (175.1mm)



NEW CONSTRUCTION

INSTALLATION

1. Non-IC rated housings must be kept at a minimum of 3" away from insulation.
2. Fixture includes adjustable bar hangers (14"-25") for wood joist or t-bar ceiling installations.
3. Bar hangers can be installed in either direction.
4. Operation temperature: -20°C - 40°C.

DIMENSIONS

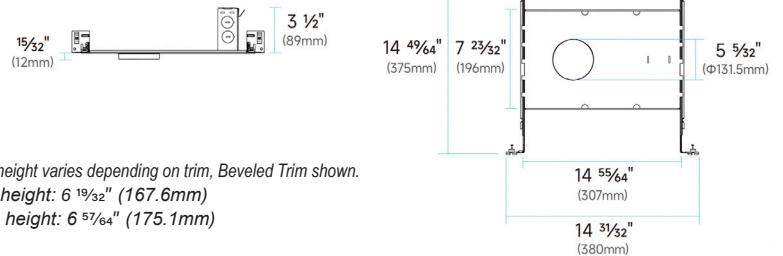

Note: Total height varies depending on trim, Beveled Trim shown.
 Minimum height: 6 $\frac{19}{32}$ " (167.6mm)
 Maximum height: 6 $\frac{57}{64}$ " (175.1mm)



IC RATED HOUSING

INSTALLATION

1. ETL Listed for direct contact with insulation.
2. Fixture includes adjustable bar hangers (14"-25") for wood joist or t-bar ceiling installations.
3. Bar hangers can be installed in either direction.
4. Operation temperature: -20°C - 40°C.

DIMENSIONS

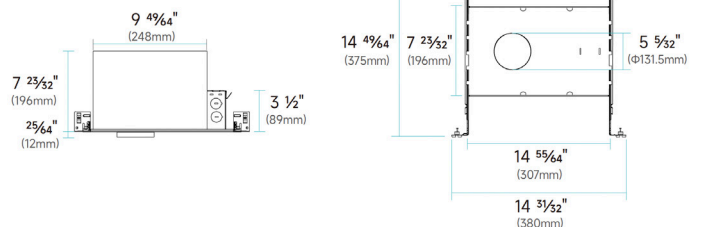

Theoretical Lumens: XXX LM (subject to change)

Theoretical Wattage: XXX W (subject to change)

***Please note lumens and wattage are subject to change and will be determined post production of the first articles.

*Any custom modifications are subject to minimum order quantity. (M.O.Q.)

© VONN Lighting, 2025