

Installation Guide

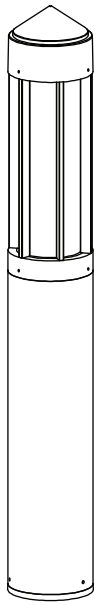

VONN Lighting
Model: VOB38168



LED INFO & WARNINGS

- Please read and comprehend the entire manual before attempting to assemble, operate, or install the product.
- Make sure that you have all necessary parts by checking the parts list. If any part is missing or damaged, please contact **VONN Lighting Customer Service at 888-604-8666** for a replacement.
- All parts must be used as indicated in these instructions. Do not substitute any parts, leave parts out, or use any parts that are worn or broken.
- Inspect the LED fixture prior to installation to make sure that it has not been damaged during shipping.
- Please handle the LED light with care when unpacking. Do not apply pressure to the LED's, do not open any factory sealed compartments, and do not touch the LEDs with your hands.

VONN highly recommends to use a qualified, licensed electrician to install the fixture.

- Do not remove or replace VONN manufactured parts that are provided with the fixture.
- Shut "OFF" the electricity at main fuse box.
- 12V AC Low Voltage Fixture (TRANSFORMER IS REQUIRED)

Parts List

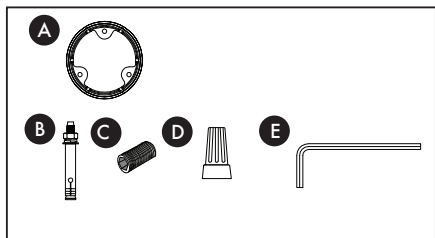

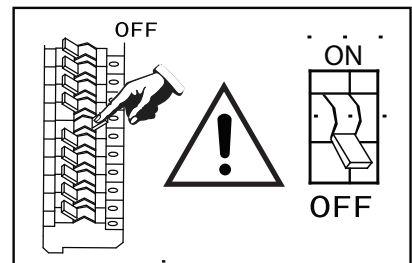

- A. Base Plate
- B. Expansion Bolt x 3
- C. Hex Screws x 3
- D. Wire Connectors x 4
- E. Hex Wrench

Circuit Box

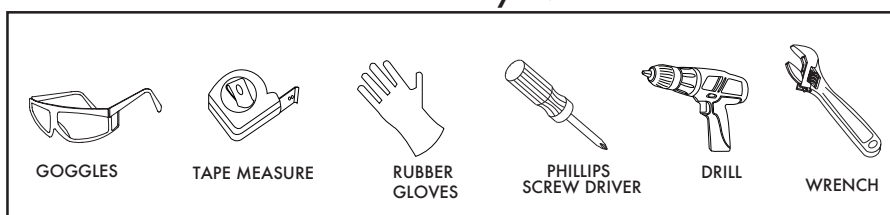

Tools You May Need



Legend
L = Live/Hot/Black
N = Neutral/White
 = Ground/Green

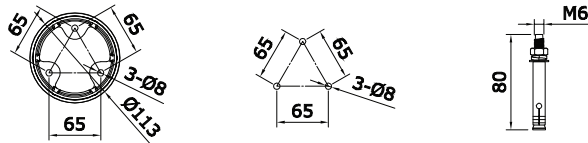

Installation Hole Size



1. Install Base Plate

- 1. Nut
- 2. Lock Washer
- 3. Flat Washer

• Install base plate (A) onto concrete floor with expansion bolts (B). Secure with flat washers, lock washers, and nuts.

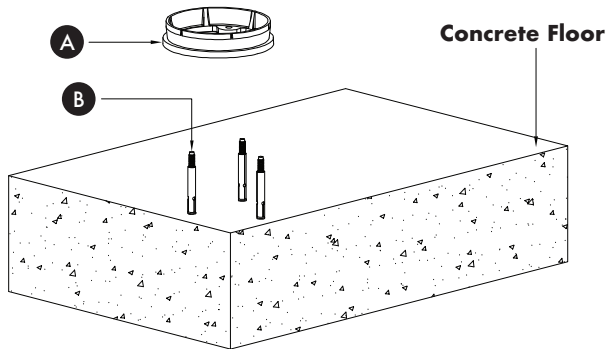

Installer Tip (1): Nut, lock washer, and flat washer are attached to expansion bolt.

2. Supply Wires:

- Bring power wires to fixture location in accordance to local electrical codes.
- Connect Black (Line Wire) from fixture to power Black (Hot Wire).
- Connect White (Neutral Wire) from fixture to power White (Neutral Wire).
- Ground Wires:**
- Connect Green (Ground Wire) from fixture to supply Green (Ground Wire).
- Twist wires together clockwise and secure with wire connector (D).

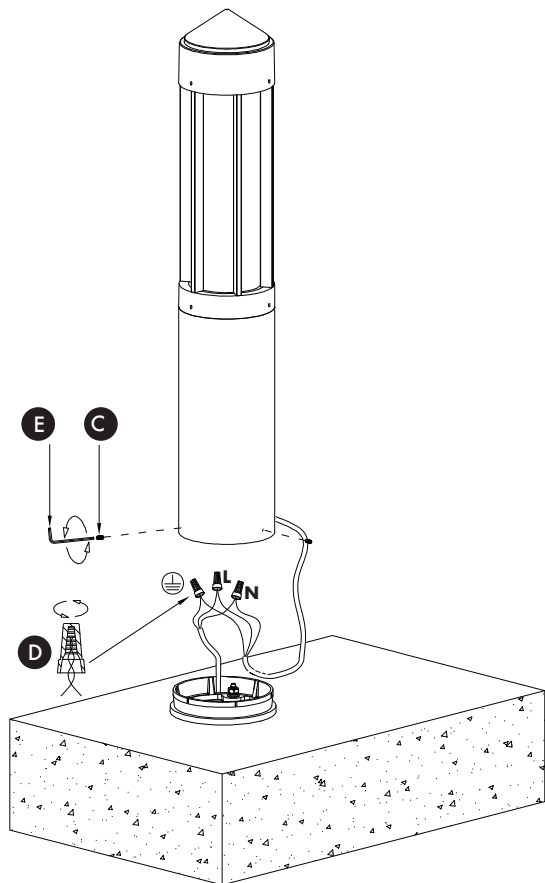

3. Install Bollard

- Install fixture to base plate (A). Secure fixture with hex screw (C). Tighten hex screw (C) with hex wrench (E).

4. Turn Power ON

- Turn electricity "ON" at main fuse box.

Circuit Box

