

- ✓ We supply projector final products.
- ✓ We welcome customers' brands.
- ✓ We supply optical engines.
- ✓ We provide ID design, mold development, and production services.
- ✓ 我们供应不同规格的投影机成品。
- ✓ 我们提供贴牌服务。
- ✓ 我们供应光学引擎(光机)。
- ✓ 我们提供投影机的外观设计, 开模, 以及生产服务, 打造客户专属机种。

Ultra Short Throw(UST)Projector Series

超短焦投影机系列



Ultmost / Manufacturer & Exporter Since 1987

Ultmost Technology Group

(Taiwan Head Office)

Ultmost Technology Corp.

Add.: 4F, No. 52, Ming Chuang Rd., Hsintien, Taipei, Taiwan, R.O.C.

Tel.: 886-2-29179901(Rep.) Fax: 886-2-29177603(Rep.)

(Mainland China Operation)

World Electronic (Shenzhen) Co., Ltd.

Add.: No.160, Longping West Rd, Longgang District, Shenzhen City, Guangdong, China (Zip Code: 518172)

Tel.: 86-755-61292888(Rep.), Fax.: 86-755-61292988(Rep.), E-mail: ut@ultmost.com.cn

Sales Direct Lines: 86-755-84880719(tel.) / 86-755-84880780(tel.) / 86-755-84820817(fax)

<http://www.fussdigital.com>

<http://www.sansuiprojector.com>

CastV HD - Full HD - 4K

the world's shortest throw (ratio 0.2:1) Smart Projectors

FUSS

Polyvision

SANSUI

ODM

Introduction of CasTV - Ultra Short Throw Projector (UST) series	02-06
HD models	07-08
Full HD models	09-10
Full HD (HLD) model	11
4K model	12
Specifications	13-16
Projection Screens	17-19
Subwoofer	20
UST Optical Engines	21-22
超短焦投影机介绍	02-06
高清机型	07-08
全高清机型	09-10
全高清 (高亮度) 机型	11
4K 机型	12
产品规格表	13-16
投影幕	17-19
重低音	20
超短焦光学引擎	21-22



CasTV can project a 100+ image from a very short distance against the wall. Users do not need to deal with the hassle of people blocking the projection, or getting tangled in power cord and signal cables.

- CasTV series is the world's shortest throw (ratio 0.2 : 1) Smart Projectors which take around 10cm to project a 100"+ image:
- They are high-end multi-purpose Multimedia Projectors and can project a 60"-240" image when be positioned at exactly the same spot a TV would be put eliminating the need to run cables any farther than you would with a regular TV.
 - They can access the internet independently. (Wi-Fi and ethernet, 2.4G / 5G)
 - They can play movies from a memory stick, a DVD player, a camcorder , mobile devices, and on-line streaming platforms such as YouTube, Netflix...etc.
 - They can access TV programs through the connection of a TV set up box .
 - They can connect a game console for big screen gaming.
 - Soft reflective light won't strain your eyes for hours of watching.
 - Built with high quality sound system (They also can connect to your own sound system if you preferred.)
 - Compatible to Miracast, and Screen mirroring casting programs for wireless mirroring of a mobile device.
 - Portable, easy to be moved around.
 - All functions are just like a smart TV but the price is dramatically much less than a 100" TV - only around 1% of it.
 - LED light source lasts 20,000 to 30,000 hours and provides vivid images. Image colors won't be fading gradually like laser projectors do.

CasTV 超短焦投影机 (投射比0.2:1)

我们创新的超短焦投影机CasTV系列可以在离墙极短的距离投射出百寸以上的画面。不再有传统投影机各种连接线杂乱穿梭室内, 以及因人员在投影机前走动而影响投影的烦恼。

- CasTV 系列投影机贴墙摆放即可投影超过100"的画面:
- 这是一台高端多用途多媒体投影机, 放在一般客厅电视柜上即可投出60"-240"的大画面。
 - 可直接上连互联网 (Wi-Fi and ethernet, 2.4G / 5G)。
 - 可播放来自U盘, 记忆卡, 影碟机, 录像机, 行动装置内的电影以及线上影音。
 - 可连接机顶盒播放电视节目。
 - 可连接游戏机进行大屏幕游戏。
 - 柔和自然的反射光, 长时间观赏也不会让眼睛感觉疲劳。
 - 内置高品质立体音响系统 (也可外接其他音响设备)。
 - 兼容Miracast, 以及Screen mirroring同屏推送功能(适用所有Android, iOS, Windows, Mac 各平台设备)。
 - 机身轻小, 可轻松任意移动。
 - 性价比高, 功能等同百寸智能电视, 但价格却出乎意料的低廉, 令所有中产阶级的家庭都可负担的起。
 - LED冷光源支持20,000-30,000小时的投影, 影像画面颜色鲜艳, 没有类似激光投影机使用一段时间后色彩会渐渐褪色的缺点。

Wall-side projection, a small room can also have a big view.

墙边投影，小空间也可有大视野。

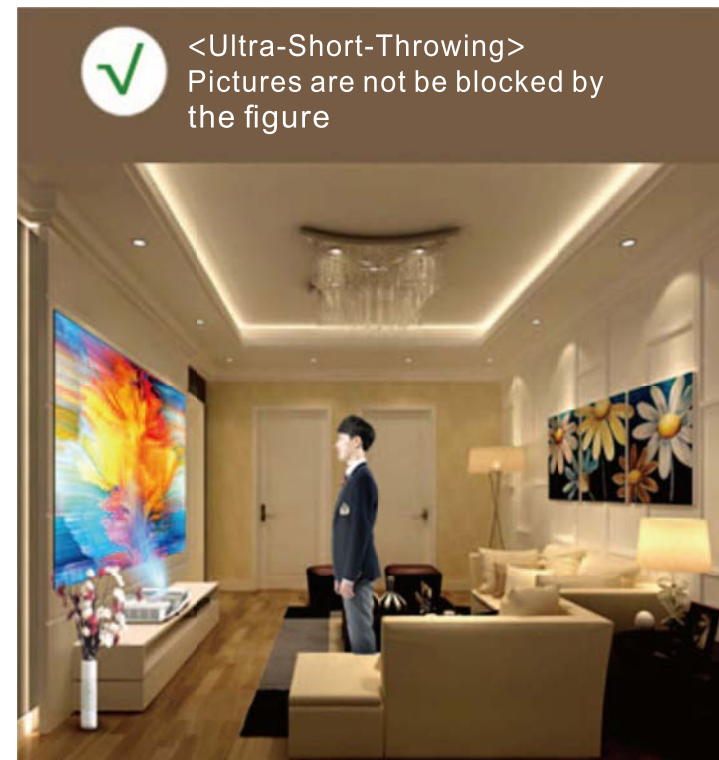
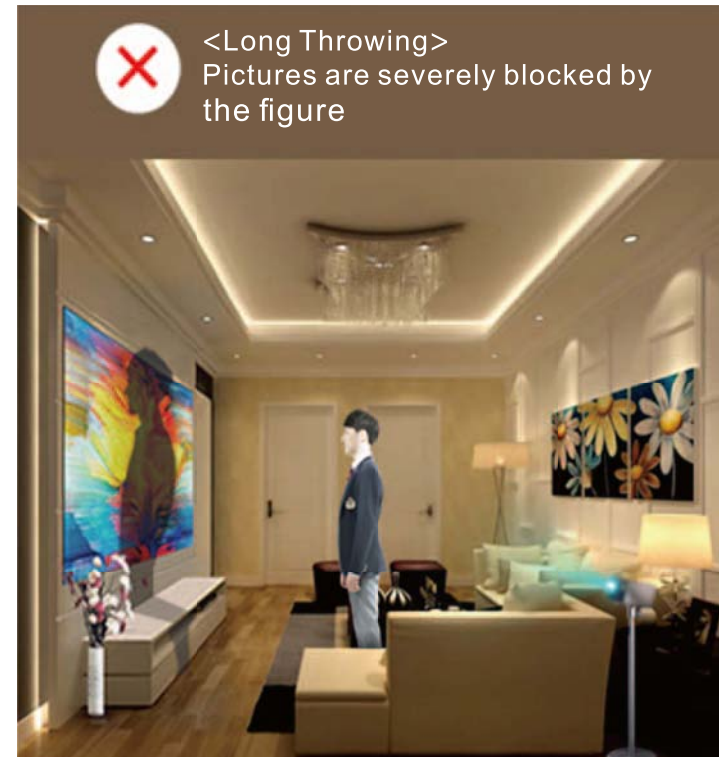
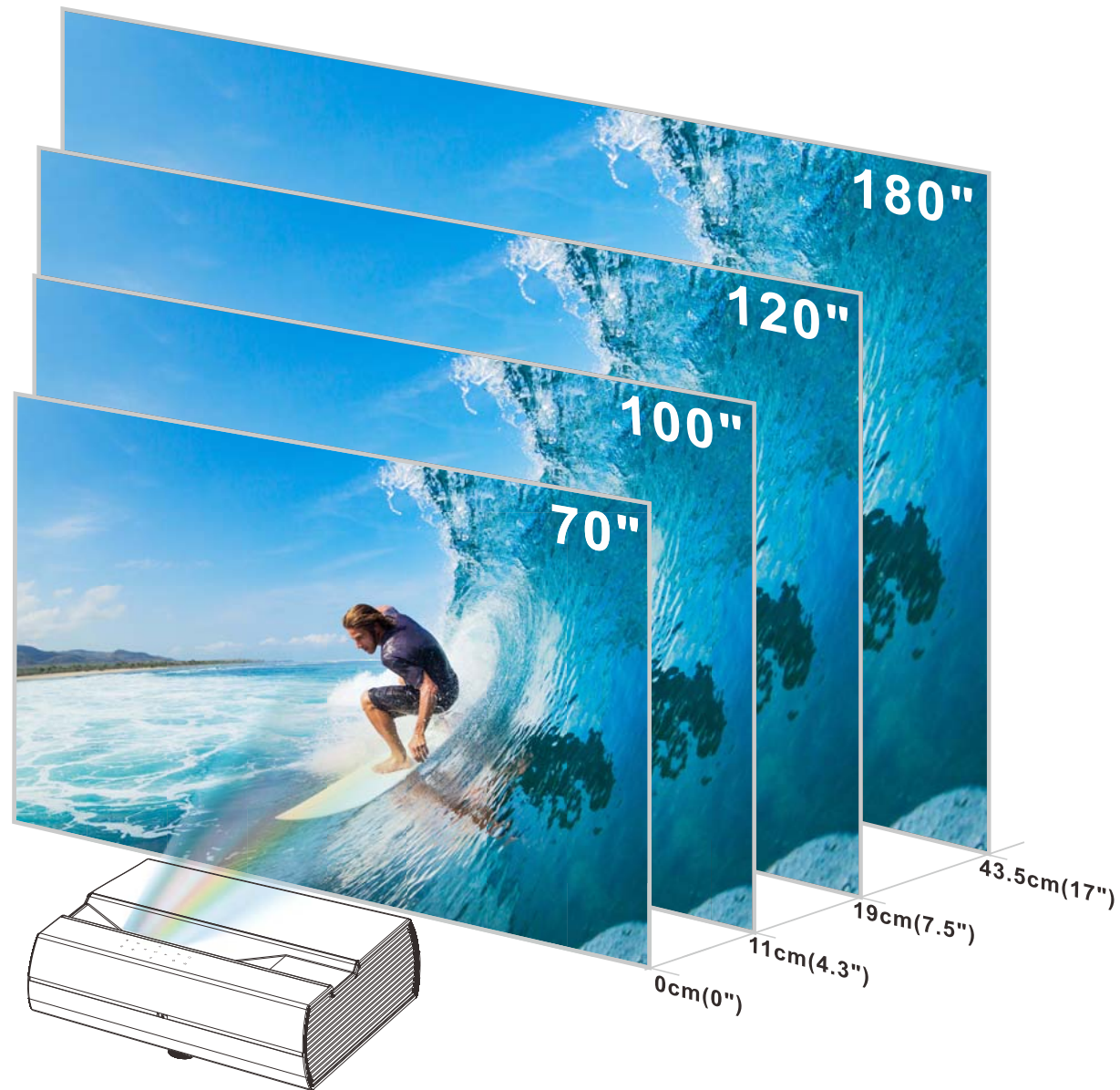

- Application:
- Used as a home-theater movie projector
 - Used as a Smart TV (paired with a TV set top box)
 - Used for meeting room & classroom
 - Used for presentation
 - Used for pub, storefront decoration

Why choose our Ultra-short Throw projectors?

- General advantages:
- Small room can have a big projection
 - Wall-side projection, no need tedious wiring work
 - Projection won't be blocked by people passing by
 - Projection beam won't shoot into eyes of a presenter
 - LED light source, low power consumption; 30,000 hours life, no after cost for bulb changing;
 - no need to warm-up and cool-down when operating;
 - vivid image color (LED's gamut is wider than laser and lamp's),
 - No serious brightness & color decay issues like a laser projector does
 - designed in 100% color brightness ensuring a vivid and in-depth image
 - Built with Android based computer, no need the connection of a PC, easily to access on-line streaming movies
 - Bountiful communication ports, convenient in all kinds of usage

应用:

- 做为家庭影院投影机使用
- 做为智能电视使用(外接机顶盒)
- 用于会议及教室
- 用于商业简报
- 用于酒吧,店面的背景装潢

为何我们的超短焦投影机是您最佳的选择?

优势:

- 小空间也可享受大投影。
- 墙边投影,没有繁杂的布线需要。
- 投影画面不会被经过的人遮挡。
- 投影光束不会射入主讲人眼中。
- 使用绿色环保冷光源,节能省电,30,000小时寿命,无后续更换灯泡的花费。
- 使用时不需要暖机冷机,提高使用便利性。
- 色彩鲜艳(因为LED的色域超越灯泡以及激光的色域)。
- 没有激光投影机严重的光衰问题。
- 100%彩色流明设计,确保画面颜色鲜艳,场景有深度。
- 内建安卓系统,不需外接电脑即可直接接收网络影音串流。
- 丰富的通讯接口,方便各种使用需求。

Myths:

1. Auto keystone is a more advanced design.
Wrong! In modern projectors, keystone correction technology is performed digitally (rather than optically) via the internal (LCD) panels or (DLP) mirrors of the projector, depending on the technology used. Thus, when applying keystone correction to an image, the number of individual pixels used is reduced, lowering the resolution and thus degrading the quality of the image projected. Home theater enthusiasts would argue that keystone correction should not be used because of the impact it has on image quality.
Our CasTV projectors are designed with 3 physical knobs for inclination angle manual adjustment to substitute the use of auto-keystone since auto-keystone would reduce the picture resolution.

2. I should care about contrast ratio.
No! Contrast ratio is probably the most meaningless spec you'll find. Like HDTVs, projectors rely on so-called "dynamic contrast" to boost their on-paper performance. Also, the screen surface plays an important role in contrast. Finally, any ambient light will bring contrast ratio down into the double digits. Unless you have optimal viewing conditions (i.e., virtually no light and a good screen), a 500:1 contrast ratio and a 100,000:1 contrast ratio on paper probably won't render a visible difference.

误解:

1.自动梯形校正为较先进的设计。
错误!现代投影机的自动梯形校正科技是以数字方式(非光学方式)透过内部的显示器处理,在对影像做梯形校正时,影像的像素会减少,清晰度会较差,投影画面的质量会降低,因此投影机玩家主张自动梯形校正技术不应该被应用到投影机内。
我们的CasTV投影机使用三个物理调整钮调整投影角度,无自动梯形校正造成投影质量下降的问题。

2.我应该在意投影机对比度的大小。
不!对比度可能是一个最没有意义的规格数字,如同高清电视,投影机使用动态对比度来提升在纸上的投影对比度比值。同时,投影平面的条件在对比度上也扮演了一个极重要的角色。最终,任何环境光都会把对比度数字降到二位数字,除非有良好的投影条件(譬如:无环境光的干扰以及一块好的投影幕),否则一台500:1对比度的投影机与一台100,000:1投影机在白纸上投影表现是没有大差异的。

Applications 应用:



for Home Theater
家庭影院



for Living Room / Family Room
家庭大屏幕投影电视



for Private Room/Hotel's Guest Room
家庭的第二台电视 / 旅馆客房



for Big-screen Gaming
大屏游戏



for Interior Design
室内装潢设计

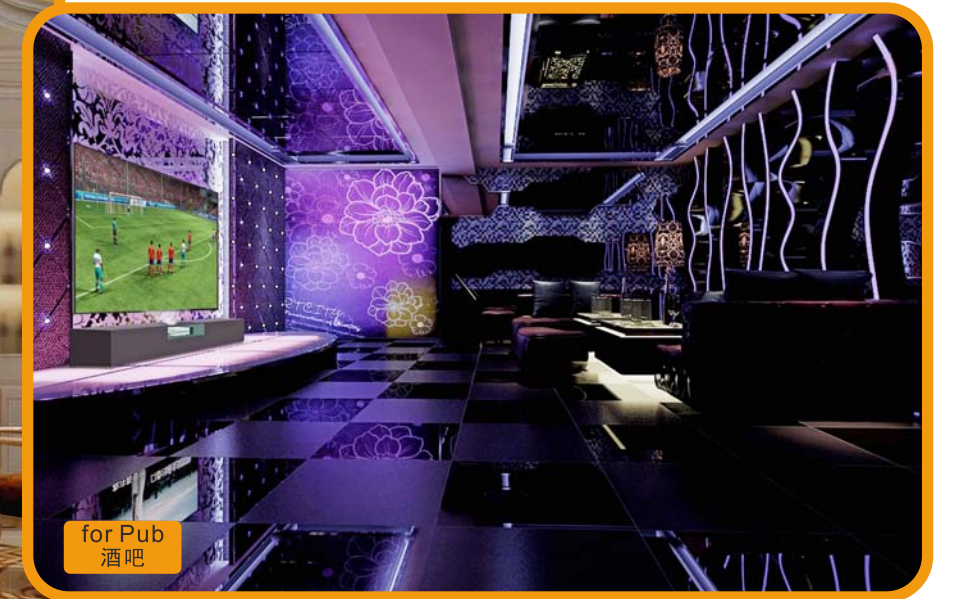

for Pub
酒吧



for Karaoke
卡拉OK



for Shopping Window
橱窗背景



for Business Presentation
商务简报

HD

CasTV - Ultra-short Throw Projector series / 超短焦投影系列



- DLP imaging technology
- Throw ratio 0.2:1
- Takes 2-76cm (0.8-30") distance to project a 60-180" image
- LED light source (30,000 hours)
- High Definition (1280 x 800 pixels, native resolution):
(Android/WiFi models support 4K decoding)
- 2800 LM / 3600 LM / 4200 LM (light source)
- Luminous efficiency 25%
- Android OS, LAN, Dual-band Wi-Fi
- Equal white / color brightness ensuring vivid color and image in depth

- DLP显像技术
- 0.2:1 投射比
- 2-76cm距离可投影60-180"
- LED光源(30,000小时)
- 高清影像(1280 x 800 pixels, 原生解析度):(安卓/WiFi机种支持4K解码)
- 2800流明 / 3600流明 / 4200流明(光源)
- 光效 25%
- 安卓操作系统, LAN, 双频Wi-Fi
- 彩色流明与白光流明一致, 确保画面颜色鲜艳, 场景有深度



► **FP-366A** (Android/WiFi model)
FPB366A (non-Android/WiFi model)
Brightness: 3600LM, 4200LM
Dimension: 365×345×124mm
14.4×13.6×4.9(inch)
Weight: 5.2kg / 11.5pound



◀ **FP-365C** (Android/WiFi model)
FPB365C (non-Android/WiFi model)
Brightness: 2800LM
Dimension: 310×205×110mm
12.2×8×4.3(inch)
Weight: 2.1kg / 4.6pound

CasTV - Ultra-short Throw Projector series / 超短焦投影系列

HD



► **FP-370A** (Android/WiFi model)
FPB370A (non-Android/WiFi model)
Brightness: 3600LM, 4200LM
Dimension: 365×345×124mm
14.4×13.6×4.9(inch)
Weight: 5.2kg / 11.5pound



◀ **FP-367A** (Android/WiFi model)
FPB367A (non-Android/WiFi model)
Brightness: 3600LM, 4200LM
Dimension: 417×360×125mm
16.4×14.2×4.9(inch)
Weight: 5.4kg / 11.9pound

Communication ports 通讯接口

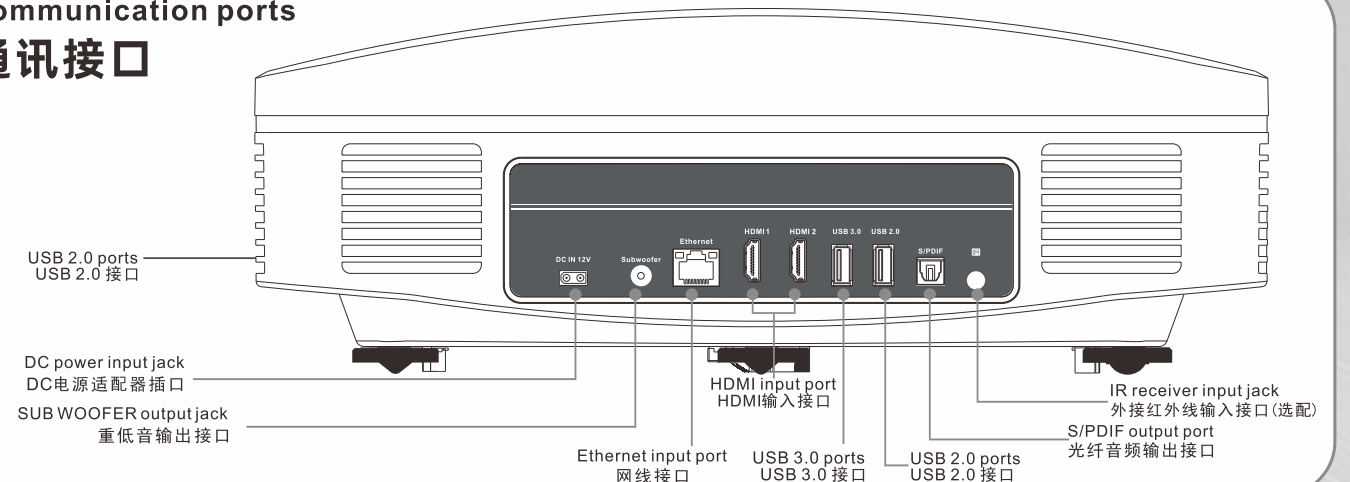

FULL HD

CasTV - Ultra-short Throw Projector series / 超短焦投影系列



- DLP imaging technology
- Throw ratio 0.2:1
Takes 3-38cm(0.8-15") distance to project 80-180" image
- LED light source (30,000 hours)
- Full HD 1080P (1920 x 1080 pixels, native resolution);
(Android/WiFi models support 4K decoding)
- 2800 LM / 3600 LM / 4200 LM (light source)
- Luminous efficiency 25%
- Android OS, LAN, Dual-band Wi-Fi
- Equal white / color brightness ensuring vivid color and image in depth

- DLP显像技术
- 0.2:1 投射比
3-38cm距离可投影80-180"
- LED光源(30,000小时)
- 超清影像(1920 X 1080 pixels,原生解析度):(安卓/WiFi机种支持4K解码)
- 2800流明 / 3600流明 / 4200流明(光源)
- 光效 25%
- 安卓操作系统, LAN, 双频Wi-Fi
- 彩色流明与白光流明一致, 确保画面颜色鲜艳, 场景有深度

▶ **FP-366B** (Android/WiFi model)
FPB366B (non-Android/WiFi model)
Brightness: 3600LM, 4200LM
Dimension: 365×345×124mm
14.4×13.6×4.9(inch)
Weight: 5.2kg / 11.5pound



Communication ports
通讯接口

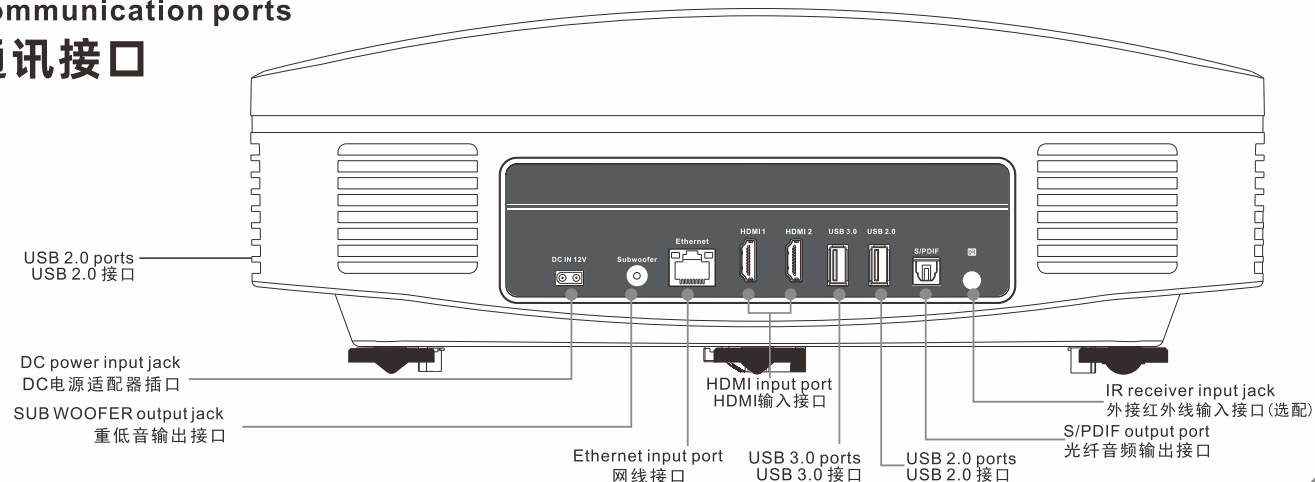

CasTV - Ultra-short Throw Projector series / 超短焦投影系列

FULL HD

▶ **FP-371B** (Android/WiFi model)
FPB371B (non-Android/WiFi model)
Brightness: 3600LM, 4200LM
Dimension: 363×350×112mm
14.3×13.8×4.4(inch)
Weight: 5.7kg / 12.6pound



◀ **FP-373B** (Android/WiFi model)
FPB373B (non-Android/WiFi model)
Brightness: 3600LM, 4200LM
Dimension: 371×318×121mm
14.6×12.5×4.8(inch)
Weight: 5.2kg / 11.5pound



Communication ports
通讯接口
(FP-371B)

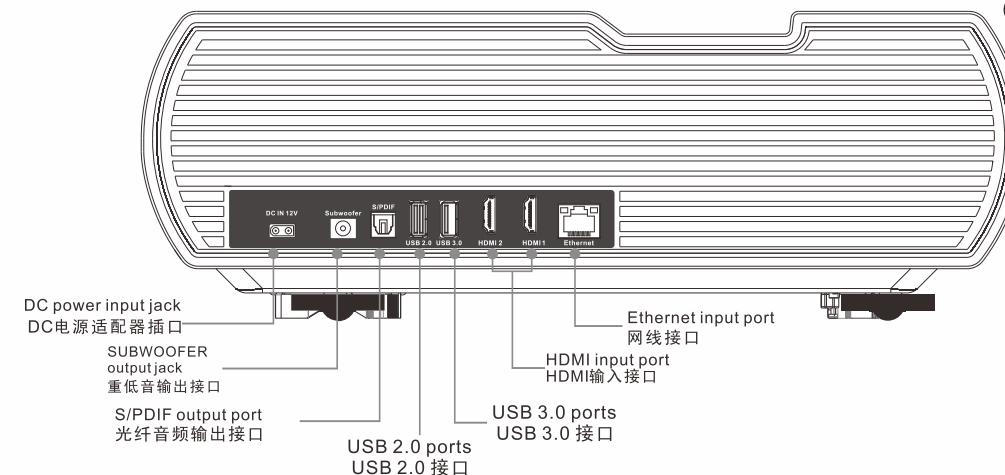

FULL HD
(HLD)

High Lumen Density



CasTV - Ultra-short Throw Projector series / 超短焦投影系列



- DLP imaging technology
- Throw ratio 0.2:1
Takes 2-46cm(0.8-18") distance to project 70-180" image
- LED light source (30,000 hours)
- Full HD 1080P (1920 x 1080 pixels, native resolution);
(Android/WiFi models support 4K decoding)
- 6000 LM (light source)
- Luminous efficiency 25%
- Android OS, LAN, Dual-band Wi-Fi
- Equal white / color brightness ensuring vivid color and image in depth
- DLP显像技术
- 0.2:1 投射比
2-46cm 距离可投影70-180"
- LED 光源 (30,000小时)
- 超清影像 (1920 x 1080 pixels, 原生解析度); (安卓/WiFi机种支持4K解码)
- 6000 流明(光源)
- 光效 25%
- 安卓操作系统, LAN, 双频Wi-Fi
- 彩色流明与白光流明一致, 确保画面颜色鲜艳, 场景有深度

CasTV - Ultra-short Throw Projector series / 超短焦投影系列



- DLP imaging technology
- Throw ratio 0.2:1
Takes 3-38 cm(0.8-15") distance to project 80-180" image
- LED light source (30,000 hours)
- ULTRA HD(4K,3840 x 2160 pixels,native resolution)
- 3600LM / 4200LM (light source)
- Luminous efficiency 25%
- Android OS, LAN, Dual-band Wi-Fi
- Equal white / color brightness ensuring vivid color and image in depth
- DLP显像技术
- 0.2:1 投射比
3-38 cm距离可投影80-180"
- LED 光源 (30,000小时)
- 4K影像 (3840 x 2160 pixels, 原生解析度)
- 3600流明 / 4200 流明(光源)
- 光效 25%
- 安卓操作系统, LAN, 双频Wi-Fi
- 彩色流明与白光流明一致, 确保画面颜色鲜艳, 场景有深度

4K



▲ **FP-372B** (Android/WiFi model)
FPB372B (non-Android/WiFi model)
Brightness: 6000LM
Dimension: 371×318×121mm
14.6×12.5×4.8(inch)
Weight: 5.2kg / 11.5pound



▲ **FP-371C** (Android/WiFi model)
Brightness: 3600LM, 4200LM
Dimension: 363×350×112mm
14.3×13.8×4.4(inch)
Weight: 5.7kg / 12.5pound

Specifications / 产品规格表

Specification		Model No.	FP-365C/D-100 (HD)	FP-366A/D-101 (HD)	FP-366B (1080P)	FP-370A/U-100 (HD)
Page			07	07	09	08
Imaging technology			DLP	DLP	DLP	DLP
Light source			LED	LED	LED	LED
Brightness (light source)			2800 lumens	3600 lumens, 4200lumens	3600 lumens, 4200lumens	3600 lumens, 4200lumens
Color brightness : white brightness			100% equal	100% equal	100% equal	100% equal
Luminous efficiency			25%	25%	25%	25%
Native resolution (pixels)			1280×800	1280×800	1920×1080	1280×800
Maximum resolution support			4 K	4 K	4 K	4 K
LED life (hours)			30000	30000	30000	30000
Throw ratio			0.2:1	0.2:1	0.2:1	0.2:1
Projection size(can go bigger, however the image quality could be compromised)			60"~180"	70"~180"	80"~180"	70"~180"
Projection distance (from front edge to wall)			0.02m~0.76m	0.03m~0.46m	0.03m~0.38m	0.03m~0.46m
File decoder (for USB drive & memory card)	Video file format		MKV, WMV, MPG, DAT, MPEG, AVI, MOV, MP4, RM, F4A, FVV, RMVI	MKV, WMV, MPG, DAT, MPEG, AVI, MOV, MP4, RM, F4A, FVV, RMVI	MKV, WMV, MPG, DAT, MPEG, AVI, MOV, MP4, RM, F4A, FVV, RMVI	MKV, WMV, MPG, DAT, MPEG, AVI, MOV, MP4, RM, F4A, FVV, RMVI
	Audio file format		M4A, M4R, MP2, MP3, OGG, WAV, AAC, AMV CPE, FLAC	M4A, M4R, MP2, MP3, OGG, WAV, AAC, AMV CPE, FLAC	M4A, M4R, MP2, MP3, OGG, WAV, AAC, AMV CPE, FLAC	M4A, M4R, MP2, MP3, OGG, WAV, AAC, AMV CPE, FLAC
	Picture file format		JPEG, BMP, GIF, PNG	JPEG, BMP, GIF, PNG	JPEG, BMP, GIF, PNG	JPEG, BMP, GIF, PNG
	Document file format		TXT, PDF, OFFICE (with APK GIF, PNG)	TXT, PDF, OFFICE (with APK GIF, PNG)	TXT, PDF, OFFICE (with APK GIF, PNG)	TXT, PDF, OFFICE (with APK GIF, PNG)
Input	USB host		Yes(2)	Yes(3)	Yes(3)	Yes(3)
	HDMI		Yes(2)	Yes(2)	Yes(2)	Yes(2)
Operating system			Android	Android	Android	Android
Processor			Quad Core	Quad Core	Quad Core	Quad Core
Wi-Fi			2.4G & 5G	2.4G & 5G	2.4G & 5G	2.4G & 5G
Ethernet (LAN)			Yes	Yes	Yes	Yes
Casting	DLNA		Yes	Yes	Yes	Yes
	Miracast		Yes	Yes	Yes	Yes
	Screen mirroring		Yes	Yes	Yes	Yes
Remote control			Yes	Yes	Yes	Yes
Speaker			5W×1	10W×2 / 40W×1	10W×2 / 40W×1	10W×2 / 40W×1
Audio output (Bluetooth)			Yes	Yes	Yes	Yes
Audio output (optical,S/PDIF)			Yes	Yes	Yes	Yes
Subwoofer output			-	Yes	Yes	Yes
Power supply			DC12V / 8A	DC12V / 10A DC12V / 18A	DC12V / 10A DC12V / 18A	DC12V / 10A DC12V / 18A
Dimension (unit only) Weight (unit only)			310×205×120mm 12.2"×8.1"×4.7" 2.1kg/4.6pound	365×345×124mm 14.4"×13.6"×4.9" 4.3kg/9.5pound	365×345×124mm 14.4"×13.6"×4.9" 4.6kg/10.1pound	365×345×124mm 14.4"×13.6"×4.9" 4.6kg/10.1pound
Dimension (whole package) Weight (whole package)			450×280×300mm 17.7"×11"×11.8" 5.2kg/11.5pound	480×210×470mm 18.9"×8.3"×18.5" 7.5kg/16.5pound	480×210×470mm 18.9"×8.3"×18.5" 7.8kg/17.2pound	480×210×470mm 18.9"×8.3"×18.5" 7.8kg/17.2pound

Specifications / 产品规格表

FP-367A (HD)	FP-371B/U-200 (1080P)	FP-371C (4K)	FP-372B/D-400/U-400 (1080P)	FP-373B/D-200 (1080P)
08	10	12	11	10
DLP	DLP	DLP	DLP	DLP
LED	LED	LED	LED	LED
3600 lumens, 4200lumens	3600 lumens, 4200lumens	3600 lumens, 4200lumens	6000 lumens (FP-372B, U-400) 7200 lumens (D-400)	3600 lumens, 4200lumens
100% equal	100% equal	100% equal	100% equal	100% equal
25%	25%	25%	25%	25%
1280×800	1920×1080	3840×2160	1920×1080	1920×1080
4 K	4 K	4 K	4 K	4 K
30000	30000	30000	30000	30000
0.2:1	0.2:1	0.2:1	0.2:1	0.2:1
70"~180"	80"~180"	80"~180"	70"~180"	80"~180"
0.03m~0.46m	0.03m~0.38m	0.03m~0.38m	0.02m~0.46m	0.03m~0.38m
MKV, WMV, MPG, DAT, MPEG, AVI, MOV, MP4, RM, F4A, FVV, RMVI	MKV, WMV, MPG, DAT, MPEG, AVI, MOV, MP4, RM, F4A, FVV, RMVI	MKV, WMV, MPG, DAT, MPEG, AVI, MOV, MP4, RM, F4A, FVV, RMVI	MKV, WMV, MPG, DAT, MPEG, AVI, MOV, MP4, RM, F4A, FVV, RMVI	MKV, WMV, MPG, DAT, MPEG, AVI, MOV, MP4, RM, F4A, FVV, RMVI
M4A, M4R, MP2, MP3, OGG, WAV, AAC, AMV CPE, FLAC	M4A, M4R, MP2, MP3, OGG, WAV, AAC, AMV CPE, FLAC	M4A, M4R, MP2, MP3, OGG, WAV, AAC, AMV CPE, FLAC	M4A, M4R, MP2, MP3, OGG, WAV, AAC, AMV CPE, FLAC	M4A, M4R, MP2, MP3, OGG, WAV, AAC, AMV CPE, FLAC
JPEG, BMP, GIF, PNG	JPEG, BMP, GIF, PNG	JPEG, BMP, GIF, PNG	JPEG, BMP, GIF, PNG	JPEG, BMP, GIF, PNG
TXT, PDF, OFFICE (with APK GIF, PNG)	TXT, PDF, OFFICE (with APK GIF, PNG)	TXT, PDF, OFFICE (with APK GIF, PNG)	TXT, PDF, OFFICE (with APK GIF, PNG)	TXT, PDF, OFFICE (with APK GIF, PNG)
Yes(3)	Yes(3)	Yes(3)	Yes(2)	Yes(3)
Yes(2)	Yes(2)	Yes(2)	Yes(2)	Yes(2)
Android	Android	Android	Android	Android
Quad Core	Quad Core	Quad Core	Quad Core	Quad Core
2.4G & 5G	2.4G & 5G	2.4G & 5G	2.4G & 5G	2.4G & 5G
Yes	Yes	Yes	Yes	Yes
Yes	Yes	Yes	Yes	Yes
Yes	Yes	Yes	Yes	Yes
Yes	Yes	Yes	Yes	Yes
10W×2 / 40W×1	10W×2 / 40W×1	10W×2 / 40W×1	10W×2 / 40W×1	10W×2 / 40W×1
Yes	Yes	Yes	Yes	Yes
Yes	Yes	Yes	Yes	Yes
Yes	Yes	Yes	Yes	Yes
DC12V / 10A DC12V / 18A	DC12V / 10A DC12V / 18A	DC12V / 10A DC12V / 18A	DC 60V/5A+DC 12V/8A	DC12V / 10A DC12V / 18A
417×360×125mm 16.4"×14.2"×4.9" 4.6kg/10.1pound	363×350×112mm 14.3"×13.8"×4.4" 5.7kg/12.5pound	363×350×112mm 14.3"×13.8"×4.4" 5.7kg/12.5pound	371×318×121mm 14.6"×12.5"×4.8" 5.2kg/11.5pound	371×318×121mm 14.6"×12.5"×4.8" 5.2kg/11.5pound
520×210×470mm 20.5"×8.3"×18.5" 7.8kg/17.2pound	520×470×260mm 20.5"×18.5"×10.2" 9.2kg/20.3pound	520×470×260mm 20.5"×18.5"×10.2" 9.2kg/20.3pound	520×470×260mm 20.5"×18.5"×10.2" 9.7kg/21.4pound	520×470×260mm 20.5"×18.5"×10.2" 8.9kg/19.6pound

Specifications subject to change without notice.

Specifications / 产品规格表

Specification	Model No.	FPB365C (HD)	FPB366A (HD)	FPB366B (1080P)
Page		07	07	09
Imaging technology		DLP	DLP	DLP
Light source		LED	LED	LED
Brightness (light source)		2800 lumens	3600 lumens, 4200lumens	3600 lumens, 4200lumens
Color brightness : white brightness		100% equal	100% equal	100% equal
Luminous efficiency		25%	25%	25%
Native resolution (pixels)		1280×800	1280×800	1920×1080
LED life (hours)		30000	30000	30000
Throw ratio		0.2:1	0.2:1	0.2:1
Projection size(can go bigger, however the image quality could be compromised)		60"~180"	70"~180"	80"~180"
Projection distance (from front edge to wall)		0.02m~0.76m	0.03m~0.46m	0.03m~0.38m
File decoder (for USB drive & memory card)	Video file format	AVI, MP4, MPG, RMVB/RM, MJPEG, MKV	AVI, MP4, MPG, RMVB/RM, MJPEG, MKV	AVI, MP4, MPG, RMVB/RM, MJPEG, MKV
	Audio file format	MP3, WMA, W4A, WAV, AAC	MP3, WMA, W4A, WAV, AAC	MP3, WMA, W4A, WAV, AAC
	Picture file format	JPG, BMP, PNG	JPG, BMP, PNG	JPG, BMP, PNG
	Document file format	TXT	TXT	TXT
Input	USB host	Yes(2)	Yes(2)	Yes(2)
	CVBS (RCA)	Yes	Yes	Yes
	HDMI	Yes(2)	Yes(2)	Yes(2)
Remote control		Yes	Yes	Yes
Speaker		5W×1	10W×2 / 40W×1	10W×2 / 40W×1
Audio output (optical,S/PDIF)		Yes	Yes	Yes
Subwoofer output		-	Yes	Yes
Power supply		DC12V / 8A	DC20V / 2A+DC12V / 10A DC20V / 2A+DC12V / 18A	DC20V / 2A+DC12V / 10A DC20V / 2A+DC12V / 18A
Dimension (unit only) Weight (unit only)		310×205×120mm 12.2"×8.1"×4.7" 2.1kg/4.6pound	365×345×124mm 14.4"×13.6"×4.9" 4.3kg/9.5pound	365×345×124mm 14.4"×13.6"×4.9" 4.6kg/10.1pound
Dimension (whole package) Weight (whole package)		450×280×300mm 17.7"×11"×11.8" 5.2kg/11.5pound	480×210×470mm 18.9"×8.3"×18.5" 7.5kg/16.5pound	480×210×470mm 18.9"×8.3"×18.5" 7.8kg/17.2pound

Specifications / 产品规格表

Specification	Model No.	FPB370A (HD)	FPB367A (HD)	FPB371B (1080P)	FPB372B (1080P)	FPB373B (1080P)
Page		08	08	10	11	10
Imaging technology		DLP	DLP	DLP	DLP	DLP
Light source		LED	LED	LED	LED	LED
Brightness (light source)		3600 lumens, 4200lumens	3600 lumens, 4200lumens	3600 lumens, 4200lumens	6000lumens	3600 lumens, 4200lumens
Color brightness : white brightness		100% equal	100% equal	100% equal	100% equal	100% equal
Luminous efficiency		25%	25%	25%	25%	25%
Native resolution (pixels)		1280×800	1280×800	1920×1080	1920×1080	1920×1080
LED life (hours)		30000	30000	30000	30000	30000
Throw ratio		0.2:1	0.2:1	0.2:1	0.2:1	0.2:1
Projection size(can go bigger, however the image quality could be compromised)		70"~180"	70"~180"	80"~180"	70"~180"	80"~180"
Projection distance (from front edge to wall)		0.03m~0.46m	0.03m~0.46m	0.03m~0.38m	0.02m~0.46m	0.03m~0.38m
File decoder (for USB drive & memory card)	Video file format	AVI, MP4, MPG, RMVB/RM, MJPEG, MKV	AVI, MP4, MPG, RMVB/RM, MJPEG, MKV	AVI, MP4, MPG, RMVB/RM, MJPEG, MKV	AVI, MP4, MPG, RMVB/RM, MJPEG, MKV	AVI, MP4, MPG, RMVB/RM, MJPEG, MKV
	Audio file format	MP3, WMA, W4A, WAV, AAC	MP3, WMA, W4A, WAV, AAC	MP3, WMA, W4A, WAV, AAC	MP3, WMA, W4A, WAV, AAC	MP3, WMA, W4A, WAV, AAC
	Picture file format	JPG, BMP, PNG	JPG, BMP, PNG	JPG, BMP, PNG	JPG, BMP, PNG	JPG, BMP, PNG
	Document file format	TXT	TXT	TXT	TXT	TXT
Input	USB host	Yes(2)	Yes(2)	Yes(2)	Yes(2)	Yes(2)
	CVBS (RCA)	Yes	Yes	Yes	Yes	Yes
	HDMI	Yes(2)	Yes(2)	Yes(2)	Yes(2)	Yes(2)
Remote control		Yes	Yes	Yes	Yes	Yes
Speaker		10W×2 / 40W×1	10W×2 / 40W×1	10W×2 / 40W×1	10W×2 / 40W×1	10W×2 / 40W×1
Audio output (optical,S/PDIF)		Yes	Yes	Yes	Yes	Yes
Subwoofer output		Yes	Yes	Yes	Yes	Yes
Power supply		DC20V / 2A+DC12V / 10A DC20V / 2A+DC12V / 18A	DC20V / 2A+DC12V / 10A DC20V / 2A+DC12V / 18A	DC20V / 2A+DC12V / 10A DC20V / 2A+DC12V / 18A	DC60V / 5A+DC12V / 8A	DC20V / 2A+DC12V / 10A DC20V / 2A+DC12V / 18A
Dimension (unit only) Weight (unit only)		365×345×124mm 14.4"×13.6"×4.9" 4.6kg/10.1pound	417×360×125mm 16.4"×14.2"×4.9" 4.6kg/10.1pound	363×350×112mm 14.3"×13.8"×4.4" 5.7kg/12.5pound	371×318×121mm 14.6"×12.5"×4.8" 5.2kg/11.5pound	371×318×121mm 14.6"×12.5"×4.8" 5.2kg/11.5pound
Dimension (whole package) Weight (whole package)		480×210×470mm 18.9"×8.3"×18.5" 7.8kg/17.2pound	520×210×470mm 20.5"×8.3"×18.5" 7.8kg/17.2pound	520×470×260mm 20.5"×18.5"×10.2" 9.2kg/20.3pound	520×470×260mm 20.5"×18.5"×10.2" 9.7kg/21.4pound	520×470×260mm 20.5"×18.5"×10.2" 8.9kg/19.6pound

Specifications subject to change without notice.

PROJECTION SCREEN

- Regular
- Ambient-light Rejecting

Projection Screen / 投影幕

As most of walls are not flat enough for ultra-short throw projector, we highly recommend you to acquire a framed projection screen or a tab-tensioned motorized projection screen to use with the projector. If you wish to prepare a projection screen/wall yourself, please use MDF (medium density fiber) boards to build them. If you wish the projection can be watched under a bright-lit room, we suggest you to use an Ambient-light-rejecting Projection Screen which can not only provide a perfect flat surface for projection but also can ward off the light from front ceiling and add contrast to the projection image.

因为大部分的墙面的平整度都不够超短焦投影机的需要，我们强烈建议要搭配使用画框幕或拉线电动幕。如果您想自建一块投影墙，请使用中密度合成板制作，可以满足需要。

如果您想能够在较明亮的环境下使用投影机，可搭配一块抗环境光的投影幕使用。一块抗环境光的投影幕不仅可以提供一个平整的投影面，还可以遮挡掉来自前方天花板灯光光害，增加投影画面对比度。

Projection Screen / 投影幕

Item no.:
•SRD1610 (desktop)
•SRF1610 (floor-stand)

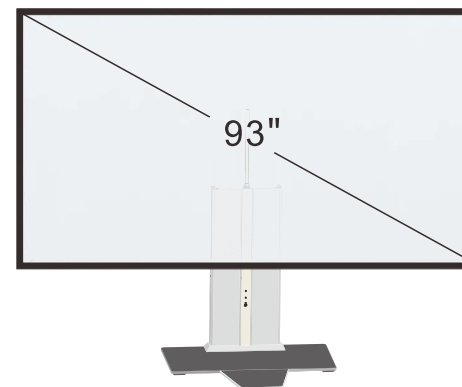

16:10 • desktop / floor-stand regular screen
• with powered height adjustment mechanism
桌上款/落地款普通幕(电动升降)

Item no.:
•SRD1609 (desktop)
•SRF1609 (floor-stand)

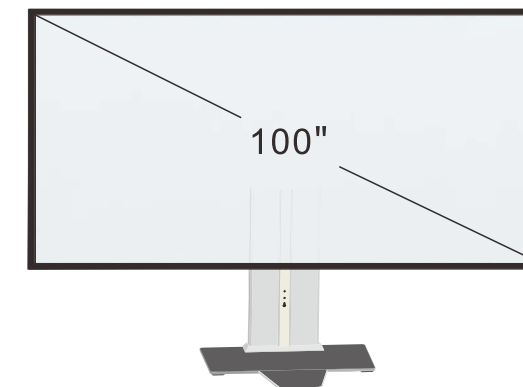

16:9 • desktop / floor-stand regular screen
• with powered height adjustment mechanism
桌上款/落地款普通幕(电动升降)

Item no.:
•SAW1610

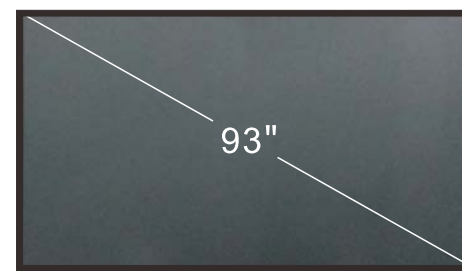

16:10 • ambient-light rejecting screen
• wall-mounted
• height adjustable
壁挂抗光幕(可升降)

Item no.:
•SAW1609

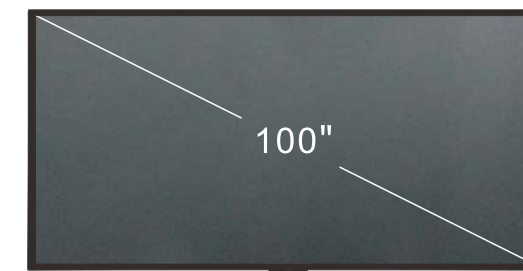

16:9 • ambient-light rejecting screen
• wall-mounted
• height adjustable
壁挂抗光幕(可升降)

Item no.:
•SAD1610 (desktop)
•SAF1610 (floor-stand)



16:10 • desktop / floor-stand ambient-light rejecting screen
• with powered height adjustment mechanism
桌上款/落地款抗光幕(电动升降)

Item no.:
•SAD1609 (desktop)
•SAF1609 (floor-stand)



16:9 • desktop / floor-stand ambient-light rejecting screen
• with powered height adjustment mechanism
桌上款/落地款抗光幕(电动升降)



Item no.:
•SRW1610

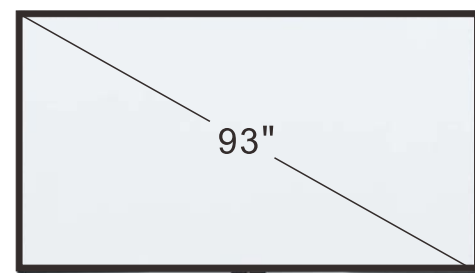

16:10 • fixed frame regular projection screen
• wall-mounted
• height adjustable
壁挂普通画框幕(可升降)

Item no.:
•SRW1609

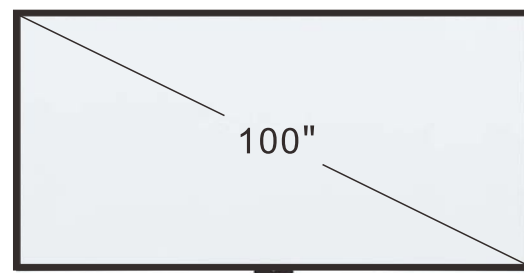

16:9 • fixed frame regular projection screen
• wall-mounted
• height adjustable
壁挂普通画框幕(可升降)

PROJECTION SCREEN

Specifications / 幕布规格表

Specifications 幕布规格表	Regular Projection Screen 普通投影幕			
Model no.	SRW1610	SRW1609	SRD1610	SRD1609
Style	Wall-mounted 壁挂式	Wall-mounted 壁挂式	Desktop 桌上款	Desktop 桌上款
Aspect ratio	16:10	16:9	16:10	16:9
Screen size	93"	100"	93"	100"
Height adjustable mechanism	Manual	Manual	Electrical	Electrical
Dimension(screen, excluding stand)	2017×1274×27mm 79.4"×50.2"×1.1"	2237×1274×27mm 88.1"×50.2"×1.1"	2017×1682×27mm 79.4"×66.2"×1.1"	2237×1682×27mm 88.1"×66.2"×1.1"
Weight(screen, including stand)	7.5kg/16.5pound	9kg/19.8pound	22.5kg/49.6pound	23.5kg/51.8pound
Dimension (whole package)	Carton #1 1310x740x100mm 51.6"x29.1"x3.9"	Carton #1 1310x740x100mm 51.6"x29.1"x3.9"	Carton #1 1310x740x125mm 51.6"x29.1"x4.9"	Carton #1 1310x740x125mm 51.6"x29.1"x4.9"
	Carton #2 1500x110x110mm 59"x4.3"x4.3"	Carton #2 1500x110x110mm 59"x4.3"x4.3"	Carton #2 1500x110x110mm 59"x4.3"x4.3"	Carton #2 1500x110x110mm 59"x4.3"x4.3"
Weight (whole package)	Carton #1 18kg 39.7pound	Carton #1 19.5kg 43pound	Carton #1 33kg 72.8pound	Carton #1 34kg 75pound
	Carton #2 2.5kg 5.5pound	Carton #2 3kg 6.6pound	Carton #2 2.5kg 5.5pound	Carton #2 3kg 6.6pound

Specifications 幕布规格表	Ambient-light Rejecting Projection Screen 抗光投影幕			
Model no.	SAW1610	SAW1609	SAD1610	SAD1609
Style	Wall-mounted 壁挂式	Wall-mounted 壁挂式	Desktop 桌上款	Desktop 桌上款
Aspect ratio	16:10	16:9	16:10	16:9
Screen size	93"	100"	93"	100"
Height adjustable mechanism	Manual	Manual	Electrical	Electrical
Dimension(screen, excluding stand)	2017×1274×27mm 79.4"×50.2"×1.1"	2237×1274×27mm 88.1"×50.2"×1.1"	2017×1682×27mm 79.4"×66.2"×1.1"	2237×1682×27mm 88.1"×66.2"×1.1"
Weight(screen, including stand)	7.5kg/16.5pound	9kg/19.8pound	22.5kg/49.6pound	22.5kg/51.8pound
Dimension (whole package)	Carton #1 1310x740x100mm 51.6"x29.1"x3.9"	Carton #1 1310x740x100mm 51.6"x29.1"x3.9"	Carton #1 1310x740x125mm 51.6"x29.1"x4.9"	Carton #1 1310x740x125mm 51.6"x29.1"x4.9"
	Carton #2 1500x110x110mm 58.5" x 3.7" x 3.7"	Carton #2 1500x110x110mm 58.5" x 3.7" x 3.7"	Carton #2 1500x110x110mm 58.5" x 3.7" x 3.7"	Carton #2 1500x110x110mm 58.5" x 3.7" x 3.7"
Weight (whole package)	Carton #1 18kg 39.7pound	Carton #1 19.5kg 43pound	Carton #1 33kg 72.8pound	Carton #1 34kg 75pound
	Carton #2 2.5kg 5.5pound	Carton #2 3kg 6.6pound	Carton #2 2.5kg 5.5pound	Carton #2 3kg 6.6pound

SUBWOOFER / 重低音

SUBWOOFER



AEP-397

Specifications / 规格表

Model No. 型号	AEP-397AW
Voice coil imp 额定阻抗	4Ω
Input power 输入功率	40W
Dimension(whole package) 尺寸	280×265×240mm/11"×10.4"×9.4"
Weight (whole package) 重量	2.4kg / 5.3pound

Optical Engine for UST projector

超短焦投影机光机系列

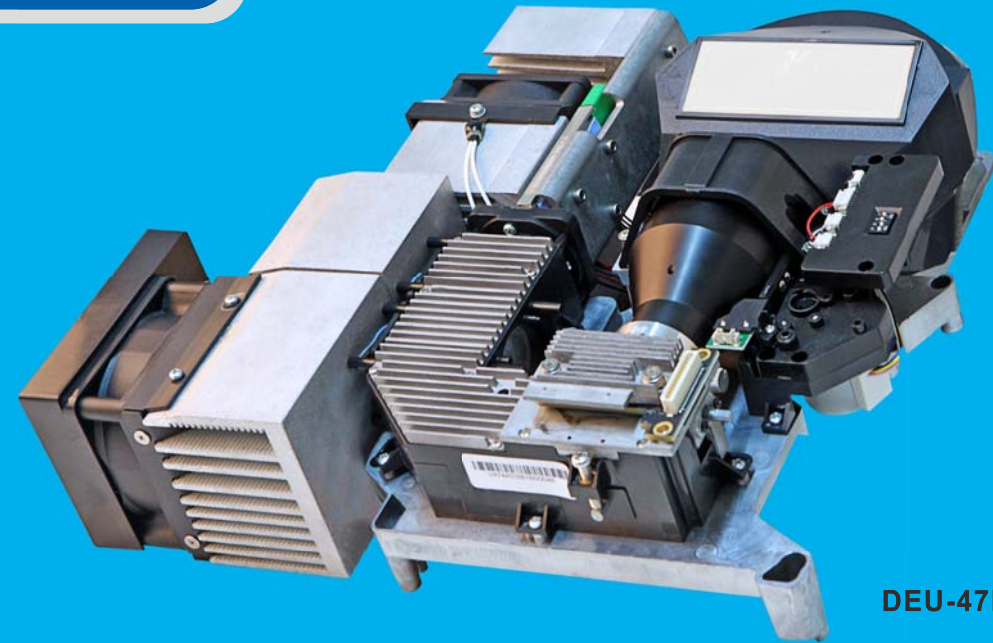

DEU-47FHD4

Philips HLD (High Lumen Density) LED inside
采用飞利浦最新高亮度LED光源

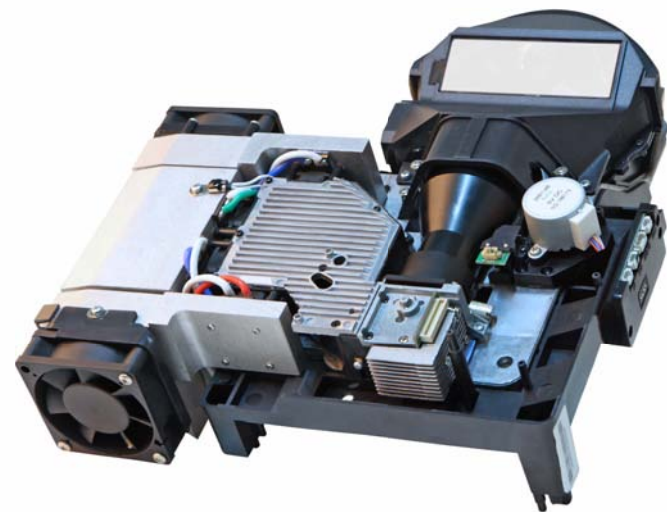

DEU-45WXGA4

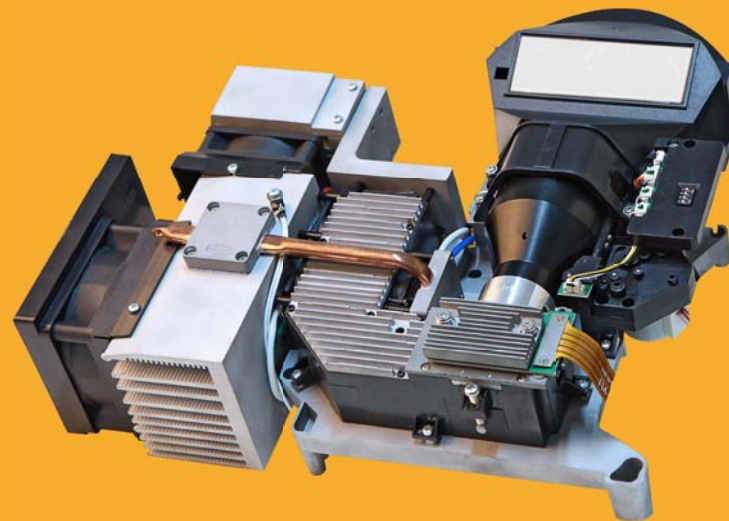

DEU-47FHD3
DEU-47FHD5

Specifications / 规格表

Model no. Spec. 规格	DEU-45WXGA4	DEU-47FHD3	DEU-47FHD4	DEU-47FHD5
Imaging tech. 影像技术	DLP (0.45" DMD)	DLP (0.47" DMD)	DLP (0.47" DMD)	DLP (0.47" DMD)
Native resolution (pixels) 原生解析度	1280 X 800	1920 X 1080	1920 X 1080	3840 X 2160
Aspect ratio 影像比例	16:10	16:9	16:9	16:9
Light Source 光源	LED×4 (R/G/B/B1)	LED×4 (R/G/B/B1)	LED×2 (R/B), HLD×1(G)	LED×4 (R/G/B/B1)
LED life (hours) LED寿命(小时)	30000	30000	30000	30000
Brightness (light source) 光源亮度	3600LM, 4200LM	3600LM, 4200LM	6000LM, 7200LM	3600LM, 4200LM
Luminous efficiency 光效	25%	25%	25%	25%
Throw ratio 投射比	0.2:1	0.2:1	0.2:1	0.2:1
Projection image size (distance) 投影距离	60"~180"	70"~180"	70"~180"	70"~180"
Contrast ratio (non-dynamic) 对比度(非动态)	>600:1	>600:1	>600:1	>600:1
Uniformity 均匀度	85%	85%	85%	85%
Focusing 调焦方式	Electric 电动	Electric 电动	Electric 电动	Electric 电动
LED heat sink LED散热片	Yes	Yes	Yes	Yes
Dimension 光机尺寸	260.6×314×93.7mm 10.3×12.4×3.7(inch)	305.8×217.4×101.9mm 12×8.6×4(inch)	265×253×134mm 10.4×9.9×5.3(inch)	305.8×217.4×101.9mm 12×8.6×4(inch)