

Datasheet

Multi-Color General-Purpose or Audible Indicators



Standard Audible



Sealed Audible



Omni-Directional Sealed Audible

- Rugged, cost-effective, and easy-to-install multi-segment indicators
- Illuminated segments provide easy-to-see operator guidance and indication of equipment status
- Up to 7 stacked colors available
- Available in black or light gray housing
- Audible models available with standard, sealed, or omni-directional audible element
- Compact devices are completely self-contained - no controller needed
- 18 to 30 V dc or 24 V ac operation
- No assembly required

Non-Audible Models

Model ¹	# of LED Colors	LED Function ²	Connection ³	Inputs
TL50RQ	1	Red	Integral 4-pin M12/Euro-style male quick disconnect (QD)	Bimodal (NPN or PNP)
TL50GRQ	2	Green, Red		
TL50GYRQ	3	Green, Yellow, Red	Integral 5-pin M12/Euro-style male quick disconnect (QD)	
TL50BGYRQ	4	Blue, Green, Yellow, Red		
TL50WBGYRQ	5	White, Blue, Green, Yellow, Red	Integral 8-pin M12/Euro-style male quick disconnect (QD)	



NOTE: Audible models are listed on the next page. For additional models and colors, visit Banner Engineering website at www.bannerengineering.com.

¹ Models with black housing are listed. For gray housing, add suffix C at the end of the model number (cabled models) or before the Q (QD models), for example, TL50RAC or TL50RACQ.

² The first color listed is the bottom color, going up in successive order. Contact the factory for other colors and color combinations

³ Integral QD models only are listed; mating cordset required (see [Cordsets](#) on page 5).

- For 150 mm (5.9 in) PVC pigtail with QD, replace Q with QP in the model number, for example, TL50RAQP.
- For 2 m (6.5 ft) cable, omit suffix Q from the model number, for example, TL50RA.



Audible Models

Standard Audible Models ⁴			# of LED Colors	LED Function ⁵	Connection ⁶	Inputs
TL50RAQ			1	Red	4-pin Euro integral QD connector	Bimodal (NPN or PNP)
TL50GRAQ			2	Green, Red		
TL50GYRAQ			3	Green, Yellow, Red	5-pin Euro integral QD connector	
TL50BGYRAQ			4	Blue, Green, Yellow, Red	8-pin Euro integral QD connector	
TL50WBGYRAQ			5	White, Blue, Green, Yellow, Red	8-pin Euro integral QD connector	

Sealed Audible Models ⁴			# of LED Colors	LED Function ⁵	Connection ⁶	Inputs
Continuous	Pulsed at 1.6 Hz	Staccato				
TL50RALSQ	TL50RALS3Q	TL50RALS4Q	1	Red	4-pin Euro integral QD connector	Bimodal (NPN or PNP)
TL50GRALSQ	TL50GRALS3Q	TL50GRALS4Q	2	Green, Red		
TL50GYRALSQ	TL50GYRALS3Q	TL50GYRALS4Q	3	Green, Yellow, Red	5-pin Euro integral QD connector	
TL50BGRALSQ	TL50BGRALS3Q	TL50BGRALS4Q	4	Blue, Green, Yellow, Red	8-pin Euro integral QD connector	
TL50WBGYRALSQ	TL50WBGYRALS3Q	TL50WBGYRALS4Q	5	White, Blue, Green, Yellow, Red	8-pin Euro integral QD connector	

Omni-Directional ⁷ Sealed Audible Models (99 dB max) ⁴			# of LED Colors	LED Function ⁵	Connection ⁶	Inputs
Continuous	Pulsed at 1.6 Hz	Staccato				
TL50RAOSQ	TL50RAOS3Q	TL50RAOS4Q	1	Red	4-pin Euro integral QD connector	Bimodal (NPN or PNP)
TL50GRAOSQ	TL50GRAOS3Q	TL50GRAOS4Q	2	Green, Red		
TL50GYRAOSQ	TL50GYRAOS3Q	TL50GYRAOS4Q	3	Green, Yellow, Red	5-pin Euro integral QD connector	
TL50BGYRAOSQ	TL50BGYRAOS3Q	TL50BGYRAOS4Q	4	Blue, Green, Yellow, Red	8-pin Euro integral QD connector	
TL50WBGYRAOSQ	TL50WBGYRAOS3Q	TL50WBGYRAOS4Q	5	White, Blue, Green, Yellow, Red	8-pin Euro integral QD connector	

Omni-Directional ⁷ Sealed Audible Models with Intensity Adjustment (95 dB max) ⁴			# of LED Colors	LED Function ⁵	Connection ⁶	Inputs
Continuous	Pulsed at 1.6 Hz	Staccato				
TL50RAOSIQ	TL50RAOS3IQ	TL50RAOS4IQ	1	Red	4-pin Euro integral QD connector	Bimodal (NPN or PNP)
TL50GRAOSIQ	TL50GRAOS3IQ	TL50GRAOS4IQ	2	Green, Red		
TL50GYRAOSIQ	TL50GYRAOS3IQ	TL50GYRAOS4IQ	3	Green, Yellow, Red	5-pin Euro integral QD connector	
TL50BGYRAOSIQ	TL50BGYRAOS3IQ	TL50BGYRAOS4IQ	4	Blue, Green, Yellow, Red	8-pin Euro integral QD connector	
TL50WBGYRAOSIQ	TL50WBGYRAOS3IQ	TL50WBGYRAOS4IQ	5	White, Blue, Green, Yellow, Red	8-pin Euro integral QD connector	

⁴ Models with black housing are listed. For gray housing, add suffix C at the end of the model number (cabled models) or before the Q (QD models), for example, TL50RAC or TL50RACQ.

⁵ The first color listed is the bottom color, going up in successive order. Contact the factory for other colors and color combinations.

⁶ Integral QD models only are listed; mating cordset required (see [Cordsets](#) on page 5).

- For 150 mm (5.9 in) PVC pigtail with QD, replace Q with QP in the model number, for example, TL50RAQP.

- For 2 m (6.5 ft) cable, omit suffix Q from the model number, for example, TL50RA.

⁷ Sound exits at 45°.

Specifications

Supply Voltage and Current

18–30 V dc or 21–27 V ac
 Models with more than 5 segments: 12–30 V dc or 21–26 V ac (both lights and audible alarms are counted as segments)
 Indicators—maximum current per LED color: 45 mA
 Standard Audible Alarm: 25 mA maximum current
 Sealed Audible Alarm: 35 mA maximum current
 Omni-Directional Sealed Audible Alarm: 45 mA maximum current

Supply Protection Circuitry

Protected against reverse polarity and transient voltages

Input Response Time

Indicator On/Off: 10 ms (maximum)

Audible Adjustment

Standard Audible Alarm: Unscrew the cover (up to 1.5 turns maximum) to adjust the audible intensity. (Do not exceed 1.5 turns or the cover may detach during operation.) For maximum intensity, rotate the center plug 180° counterclockwise to remove it.
 Sealed Audible Alarm and Omni-Directional Sealed Audible Alarm with Intensity Adjustment: Rotate the front cover until the desired intensity is reached.
 Omni-Directional Sealed Audible Alarm: No adjustment.

Operating Conditions

Non-Audible: -40 °C to +50 °C (-40 °F to +122 °F)
 Standard and Sealed Audible: -20 °C to +50 °C (-4 °F to +122 °F)
 95% at +50 °C maximum relative humidity (non-condensing)

Environmental Rating

Non-Audible and Sealed Audible: IEC IP67
 Standard Audible: IEC IP50

Vibration and Mechanical Shock

All models meet Mil Std. 202F requirements. Method 201A (vibration: 10 to 60 Hz max., double amplitude 0.06", maximum acceleration 10G). Also meets IEC 947-5-2 requirements: 30G 11 ms duration, half sine wave.

Certifications



Models with more than five segments: pending

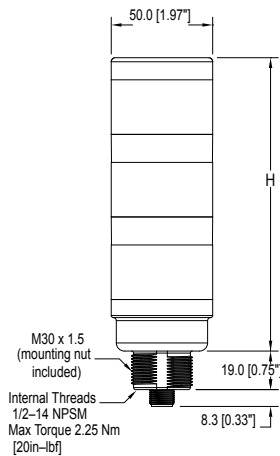

Audible Alarm

Standard Audible Alarm: 2.7 kHz ± 500 Hz oscillation frequency; maximum intensity 92 dB at 1 m (3.3 ft) (typical)
 Sealed Audible Alarm: 2.9 kHz ± 250 Hz oscillation frequency; maximum intensity 94 dB at 1 m (3.3 ft) (typical)
 Omni-Directional Sealed Audible Alarm: 2.1 kHz ± 250 Hz oscillation frequency; maximum intensity 99 dB at 1 m (3.3 ft) (typical)
 Omni-Directional Sealed Audible Alarm with Intensity Adjustment: 2.1 kHz ± 250 Hz oscillation frequency; maximum intensity 95 dB at 1 m (3.3 ft) (typical)

Indicators

LEDs are independently selected; 1 to 7 colors depending on model

Construction

Bases and Covers: ABS
 Light Segment: Polycarbonate

Connections

Integral 4-pin, 5-pin, or 8-pin M12/Euro-style QD, 150 mm (6 in) PVC pigtail with QD, or 2 m (6.5 ft) integral cable, depending on model

Required Overcurrent Protection



WARNING: Electrical connections must be made by qualified personnel in accordance with local and national electrical codes and regulations.

Overcurrent protection is required to be provided by end product application per the supplied table.

Overcurrent protection may be provided with external fusing or via Current Limiting, Class 2 Power Supply.

Supply wiring leads < 24 AWG shall not be spliced.

For additional product support, go to <http://www.bannerengineering.com>.

Supply Wiring (AWG)	Required Overcurrent Protection (Amps)
20	5.0
22	3.0
24	2.0
26	1.0
28	0.8
30	0.5

# of Colors	Tower Height (H)			
	Non-Audible	Standard Audible*	Sealed Audible	Omni-Directional Sealed Audible
1	61.2 mm (2.4 in)	92.0 mm (3.6 in)	115.1 mm (4.5 in)	129.1 mm (5.1 in)
2	101.9 mm (4.0 in)	132.7 mm (5.2 in)	155.8 mm (6.1 in)	169.8 mm (6.7 in)
3	142.6 mm (5.6 in)	173.4 mm (6.8 in)	196.5 mm (7.7 in)	210.5 mm (8.3 in)
4	183.3 mm (7.2 in)	214.1 mm (8.4 in)	237.2 mm (9.3 in)	251.2 mm (9.9 in)
5	224.0 mm (8.8 in)	254.8 mm (10.0 in)	277.9 mm (10.9 in)	291.1 mm (11.5 in)
6	264.7 mm (10.4 in)	298.5 mm (11.8 in)	318.6 mm (12.5 in)	332.6 mm (13.1 in)
7	305.4 mm (12.0 in)	–	–	–

* Tower height (H) with top unscrewed approximately 3.5 mm (0.18 in) to allow sound to escape

Wiring Diagram – 4-Pin Models

Sourcing (PNP) Input

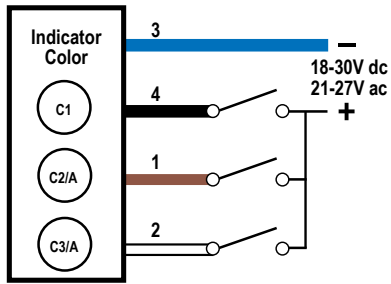

Sinking (NPN) Input

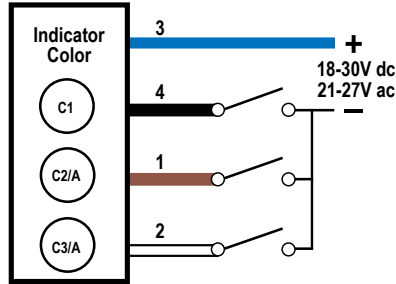

Key:

- 1 = Brown
- 2 = White
- 3 = Blue
- 4 = Black

- C1 = Color 1
- C2 = Color 2
- C3 = Color 3
- A = Audible

Pins 1 and 2 can activate the corresponding color or the audible function, if available.

Wiring Diagram – 5-Pin Models

Sourcing (PNP) Input

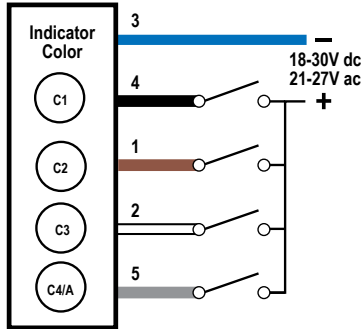

Sinking (NPN) Input

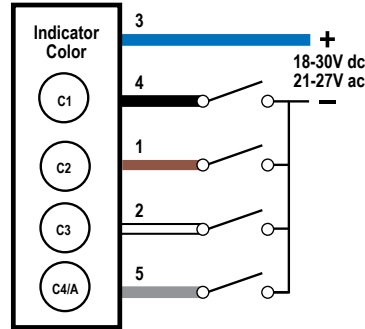

Key:

- 1 = Brown
- 2 = White
- 3 = Blue
- 4 = Black
- 5 = Gray

- C1 = Color 1
- C2 = Color 2
- C3 = Color 3
- C4 = Color 4
- A = Audible

Pin 5 can activate the corresponding color or the audible function, if available.

Wiring Diagram – 8-Pin Models

Sourcing (PNP) Input

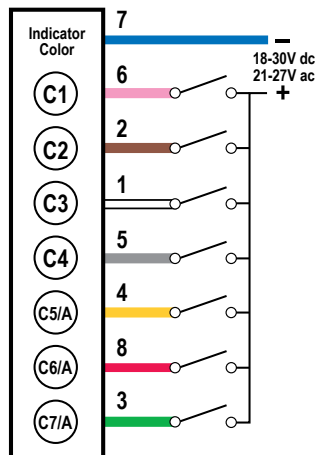

Sinking (NPN) Input

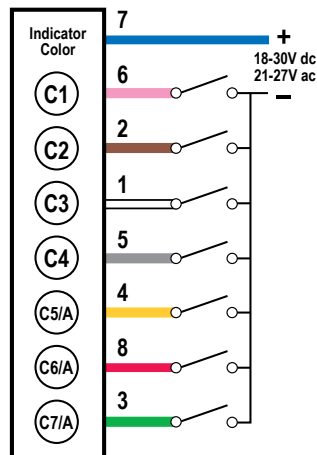

Key:

- 1 = White
- 2 = Brown
- 3 = Green
- 4 = Yellow
- 5 = Gray
- 6 = Pink
- 7 = Blue
- 8 = Red

- C1 = Color 1
- C2 = Color 2
- C3 = Color 3
- C4 = Color 4
- C5 = Color 5
- C6 = Color 6
- C7 = Color 7
- A = Audible

Pins 3, 4 and 8 can activate the corresponding color or the audible function, if available.

Accessories

Cordsets

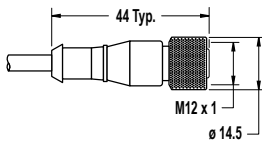
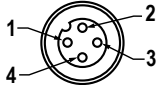
4-Pin Threaded M12/Euro-Style Cordsets				
Model	Length	Style	Dimensions	Pinout (Female)
MQDC-406	1.83 m (6 ft)	Straight		 <p>1 = Brown 2 = White 3 = Blue 4 = Black</p>
MQDC-415	4.57 m (15 ft)			
MQDC-430	9.14 m (30 ft)			
MQDC-450	15.2 m (50 ft)			

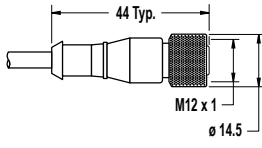
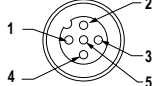
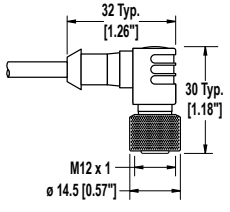
5-Pin Threaded M12/Euro-Style Cordsets—Single Ended				
Model	Length	Style	Dimensions	Pinout (Female)
MQDC1-501.5	0.50 m (1.5 ft)	Straight		 <p>1 = Brown 2 = White 3 = Blue 4 = Black 5 = Gray</p>
MQDC1-506	1.83 m (6 ft)			
MQDC1-515	4.57 m (15 ft)			
MQDC1-530	9.14 m (30 ft)			
MQDC1-506RA	1.83 m (6 ft)	Right-Angle		
MQDC1-515RA	4.57 m (15 ft)			
MQDC1-530RA	9.14 m (30 ft)			

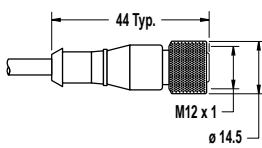
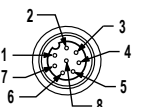
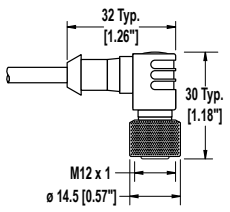
8-Pin Threaded M12/Euro-Style Cordsets with Open-Shield				
Model	Length	Style	Dimensions	Pinout (Female)
MQDC2S-806	1.83 m (6 ft)	Straight		 <p>1 = White 2 = Brown 3 = Green 4 = Yellow 5 = Gray 6 = Pink 7 = Blue 8 = Red</p>
MQDC2S-815	4.57 m (15 ft)			
MQDC2S-830	9.14 m (30 ft)			
MQDC2S-850	15.2 m (50 ft)			
MQDC2S-806RA	1.83 m (6 ft)	Right-Angle		
MQDC2S-815RA	4.57 m (15 ft)			
MQDC2S-830RA	9.14 m (30 ft)			
MQDC2S-850RA	15.2 m (50 ft)			

Mounting Brackets

SMB30A

- Right-angle bracket with curved slot for versatile orientation
- Clearance for M6 (¼ in) hardware
- Mounting hole for 30 mm sensor
- 12-ga. stainless steel

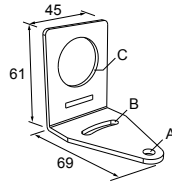

Hole center spacing: A to B=40
Hole size: A=∅ 6.3, B= 27.1 x 6.3, C=∅ 30.5

SMB30FA

- Swivel bracket with tilt and pan movement for precise adjustment
- Mounting hole for 30 mm sensor
- 12-ga. 304 stainless steel
- Easy sensor mounting to extrude rail T-slot
- Metric and inch size bolt available

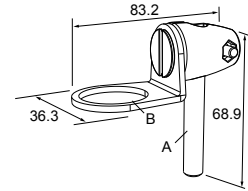

Bolt thread: SMB30FA, A= 3/8 - 16 x 2 in; SMB30FAM10, A= M10 - 1.5 x 50
Hole size: B= ∅ 30.1

SMB30MM

- 12-ga. stainless steel bracket with curved mounting slots for versatile orientation
- Clearance for M6 (¼ in) hardware
- Mounting hole for 30 mm sensor

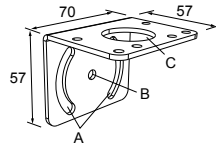

Hole center spacing: A = 51, A to B = 25.4
Hole size: A = 42.6 x 7, B = ∅ 6.4, C = ∅ 30.1

SMBAMS30P

- Flat SMBAMS series bracket
- 30 mm hole for mounting sensors
- Articulation slots for 90° + rotation
- 12-ga. 300 series stainless steel

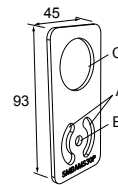

Hole center spacing: A=26.0, A to B=13.0
Hole size: A=26.8 x 7.0, B=∅ 6.5, C=∅ 31.0

SMBAMS30RA

- Right-angle SMBAMS series bracket
- 30 mm hole for mounting sensors
- Articulation slots for 90° + rotation
- 12-ga. (2.6 mm) cold-rolled steel

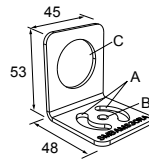

Hole center spacing: A=26.0, A to B=13.0
Hole size: A=26.8 x 7.0, B=∅ 6.5, C=∅ 31.0

SMB30SC

- Swivel bracket with 30 mm mounting hole for sensor
- Black reinforced thermoplastic polyester
- Stainless steel mounting and swivel locking hardware included

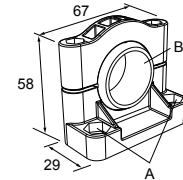



Hole center spacing: A=∅ 50.8
Hole size: A=∅ 7.0, B=∅ 30.0

All measurements are listed in millimeters (inches), unless noted otherwise.

LMB Sealed Right-Angle Bracket

Model	Description	Construction	
LMB30RA	Direct-Mount Models: Bracket kit with base, 30 mm adapter, set screw, fasteners, o-rings, and gaskets	Black polycarbonate	
LMB30RAC		Gray polycarbonate	
LMBE12RA	Pipe-Mount Models: Bracket kit with base, ½-14 pipe adapter, set screw, fasteners, o-rings, and gaskets. For use with stand-off pipe (listed and sold separately)	Black polycarbonate	
LMBE12RAC		Gray polycarbonate	

Elevated Mount System

Model			Features	Components
SA-M30TE12 - Black Acetal			<ul style="list-style-type: none"> Streamlined black acetal or white UHMW stand-off pipe adapter/cover Connects between 30 mm light base and ½ in. NPSM/DN15 pipe Mounting hardware included 	
SA-M30TE12C - White UHMW				
Polished 304 Stainless Steel	Black Anodized Aluminum	Clear Anodized Aluminum	<ul style="list-style-type: none"> Elevated-use stand-off pipe (½ in. NPSM/DN15) Polished 304 stainless steel, black anodized aluminum, or clear anodized aluminum surface ½ in. NPT thread at both ends Compatible with most industrial environments 	
SOP-E12-150SS 150 mm (6 in) long	SOP-E12-150A 150 mm (6 in) long	SOP-E12-150AC 150 mm (6 in) long		
SOP-E12-300SS 300 mm (12 in) long	SOP-E12-300A 300 mm (12 in) long	SOP-E12-300AC 300 mm (12 in) long		
SOP-E12-900SS 900 mm (36 in) long	SOP-E12-900A 900 mm (36 in) long	SOP-E12-900AC 900 mm (36 in) long		
SA-E12M30 - Black Acetal			<ul style="list-style-type: none"> Streamlined black acetal or white UHMW mounting base adapter/cover Connects between ½ in. NPSM/DN15 pipe and 30 mm (1-3/16 in) drilled hole Mounting hardware included 	
SA-E12M30C - White UHMW				

Pipe Mounting Flange

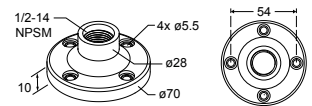
Pipe Mounting Flange			
Model	Features	Construction	
SA-F12	<ul style="list-style-type: none"> For use elevated stand-off pipes (½ in. NPSM/DN15) M5 mounting hardware and nitrile gasket included 	Die-cast zinc base with black paint	

Banner Engineering Corp Limited Warranty

Banner Engineering Corp. warrants its products to be free from defects in material and workmanship for one year following the date of shipment. Banner Engineering Corp. will repair or replace, free of charge, any product of its manufacture which, at the time it is returned to the factory, is found to have been defective during the warranty period. This warranty does not cover damage or liability for misuse, abuse, or the improper application or installation of the Banner product.

THIS LIMITED WARRANTY IS EXCLUSIVE AND IN LIEU OF ALL OTHER WARRANTIES WHETHER EXPRESS OR IMPLIED (INCLUDING, WITHOUT LIMITATION, ANY WARRANTY OF MERCHANTABILITY OR FITNESS FOR A PARTICULAR PURPOSE), AND WHETHER ARISING UNDER COURSE OF PERFORMANCE, COURSE OF DEALING OR TRADE USAGE.

This Warranty is exclusive and limited to repair or, at the discretion of Banner Engineering Corp., replacement. IN NO EVENT SHALL BANNER ENGINEERING CORP. BE LIABLE TO BUYER OR ANY OTHER PERSON OR ENTITY FOR ANY EXTRA COSTS, EXPENSES, LOSSES, LOSS OF PROFITS, OR ANY INCIDENTAL, CONSEQUENTIAL OR SPECIAL DAMAGES RESULTING FROM ANY PRODUCT DEFECT OR FROM THE USE OR INABILITY TO USE THE PRODUCT, WHETHER ARISING IN CONTRACT OR WARRANTY, STATUTE, TORT, STRICT LIABILITY, NEGLIGENCE, OR OTHERWISE.

Banner Engineering Corp. reserves the right to change, modify or improve the design of the product without assuming any obligations or liabilities relating to any product previously manufactured by Banner Engineering Corp.