

EZ-LIGHT® TL50BLZ Beacon Universal AC Voltage Tower Light



Datasheet

Multi-Color General-Purpose or Audible Indicators



The EZ-LIGHT® TL50 Beacon Tower Light is a cross between the TL50 tower light and the K50 beacon. This compact design is extremely intense and can even be used in areas with high levels of ambient light.

- Rugged, cost-effective, and easy-to-install multi-segment indicators
- Illuminated segments provide easy-to-see operator guidance and indication of equipment status
- Displays up to 5 colors
- Available in black or light gray housing
- Audible models available with standard, sealed, or omni-directional audible element
- Continuous, pulsed, and staccato tones available
- 85 to 264 V ac operation
- No assembly required

Non-Audible Models

Model ¹	# of LED Colors	LED Function ²	Connection ³	Inputs
TL50BLZR	1	Red	4-wire PVC cable	85-264 V ac
TL50BLZGR	2	Green, Red		
TL50BLZGYR	3	Green, Yellow, Red		
TL50BLZBGYR	4	Blue, Green, Yellow, Red	5-wire PVC cable	
TL50BLZWBGYR	5	White, Blue, Green, Yellow, Red	6-wire PVC cable	



NOTE: Audible models are listed on the next page. For additional models and colors, visit Banner Engineering website at www.bannerengineering.com.

¹ Cabled black models only are listed. For gray housing, add suffix C at the end of the model number (cabled models) or before the QP (pigtail models), for example, TL50BLZRC or TL50BLZRCQP.
² The first color listed is the bottom color, going up in successive order. Contact the factory for other colors and color combinations.
³ Five color options are only available in non-audible cabled models. Four color options are only available in audible cabled models. Cabled models only are listed; mating cordset required for pigtail models (see [Cordsets](#) on page 4). To order 150 mm (5.9 in) PVC pigtail with QD models, add QP to the end of the model number, for example, TL50BLZRQP.



Audible Models

Standard Audible Models ⁴			# of LED Colors	LED Function ⁵	Connection ⁶	Inputs
TL50BLZRA			1	Red	4-wire PVC cable	85-264 V ac
TL50BLZGRA			2	Green, Red		
TL50BLZGYRA			3	Green, Yellow, Red	5-wire PVC cable	
TL50BLZBGYRA			4	Blue, Green, Yellow, Red	6-wire PVC cable	

Sealed Audible Models ⁴			# of LED Colors	LED Function ⁵	Connection ⁶	Inputs
Continuous	Pulsed at 1.6 Hz	Staccato				
TL50BLZRALS	TL50BLZRALS3	TL50BLZRALS4	1	Red	4-wire PVC cable	85-264 V ac
TL50BLZGRALS	TL50BLZGRALS3	TL50BLZGRALS4	2	Green, Red		
TL50BLZGYRALS	TL50BLZGYRALS3	TL50BLZGYRALS4	3	Green, Yellow, Red	5-wire PVC cable	
TL50BLZBGYRALS	TL50BLZBGYRALS3	TL50BLZBGYRALS4	4	Blue, Green, Yellow, Red	6-wire PVC cable	

Omni-Directional Sealed Audible Models ⁴			# of LED Colors	LED Function ⁵	Connection ⁶	Inputs
Continuous	Pulsed at 1.6 Hz	Staccato				
TL50BLZRAOS	TL50BLZRAOS3	TL50BLZRAOS4	1	Red	4-wire PVC cable	85-264 V ac
TL50BLZGRAOS	TL50BLZGRAOS3	TL50BLZGRAOS4	2	Green, Red		
TL50BLZGYRAOS	TL50BLZGYRAOS3	TL50BLZGYRAOS4	3	Green, Yellow, Red	5-wire PVC cable	
TL50BLZBGYRAOS	TL50BLZBGYRAOS3	TL50BLZBGYRAOS4	4	Blue, Green, Yellow, Red	6-wire PVC cable	

Omni-Directional Sealed Audible Models with Intensity Adjustment ⁴			# of LED Colors	LED Function ⁵	Connection ⁶	Inputs
Continuous	Pulsed at 1.6 Hz	Staccato				
TL50BLZRAOSI	TL50BLZRAOS3I	TL50BLZRAOS4I	1	Red	4-wire PVC cable	85-264 V ac
TL50BLZGRAOSI	TL50BLZGRAOS3I	TL50BLZGRAOS4I	2	Green, Red		
TL50BLZGYRAOSI	TL50BLZGYRAOS3I	TL50BLZGYRAOS4I	3	Green, Yellow, Red	5-wire PVC cable	
TL50BLZBGYRAOSI	TL50BLZBGYRAOS3I	TL50BLZBGYRAOS4I	4	Blue, Green, Yellow, Red	6-wire PVC cable	

Specifications

Supply Voltage and Current

85–264 V ac; 50 or 60 Hz

Indicators—maximum current per LED color:

70 mA at 85 V ac

55 mA at 120 V ac

35 mA at 240 V ac

30 mA at 264 V ac

Standard Audible Alarm: 25 mA maximum current

Sealed Audible Alarm: 30 mA maximum current

Omni-Directional Sealed Audible Alarm: 45 mA maximum current

Supply Protection Circuitry

Protected against reverse polarity and transient voltages

Indicators

LEDs are independently selected; 1 to 5 colors (Green, Red, Yellow, Blue, White) depending on model

Input Response Time

Indicator On/Off: 500 ms (maximum)

Construction

Bases and Covers: ABS

Light Segment: Polycarbonate

⁴ Cabled black models only are listed. For gray housing, add suffix C at the end of the model number (cabled models) or before the QP (pigtail models), for example, TL50BLZRC or TL50BLZRCQP.

⁵ The first color listed is the bottom color, going up in successive order. Contact the factory for other colors and color combinations. Five color options are only available in non-audible cabled models. Four color options are only available in audible cabled models.

⁶ Cabled models only are listed; mating cordset required for pigtail models (see [Cordsets](#) on page 4). To order the 150 mm (5.9 in) PVC pigtail with QD models, add QP to the end of the model number, for example, TL50BLZRQP.

Audible Adjustment

Standard Audible Alarm: Unscrew the cover (up to 1.5 turns maximum) to adjust the audible intensity. (Do not exceed 1.5 turns or the cover may detach during operation.) For maximum intensity, rotate the center plug 180° counterclockwise to remove it.
 Sealed Audible Alarm and Omni-Directional Sealed Audible Alarm with Intensity Adjustment: Rotate the front cover until the desired intensity is reached.
 Omni-Directional Sealed Audible Alarm: No adjustment.

Leakage Current Immunity

500 µA
 Application Note: The use of relay output PLC is recommended since there is no leakage current. Solid state output PLCs often have leakage current above 1 mA and, therefore, turn the light on in the off state. To counteract the leakage current, a shunt resistor must be used. A resistor must be applied from the neutral wire of the device to the hot wire of each channel of the device.

Environmental Rating

Non-Audible and Sealed Audible: IEC IP67
 Standard Audible: IEC IP50

Operating Conditions

Non-Audible: -40 °C to +50 °C (-40 °F to +122 °F)
 Standard and Sealed Audible: -20 °C to +50 °C (-4 °F to +122 °F)
 95% at +50 °C maximum relative humidity (non-condensing)

Vibration and Mechanical Shock

All models meet Mil Std. 202F requirements. Method 201A (vibration: 10 to 60 Hz max., double amplitude 0.06", maximum acceleration 10G). Also meets IEC 947-5-2 requirements: 30G 11 ms duration, half sine wave.

Certifications



Audible Alarm

Standard Audible Alarm: 2.7 kHz ± 500 Hz oscillation frequency; maximum intensity 92 dB at 1 m (3.3 ft) (typical)
 Sealed Audible Alarm: 2.9 kHz ± 250 Hz oscillation frequency; maximum intensity 94 dB at 1 m (3.3 ft) (typical)
 Omni-Directional Sealed Audible Alarm: 2.1 kHz ± 250 Hz oscillation frequency; maximum intensity 99 dB at 1 m (3.3 ft) (typical)
 Omni-Directional Sealed Audible Alarm with Intensity Adjustment: 2.1 kHz ± 250 Hz oscillation frequency; maximum intensity 95 dB at 1 m (3.3 ft) (typical)

Connections

4-wire, 5-wire, or 6-wire 2 m (6.5 ft) integral cable; 4-pin or 5-pin 150 mm (6 in) PVC pigtail with OD, depending on model

Required Overcurrent Protection



WARNING: Electrical connections must be made by qualified personnel in accordance with local and national electrical codes and regulations.

Overcurrent protection is required to be provided by end product application per the supplied table.
 Overcurrent protection may be provided with external fusing or via Current Limiting, Class 2 Power Supply.
 Supply wiring leads < 24 AWG shall not be spliced.
 For additional product support, go to <http://www.bannerengineering.com>.

Supply Wiring (AWG)	Required Overcurrent Protection (Amps)
20	5.0
22	3.0
24	2.0
26	1.0
28	0.8
30	0.5

Dimensions

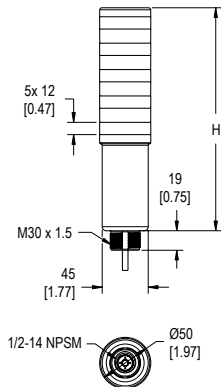

# of Colors	Tower Height (H)			
	Non-Audible	Standard Audible*	Sealed Audible	Omni-Directional Sealed Audible
1	115.2 mm (4.5 in)	146.1 mm (5.8 in)	169.2 mm (6.7 in)	183.2 mm (7.2 in)
2	141.0 mm (5.6 in)	171.9 mm (6.8 in)	195.0 mm (7.7 in)	209.0 mm (8.2 in)
3	166.8 mm (6.6 in)	197.7 mm (7.8 in)	220.8 mm (8.7 in)	234.8 mm (9.2 in)
4	192.6 mm (7.6 in)	223.5 mm (8.8 in)	246.6 mm (9.7 in)	260.6 mm (10.3 in)
5	218.4 mm (8.6 in)	-	-	-

* Tower height (H) with top unscrewed approximately 3.5 mm to allow sound to escape

Wiring Diagram

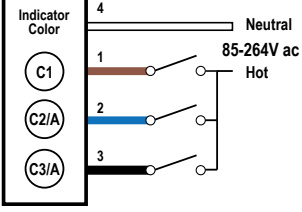
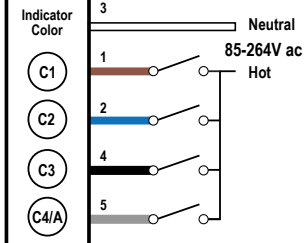
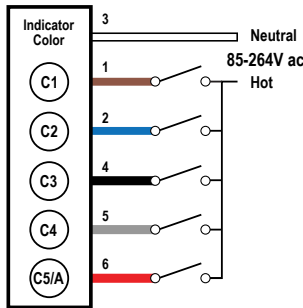
4-wire	5-wire	6-wire
 <p>Indicator Color</p> <p>4 Neutral</p> <p>1 85-264V ac Hot</p> <p>2</p> <p>3</p> <p>C1 = Color 1</p> <p>C2/A = Color 2</p> <p>C3/A = Color 3</p> <p>A = Audible</p> <p>1 = Brown</p> <p>2 = Blue</p> <p>3 = Black</p> <p>4 = White</p>	 <p>Indicator Color</p> <p>3 Neutral</p> <p>1 85-264V ac Hot</p> <p>2</p> <p>4</p> <p>5</p> <p>C1 = Color 1</p> <p>C2 = Color 2</p> <p>C3 = Color 3</p> <p>C4/A = Color 4</p> <p>C5/A = Color 5</p> <p>A = Audible</p> <p>1 = Brown</p> <p>2 = Blue</p> <p>3 = White</p> <p>4 = Black</p> <p>5 = Gray</p>	 <p>Indicator Color</p> <p>3 Neutral</p> <p>1 85-264V ac Hot</p> <p>2</p> <p>4</p> <p>5</p> <p>6</p> <p>C1 = Color 1</p> <p>C2 = Color 2</p> <p>C3 = Color 3</p> <p>C4 = Color 4</p> <p>C5/A = Color 5</p> <p>C6/A = Color 6</p> <p>A = Audible</p> <p>1 = Brown</p> <p>2 = Blue</p> <p>3 = White</p> <p>4 = Black</p> <p>5 = Gray</p> <p>6 = Red</p>

Accessories

Cordsets

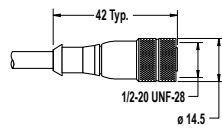
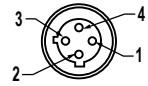
4-Pin Micro-Style Cordsets				
Model	Length	Style	Dimensions	Pinout (Female)
MQAC2-406	1.83 m (6 ft)	Straight		 <p>1 = Brown</p> <p>2 = Blue</p> <p>3 = Black</p> <p>4 = White</p>
MQAC2-415	4.57 m (15 ft)			
MQAC2-430	9.14 m (30 ft)			

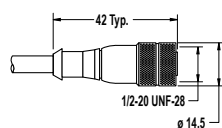
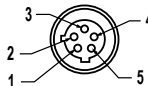
5-Pin Micro-Style Cordsets				
Model	Length	Style	Dimensions	Pinout
MQAC2-506	1.83 m (6 ft)	Straight		 <p>1 = Brown</p> <p>2 = Blue</p> <p>3 = White</p> <p>4 = Black</p> <p>5 = Gray</p>
MQAC2-515	4.57 m (15 ft)			
MQAC2-530	9.14 m (30 ft)			

Mounting Brackets

SMB30A

- Right-angle bracket with curved slot for versatile orientation
- Clearance for M6 (¼ in) hardware
- Mounting hole for 30 mm sensor
- 12-ga. stainless steel

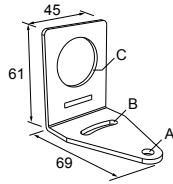

Hole center spacing: A to B=40
Hole size: A=ø 6.3, B= 27.1 x 6.3, C=ø 30.5

SMB30FA

- Swivel bracket with tilt and pan movement for precise adjustment
- Mounting hole for 30 mm sensor
- 12-ga. 304 stainless steel
- Easy sensor mounting to extrude rail T-slot
- Metric and inch size bolt available

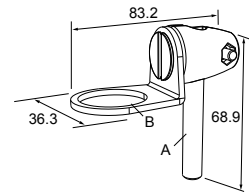

Bolt thread: SMB30FA, A= 3/8 - 16 x 2 in; SMB30FAM10, A= M10 - 1.5 x 50
Hole size: B= ø 30.1

SMB30MM

- 12-ga. stainless steel bracket with curved mounting slots for versatile orientation
- Clearance for M6 (¼ in) hardware
- Mounting hole for 30 mm sensor

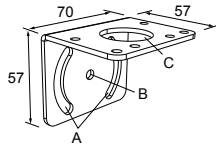

Hole center spacing: A = 51, A to B = 25.4
Hole size: A = 42.6 x 7, B = ø 6.4, C = ø 30.1

SMBAMS30P

- Flat SMBAMS series bracket
- 30 mm hole for mounting sensors
- Articulation slots for 90° + rotation
- 12-ga. 300 series stainless steel

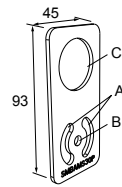

Hole center spacing: A=26.0, A to B=13.0
Hole size: A=26.8 x 7.0, B=ø 6.5, C=ø 31.0

SMBAMS30RA

- Right-angle SMBAMS series bracket
- 30 mm hole for mounting sensors
- Articulation slots for 90° + rotation
- 12-ga. (2.6 mm) cold-rolled steel

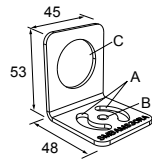

Hole center spacing: A=26.0, A to B=13.0
Hole size: A=26.8 x 7.0, B=ø 6.5, C=ø 31.0

SMB30SC

- Swivel bracket with 30 mm mounting hole for sensor
- Black reinforced thermoplastic polyester
- Stainless steel mounting and swivel locking hardware included

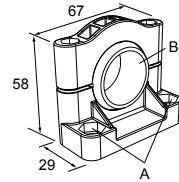



Hole center spacing: A=ø 50.8
Hole size: A=ø 7.0, B=ø 30.0

All measurements are listed in millimeters (inches), unless noted otherwise.

LMB Sealed Right-Angle Bracket

Model	Description	Construction	
LMB30RA	Direct-Mount Models: Bracket kit with base, 30 mm adapter, set screw, fasteners, o-rings, and gaskets	Black polycarbonate	
LMB30RAC		Gray polycarbonate	
LMBE12RA	Pipe-Mount Models: Bracket kit with base, ½-14 pipe adapter, set screw, fasteners, o-rings, and gaskets. For use with stand-off pipe (listed and sold separately)	Black polycarbonate	
LMBE12RAC		Gray polycarbonate	

Elevated Mount System

Model			Features	Components
SA-M30TE12 - Black Acetal			<ul style="list-style-type: none"> Streamlined black acetal or white UHMW stand-off pipe adapter/cover Connects between 30 mm light base and ½ in. NPSM/DN15 pipe Mounting hardware included 	
SA-M30TE12C - White UHMW				
Polished 304 Stainless Steel	Black Anodized Aluminum	Clear Anodized Aluminum	<ul style="list-style-type: none"> Elevated-use stand-off pipe (½ in. NPSM/DN15) Polished 304 stainless steel, black anodized aluminum, or clear anodized aluminum surface ½ in. NPT thread at both ends Compatible with most industrial environments 	
SOP-E12-150SS 150 mm (6 in) long	SOP-E12-150A 150 mm (6 in) long	SOP-E12-150AC 150 mm (6 in) long		
SOP-E12-300SS 300 mm (12 in) long	SOP-E12-300A 300 mm (12 in) long	SOP-E12-300AC 300 mm (12 in) long		
SOP-E12-900SS 900 mm (36 in) long	SOP-E12-900A 900 mm (36 in) long	SOP-E12-900AC 900 mm (36 in) long		
SA-E12M30 - Black Acetal			<ul style="list-style-type: none"> Streamlined black acetal or white UHMW mounting base adapter/cover Connects between ½ in. NPSM/DN15 pipe and 30 mm (1-3/16 in) drilled hole Mounting hardware included 	
SA-E12M30C - White UHMW				

Pipe Mounting Flange

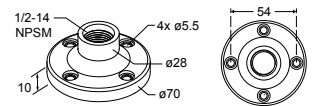
Pipe Mounting Flange			
Model	Features	Construction	
SA-F12	<ul style="list-style-type: none"> For use elevated stand-off pipes (½ in. NPSM/DN15) M5 mounting hardware and nitrile gasket included 	Die-cast zinc base with black paint	

Banner Engineering Corp. Limited Warranty

Banner Engineering Corp. warrants its products to be free from defects in material and workmanship for one year following the date of shipment. Banner Engineering Corp. will repair or replace, free of charge, any product of its manufacture which, at the time it is returned to the factory, is found to have been defective during the warranty period. This warranty does not cover damage or liability for misuse, abuse, or the improper application or installation of the Banner product.

THIS LIMITED WARRANTY IS EXCLUSIVE AND IN LIEU OF ALL OTHER WARRANTIES WHETHER EXPRESS OR IMPLIED (INCLUDING, WITHOUT LIMITATION, ANY WARRANTY OF MERCHANTABILITY OR FITNESS FOR A PARTICULAR PURPOSE), AND WHETHER ARISING UNDER COURSE OF PERFORMANCE, COURSE OF DEALING OR TRADE USAGE.

This Warranty is exclusive and limited to repair or, at the discretion of Banner Engineering Corp., replacement. IN NO EVENT SHALL BANNER ENGINEERING CORP. BE LIABLE TO BUYER OR ANY OTHER PERSON OR ENTITY FOR ANY EXTRA COSTS, EXPENSES, LOSSES, LOSS OF PROFITS, OR ANY INCIDENTAL, CONSEQUENTIAL OR SPECIAL DAMAGES RESULTING FROM ANY PRODUCT DEFECT OR FROM THE USE OR INABILITY TO USE THE PRODUCT, WHETHER ARISING IN CONTRACT OR WARRANTY, STATUTE, TORT, STRICT LIABILITY, NEGLIGENCE, OR OTHERWISE.

Banner Engineering Corp. reserves the right to change, modify or improve the design of the product without assuming any obligations or liabilities relating to any product previously manufactured by Banner Engineering Corp.