

# EZ-LIGHT® TL50BL Beacon Tower Light



## Datasheet



The EZ-LIGHT® TL50 Beacon Tower Light is a cross between the TL50 tower light and the K50 beacon. This compact design is extremely intense and can even be used in outdoor applications.

- Rugged, cost-effective, and easy-to-install multi-segment indicators
- Illuminated segments provide easy-to-see operator guidance and indication of equipment status
- Displays up to 5 colors
- Audible models available with standard, sealed, or omni-directional audible element
- Available in black or light gray housing
- Continuous, pulsed, and staccato tones available
- 12 to 30 V dc or 24 V ac operation
- No assembly required

## Non-Audible Models

Model <sup>1</sup>	# of LED Colors	LED Function <sup>2</sup>	Connection <sup>3</sup>	Inputs
TL50BLRQ	1	Red	4-pin Euro integral QD connector	Bimodal (NPN or PNP)
TL50BLGRQ	2	Green, Red		
TL50BLGYRQ	3	Green, Yellow, Red		
TL50BLBGYRQ	4	Blue, Green, Yellow, Red	5-pin Euro integral QD connector	
TL50BLWBGYRQ	5	White, Blue, Green, Yellow, Red	8-pin Euro integral QD connector	



NOTE: Audible Models are listed on the next page.

For additional models and colors, visit Banner Engineering website at [www.bannerengineering.com](http://www.bannerengineering.com).

<sup>1</sup> Models with black housing are listed. For gray housing, add C at the end of the model number (cabled models) or before the Q (QD models), for example, TL50BLRC or TL50BLRCQ.

<sup>2</sup> The first color listed is the bottom color, going up in successive order. Contact the factory for other colors and color combinations

<sup>3</sup> Integral QD models only are listed; mating cordset required (see [Cordsets](#) on page 5).

- For 150 mm (5.9 in) PVC pigtail with QD, replace Q with QP in the model number, for example, TL50BLRQP.
- For 2 m (6.5 ft) cable, omit suffix Q from the model number, for example, TL50BLR.



## Audible Models

Standard Audible Models <sup>4</sup>			# of LED Colors	LED Function <sup>5</sup>	Connection <sup>6</sup>	Inputs
TL50BLRAQ			1	Red	4-pin Euro integral QD connector	Bimodal (NPN or PNP)
TL50BLGRAQ			2	Green, Red		
TL50BLGYRAQ			3	Green, Yellow, Red	5-pin Euro integral QD connector	
TL50BLBGYRAQ			4	Blue, Green, Yellow, Red	8-pin Euro integral QD connector	
Sealed Audible Models <sup>4</sup>			# of LED Colors	LED Function <sup>5</sup>	Connection <sup>6</sup>	Inputs
Continuous	Pulsed at 1.6 Hz	Staccato				
TL50BLRALSQ	TL50BLRALS3Q	TL50BLRALS4Q	1	Red	4-pin Euro integral QD connector	Bimodal (NPN or PNP)
TL50BLGRALSQ	TL50BLGRALS3Q	TL50BLGRALS4Q	2	Green, Red		
TL50BLGYRALSQ	TL50BLGYRALS3Q	TL50BLGYRALS4Q	3	Green, Yellow, Red	5-pin Euro integral QD connector	
TL50BLBGYRALSQ	TL50BLBGYRALS3Q	TL50BLBGYRALS4Q	4	Blue, Green, Yellow, Red	8-pin Euro integral QD connector	
Omni-Directional Sealed Audible Models <sup>4</sup>			# of LED Colors	LED Function <sup>5</sup>	Connection <sup>6</sup>	Inputs
Continuous	Pulsed at 1.6 Hz	Staccato				
TL50BLRAOSQ	TL50BLRAOS3Q	TL50BLRAOS4Q	1	Red	4-pin Euro integral QD connector	Bimodal (NPN or PNP)
TL50BLGRAOSQ	TL50BLGRAOS3Q	TL50BLGRAOS4Q	2	Green, Red		
TL50BLGYRAOSQ	TL50BLGYRAOS3Q	TL50BLGYRAOS4Q	3	Green, Yellow, Red	5-pin Euro integral QD connector	
TL50BLBGYRAOSQ	TL50BLBGYRAOS3Q	TL50BLBGYRAOS4Q	4	Blue, Green, Yellow, Red	8-pin Euro integral QD connector	
Omni-Directional Sealed Audible Models with Intensity Adjustment <sup>4</sup>			# of LED Colors	LED Function <sup>5</sup>	Connection <sup>6</sup>	Inputs
Continuous	Pulsed at 1.6 Hz	Staccato				
TL50BLRAOSIQ	TL50BLRAOS3IQ	TL50BLRAOS4IQ	1	Red	4-pin Euro integral QD connector	Bimodal (NPN or PNP)
TL50BLGRAOSIQ	TL50BLGRAOS3IQ	TL50BLGRAOS4IQ	2	Green, Red		
TL50BLGYRAOSIQ	TL50BLGYRAOS3IQ	TL50BLGYRAOS4IQ	3	Green, Yellow, Red	5-pin Euro integral QD connector	
TL50BLBGYRAOSIQ	TL50BLBGYRAOS3IQ	TL50BLBGYRAOS4IQ	4	Blue, Green, Yellow, Red	8-pin Euro integral QD connector	

<sup>4</sup> Models with black housing are listed. For gray housing, add suffix C at the end of the model number (cabled models) or before the Q (QD models), for example, TL50BLRAC or TL50BLRACQ.

<sup>5</sup> The first color listed is the bottom color, going up in successive order. Contact the factory for other colors and color combinations.

<sup>6</sup> Integral QD models only are listed; mating cordset required (see [Cordsets](#) on page 5).

- For 150 mm (5.9 in) PVC pigtail with QD, replace Q with QP in the model number, for example, TL50BLRAQP.
- For 2 m (6.5 ft) cable, omit suffix Q from the model number, for example, TL50BLRA.

## Specifications

### Supply Voltage and Current

12–30 V dc (10% maximum ripple); or 21–27 V ac  
Indicators—maximum current per LED color:

- 125 mA at 12 V dc
- 60 mA at 30 V dc
- 80 mA at 21 V ac
- 70 mA at 27 V ac

Standard Audible Alarm: 25 mA maximum current  
Sealed Audible Alarm: 35 mA maximum current  
Omni-Directional Sealed Audible Alarm: 45 mA maximum current  
Use only with a suitable Class 2 power supply or transformer.

### Supply Protection Circuitry

Protected against reverse polarity and transient voltages

### Audible Adjustment

Standard Audible Alarm: Unscrew the cover (up to 1.5 turns maximum) to adjust the audible intensity. (Do not exceed 1.5 turns or the cover may detach during operation.) For maximum intensity, rotate the center plug 180° counterclockwise to remove it.  
Sealed Audible Alarm and Omni-Directional Sealed Audible Alarm with Intensity Adjustment: Rotate the front cover until the desired intensity is reached.  
Omni-Directional Sealed Audible Alarm: No adjustment.

### Vibration and Mechanical Shock

All models meet Mil Std. 202F requirements. Method 201A (vibration: 10 to 60 Hz max., double amplitude 0.06", maximum acceleration 10G). Also meets IEC 947-5-2 requirements: 30G 11 ms duration, half sine wave.

### Operating Conditions

Non-Audible: -40 °C to +50 °C (-40 °F to +122 °F)  
Standard and Sealed Audible: -20 °C to +50 °C (-4 °F to +122 °F)  
95% at +50 °C maximum relative humidity (non-condensing)

### Environmental Rating

Non-Audible and Sealed Audible: IEC IP67  
Standard Audible: IEC IP50

### Certifications



### Audible Alarm

Standard Audible Alarm: 2.7 kHz ± 500 Hz oscillation frequency; maximum intensity 92 dB at 1 m (3.3 ft) (typical)  
Sealed Audible Alarm: 2.9 kHz ± 250 Hz oscillation frequency; maximum intensity 94 dB at 1 m (3.3 ft) (typical)  
Omni-Directional Sealed Audible Alarm: 2.1 kHz ± 250 Hz oscillation frequency; maximum intensity 99 dB at 1 m (3.3 ft) (typical)  
Omni-Directional Sealed Audible Alarm with Intensity Adjustment: 2.1 kHz ± 250 Hz oscillation frequency; maximum intensity 95 dB at 1 m (3.3 ft) (typical)

### Input Response Time

Indicator On/Off: 1 ms (maximum)

### Indicators

LEDs are independently selected: 1 to 5 colors (Green, Red, Yellow, Blue, White) depending on model

### Construction

Bases and Covers: ABS  
Light Segment: Polycarbonate

### Connections

Integral 4-pin, 5-pin, or 8-pin M12/Euro-style QD, 150 mm (6 in) PVC pigtail with QD, or 2 m (6.5 ft) integral cable, depending on model

### Required Overcurrent Protection



**WARNING:** Electrical connections must be made by qualified personnel in accordance with local and national electrical codes and regulations.

Overcurrent protection is required to be provided by end product application per the supplied table.  
Overcurrent protection may be provided with external fusing or via Current Limiting, Class 2 Power Supply.  
Supply wiring leads < 24 AWG shall not be spliced.  
For additional product support, go to <http://www.bannerengineering.com>.

Supply Wiring (AWG)	Required Overcurrent Protection (Amps)
20	5.0
22	3.0
24	2.0
26	1.0
28	0.8
30	0.5

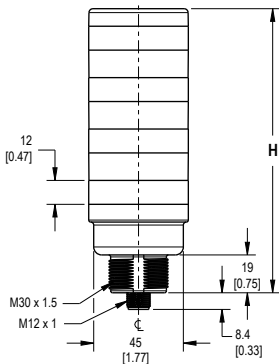

# of Colors	Tower Height (H)			
	Non-Audible	Standard Audible*	Sealed Audible	Omni-Directional Sealed Audible
1	46.2 mm (1.8 in)	77.1 mm (3.1 in)	100.2 mm (4.0 in)	114.2 mm (4.5 in)
2	72.0 mm (2.8 in)	102.9 mm (4.1 in)	126.0 mm (5.0 in)	140.0 mm (5.5 in)
3	97.8 mm (3.8 in)	128.7 mm (5.1 in)	151.8 mm (6.0 in)	165.8 mm (6.5 in)
4	123.6 mm (4.8 in)	154.5 mm (6.1 in)	177.6 mm (7.0 in)	191.6 mm (7.5 in)
5	149.4 mm (5.8 in)	-	-	-

\* Tower height (H) with top unscrewed approximately 3.5 mm to allow sound to escape

## Wiring Diagram – 4-Pin Models

Sourcing (PNP) Input

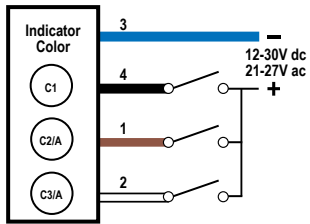

Sinking (NPN) Input

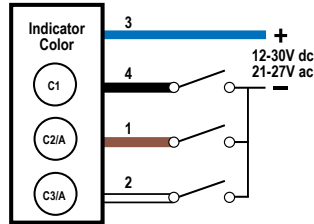

Key:

- |           |              |
|-----------|--------------|
| 1 = Brown | C1 = Color 1 |
| 2 = White | C2 = Color 2 |
| 3 = Blue  | C3 = Color 3 |
| 4 = Black | A = Audible  |

Pins 1 and 2 could activate the corresponding color or the audible function, if available.

## Wiring Diagram – 5-Pin Models

Sourcing (PNP) Input

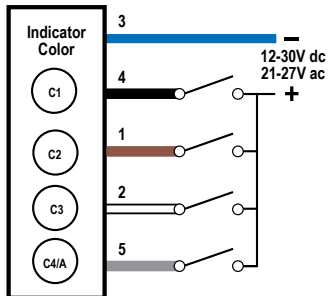

Sinking (NPN) Input

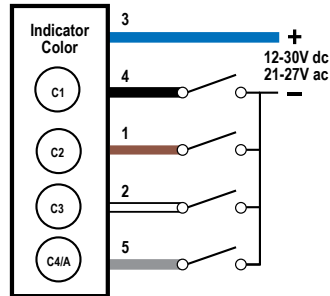

Key:

- |           |              |
|-----------|--------------|
| 1 = Brown | C1 = Color 1 |
| 2 = White | C2 = Color 2 |
| 3 = Blue  | C3 = Color 3 |
| 4 = Black | C4 = Color 4 |
| 5 = Gray  | A = Audible  |

Pin 5 could activate the corresponding color or the audible function, if available.

## Wiring Diagram – 8-Pin Models

Sourcing (PNP) Input

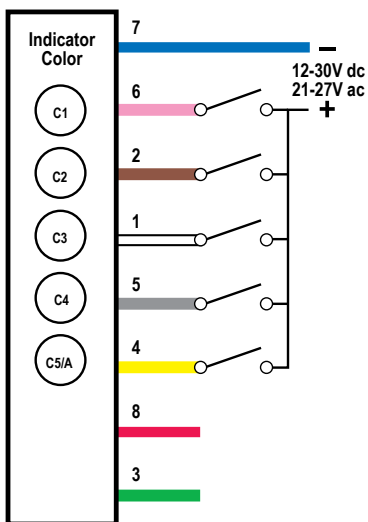

Sinking (NPN) Input

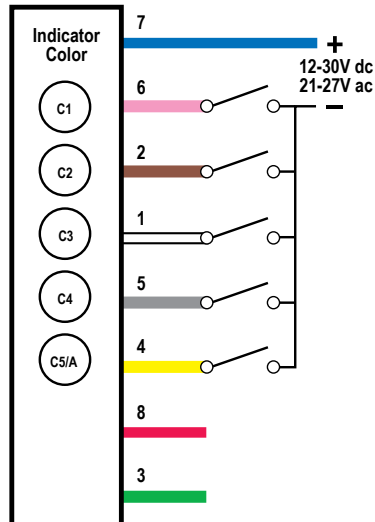

Key:

- |            |              |
|------------|--------------|
| 1 = White  | C1 = Color 1 |
| 2 = Brown  | C2 = Color 2 |
| 3 = Green  | C3 = Color 3 |
| 4 = Yellow | C4 = Color 4 |
| 5 = Gray   | C5 = Color 5 |
| 6 = Pink   | A = Audible  |
| 7 = Blue   |              |
| 8 = Red    |              |

Pin 4 could activate the corresponding color or the audible function, if available. Pins 3 and 8 are not used.

## Accessories

### Cordsets

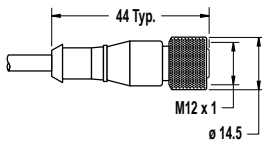
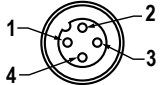
4-Pin Threaded M12/Euro-Style Cordsets				
Model	Length	Style	Dimensions	Pinout (Female)
MQDC-406	1.83 m (6 ft)	Straight		 <p>1 = Brown 2 = White 3 = Blue 4 = Black</p>
MQDC-415	4.57 m (15 ft)			
MQDC-430	9.14 m (30 ft)			
MQDC-450	15.2 m (50 ft)			

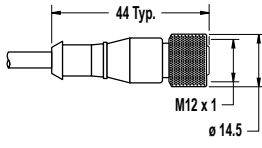
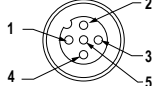
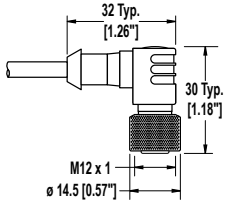
5-Pin Threaded M12/Euro-Style Cordsets—Single Ended				
Model	Length	Style	Dimensions	Pinout (Female)
MQDC1-501.5	0.50 m (1.5 ft)	Straight		 <p>1 = Brown 2 = White 3 = Blue 4 = Black 5 = Gray</p>
MQDC1-506	1.83 m (6 ft)			
MQDC1-515	4.57 m (15 ft)			
MQDC1-530	9.14 m (30 ft)			
MQDC1-506RA	1.83 m (6 ft)	Right-Angle		
MQDC1-515RA	4.57 m (15 ft)			
MQDC1-530RA	9.14 m (30 ft)			

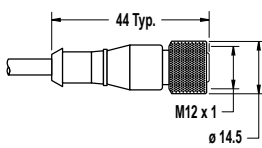
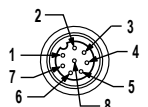
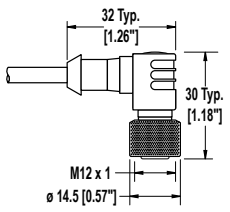
8-Pin Threaded M12/Euro-Style Cordsets with Open-Shield				
Model	Length	Style	Dimensions	Pinout (Female)
MQDC2S-806	1.83 m (6 ft)	Straight		 <p>1 = White 2 = Brown 3 = Green 4 = Yellow 5 = Gray 6 = Pink 7 = Blue 8 = Red</p>
MQDC2S-815	4.57 m (15 ft)			
MQDC2S-830	9.14 m (30 ft)			
MQDC2S-850	15.2 m (50 ft)			
MQDC2S-806RA	1.83 m (6 ft)	Right-Angle		
MQDC2S-815RA	4.57 m (15 ft)			
MQDC2S-830RA	9.14 m (30 ft)			
MQDC2S-850RA	15.2 m (50 ft)			

## Mounting Brackets

### SMB30A

- Right-angle bracket with curved slot for versatile orientation
- Clearance for M6 (¼ in) hardware
- Mounting hole for 30 mm sensor
- 12-ga. stainless steel

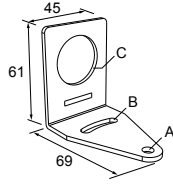

Hole center spacing: A to B=40  
Hole size: A=∅ 6.3, B= 27.1 x 6.3, C=∅ 30.5

### SMB30FA

- Swivel bracket with tilt and pan movement for precise adjustment
- Mounting hole for 30 mm sensor
- 12-ga. 304 stainless steel
- Easy sensor mounting to extrude rail T-slot
- Metric and inch size bolt available

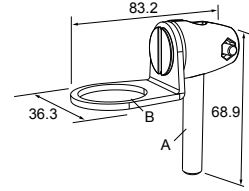

Bolt thread: SMB30FA, A= 3/8 - 16 x 2 in; SMB30FAM10, A= M10 - 1.5 x 50  
Hole size: B= ∅ 30.1

### SMB30MM

- 12-ga. stainless steel bracket with curved mounting slots for versatile orientation
- Clearance for M6 (¼ in) hardware
- Mounting hole for 30 mm sensor

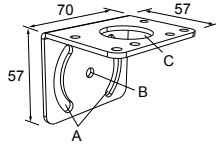

Hole center spacing: A = 51, A to B = 25.4  
Hole size: A = 42.6 x 7, B = ∅ 6.4, C = ∅ 30.1

### SMBAMS30P

- Flat SMBAMS series bracket
- 30 mm hole for mounting sensors
- Articulation slots for 90° + rotation
- 12-ga. 300 series stainless steel

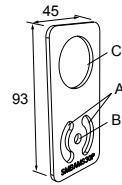

Hole center spacing: A=26.0, A to B=13.0  
Hole size: A=26.8 x 7.0, B=∅ 6.5, C=∅ 31.0

### SMBAMS30RA

- Right-angle SMBAMS series bracket
- 30 mm hole for mounting sensors
- Articulation slots for 90° + rotation
- 12-ga. (2.6 mm) cold-rolled steel

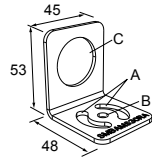

Hole center spacing: A=26.0, A to B=13.0  
Hole size: A=26.8 x 7.0, B=∅ 6.5, C=∅ 31.0

### SMB30SC

- Swivel bracket with 30 mm mounting hole for sensor
- Black reinforced thermoplastic polyester
- Stainless steel mounting and swivel locking hardware included

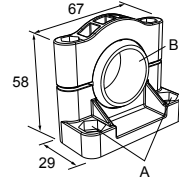



Hole center spacing: A=∅ 50.8  
Hole size: A=∅ 7.0, B=∅ 30.0

All measurements are listed in millimeters (inches), unless noted otherwise.

## LMB Sealed Right-Angle Bracket

Model	Description	Construction	
LMB30RA	Direct-Mount Models: Bracket kit with base, 30 mm adapter, set screw, fasteners, o-rings, and gaskets	Black polycarbonate	
LMB30RAC		Gray polycarbonate	
LMBE12RA	Pipe-Mount Models: Bracket kit with base, ½-14 pipe adapter, set screw, fasteners, o-rings, and gaskets. For use with stand-off pipe (listed and sold separately)	Black polycarbonate	
LMBE12RAC		Gray polycarbonate	

## Elevated Mount System

Model			Features	Components
SA-M30TE12 - Black Acetal			<ul style="list-style-type: none"> <li>Streamlined black acetal or white UHMW stand-off pipe adapter/cover</li> <li>Connects between 30 mm light base and ½ in. NPSM/DN15 pipe</li> <li>Mounting hardware included</li> </ul>	
SA-M30TE12C - White UHMW				
Polished 304 Stainless Steel	Black Anodized Aluminum	Clear Anodized Aluminum	<ul style="list-style-type: none"> <li>Elevated-use stand-off pipe (½ in. NPSM/DN15)</li> <li>Polished 304 stainless steel, black anodized aluminum, or clear anodized aluminum surface</li> <li>½ in. NPT thread at both ends</li> <li>Compatible with most industrial environments</li> </ul>	
SOP-E12-150SS 150 mm (6 in) long	SOP-E12-150A 150 mm (6 in) long	SOP-E12-150AC 150 mm (6 in) long		
SOP-E12-300SS 300 mm (12 in) long	SOP-E12-300A 300 mm (12 in) long	SOP-E12-300AC 300 mm (12 in) long		
SOP-E12-900SS 900 mm (36 in) long	SOP-E12-900A 900 mm (36 in) long	SOP-E12-900AC 900 mm (36 in) long		
SA-E12M30 - Black Acetal			<ul style="list-style-type: none"> <li>Streamlined black acetal or white UHMW mounting base adapter/cover</li> <li>Connects between ½ in. NPSM/DN15 pipe and 30 mm (1-3/16 in) drilled hole</li> <li>Mounting hardware included</li> </ul>	
SA-E12M30C - White UHMW				

## Pipe Mounting Flange

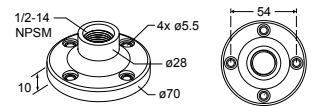
Pipe Mounting Flange			
Model	Features	Construction	
SA-F12	<ul style="list-style-type: none"> <li>For use elevated stand-off pipes (½ in. NPSM/DN15)</li> <li>M5 mounting hardware and nitrile gasket included</li> </ul>	Die-cast zinc base with black paint	

## Banner Engineering Corp. Limited Warranty

Banner Engineering Corp. warrants its products to be free from defects in material and workmanship for one year following the date of shipment. Banner Engineering Corp. will repair or replace, free of charge, any product of its manufacture which, at the time it is returned to the factory, is found to have been defective during the warranty period. This warranty does not cover damage or liability for misuse, abuse, or the improper application or installation of the Banner product.

THIS LIMITED WARRANTY IS EXCLUSIVE AND IN LIEU OF ALL OTHER WARRANTIES WHETHER EXPRESS OR IMPLIED (INCLUDING, WITHOUT LIMITATION, ANY WARRANTY OF MERCHANTABILITY OR FITNESS FOR A PARTICULAR PURPOSE), AND WHETHER ARISING UNDER COURSE OF PERFORMANCE, COURSE OF DEALING OR TRADE USAGE.

This Warranty is exclusive and limited to repair or, at the discretion of Banner Engineering Corp., replacement. IN NO EVENT SHALL BANNER ENGINEERING CORP. BE LIABLE TO BUYER OR ANY OTHER PERSON OR ENTITY FOR ANY EXTRA COSTS, EXPENSES, LOSSES, LOSS OF PROFITS, OR ANY INCIDENTAL, CONSEQUENTIAL OR SPECIAL DAMAGES RESULTING FROM ANY PRODUCT DEFECT OR FROM THE USE OR INABILITY TO USE THE PRODUCT, WHETHER ARISING IN CONTRACT OR WARRANTY, STATUTE, TORT, STRICT LIABILITY, NEGLIGENCE, OR OTHERWISE.

Banner Engineering Corp. reserves the right to change, modify or improve the design of the product without assuming any obligations or liabilities relating to any product previously manufactured by Banner Engineering Corp.