

EZ-LIGHT® Touch K30 Series Illuminated Buttons

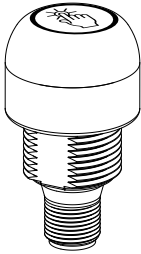

Datasheet

Lighted touch button with bipolar outputs



- Rugged, cost-effective, and easy-to-install touch button with multicolor light
- Momentary versions remain activated as long as touch is present
- Latching versions start up not activated and toggle between activated and not activated on successive touches
- Waterproof IP69K construction for washdown environments
- Ergonomically designed to eliminate hand, wrist, and arm stresses associated with repeated switch operation; require no physical force to operate
- Can be actuated with bare hands or in gloves
- 12 to 30 V dc operation

Models

Model ¹	Function	Output	Light (not activated)	Light (activated)	Connection		
K30ALBTXGHQ	Latching	Bipolar, N.O.	-	Green	Integral 5-pin M12/ Euro-style QD		
K30RLBTXGHQ		Bipolar, N.C.					
K30ABTXGHQ	Momentary	Bipolar, N.O.					
K30RBTXGHQ		Bipolar, N.C.					
K30ALBTGGHQ	Latching	Bipolar, N.O.		Green		Green	
K30RLBTGGHQ		Bipolar, N.C.					
K30ABTGGHQ	Momentary	Bipolar, N.O.					
K30RBTGGHQ		Bipolar, N.C.					
K30ALBTRGHQ	Latching	Bipolar, N.O.				Red	Green
K30RLBTRGHQ		Bipolar, N.C.					
K30ABTRGHQ	Momentary	Bipolar, N.O.					
K30RBTTRGHQ		Bipolar, N.C.					

¹ 5-pin integral QD models only are listed.

- For 5-pin 150 mm (5.9 in) Eurostyle PVC pigtail, replace suffix Q with QP in model number (example, K30ALBTXGHQP).
- For 2 m (6.5 ft) cable, omit suffix Q from model number (example, K30ALBTXGH).
- A model with a QD requires a mating cable.



Specifications

Supply Voltage

12 to 30 V dc

Supply Current

55 mA max current (exclusive of load)

Supply Protection Circuitry

Protected against reverse polarity and transient voltages

Output Rating

Maximum Load: 150 mA

ON-state saturation voltage: < 2V at 10 mA dc; < 2.5V at 150 mA dc

OFF-state leakage current < 10 μ A at 30 V dc

Environmental Rating

IEC IP67, IP69K per DIN 40050-9. Cabled models also meet IP69K if the cable and cable entrance are protected from high-pressure spray.

Operating Conditions

-40 °C to +50 °C (-40 °F to +122 °F)

90% at 50 °C max. relative humidity (non-condensing)

Storage

-40 °C to +70 °C (-40 °F to +158 °F)

Vibration and Mechanical Shock

All models meet Mil. Std. 202F requirements method 201A (vibration: 10 to 60 Hz max., double amplitude 0.06 in. maximum acceleration 10G). Also meets IEC 947-5-2; 30G 11 ms duration, half sine wave.

Output Response Time

150 milliseconds ON and OFF

Power-Up

Device requires 300 milliseconds to start up

Latching models startup in not activated state

Connections

5-pin integral Euro-style QD, 2 m (6.5 ft) PVC integral cable, or 5-pin

150 mm (5.9 in) Euro-style PVC pigtail QD

Construction

Housing: polycarbonate

Translucent dome: polycarbonate

Mounting Nut: PBT

Mounting

M22 \times 1.5 Threaded base, max torque 2.25 Nm (20 in-lbf)

Certifications



Required Overcurrent Protection



WARNING: Electrical connections must be made by qualified personnel in accordance with local and national electrical codes and regulations.

Overcurrent protection is required to be provided by end product application per the supplied table.

Overcurrent protection may be provided with external fusing or via Current Limiting, Class 2 Power Supply.

Supply wiring leads < 24 AWG shall not be spliced.

For additional product support, go to <http://www.bannerengineering.com>.

Supply Wiring	Required Overcurrent Protection
20	5.0 Amps
22	3.0 Amps
24	2.0 Amps
26	1.0 Amps
28	0.8 Amps
30	0.5 Amps

Dimensions

All measurements are listed in millimeters (inches), unless noted otherwise.

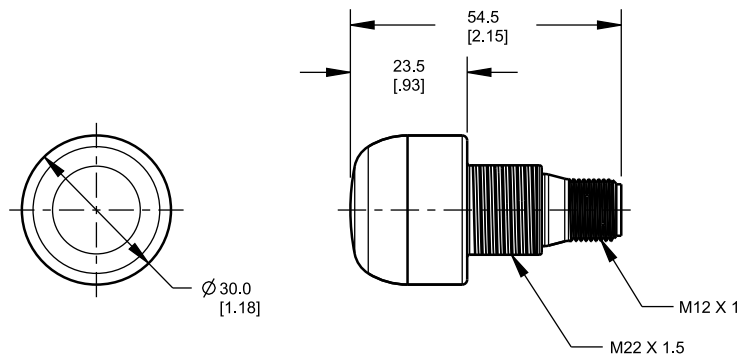

Wiring Diagram

Bipolar

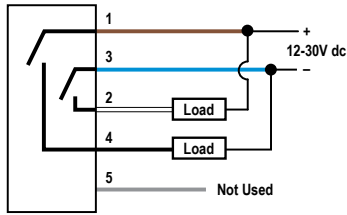

Color Key:

- 1 = Brown
- 2 = White
- 3 = Blue
- 4 = Black
- 5 = Gray

Accessories

Cordsets

5-Pin Threaded M12/Euro-Style Cordsets (Single Ended)				
Model	Length	Style	Dimensions	Pinout (Female)
MQDC1-501.5	0.50 m (1.5 ft)	Straight		<ul style="list-style-type: none"> 1 = Brown 2 = White 3 = Blue 4 = Black 5 = Gray
MQDC1-506	1.83 m (6 ft)			
MQDC1-515	4.57 m (15 ft)			
MQDC1-530	9.14 m (30 ft)			
MQDC1-506RA	1.83 m (6 ft)	Right-Angle		
MQDC1-515RA	4.57 m (15 ft)			
MQDC1-530RA	9.14 m (30 ft)			

Brackets

All measurements are listed in millimeters, unless noted otherwise.

SMB22A

- Right-angle bracket with curved slot for versatile orientation
- 12-ga. stainless steel
- Mounting hole for 22 mm sensor

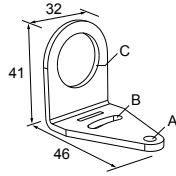

Hole center spacing: A to B = 26.0
Hole size: A = \varnothing 4.6, B = 4.6 x 16.9, C = 22.2

SMB22FVK

- V-clamp, flat bracket and fasteners for mounting to pipe or extensions
- Clamp accommodates 28 mm diameter tubing or 1 in. square extrusions
- 22 mm hole for mounting sensor

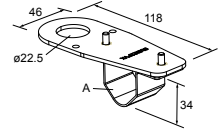

Hole size: A = \varnothing 22.5

SMB22RAVK

- V-clamp, right-angle bracket and fasteners for mounting to pipe or extensions
- Clamp accommodates 28 mm diameter tubing or 1 in. square extrusions
- 22 mm hole for mounting sensor

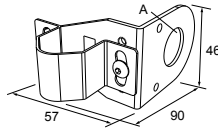

Hole size: A = \varnothing 22.5

SMBAMS22P

- Flat SMBAMS series bracket with 22 mm hole for mounting sensors
- Articulation slots for 90+° rotation
- 12-ga. (2.6 mm) cold-rolled steel

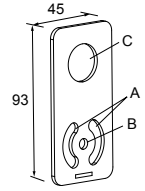

Hole center spacing: A = 26.0, A to B = 13.0

Hole size: A = 26.8 x 7.0, B = \varnothing 6.5, C = \varnothing 22.5

SMBAMS22RA

- Right-angle SMBAMS series bracket with 22 mm hole for mounting sensors
- Articulation slots for 90+° rotation
- 12-ga. (2.6 mm) cold-rolled steel

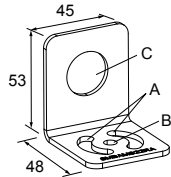

Hole center spacing: A = 26.0, A to B = 13.0

Hole size: A = 26.8 x 7.0, B = \varnothing 6.5, C = \varnothing 22.5

Banner Engineering Corp. Limited Warranty

Banner Engineering Corp. warrants its products to be free from defects in material and workmanship for one year following the date of shipment. Banner Engineering Corp. will repair or replace, free of charge, any product of its manufacture which, at the time it is returned to the factory, is found to have been defective during the warranty period. This warranty does not cover damage or liability for misuse, abuse, or the improper application or installation of the Banner product.

THIS LIMITED WARRANTY IS EXCLUSIVE AND IN LIEU OF ALL OTHER WARRANTIES WHETHER EXPRESS OR IMPLIED (INCLUDING, WITHOUT LIMITATION, ANY WARRANTY OF MERCHANTABILITY OR FITNESS FOR A PARTICULAR PURPOSE), AND WHETHER ARISING UNDER COURSE OF PERFORMANCE, COURSE OF DEALING OR TRADE USAGE.

This Warranty is exclusive and limited to repair or, at the discretion of Banner Engineering Corp., replacement. IN NO EVENT SHALL BANNER ENGINEERING CORP. BE LIABLE TO BUYER OR ANY OTHER PERSON OR ENTITY FOR ANY EXTRA COSTS, EXPENSES, LOSSES, LOSS OF PROFITS, OR ANY INCIDENTAL, CONSEQUENTIAL OR SPECIAL DAMAGES RESULTING FROM ANY PRODUCT DEFECT OR FROM THE USE OR INABILITY TO USE THE PRODUCT, WHETHER ARISING IN CONTRACT OR WARRANTY, STATUTE, TORT, STRICT LIABILITY, NEGLIGENCE, OR OTHERWISE.

Banner Engineering Corp. reserves the right to change, modify or improve the design of the product without assuming any obligations or liabilities relating to any product previously manufactured by Banner Engineering Corp.