

Ball valves VAPB, VZBA, VZBC



# Ball valves VAPB, VZBA, VZBC

Key features and product range overview

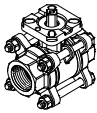
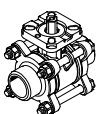
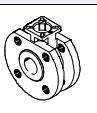
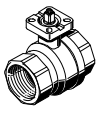

Function	Design	Type	Process valve connection	Nominal size DN	Flange hole pattern to ISO 5211	Process valve nominal pressure PN	→ Page/Internet	
Ball valve, 2-way		<b>Stainless steel, corrosion-resistant with pipe thread to EN 10226-1 (previously DIN 2999)</b>						5
		VZBA-...-GG	Rp1/4	8	F0304	63		
			Rp3/8	10	F0304			
			Rp1/2	15	F0304			
			Rp3/4	20	F0304			
			Rp1	25	F0405			
			Rp1 1/4	32	F0405			
			Rp1 1/2	40	F0507			
			Rp2	50	F0507			
			Rp2 1/2	65	F0710			
			Rp3	80	F0710			
	Rp4	100	F10					
		<b>Stainless steel, corrosion-resistant with welding ends</b>						5
		VZBA-...-WW	–	8	F0304	63		
				10	F0304			
				15	F0304			
				20	F0304			
				25	F0405			
				32	F0405			
				40	F0507			
				50	F0507			
				65	F0710			
				80	F0710			
		100	F10					
		<b>Stainless steel, corrosion-resistant in compact design</b>						11
		VZBC-...-FF	Ring housing with threaded flange	15	F0304	40		
				20	F0304			
				25	F0405			
				32	F0405			
				40	F0507			
				50	F0507			
				65	F07	16		
				80	F07			
100				F0710				
<b>Brass</b>								
	VAPB	Rp1/4	8	F03	40	17		
		Rp3/8	10	F03	40			
		Rp1/2	15	F03	40			
		Rp3/4	20	F03	40			
		Rp1	25	F0304	40			
		Rp1 1/4	32	F0405	40			
		Rp1 1/2	40	F0405	25			
		Rp2	50	F05	25			
		Rp2 1/2	65	F07	25			

# Ball valves VAPB, VZBA, VZBC

Key features and product range overview

Function	Design	Type	Process valve connection	Nominal size DN	Flange hole pattern to ISO 5211	Process valve nominal pressure PN	→ Page/Internet		
Ball valve, 3-way		VZBA	Stainless steel, corrosion-resistant					63	22
			Rp1/4	8	F0304				
			Rp3/8	10	F0304				
			Rp1/2	15	F0304				
			Rp3/4	20	F0405				
			Rp1	25	F0405				
			Rp1 1/4	32	F0405				
			Rp1 1/2	40	F0405				
			Rp2	50	F05				
			Rp1/4	8	F0304				
			Rp3/8	10	F0304				
			Rp1/2	15	F0304				
			Rp3/4	20	F0405				
			Rp1	25	F0405				
			Rp1 1/4	32	F0405				
			Rp1 1/2	40	F0405				
			Rp2	50	F05				

# Ball valves VZBA, 2-way, stainless steel

Type codes

FESTO

VZBA - 1/4 - G G - 63 - T - 22 - F0304 - V4 V4 - T

## Type

VZBA	Ball valve
------	------------

## Nominal size DN

1/4	DN8
3/8	DN10
1/2	DN15
3/4	DN20
1	DN25
1 1/4	DN32
1 1/2	DN40
2	DN50
2 1/2	DN65
3	DN80
4	DN100

## Connection type 1

G	Pipe thread to EN 10226-1
W	Welding end

## Connection type 2

G	Pipe thread to EN 10226-1
W	Welding end

## Process valve nominal pressure PN

63	63 bar
----	--------

## Design

T	Three-piece
---	-------------

## Directional control function

22	2/2-way
----	---------

## Flange connection to ISO 5211

F0304	2 pitch circle diameters of 36 mm and 42 mm
F0405	2 pitch circle diameters of 42 mm and 50 mm
F0507	2 pitch circle diameters of 50 mm and 70 mm
F07	1 pitch circle diameter of 70 mm
F0710	2 pitch circle diameters of 70 mm and 102 mm
F10	1 pitch circle diameter of 102 mm

## Housing material

V4	Stainless steel 1.4401, 1.4404 (AISI 316L), 1.4408
----	--

## Material for shut-off element

V4	Stainless steel 1.4401, 1.4404 (AISI 316L), 1.4408
----	--

## Sealing material

T	PTFE
---	------

# Ball valves VZBA, 2-way, stainless steel

Technical data

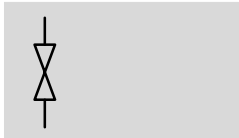

- 2-way ball valve made from stainless steel
- With pipe thread or welding end



- - Connecting thread  
Rp1/4 ... Rp4

- - Flow rate Kv  
7 ... 1,414 m<sup>3</sup>/h

General technical data												
Process valve connection	Rp1/4	Rp3/8	Rp1/2	Rp3/4	Rp1	Rp1 1/4	Rp1 1/2	Rp2	Rp2 1/2	Rp3	Rp4	
Nominal size DN	8	10	15	20	25	32	40	50	65	80	100	
Valve function	2/2-way											
Design	2-way ball valve											
Sealing principle	Soft											
Actuation type	Mechanical											
Manual override	None											
Switching position display	Slot direction = flow direction											
Direction of flow	Reversible											
Type of mounting	In-line installation											
Mounting position	Any											
Based on standard with pipe thread	ISO 5211											
	DIN 3202-M3											
	EN 10226-1											
Based on standard with welding end	ISO 5211											
	DIN 3202-S13											
Actuation moment [Nm]	6	6	10	14	17	24	29	44	78	112	140	
Internal diameter [mm]	10	12	16	20	25	32	38	50	65	80	100	
Flow rate Kv [m <sup>3</sup> /h]	7	10	19.4	45.6	71.5	105	170	275	507	905	1,414	
Product weight [g]	650	650	650	850	1,250	1,850	2,800	4,550	9,200	13,950	22,300	

Operating and environmental conditions												
Process valve connection	Rp1/4	Rp3/8	Rp1/2	Rp3/4	Rp1	Rp1 1/4	Rp1 1/2	Rp2	Rp2 1/2	Rp3	Rp4	
Operating medium	Compressed air to ISO 8573-1:2010 [:::]											
Process valve operating medium	Neutral liquids											
	Inert gases											
	Water – no water vapour											
Process valve nominal pressure <sup>1)</sup>	PN 63											
Temperature of medium <sup>2)</sup> [°C]	-10 ... 200											
Corrosion resistance class CRC <sup>3)</sup>	3											
CE marking (see declaration of conformity) ➔ <a href="http://www.festo.com">www.festo.com</a>	-							To EU Pressure Equipment Directive				

1) PN class to DIN EN 1333

2) As a function of operating pressure ➔ 6

3) Corrosion resistance class CRC 3 to Festo standard FN 940070

High corrosion stress. Outdoor exposure under moderate corrosive conditions. External visible parts with primarily functional requirements for the surface and which are in direct contact with a normal industrial environment.

# Ball valves VZBA, 2-way, stainless steel

Technical data

Materials	Information on materials	Material number
Housing	High-alloy stainless steel	1.4408
Ball		1.4401, 1.4408
Shaft		1.4401
Seals	Housing	PTFE
	Shaft	PTFE reinforced
Note on materials	RoHS-compliant, contains paint-wetting impairment substances	

## Permissible operating pressure p as a function of temperature of the medium t

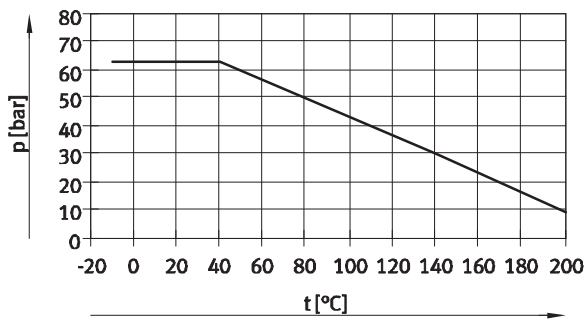

# Ball valves VZBA, 2-way, stainless steel

Technical data

FESTO

## Dimensions

Download CAD data → [www.festo.com](http://www.festo.com)

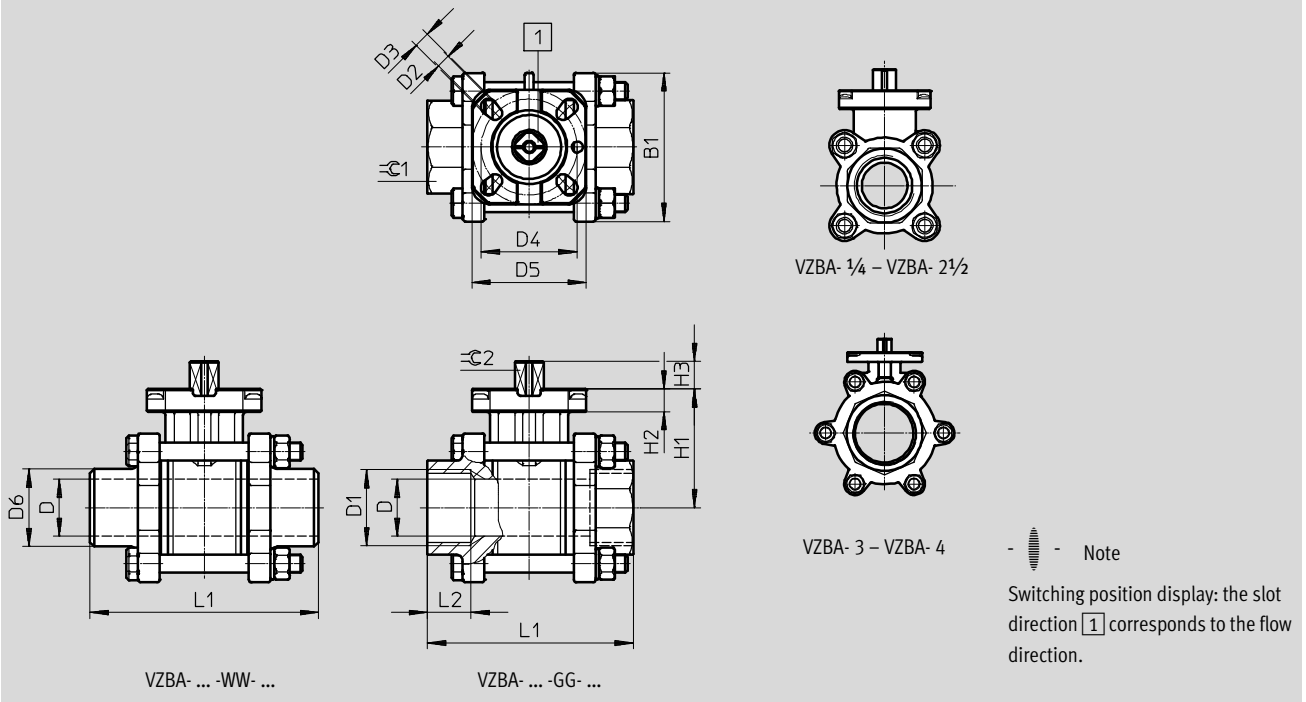

Type	B1	D ∅ ±0.15	D1	D2 ∅	D3 ∅	D4 ∅	D5 ∅	D6	H1	H2	H3 ±0.5	L1 ±2	L2	⊖ 1	⊖ 2 -0.1
VZBA-1/4-GG-63-T-22-F0304-V4V4T	42	10	Rp1/4	6	6	36	42	-	40	9	8.5	65	14.5	24	9
VZBA-3/8-GG-63-T-22-F0304-V4V4T	42	12	Rp3/8	6	6	36	42	-	40	9	8.5	65	14.5	24	9
VZBA-1/2-GG-63-T-22-F0304-V4V4T	49	16	Rp1/2	6	6	36	42	-	40	9	8.5	75	16	29	9
VZBA-3/4-GG-63-T-22-F0304-V4V4T	54	20	Rp3/4	6	6	36	42	-	44	9	8.5	80	17	35	9
VZBA-1-GG-63-T-22-F0405-V4V4T	60.5	25	Rp1	6	7	42	50	-	52	10	11.5	90	19	41	11
VZBA-1 1/4-GG-63-T-22-F0405-V4V4T	71.5	32	Rp1 1/4	6	7	42	50	-	58	10	11.5	110	23	50	11
VZBA-1 1/2-GG-63-T-22-F0507-V4V4T	80.5	38	Rp1 1/2	7	9	50	70	-	68	13	15.5	120	24	58	14
VZBA-2-GG-63-T-22-F0507-V4V4T	99.5	50	Rp2	7	9	50	70	-	77	13	15.5	140	25.8	73	14
VZBA-2 1/2-GG-63-T-22-F0710-V4V4T	127	65	Rp2 1/2	9	11	70	102	-	98	13	18.5	185	34	90	17
VZBA-3-GG-63-T-22-F0710-V4V4T	191	80	Rp3	9	11	70	102	-	110	13	18.5	205	36	105	17
VZBA-4-GG-63-T-22-F10-V4V4T	222	100	Rp4	-	11	-	102	-	138	16	23.5	240	38	135	22
VZBA-1/4"-WW-63-T-22-F0304-V4V4T	42	10	-	6	6	36	42	16	40	9	8.5	70	-	-	9
VZBA-3/8"-WW-63-T-22-F0304-V4V4T	42	12	-	6	6	36	42	18	40	9	8.5	70	-	-	9
VZBA-1/2"-WW-63-T-22-F0304-V4V4T	49	16	-	6	6	36	42	22	40	9	8.5	75	-	-	9
VZBA-3/4"-WW-63-T-22-F0304-V4V4T	54	20	-	6	6	36	42	28	44	9	8.5	90	-	-	9
VZBA-1"-WW-63-T-22-F0405-V4V4T	60.5	25	-	6	7	42	50	35	52	10	11.5	100	-	-	11
VZBA-1 1/4"-WW-63-T-22-F0405-V4V4T	71.5	32	-	6	7	42	50	44	58	10	11.5	110	-	-	11
VZBA-1 1/2"-WW-63-T-22-F0507-V4V4T	80.5	38	-	7	9	50	70	50	68	13	15.5	125	-	-	14
VZBA-2"-WW-63-T-22-F0507-V4V4T	99.5	50	-	7	9	50	70	62	77	13	15.5	150	-	-	14
VZBA-2 1/2"-WW-63-T-22-F0710-V4V4T	127	65	-	9	11	70	102	77	98	13	18.5	190	-	-	17
VZBA-3"-WW-63-T-22-F0710-V4V4T	191	80	-	9	11	70	102	91	110	13	18.5	220	-	-	17
VZBA-4"-WW-63-T-22-F10-V4V4T	222	100	-	-	11	-	102	117	138	16	23.5	270	-	-	22

# Ball valves VZBA, 2-way, stainless steel

Technical data

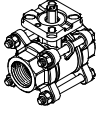
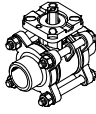
Ordering data			
Version with pipe thread	Process valve connection	Part No.	Type
	Rp $\frac{1}{4}$	1686625	VZBA- $\frac{1}{4}$ -GG-63-T-22-F0304-V4V4T
	Rp $\frac{3}{8}$	1686632	VZBA- $\frac{3}{8}$ -GG-63-T-22-F0304-V4V4T
	Rp $\frac{1}{2}$	1686636	VZBA- $\frac{1}{2}$ -GG-63-T-22-F0304-V4V4T
	Rp $\frac{3}{4}$	1686639	VZBA- $\frac{3}{4}$ -GG-63-T-22-F0304-V4V4T
	Rp1	1686640	VZBA-1-GG-63-T-22-F0405-V4V4T
	Rp1 $\frac{1}{4}$	1686641	VZBA-1 $\frac{1}{4}$ -GG-63-T-22-F0405-V4V4T
	Rp1 $\frac{1}{2}$	1686643	VZBA-1 $\frac{1}{2}$ -GG-63-T-22-F0507-V4V4T
	Rp2	1686646	VZBA-2-GG-63-T-22-F0507-V4V4T
	Rp2 $\frac{1}{2}$	1686648	VZBA-2 $\frac{1}{2}$ -GG-63-T-22-F0710-V4V4T
	Rp3	1686651	VZBA-3-GG-63-T-22-F0710-V4V4T
Rp4	1686654	VZBA-4-GG-63-T-22-F10-V4V4T	
Version with welding end	Process valve connection	Part No.	Type
	With welding end	1686656	VZBA-1/4"-WW-63-T-22-F0304-V4V4T
		1686662	VZBA-3/8"-WW-63-T-22-F0304-V4V4T
		1686663	VZBA-1/2"-WW-63-T-22-F0304-V4V4T
		1686665	VZBA-3/4"-WW-63-T-22-F0304-V4V4T
		1686689	VZBA-1"-WW-63-T-22-F0405-V4V4T
		1686696	VZBA-1 $\frac{1}{4}$ "-WW-63-T-22-F0405-V4V4T
		1686697	VZBA-1 $\frac{1}{2}$ "-WW-63-T-22-F0507-V4V4T
		1686699	VZBA-2"-WW-63-T-22-F0507-V4V4T
		1686702	VZBA-2 $\frac{1}{2}$ "-WW-63-T-22-F0710-V4V4T
		1686704	VZBA-3"-WW-63-T-22-F0710-V4V4T
1686705	VZBA-4"-WW-63-T-22-F10-V4V4T		



# Ball valves VZBA, 2-way, stainless steel

Accessories

## Hand lever VAOH

Information on materials:

- High-alloy stainless steel
- Free of copper and PTFE
- Contains PWIS (paint-wetting impairment substances)



### Dimensions and ordering data

Download CAD data → [www.festo.com](http://www.festo.com)

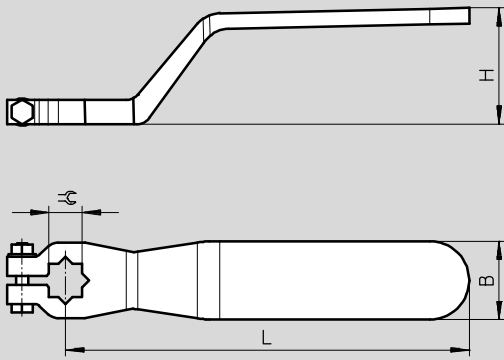

For connection	$\approx C$ $\pm 0.5$	L $\pm 10$	H $\pm 5$	B $\pm 5$	Weight [g]	Part No.	Type
Rp1/4 ... Rp3/4	9	120	36	21	100	542702	VAOH-9-H9
Rp1 ... Rp1 1/4	11	140	40	26	200	542703	VAOH-11-H9
Rp1 1/2 ... Rp2	14	180	46	31	300	542704	VAOH-14-H9
Rp2 1/2 ... Rp3	17	240	55	36	450	542705	VAOH-17-H9
Rp4	22	280	70	36	750	542706	VAOH-22-H9

# Ball valves VZBC, 2-way, stainless steel, compact design

Type codes

VZBC – 15 – F F – 40 – 22 – F0304 – V4 V4 T

**Type**

VZBC	Ball valve
------	------------

**Nominal size DN**

15	DN15
20	DN20
25	DN25
32	DN32
40	DN40
50	DN50
65	DN65
80	DN80
100	DN100

**Connection type 1**

F	Flange to EN 1092-1
---	---------------------

**Connection type 2**

F	Flange to EN 1092-1
---	---------------------

**Process valve nominal pressure PN**

40	40 bar
16	16 bar

**Directional control function**

22	2/2-way
----	---------

**Flange connection to ISO 5211**

F0304	2 pitch circle diameters of 36 mm and 42 mm
F0405	2 pitch circle diameters of 42 mm and 50 mm
F0507	2 pitch circle diameters of 50 mm and 70 mm
F07	1 pitch circle diameter of 70 mm
F0710	2 pitch circle diameters of 70 mm and 102 mm

**Housing material**

V4	Stainless steel 1.4401, 1.4404 (AISI 316L), 1.4408
----	--

**Material for shut-off element**

V4	Stainless steel 1.4401, 1.4404 (AISI 316L), 1.4408
----	--

**Sealing material**

T	PTFE reinforced
---	-----------------

# Ball valves VZBC, 2-way, stainless steel, compact design

Technical data



- 2-way ball valve made from stainless steel



- - Ring housing  
DN15 ... DN100
- - Flow rate Kv  
19.4 ... 1,414 m<sup>3</sup>/h

General technical data									
Process valve connection	Ring housing with threaded flange								
Nominal size DN	15	20	25	32	40	50	65	80	100
Valve function	2/2-way								
Design	2-way ball valve								
Sealing principle	Soft								
Actuation type	Mechanical								
Manual override	None								
Switching position display	Slot direction = flow direction								
Direction of flow	Reversible								
Type of mounting	In-line installation								
Mounting position	Any								
Based on standard	EN 1092-1 ISO 5211								
Actuation moment [Nm]	10	13	17	24	35	54	85	117	148
Internal diameter [mm]	15	20	25	32	38	50	64	76	96
Flow rate Kv [m <sup>3</sup> /h]	19.4	45.6	71.5	105	170	275	507	905	1,414
Product weight [g]	1,500	2,100	2,600	3,700	4,400	6,200	10,000	14,400	20,600

Operating and environmental conditions									
Process valve connection	Ring housing with threaded flange								
Nominal size DN	15	20	25	32	40	50	65	80	100
Operating medium	Compressed air to ISO 8573-1:2010 [:-:-]								
Process valve operating medium	Neutral liquids								
	Inert gases								
	Water – no water vapour								
Process valve nominal pressure <sup>1)</sup>	PN 40						PN 16		
Temperature of medium <sup>2)</sup> [°C]	-10 ... 200								
Corrosion resistance class CRC <sup>3)</sup>	3								
CE marking (see declaration of conformity) → www.festo.com	-				To EU Pressure Equipment Directive				

1) PN class to DIN EN 1333

2) As a function of operating pressure → 12

3) Corrosion resistance class CRC 3 to Festo standard FN 940070

High corrosion stress. Outdoor exposure under moderate corrosive conditions. External visible parts with primarily functional requirements for the surface and which are in direct contact with a normal industrial environment.

# Ball valves VZBC, 2-way, stainless steel, compact design

Technical data

Materials	Information on materials	Material number
Housing	High-alloy stainless steel	1.4408
Ball		1.4408, 1.4401
Shaft		1.4401
Seals	Housing	PTFE
	Shaft	PTFE reinforced
Note on materials	RoHS-compliant, contains paint-wetting impairment substances	

## Permissible operating pressure p as a function of temperature of the medium t

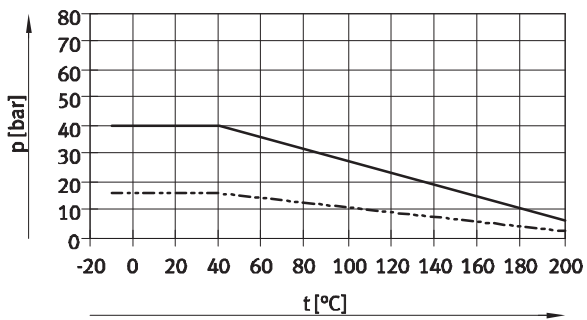

# Ball valves VZBC, 2-way, stainless steel, compact design

Technical data

Dimensions

Download CAD data → [www.festo.com](http://www.festo.com)

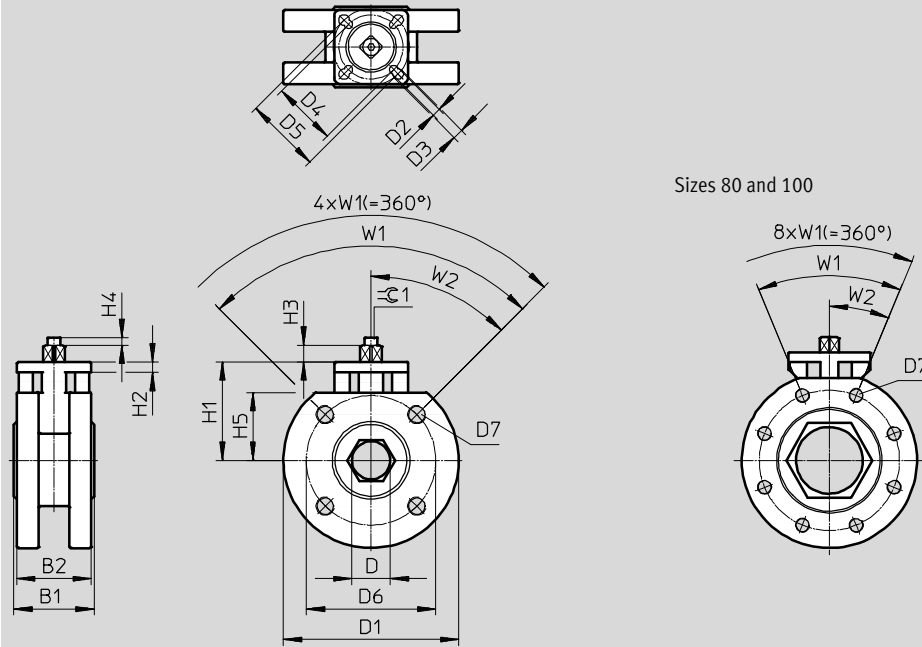

Type	B1	B2	D	D1	D2	D3	D4	D5	D6	D7	H1	H2	H3	H4	H5	⊙ 1
	+1.6		∅	∅	∅	∅	∅	∅	∅				+15 -0.5			-0.1
VZBC-15-FF-40-22-F0304-V4V4T	40	43.5	15	95	6	5.5	36	42	65	M12	60	6.3	7.86	5	34.5	9
VZBC-20-FF-40-22-F0304-V4V4T	44	43.5	20	105	6	5.5	36	42	75	M12	64.3	7	11	5	38.5	9
VZBC-25-FF-40-22-F0405-V4V4T	53	48.5	25	115	5.5	7	42	50	85	M12	64.6	7	11	5	44.6	11
VZBC-32-FF-40-22-F0405-V4V4T	58.4	49.5	32	140	5.5	7	42	50	100	M16	69	7	11	-	51	11
VZBC-40-FF-40-22-F0507-V4V4T	62	62	38	150	7	8.5	50	70	110	M16	76.3	7.2	17	-	55	14
VZBC-50-FF-40-22-F0507-V4V4T	78	70	50	165	7	8.5	50	70	125	M16	85.5	7.2	15.3	-	63	14
VZBC-65-FF-16-22-F07-V4V4T	100	70	64	185	-	9	-	70	145	M16	105	10.6	14	-	73.5	17
VZBC-80-FF-16-22-F07-V4V4T	120	70	76	200	-	9	-	70	160	M16	123	10.6	18	-	94	17
VZBC-100-FF-16-22-F0710-V4V4T	152	96	96	220	9	10.5	70	102	180	M16	132	12.6	15	-	105	17

# Ball valves VZBC, 2-way, stainless steel, compact design

Technical data

Ordering data			
	Process valve connection	Part No.	Type
	Ring housing with threaded flange	1692198	VZBC-15-FF-40-22-F0304-V4V4T
		1692200	VZBC-20-FF-40-22-F0304-V4V4T
		1692201	VZBC-25-FF-40-22-F0405-V4V4T
		1692202	VZBC-32-FF-40-22-F0405-V4V4T
		1692204	VZBC-40-FF-40-22-F0507-V4V4T
		1692206	VZBC-50-FF-40-22-F0507-V4V4T
		1692207	VZBC-65-FF-16-22-F07-V4V4T
		1692208	VZBC-80-FF-16-22-F07-V4V4T
		1692209	VZBC-100-FF-16-22-F0710-V4V4T

# Ball valves VZBC, 2-way, stainless steel, compact design

Accessories

## Hand lever VAOH

Information on materials:

- High-alloy stainless steel
- Free of copper and PTFE
- Contains PWIS (paint-wetting impairment substances)



### Dimensions and ordering data

Download CAD data → [www.festo.com](http://www.festo.com)

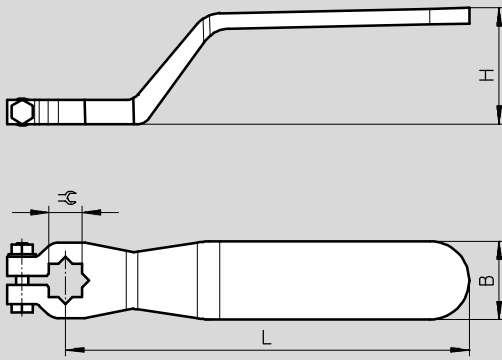

For connection	$\approx$ $\pm 0.5$	L $\pm 10$	H $\pm 5$	B $\pm 5$	Weight [g]	Part No.	Type
DN15 ... DN20	9	120	36	21	100	542702	VAOH-9-H9
DN25 ... DN32	11	140	40	26	200	542703	VAOH-11-H9
DN40 ... DN50	14	180	46	31	300	542704	VAOH-14-H9
DN65 ... DN100	17	240	55	36	450	542705	VAOH-17-H9

# Ball valves VAPB, 2-way, brass

Type codes

VAPB - 1/2 - F - 40 - F03 -

Type	
VAPB	Ball valve

Nominal size to DIN 2999	
1/4	Barrel with female thread Rp1/4
3/8	Barrel with female thread Rp3/8
1/2	Barrel with female thread Rp1/2
3/4	Barrel with female thread Rp3/4
1	Barrel with female thread Rp1
1 1/4	Barrel with female thread Rp1 1/4
1 1/2	Barrel with female thread Rp1 1/2
2	Barrel with female thread Rp2
2 1/2	Barrel with female thread Rp2 1/2

Connection type	
F	Female thread

Process valve nominal pressure PN	
25	PN 25
40	PN 40

Flange connection to ISO 5211	
F03	1 pitch circle diameter of 36 mm
F0304	2 pitch circle diameters of 36 and 42 mm
F0405	2 pitch circle diameters of 42 and 50 mm
F05	1 pitch circle diameter of 50 mm
F07	1 pitch circle diameter of 70 mm

Material	
	Brass



# Ball valves VAPB, 2-way, brass

Technical data



- - Connecting thread  
Rp1/4 ... Rp2 1/2

- - Flow rate Kv  
5.9 ... 535 m<sup>3</sup>/h

- Connecting thread to DIN 2999
- Mounting flange to ISO 5211
- PN class to DIN EN 1333
- Blow-out proof shaft assembled from inside
- Centring attachment for easy automation
- O-ring seal for use with a vacuum



General technical data									
Connection	Rp1/4	Rp3/8	Rp1/2	Rp3/4	Rp1	Rp1 1/4	Rp1 1/2	Rp2	Rp2 1/2
Nominal size DN	15	15	15	20	25	32	40	50	63
Valve function	2/2-way								
Design	2-way ball valve								
Sealing principle	Soft								
Actuation type	Mechanical								
Switching position display	Slot direction = flow direction								
Direction of flow	Reversible								
Type of mounting	In-line installation								
Mounting position	Any								
Working line 1, 2	1/4	3/8	1/2	3/4	1	1 1/4	1 1/2	2	2 1/2
Internal diameter [mm]	15	15	15	20	25	32	40	50	63
Flow rate Kv [m <sup>3</sup> /h]	5.9	9.4	17	41	70	121	200	292	535
Product weight [g]	500	500	400	500	800	1,300	1,900	3,100	3,100

Operating and environmental conditions										
Connection	Rp1/4	Rp3/8	Rp1/2	Rp3/4	Rp1	Rp1 1/4	Rp1 1/2	Rp2	Rp2 1/2	
Operating medium	Compressed air in accordance with ISO 8573-1:2010 [:-:-]									
	Neutral liquids									
	Inert gases									
	Water									
Process valve nominal pressure <sup>1)</sup>	PN 40	PN 40	PN 40	PN 40	PN 40	PN 40	PN 25	PN 25	PN 25	
Temperature of medium [°C]	-20 ... +150									
Breakaway torque at a differential pressure of 0 bar	3.1	3.1	3.1	4.6	6.5	10.8	13.5	20	30	
Breakaway torque at a differential pressure of 10 bar	3.5	3.5	3.5	5.1	7.2	11.9	14.9	22	33	
Breakaway torque at process valve differential pressure PN	5	5	5	6	8.5	15	19	29	45	
Corrosion resistance class CRC <sup>2)</sup>	1									
CE marking (see declaration of conformity) ➔ www.festo.com	-							As per EU Pressure Equipment Directive		

1) PN class to DIN EN 1333

2) Corrosion resistance class CRC 1 to Festo standard FN 940070

Low corrosion stress. For dry indoor applications or transport and storage protection. Also applies to parts behind covers, in the non-visible interior area, and parts which are covered in the application (e.g. drive trunnions).

# Ball valves VAPB, 2-way, brass

Technical data

Materials		Information on materials	Material number
Housing		Nickel-plated brass	CW 617 N
Ball		Brass, hard-chromium plated	Up to Rp1/2 CW 614 N, Rp3/4 and above CW 617 N
Shaft		Nickel-plated brass	CW 614 N
Seals	Housing	PTFE, HNBR	
	Shaft	PTFE	
Note on materials		Contains PWIS (paint-wetting impairment substances), RoHS-compliant	

Torque <sup>1)</sup> [Nm]									
Process valve connection	Rp1/4	Rp3/8	Rp1/2	Rp3/4	Rp1	Rp1 1/4	Rp1 1/2	Rp2	Rp2 1/2
$\Delta p = 0 \text{ bar}$	3.1	3.1	3.1	4.6	6.5	10.8	13.5	20	30
$\Delta p = 10 \text{ bar}$	3.5	3.5	3.5	5.1	7.2	11.9	14.9	22	33
$\Delta p = pN$	5	5	5	6	8.5	15	19	29	45

1) Torque required for actuating the ball valve

## Permissible operating pressure p as a function of temperature of the medium t

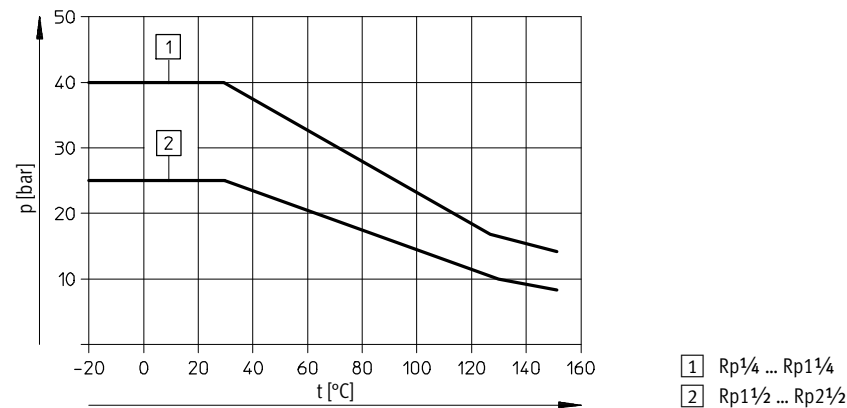

# Ball valves VAPB, 2-way, brass

Technical data

FESTO

## Dimensions

Download CAD data → [www.festo.com](http://www.festo.com)

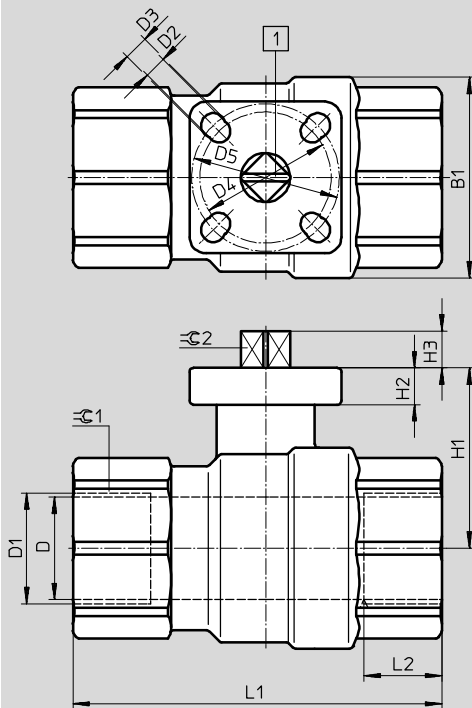

Note  
Switching position display: the slot direction **1** corresponds to the flow direction.

Process valve connection D1 <sup>1)</sup>	B1	D ∅ ±0.15	D2 ∅	D3 ∅	D4 ∅	D5 ∅	H1	H2	H3	L1	L2	⊖ 1	⊖ 2
Rp1/4	35	15	5.5	–	36	–	40	9	9	75	15	26	9
Rp3/8	35	15	5.5	–	36	–	40	9	9	75	15	26	9
Rp1/2	35	15	5.5	–	36	–	40	9	9	75	15	26	9
Rp3/4	45	20	5.5	–	36	–	45	9	9	80	16	32	9
Rp1	55	25	5.5	–	36	42	45	9	9	90	19	41	9
Rp1 1/4	65	32	5.5	6.5	42	50	60	10	11	110	21	50	11
Rp1 1/2	75	40	5.5	6.5	42	50	65	10	11	120	21	55	11
Rp2	90	50	6.5	–	50	–	75	12	14	140	25	70	14
Rp2 1/2	110	65	8.5	–	70	–	85	10	15.5	143	24	83	14

1) Cylindrical barrel with female thread to DIN 2999

## Ordering data

Design	Process valve connection <sup>1)</sup>	Part No.	Type
	Rp1/4	534302	VAPB-1/4-F-40-F03
	Rp3/8	534303	VAPB-3/8-F-40-F03
	Rp1/2	534304	VAPB-1/2-F-40-F03
	Rp3/4	534305	VAPB-3/4-F-40-F03
	Rp1	534306	VAPB-1-F-40-F0304
	Rp1 1/4	534307	VAPB-1 1/4-F-40-F0405
	Rp1 1/2	534308	VAPB-1 1/2-F-25-F0405
	Rp2	534309	VAPB-2-F-25-F05
Rp2 1/2	534310	VAPB-2 1/2-F-25-F07	

1) Cylindrical barrel with female thread to DIN 2999

# Ball valves VAPB, 2-way, brass

Accessories

FESTO

## Hand lever VAOH

Information on materials:

- High-alloy stainless steel
- Free of copper and PTFE
- Contains PWIS (paint-wetting impairment substances)



### Dimensions and ordering data

Download CAD data → [www.festo.com](http://www.festo.com)

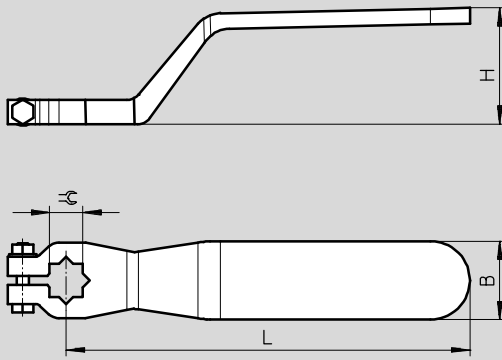

For connection	$\approx \text{C}$ $\pm 0.5$	L $\pm 10$	H $\pm 5$	B $\pm 5$	Weight [g]	Part No.	Type
Rp $\frac{1}{4}$ ... Rp1	9	120	36	21	100	542702	VAOH-9-H9
Rp $1\frac{1}{4}$ ... Rp $1\frac{1}{2}$	11	140	40	26	200	542703	VAOH-11-H9
Rp2 ... Rp $2\frac{1}{2}$	14	180	46	31	300	542704	VAOH-14-H9

# Ball valves VZBA, 3-way, stainless steel

Type codes

VZBA - 1/4 - G G G - 63 - 32T - F0304 - V4 V4 T

**Type**

VZBA	Ball valve
------	------------

**Nominal size DN**

1/4	DN8
3/8	DN10
1/2	DN15
3/4	DN20
1	DN25
1 1/4	DN32
1 1/2	DN40
2	DN50

**Connection type 1**

G	Pipe thread to EN 10226-1
---	---------------------------

**Connection type 2**

G	Pipe thread to EN 10226-1
---	---------------------------

**Connection type 3**

G	Pipe thread to EN 10226-1
---	---------------------------

**Process valve nominal pressure PN**

63	63 bar
----	--------

**Directional control function**

32T	3/2-way, T-shaped hole
32L	3/2-way, L-shaped hole

**Flange connection to ISO 5211**

F0304	2 pitch circle diameters of 36 mm and 42 mm
F0405	2 pitch circle diameters of 42 mm and 50 mm
F0507	2 pitch circle diameters of 50 mm and 70 mm

**Housing material**

V4	Stainless steel 1.4401, 1.4404 (AISI 316L), 1.4408
----	--

**Material for shut-off element**

V4	Stainless steel 1.4401, 1.4404 (AISI 316L), 1.4408
----	--

**Sealing material**

T	PTFE reinforced
---	-----------------

# Ball valves VZBA, 3-way, stainless steel

FESTO

Technical data

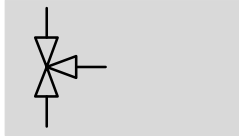

- Mounting flange to ISO 5211
- PN class to DIN EN 1333



- - Connecting thread  
Rp $\frac{1}{4}$  ... Rp2

- - Flow rate Kv  
4.5 ... 100 m<sup>3</sup>/h

General technical data		Rp $\frac{1}{4}$	Rp $\frac{3}{8}$	Rp $\frac{1}{2}$	Rp $\frac{3}{4}$	Rp1	Rp1 $\frac{1}{4}$	Rp1 $\frac{1}{2}$	Rp2
Process valve connection		Rp $\frac{1}{4}$	Rp $\frac{3}{8}$	Rp $\frac{1}{2}$	Rp $\frac{3}{4}$	Rp1	Rp1 $\frac{1}{4}$	Rp1 $\frac{1}{2}$	Rp2
Nominal size DN		8	10	15	20	25	32	40	50
Valve function		3/2-way							
Design		3-way ball valve							
Sealing principle		Soft							
Actuation type		Mechanical							
Manual override		None							
Switching position display		Slot direction = flow direction							
Direction of flow		Reversible							
Type of mounting		In-line installation							
Mounting position		Any							
Based on standard		EN 10226-1 ISO 5211							
Actuation moment	[Nm]	13	13	13	18	22	35	42	68
Internal diameter	[mm]	11.6	12.7	12.7	16	20	25.4	31.8	38.1
Flow rate Kv	Type L <sup>1)</sup> [m <sup>3</sup> /h]	4.5	4.5	4.7	5.1	11.8	19.6	33.2	53.7
	Type T <sup>2)</sup> [m <sup>3</sup> /h]	8	8	8.3	8.3	22.4	36.5	62	100
	Type T <sup>3)</sup> [m <sup>3</sup> /h]	4.5	4.5	4.8	4.8	10.9	18	30	48.8
Flow rate tolerance Kv	[%]	± 20							
Product weight	[g]	700	700	700	1,000	1,600	2,800	3,800	7,400

- 1) Ball with L-shaped hole
- 2) Ball with T-shaped hole, straight flow
- 3) Ball with T-shaped hole, flow around corner

Operating and environmental conditions		Rp $\frac{1}{4}$	Rp $\frac{3}{8}$	Rp $\frac{1}{2}$	Rp $\frac{3}{4}$	Rp1	Rp1 $\frac{1}{4}$	Rp1 $\frac{1}{2}$	Rp2
Process valve connection		Rp $\frac{1}{4}$	Rp $\frac{3}{8}$	Rp $\frac{1}{2}$	Rp $\frac{3}{4}$	Rp1	Rp1 $\frac{1}{4}$	Rp1 $\frac{1}{2}$	Rp2
Operating medium		Compressed air to ISO 8573-1:2010 [-:-:-]							
		Neutral liquids							
		Inert gases							
		Water – no water vapour							
Process valve nominal pressure		PN 63							
Temperature of medium	[°C]	-10 ... +200							
Corrosion resistance class CRC <sup>1)</sup>		3							
CE marking (see declaration of conformity)		-							To EU Pressure Equipment Directive
→ <a href="http://www.festo.com">www.festo.com</a>									

- 1) Corrosion resistance class CRC 3 to Festo standard FN 940070  
High corrosion stress. Outdoor exposure under moderate corrosive conditions. External visible parts with primarily functional requirements for the surface and which are in direct contact with a normal industrial environment.

# Ball valves VZBA, 3-way, stainless steel

Technical data

Materials		Material number
Housing, ball	High-alloy stainless steel	1.4408, 1.4401
Shaft	High-alloy stainless steel	1.4401
Seals	PTFE reinforced	-
Note on materials	Contains PWIS (paint-wetting impairment substances), RoHS-compliant	

Permissible operating pressure p as a function of temperature of the medium t

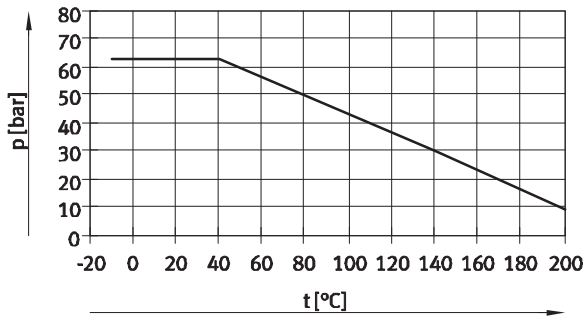

# Ball valves VZBA, 3-way, stainless steel

Technical data

FESTO

## Dimensions

Download CAD data → [www.festo.com](http://www.festo.com)

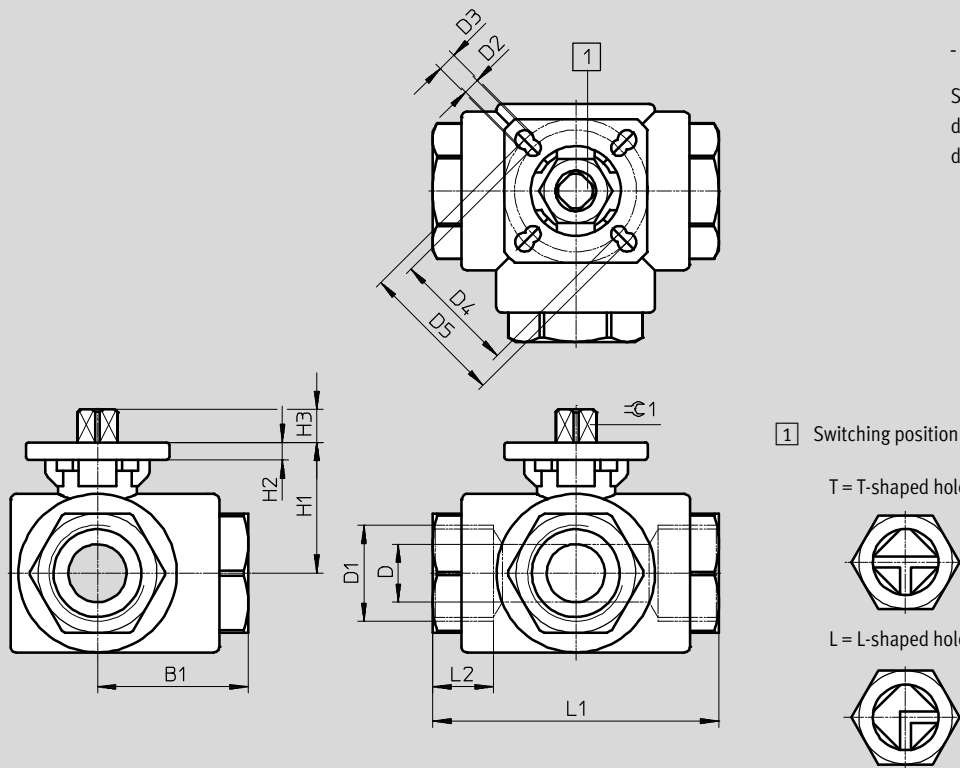

Note

Switching position display: the slot direction corresponds to the flow direction.

1 Switching position display

T = T-shaped hole

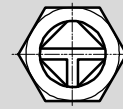

L = L-shaped hole

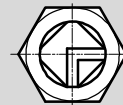

Process valve connection D1 <sup>1)</sup>	D ∅ ±0.15	D1	D2 ∅	D3 ∅	D4 ∅	D5 ∅	H1	H2 ±1	H3	L1 ±1	L2	B1 ±2	±0.1
VZBA-1/4"-GGG-63-32L-F0304-V4V4T	11.6	Rp1/4	5.5	5.5	36	42	35.9	6	7.4	80	15	40	9
VZBA-1/4"-GGG-63-32T-F0304-V4V4T													
VZBA-3/8"-GGG-63-32L-F0304-V4V4T	12.7	Rp3/8	5.5	5.5	36	42	35.9	6	7.4	80	18	40	9
VZBA-3/8"-GGG-63-32T-F0304-V4V4T													
VZBA-1/2"-GGG-63-32L-F0304-V4V4T	12.7	Rp1/2	5.5	5.5	36	42	35.9	6	7.4	80	17.5	40	9
VZBA-1/2"-GGG-63-32T-F0304-V4V4T													
VZBA-3/4"-GGG-63-32L-F0405-V4V4T	16	Rp3/4	5.5	6.5	42	50	40.9	6	12.8	87.5	20	43.75	11
VZBA-3/4"-GGG-63-32T-F0405-V4V4T													
VZBA-1"-GGG-63-32L-F0405-V4V4T	20	Rp1	5.5	6.5	42	50	45.15	6	11.4	100	21	50	11
VZBA-1"-GGG-63-32T-F0405-V4V4T													
VZBA-1 1/4"-GGG-63-32L-F0405-V4V4T	25.4	Rp1 1/4	5.5	6.5	42	50	51	6	12.6	123	21	61.5	11
VZBA-1 1/4"-GGG-63-32T-F0405-V4V4T													
VZBA-1 1/2"-GGG-63-32L-F0405-V4V4T	31.8	Rp1 1/2	5.5	6.5	42	50	55.5	6	12.6	142.2	23	71.1	11
VZBA-1 1/2"-GGG-63-32T-F0405-V4V4T													
VZBA-2"-GGG-63-32L-F0507-V4V4T	38.1	Rp2	6.5	8.5	50	70	66	6	14.3	170.6	26	85.3	14
VZBA-2"-GGG-63-32T-F0507-V4V4T													



# Ball valves VZBA, 3-way, stainless steel

Technical data

Ordering data					
Design	Process valve connection <sup>1)</sup>	L-shaped ball valve		T-shaped ball valve	
		Part No.	Type	Part No.	Type
	Rp $\frac{1}{4}$	1692210	VZBA-1/4-GGG-63-32L-F0304-V4V4T	1692220	VZBA-1/4-GGG-63-32T-F0304-V4V4T
	Rp $\frac{3}{8}$	1692211	VZBA-3/8-GGG-63-32L-F0304-V4V4T	1692221	VZBA-3/8-GGG-63-32T-F0304-V4V4T
	Rp $\frac{1}{2}$	1692212	VZBA-1/2-GGG-63-32L-F0304-V4V4T	1692224	VZBA-1/2-GGG-63-32T-F0304-V4V4T
	Rp $\frac{3}{4}$	1692214	VZBA-3/4-GGG-63-32L-F0405-V4V4T	1692226	VZBA-3/4-GGG-63-32T-F0405-V4V4T
	Rp1	1692215	VZBA-1-GGG-63-32L-F0405-V4V4T	1692227	VZBA-1-GGG-63-32T-F0405-V4V4T
	Rp1 $\frac{1}{4}$	1692217	VZBA-11/4-GGG-63-32L-F0405-V4V4T	1692228	VZBA-11/4-GGG-63-32T-F0405-V4V4T
	Rp1 $\frac{1}{2}$	1692218	VZBA-11/2-GGG-63-32L-F0405-V4V4T	1692229	VZBA-11/2-GGG-63-32T-F0405-V4V4T
	Rp2	1692219	VZBA-2-GGG-63-32L-F0507-V4V4T	1692230	VZBA-2-GGG-63-32T-F0507-V4V4T

1) Cylindrical barrel with female thread to EN 10226-1 (previously DIN 2999)

# Ball valves VZBA, 3-way, stainless steel

Accessories

FESTO

## Hand lever VAOH

Information on materials:

- High-alloy stainless steel
- Free of copper and PTFE
- Contains PWIS (paint-wetting impairment substances)



### Dimensions and ordering data

Download CAD data → [www.festo.com](http://www.festo.com)

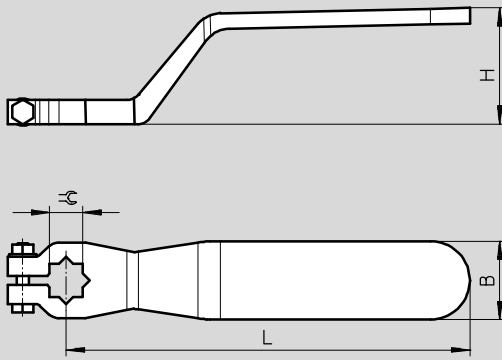

For connection	$\approx \text{C}$ $\pm 0.5$	L $\pm 10$	H $\pm 5$	B $\pm 5$	Weight [g]	Part No.	Type
Rp $\frac{1}{4}$ ... Rp $\frac{1}{2}$	9	120	36	21	100	542702	VAOH-9-H9
Rp $\frac{3}{4}$ ... Rp $1\frac{1}{2}$	11	140	40	26	200	542703	VAOH-11-H9
Rp2	14	180	46	31	300	542704	VAOH-14-H9

## Product Range and Company Overview

### A Complete Suite and Company Overview

Our experienced engineers provide complete support at every stage of your development process, including: conceptualization, analysis, engineering, design, assembly, documentation, validation, and production.



**Custom Automation Components**  
Complete custom engineered solutions



**Custom Control Cabinets**  
Comprehensive engineering support and on-site services



**Complete Systems**  
Shipment, stocking and storage services

### The Broadest Range of Automation Components

With a comprehensive line of more than 30,000 automation components, Festo is capable of solving the most complex automation requirements.



**Electromechanical**  
Electromechanical actuators, motors, controllers & drivers



**Pneumatics**  
Pneumatic linear and rotary actuators, valves, and air supply



**PLCs and I/O Devices**  
PLC's, operator interfaces, sensors and I/O devices

### Supporting Advanced Automation... As No One Else Can!

Festo is a leading global manufacturer of pneumatic and electromechanical systems, components and controls for industrial automation, with more than 16,000 employees in 60 national headquarters serving more than 180 countries. For more than 80 years, Festo has continuously elevated the state of manufacturing with innovations and optimized motion control solutions that deliver higher performing, more profitable automated manufacturing and processing equipment. Our dedication to the advancement of automation extends beyond technology to the education and development of current and future automation and robotics designers with simulation tools, teaching programs, and on-site services.

### Quality Assurance, ISO 9001 and ISO 14001 Certifications

Festo Corporation is committed to supply all Festo products and services that will meet or exceed our customers' requirements in product quality, delivery, customer service and satisfaction.

To meet this commitment, we strive to ensure a consistent, integrated, and systematic approach to management that will meet or exceed the requirements of the ISO 9001 standard for Quality Management and the ISO 14001 standard for Environmental Management.



© Copyright 2013, Festo Corporation. While every effort is made to ensure that all dimensions and specifications are correct, Festo cannot guarantee that publications are completely free of any error, in particular typing or printing errors. Accordingly, Festo cannot be held responsible for the same. For Liability and Warranty conditions, refer to our "Terms and Conditions of Sale", available from your local Festo office. All rights reserved. No part of this publication may be reproduced, distributed, or transmitted in any form or by any means, electronic, mechanical, photocopying or otherwise, without the prior written permission of Festo. All technical data subject to change according to technical update.



Printed on recycled paper at New Horizon Graphic, Inc., FSC certified as an environmental friendly printing plant.

# Festo North America



**1 Festo Canada  
Headquarters  
Festo Inc.**  
5300 Explorer Drive  
Mississauga, ON  
L4W 5G4

**2 Montréal**  
5600, Trans-Canada  
Pointe-Claire, QC  
H9R 1B6

**3 Québec City**  
2930, rue Watt#117  
Québec, QC  
G1X 4G3



**4 Festo United States  
Headquarters  
Festo Corporation**  
395 Moreland Road  
Hauppauge, NY  
11788

**5 Appleton**  
North 922 Tower View Drive, Suite N  
Greenville, WI  
54942

**7 Detroit**  
1441 West Long Lake Road  
Troy, MI  
48098

**6 Chicago**  
85 W Algonquin - Suite 340  
Arlington Heights, IL  
60005

**8 Silicon Valley**  
4935 Southfront Road, Suite F  
Livermore, CA  
94550

## Festo Regional Contact Center

### Canadian Customers

Commercial Support:  
Tel: 1 877 GO FESTO (1 877 463 3786)  
Fax: 1 877 FX FESTO (1 877 393 3786)  
Email: festo.canada@ca.festo.com

Technical Support:  
Tel: 1 866 GO FESTO (1 866 463 3786)  
Fax: 1 877 FX FESTO (1 877 393 3786)  
Email: technical.support@ca.festo.com

### USA Customers

Commercial Support:  
Tel: 1 800 99 FESTO (1 800 993 3786)  
Fax: 1 800 96 FESTO (1 800 963 3786)  
Email: customer.service@us.festo.com

Technical Support:  
Tel: 1 866 GO FESTO (1 866 463 3786)  
Fax: 1 800 96 FESTO (1 800 963 3786)  
Email: product.support@us.festo.com