

Reversing contactor assembly AC-3, 4 kW/400 V, 110 V DC 3-pole,
Size S00 screw terminal electrical and mechanical interlock



product brand name	SIRIUS
product designation	Reversing contactor assembly
product type designation	3RA23
<ul style="list-style-type: none"> • Manufacturer's article number 1 of the supplied contactor • Manufacturer's article number 2 of the supplied contactor • Manufacturer's article number of the supplied RH assembly kit 	3RT2016-1BB42 3RT2016-1BB42 3RA2913-2AA1

General technical data	
Size of contactor	S00
<ul style="list-style-type: none"> • product extension auxiliary switch 	Yes
insulation voltage	
<ul style="list-style-type: none"> • with degree of pollution 3 at AC rated value 	690 V
surge voltage resistance rated value	6 kV
protection class IP	
<ul style="list-style-type: none"> • on the front 	IP20
Shock resistance at rectangular impulse	
<ul style="list-style-type: none"> • at AC 	6,7g / 5 ms, 4,2g / 10 ms

<ul style="list-style-type: none"> • at DC 	6,7g / 5 ms, 4,2g / 10 ms
Shock resistance with sine pulse	
<ul style="list-style-type: none"> • at AC 	10,5g / 5 ms, 6,6g / 10 ms
<ul style="list-style-type: none"> • at DC 	10,5g / 5 ms, 6,6g / 10 ms
Mechanical service life (switching cycles)	
<ul style="list-style-type: none"> • of contactor typical 	10 000 000
<ul style="list-style-type: none"> • of the contactor with added auxiliary switch block typical 	10 000 000
reference code acc. to DIN EN 81346-2	Q

Ambient conditions

<ul style="list-style-type: none"> • installation altitude at height above sea level maximum 	2 000 m
<ul style="list-style-type: none"> • ambient temperature during operation 	-25 ... +60 °C
<ul style="list-style-type: none"> • ambient temperature during storage 	-55 ... +80 °C

Main circuit

number of poles for main current circuit	3
Number of NO contacts for main contacts	3
Number of NC contacts for main contacts	0
<ul style="list-style-type: none"> • operating voltage at AC-3 rated value maximum 	690 V
<ul style="list-style-type: none"> • <ul style="list-style-type: none"> — operating current at AC-3 at 400 V rated value 	9 A
Operating current	
<ul style="list-style-type: none"> • at 1 current path at DC-1 <ul style="list-style-type: none"> — at 24 V rated value — at 110 V rated value 	20 A 2.1 A
<ul style="list-style-type: none"> • with 2 current paths in series at DC-1 <ul style="list-style-type: none"> — at 24 V rated value — at 110 V rated value 	20 A 12 A
<ul style="list-style-type: none"> • with 3 current paths in series at DC-1 <ul style="list-style-type: none"> — at 24 V rated value — at 110 V rated value 	20 A 20 A
Operating current	
<ul style="list-style-type: none"> • at 1 current path at DC-3 at DC-5 <ul style="list-style-type: none"> — at 24 V rated value — at 110 V rated value 	20 A 0.15 A
<ul style="list-style-type: none"> • with 2 current paths in series at DC-3 at DC-5 <ul style="list-style-type: none"> — at 24 V rated value — at 110 V rated value 	20 A 0.35 A
<ul style="list-style-type: none"> • with 3 current paths in series at DC-3 at DC-5 	

— at 24 V rated value	20 A
— at 110 V rated value	20 A
• operating power at AC-3	
— at 400 V rated value	4 kW
— at 500 V rated value	4.5 kW
— at 690 V rated value	5.5 kW
• Operating power at AC-4 at 400 V rated value	4 kW
No-load switching frequency	1 500 1/h
operating frequency at AC-3 maximum	750 1/h

Control circuit/ Control	
Type of voltage of the control supply voltage	DC
Control supply voltage 1	
• at DC rated value	110 V
Closing power of magnet coil at DC	4 W
Holding power of magnet coil at DC	4 W

Auxiliary circuit	
Operating current of auxiliary contacts at AC-12 maximum	10 A
operating current of auxiliary contacts at AC-15	
• at 230 V	6 A
• at 400 V	3 A
operating current of auxiliary contacts at DC-13	
• at 24 V	10 A
• at 60 V	2 A
• at 110 V	1 A
• at 220 V	0.3 A
contact reliability of auxiliary contacts	< 1 error per 100 million operating cycles

UL/CSA ratings	
full-load current (FLA) for three-phase AC motor	
• at 480 V rated value	7.6 A
• at 600 V rated value	9 A
yielded mechanical performance [hp]	
• for single-phase AC motor	
— at 110/120 V rated value	0.33 hp
— at 230 V rated value	1 hp
• for three-phase AC motor	
— at 200/208 V rated value	2 hp
— at 220/230 V rated value	3 hp
— at 460/480 V rated value	5 hp
— at 575/600 V rated value	7.5 hp
contact rating of auxiliary contacts according to UL	A600 / Q600

Short-circuit protection

- Design of the fuse link for short-circuit protection of the main circuit with type of coordination 1 required
- Design of the fuse link for short-circuit protection of the main circuit with type of assignment 2 required
- design of the fuse link for short-circuit protection of the auxiliary switch required

gG NH 3NA, DIAZED 5SB, NEOZED 5SE: 35 A

gG NH 3NA, DIAZED 5SB, NEOZED 5SE: 20 A

fuse gG: 10 A

Installation/ mounting/ dimensions

• mounting position

+/-180° rotation possible on vertical mounting surface; can be tilted forward and backward by +/- 22.5° on vertical mounting surface

• mounting type

screw and snap-on mounting onto 35 mm standard mounting rail

height

68 mm

width

90 mm

depth

73 mm

required spacing

• with side-by-side mounting

— forwards	6 mm
— backwards	0 mm
— upwards	6 mm
— downwards	6 mm
— at the side	6 mm

• for grounded parts

— forwards	6 mm
— backwards	0 mm
— upwards	6 mm
— at the side	6 mm
— downwards	6 mm

• for live parts

— forwards	6 mm
— backwards	0 mm
— upwards	6 mm
— downwards	6 mm
— at the side	6 mm

Connections/ Terminals

type of electrical connection

- for main current circuit
- for auxiliary and control current circuit

screw-type terminals

screw-type terminals

- type of connectable conductor cross-sections for main contacts solid

2x (0.5 ... 1.5 mm²), 2x (0.75 ... 2.5 mm²), 2x 4 mm²

• type of connectable conductor cross-sections for main contacts single or multi-stranded	2x (0,5 ... 1,5 mm ²), 2x (0,75 ... 2,5 mm ²), 2x (0,5 ... 4 mm ²)
• type of connectable conductor cross-sections for main contacts finely stranded with core end processing	2x (0.5 ... 1.5 mm ²), 2x (0.75 ... 2.5 mm ²)
• type of connectable conductor cross-sections at AWG conductors for main contacts	2x (20 ... 16), 2x (18 ... 14)
• type of connectable conductor cross-sections for auxiliary contacts single or multi-stranded	2x (0,5 ... 1,5 mm ²), 2x (0,75 ... 2,5 mm ²)
• type of connectable conductor cross-sections for auxiliary contacts finely stranded with core end processing	2x (0.5 ... 1.5 mm ²), 2x (0.75 ... 2.5 mm ²)
• type of connectable conductor cross-sections at AWG conductors for auxiliary contacts	2x (20 ... 16), 2x (18 ... 14)





Safety related data

B10 value	
• with high demand rate acc. to SN 31920	1 000 000
proportion of dangerous failures	
• with low demand rate acc. to SN 31920	40 %
• with high demand rate acc. to SN 31920	75 %
failure rate [FIT]	
• with low demand rate acc. to SN 31920	100 FIT
T1 value for proof test interval or service life acc. to IEC 61508	20 y



Communication/ Protocol

product function bus communication	Yes
• protocol is supported AS-Interface protocol	No
Product function Control circuit interface with IO link	No

Certificates/ approvals

General Product Approval			Declaration of Conformity	Test Certificates
				Miscellaneous Type Test Certificates/Test Report

Test Certificates	Marine / Shipping				
Special Test Certificate					

Marine / Shipping	other	Railway
	Confirmation	Vibration and Shock
		

Further information

Information- and Downloadcenter (Catalogs, Brochures,...)

<https://www.siemens.com/ic10>

Industry Mall (Online ordering system)

<https://mall.industry.siemens.com/mall/en/en/Catalog/product?mlfb=3RA2316-8XB30-1BF4>

Cax online generator

<http://support.automation.siemens.com/WW/CAXorder/default.aspx?lang=en&mlfb=3RA2316-8XB30-1BF4>

Service&Support (Manuals, Certificates, Characteristics, FAQs,...)

<https://support.industry.siemens.com/cs/ww/en/ps/3RA2316-8XB30-1BF4>

Image database (product images, 2D dimension drawings, 3D models, device circuit diagrams, EPLAN macros, ...)

http://www.automation.siemens.com/bilddb/cax_de.aspx?mlfb=3RA2316-8XB30-1BF4&lang=en

Characteristic: Tripping characteristics, I²t, Let-through current

<https://support.industry.siemens.com/cs/ww/en/ps/3RA2316-8XB30-1BF4/char>

Further characteristics (e.g. electrical endurance, switching frequency)

<http://www.automation.siemens.com/bilddb/index.aspx?view=Search&mlfb=3RA2316-8XB30-1BF4&objecttype=14&gridview=view1>

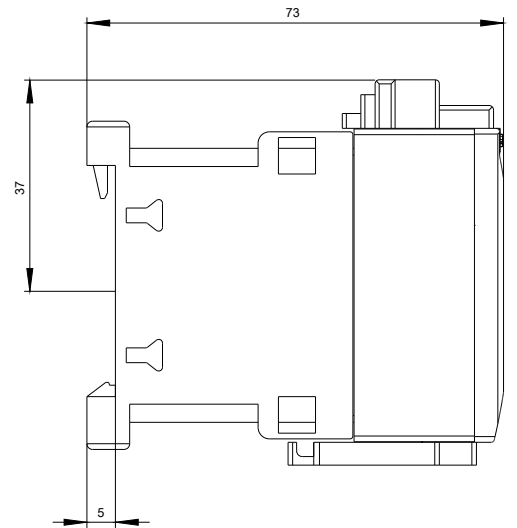
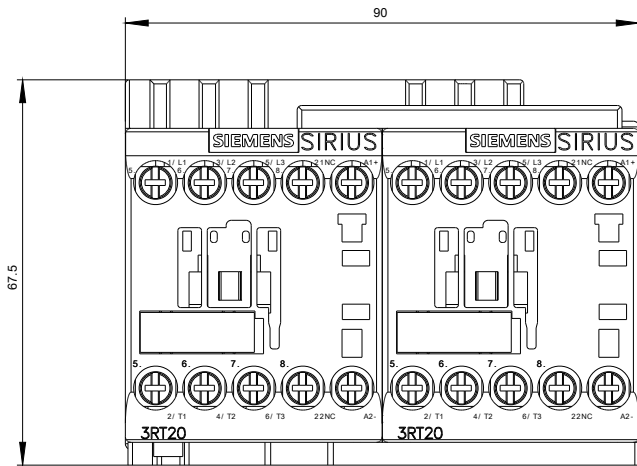

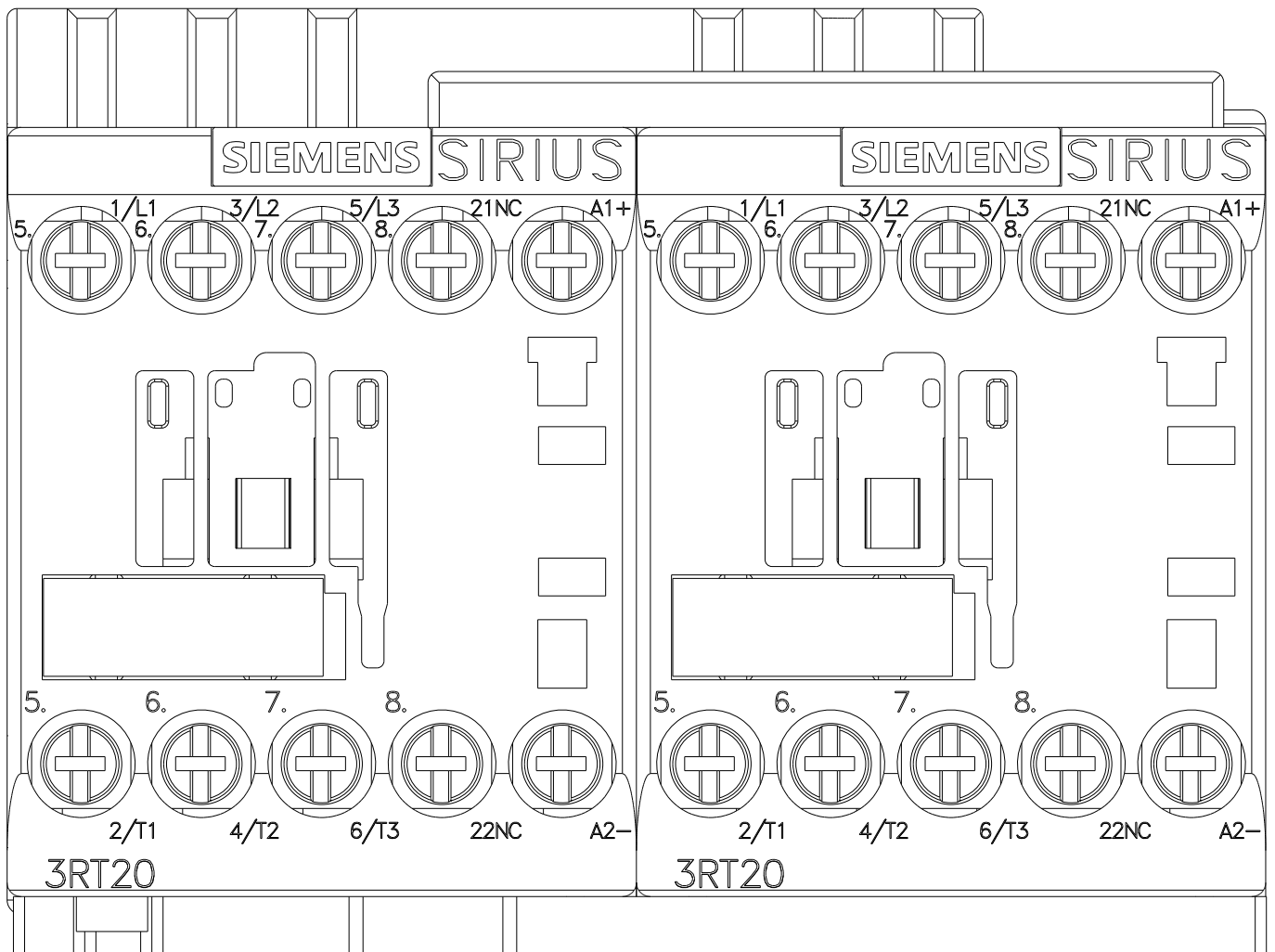

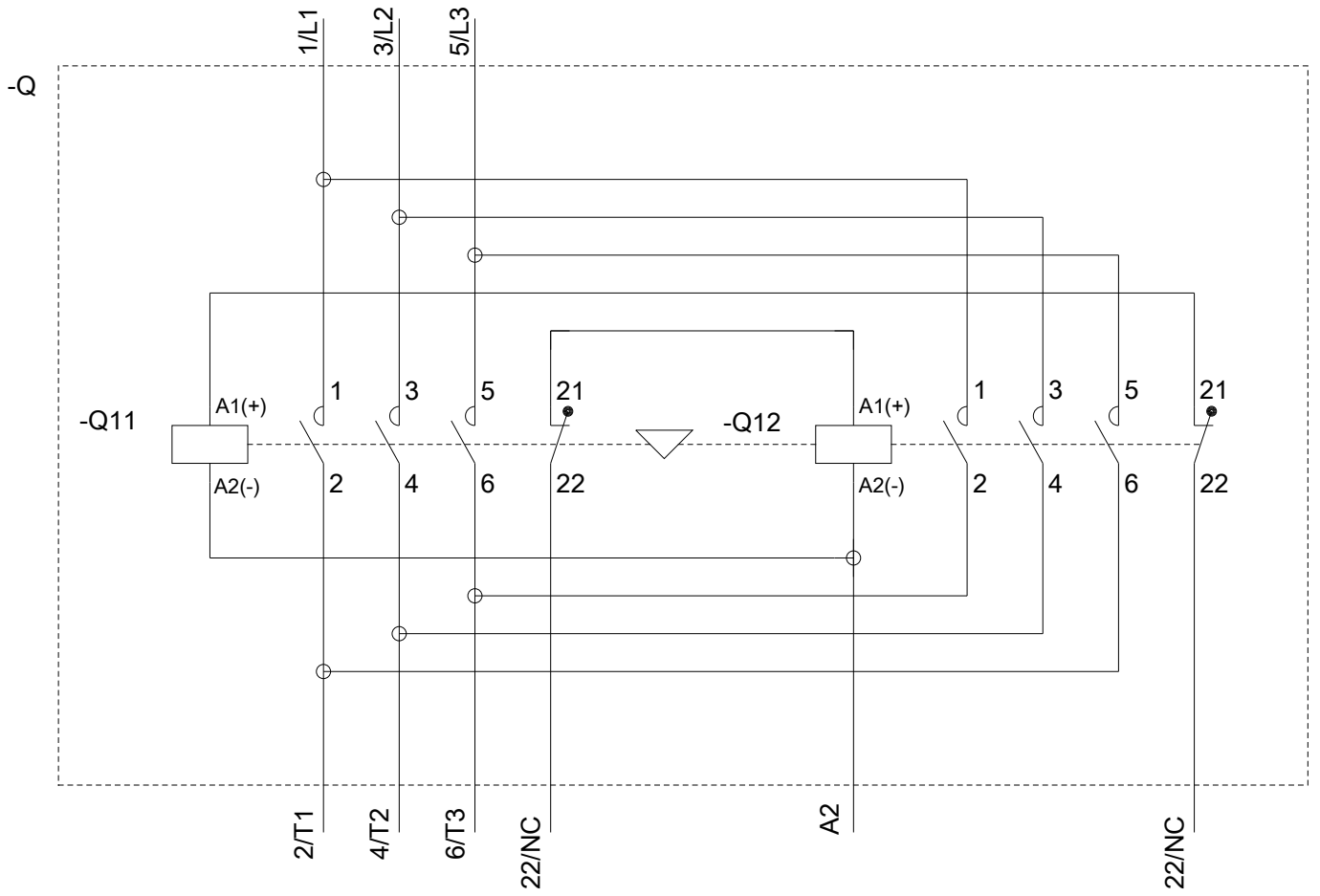

last modified:

08/25/2020