



TPA

The Precision Alliance
4215 Pleasant Road
Fort Mill, SC 29708

1-800-284-9784

Website: www.linearpositioningsystems.com

Is your application throwing you a curve? We've got the solution for you!

CR40 Series Curved Rail Product

The CR40 series curved rail product is designed with the engineer in mind. It allows the most flexibility when trying new ideas. You have the freedom to quickly create and experiment with open and closed loop guide motion systems.

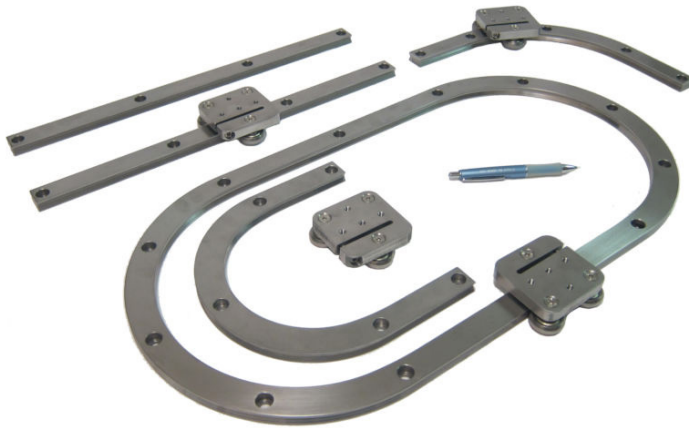
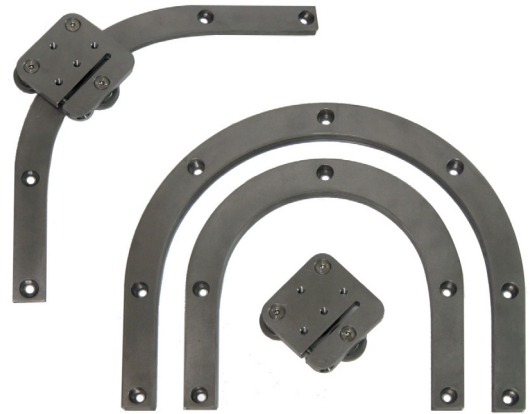

**NEW
PRODUCT !
NOW
AVAILABLE !**

Carriages are designed for smooth rolling motion when mated with our interchangeable straight and curved rail sections.

Rail Section Types:

- Straight
- 90 Degree Turn
- 180 Degree Turn

Each hardened steel rail is designed to allow for mating with any of the CR40 series rail sections. Our special rail geometry provides continuous engagement of the carriage rollers at all positions along the rail.

Carriages:

- Three Cam Roller Bearing Type
- Field Adjustable Preload

Custom curve sections made upon request



Carriages with drilled and tapped holes are available for attaching payload.

Curved rail products can be found in medical lab equipment. Applications include moving samples along a processing line or scanning applications where a camera or other sensing device needs to move in a particular curvilinear fashion. These can also be found in light industrial automation applications such as assembly line part processing.



CR40 Series Curved Rail Product

1-800-284-9784

All rail mounting holes are designed to allow clearance for an M8 socket head cap screw. Starting hole position from each end of a rail section is fixed at 10 mm (0.4 inches).

Carriage Technical Specifications

Load Capacity

Fa - Axial Static = 222.4 N (50 lbs)
Fr - Radial Static = 222.4 N (50 lbs)

Moment Capacity

Mx - Roll = 2.6 N-m (23 in-lbs)
My - Pitch = 6.0 N-m (53 in-lbs)
Mz - Yaw = 3.0 N-m (26.5 in-lbs)

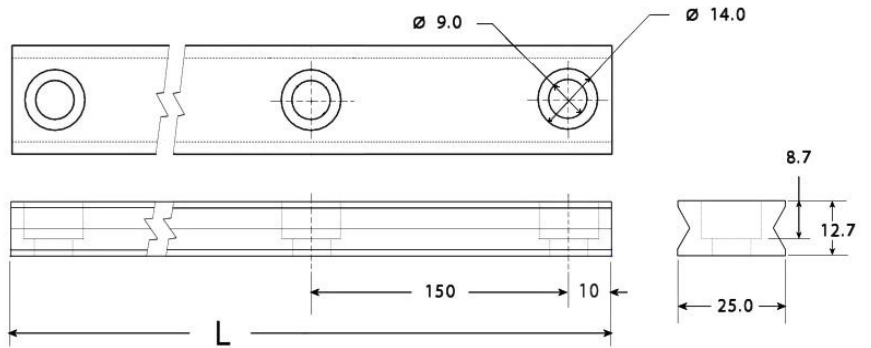
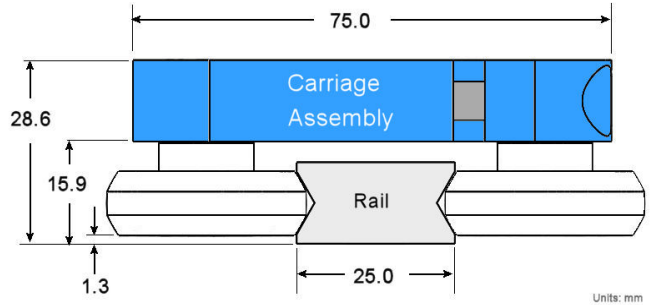
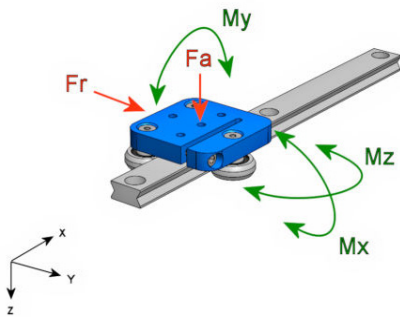

RAIL SECTIONS AVAILABLE NOW

- Straight** - starting at 170mm (6.7 inches) going up to 1220mm (48.0 inches) in length
- 90 degree Turn** - radius starting at 150mm (5.9 inches)
- 180 degree Turn** - radius starting at 100mm (3.9 inches)

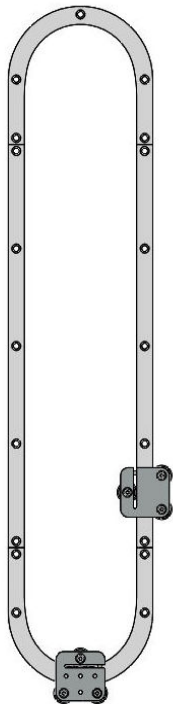

Bill of Materials (Example)

Item	Part Number	Description	Qty
1	CR40-L620-NZ	Straight Section	2
2	CR40-R150-A180-NZ	180 Deg Turn	2
3	CR40-C3-M6-NZ	Carriage	2

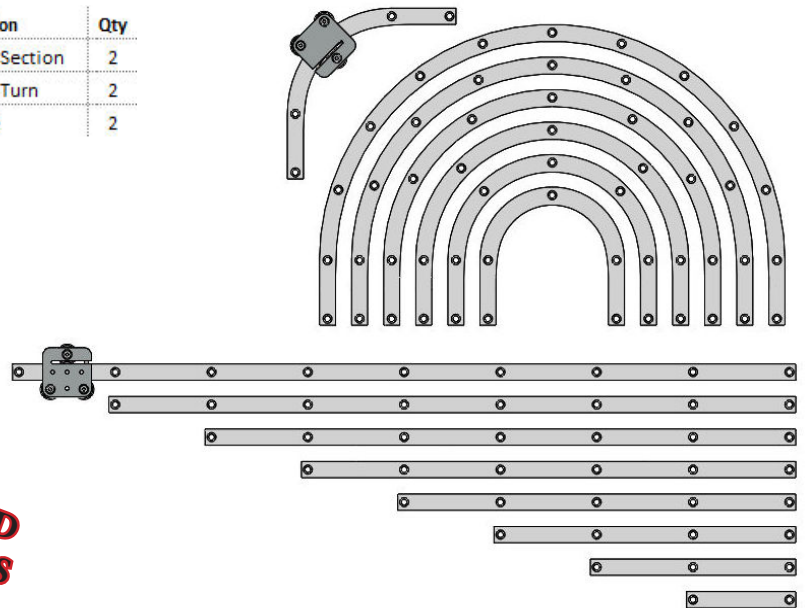

**3D CAD
MODELS
ONLINE**