



go
online

bugaboo bee
user guide

bugaboo[™]
bee

using this guide

The Bugaboo Bee is so simple and easy to use; it won't take long to master.

We have provided a straightforward guide to make sure you and your child get the most out of your Bugaboo experience. Please read it carefully before you use the Bugaboo Bee and keep it for future reference. Your child's safety may be affected if you do not follow these instructions.

This guide is broken into 3 sections. The first contains text, it will introduce you to the Bugaboo Bee and give you an overview of everything you need to know before you start using your new Bugaboo Bee. The second is mainly visual, it will tell you how to set up your Bugaboo Bee and the third gives you clear steps on how to use the many features that make the Bugaboo Bee unique.

in the box

Take a minute to check the contents of your packages.
You should find:

in the first box:

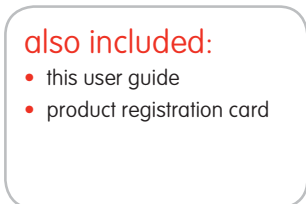
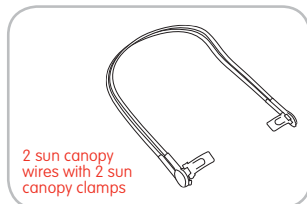
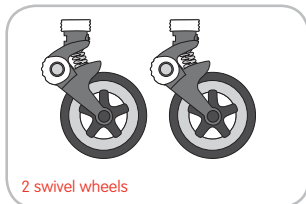
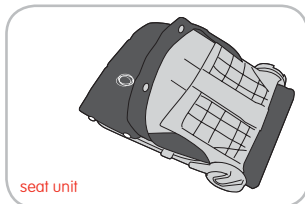
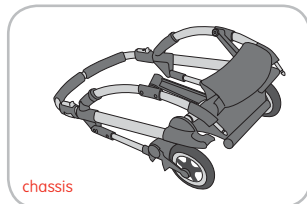

in the second box:

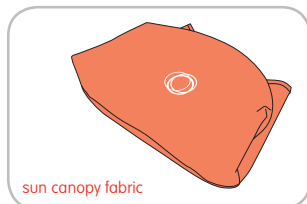

WARNING

Keep plastic and waterproof packaging materials away from babies and children to prevent suffocation.

If anything is missing, please contact your retailer.

© Copyright 2010 000795 rv00 Bugaboo® International BV. The information contained herein is subject to change without notice. Bugaboo® International BV shall not be liable for technical errors or omissions contained herein. The purchased product may differ from the product as described in this user guide. Our most recent user guides can be requested at our Service departments (see 'contact') or at www.bugaboo.com. ™ ® BUGABOO and the Bugaboo logos, FROG, GECKO, CAMELEON and BEE are registered, pending or claimed trademarks of Bugaboo. The Bugaboo pushchairs are patented. The Bugaboo pushchairs are model protected.

contents

introduction

- 3 in the box
- 5 hello from bugaboo
- 6 accessories
- 7 meet the bugaboo bee
- 9 warnings
- 11 important information
- 11 maintenance tips
- 12 cleaning
- 12 replaceable parts
- 13 warranty
- 14 contact

instructions

- 15 **get going**
- 16 attaching the swivel wheels and unfolding
- 17 attaching the seat
- 18 assembling and attaching the sun canopy

- 20 **using your bugaboo bee**
- 21 unfolding – facing the world
- 22 unfolding – facing you
- 24 folding – facing the world
- 25 folding – facing you
- 27 using the brake
- 28 extending the seat depth
- 29 adjusting the backrest position
- 30 adjusting the backrest height
- 31 adjusting the harness height and
securing the harness
- 33 adjusting the sun canopy
- 34 adjusting the handlebar
- 35 using the wrist strap
- 36 locking the swivel wheels
- 37 unlocking the swivel wheels
- 38 turning the seat unit – facing you
- 40 turning the seat unit – facing the world
- 43 attaching the raincover
- 45 removing the underseat basket
- 47 removing the sun canopy
- 50 removing the seat fabric
- 52 reattaching the seat fabric

hello

Welcome to modern mobility and thank you for buying the Bugaboo Bee.

At Bugaboo, we have helped thousands of parents and youngsters discover their world afresh with the help of our cutting-edge technology, our passion for design and our commitment to your freedom.

Our aim is to create a safe and comfortable journey, to help make the big wide world accessible. So we've made the Bugaboo Bee ever adaptable and easily adjustable as your child develops and grows.

For newborns, the baby cocoon is one of the accessories available, to help ensure your baby's comfort. As your child grows, the Bugaboo Bee's reversing seat allows them to face you or face the world.

When your child gets the urge to do a spot of toddling, the Bugaboo Bee easily folds.

Above all, the Bugaboo Bee was designed to be compact, nimble and easy to use. Be spontaneous - use it all the time. The Bugaboo Bee is suitable from birth and designed to accommodate your child from infant to toddler (up to a weight of 17 kg/37.5 lbs).

Please complete the product registration card. This product registration card is for safety purpose only. In the event of a necessary upgrade of your Bugaboo Bee we are able to contact you effectively. You can also register your product online at www.bugaboo.com if you prefer.

The Bugaboo Bee complies with standard for NA: SOR/85 - 379 and ASTM F 833 - 09
All fabric complies with Furniture and Furnishings Fire Safety Regulations.

accessories

We've thought of everything when it comes to accessories:

baby cocoon

Provides extra comfort and head support for newborns.

bugaboo bag

The sleek design and surprisingly functional interior make the Bugaboo Bag a permanent accessory, to be used well beyond childhood.

footmuff

To help keep your child's toes toasty on colder days.

cup holder

An accessible place to store a drink, so you and your child stay hydrated while enjoying your adventure.

parasol

Finding shade on sunny days can be a problem, but with the parasol in place shade is instantly created.

car seat adapters

To attach a car seat to the Bugaboo Bee to keep you and your child truly mobile.

breezy sun canopy

Helps to protect young, sensitive skin from harmful UV rays. It also protects from all sorts of flying bugs.

transport bag

For long trips, nothing could be more useful than a bag to store and protect the Bugaboo Bee.

wheeled board

The wheeled board is a fun place for your older child to stretch their legs without getting tired.

find more information on accessories by visiting www.bugaboo.com

en

meet the bugaboo bee

All the white parts of your Bugaboo Bee are moveable. They're the bits that allow you to adapt and change your Bugaboo Bee.

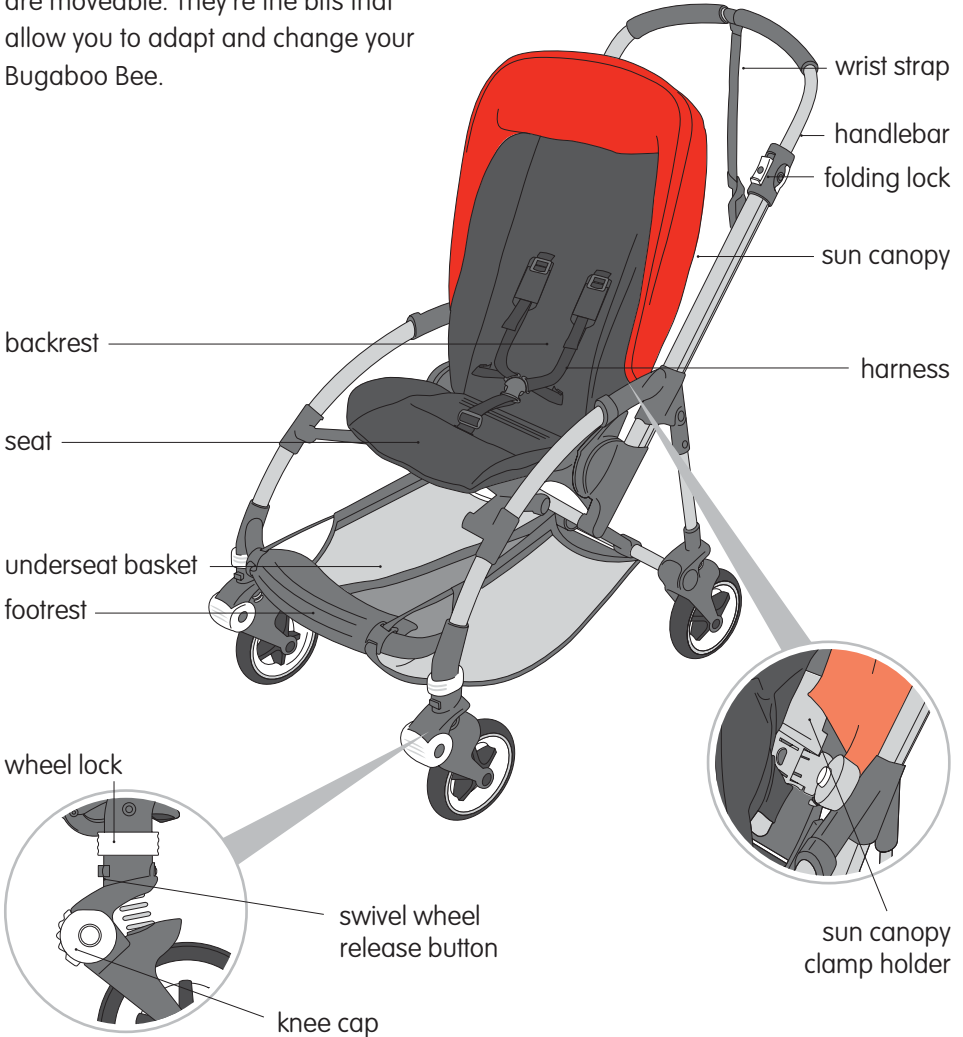

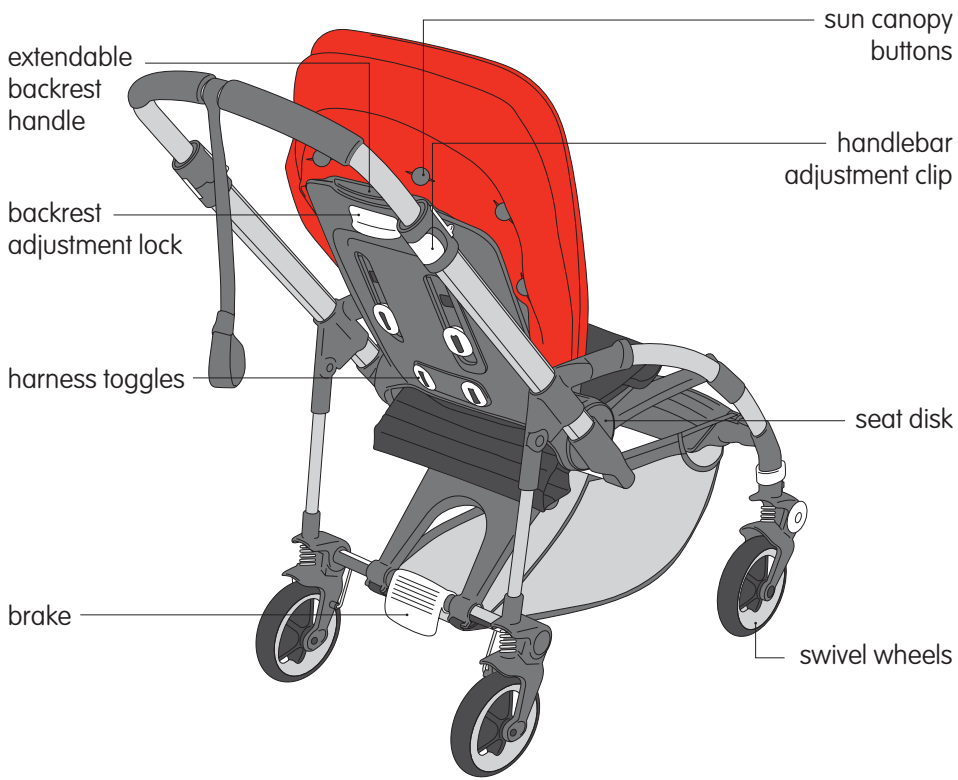

extendable
backrest
handle

backrest
adjustment lock

harness toggles

brake

sun canopy
buttons

handlebar
adjustment clip

seat disk

swivel wheels

WARNINGS

It is crucial that you read and refer to all warnings listed in this section and throughout the guide. These are all relevant and essential for the care and safety of any child when using the Bugaboo Bee. If something isn't clear, please visit us at www.bugaboo.com.

- Do not assemble or use the Bugaboo Bee until you have read the user guide.
- Additional warnings and safety information appear in the assembly, use and accessory sections of this user guide as well as on the Bugaboo Bee itself. These should be reviewed independently.
- Ensure that all the locking devices are engaged before use.
- The wrist strap must be worn at all times.
- Check that the seat unit attachment devices are correctly engaged before use.
- The Bugaboo Bee is suitable from birth and designed to accommodate your child from infant to toddler (up to a weight of 17 kg). Excessive weight may cause a hazardous unstable condition to exist. The product will become unstable if the manufacturer's recommended load is exceeded.
- **DO NOT CARRY EXTRA CHILDREN OR BAGS ON THE BUGABOO BEE.**
- Always use the safety features of your Bugaboo Bee, including locking devices, brake, the harness (when child is in the seat) and the wrist strap attached to the handlebar (see this user guide for additional information). Check and maintain all safety features frequently.
- Children should be harnessed in at all times.

- For any child unable to maintain an unaided sitting position the backrest should only be used in the fully reclined position.
- WHEN ADJUSTING THE BUGABOO BEE, THE CHILD SHOULD BE CLEAR OF MOVING PARTS WHILE MAKING ADJUSTMENTS.
- A child's safety is your responsibility. IT MAY BE DANGEROUS TO LEAVE YOUR CHILD UNATTENDED
- Any load attached to the handlebar affects the stability of the pushchair.
- Take your child out of the Bugaboo Bee when going up or down stairs, escalators or around steep or unstable conditions. Also, take extra care when going up or down a curb or other uneven surfaces.
- Do not allow the Bugaboo Bee to be used as a toy.
- Do not run, jog or skate with the Bugaboo Bee.
- Only use authentic Bugaboo replacement parts and Bugaboo accessories or products approved by Bugaboo for use with the Bugaboo Bee. It is unsafe to use products that are not approved by Bugaboo.
- Always use the crotch strap in combination with the waist belt.
- This vehicle requires regular maintenance by the user.
- The warranty does not cover damage to the Bugaboo Bee caused by overloading, incorrect folding or the use of non-original accessories.

important information

- Check the safety of the Bugaboo Bee before each use. Ensure that the seat fabric, the brake and the safety belts are all working properly, the handlebar is locked and that the seat is fitted correctly to the chassis.
- Check to see if the Bugaboo Bee is damaged. You should ensure that any damaged or worn parts are repaired immediately (see warnings on pages 9-10).
- To ensure complete safety for your child do not use the Bugaboo Bee until any damaged or worn parts have been repaired or replaced.
- The Bugaboo Bee seat unit (no. 591200) should only be used with the Bugaboo Bee chassis (no. 50110). Do not use Bugaboo Bee parts or components with any non-approved pushchair, other device or any other Bugaboo product.
- Do not use the Bugaboo Bee near open flames or other sources of heat. Avoid exposing the Bugaboo Bee to extreme temperatures.
- The Bugaboo Bee is not resistant to saltwater.

maintenance tips

After a few tough months on the streets the Bugaboo Bee may begin to get a bit grubby. To keep a smooth ride, please take care of your Bugaboo Bee. We have some tips for you.

- Clean the Bugaboo Bee chassis and wheels with a soft towel and lukewarm water.
- Use a soft brush to clean sand from the mechanisms and sliding tubes of the frame.
- Clean and lubricate the brake system when you have walked with you Bugaboo Bee on the beach or over gritted surfaces.
- Store your Bugaboo Bee and its accessories in a dry place and leave them unfolded when wet to prevent mould.

For more tips and tricks, check out www.bugaboo.com.

cleaning

We've made the Bugaboo Bee fabric detachable (check page 50) and machine washable.

When washing, don't forget:

- maximum temperature 30°C/85°F (cold wash)
- do not use bleach or any other aggressive detergent
- do not tumble dry
- do not iron
- do not dry clean
- always wash separately
- always check wash label before washing



replaceable parts

We pride ourselves on high quality and high standards. That's why only genuine Bugaboo parts should ever be used on the Bugaboo Bee, or parts that have been approved by Bugaboo.

Visit www.bugaboo.com for an extensive list of your nearest suppliers.

warranty

As the manufacturer, Bugaboo International BV , which has its principal place of business in Amsterdam (hereinafter: "Bugaboo") supplies the [Bugaboo Bee] (hereinafter: "product") under warranty, subject to the following conditions:

1. The warranty period is 24 months, from the date of purchase. The warranty period shall never be extended, even in the event of repairs being made.
2. This guarantee is valid all over the world, except in the United States of America and Canada.
3. The warranty provides a right to repair and specifically not to a product's exchange or return.
4. Bugaboo shall bear the expense and risk of transport from and to the retailer (hereinafter: "the retailer") where you purchased the product, provided the repair is covered by warranty.
5. The warranty may only be invoked if you provide Bugaboo with the following, along with the defective product:
 - a copy of the dated receipt of purchase, and
 - a clear description of the complaint.
6. The warranty is not transferable and may therefore only be invoked by the first owner.
7. The warranty does not affect any statutory rights you may have, for example the right to hold the retailer accountable for defects.

No warranty will be provided in the following circumstances:

- If you have made or arranged for modifications or repairs to be made without written permission first having been received from Bugaboo or the retailer.
- Defects resulting from neglect or an accident and/or from any use or maintenance other than that indicated in the user guide.
- If the serial number has been damaged or removed.
- Damage to the product caused by normal wear.

Important

The product is covered by a 24-month warranty from the date of purchase. In the event of a defect, you are requested to first contact your retailer. If the retailer is unable to repair the defect, you can contact Bugaboo. Keep the user guide and purchase receipt in a safe place.

contact

Before using the Bugaboo Bee, make sure you have the most up-to-date information by filling in your product registration card and sending it to us or, even easier, complete it online at www.bugaboo.com.

We'd like to hear your comments on the Bugaboo Bee. Please write to us at:

bugaboo international bv
po box 1299
1000 bg amsterdam
the netherlands

You can also send an e-mail to service@bugaboo.com or visit our website at www.bugaboo.com

You've met your new Bugaboo Bee, now it's time to get going!

Our visual guide to the Bugaboo Bee will show you how to get the most out of all the great features it has to offer.

Get set up in 'getting going' and then find out all the fantastic things the Bugaboo Bee can do in 'using your Bugaboo Bee'.

Check the top of the page for the parts of the Bugaboo Bee you'll need to use and then follow the steps to try it out.



Go to page 15 to get going

en



en get going

This section will show you how to get your new Bugaboo Bee set up and ready to use. Just check the parts you need at the top of the page and then follow the steps below.

Throughout the user guide, you'll see arrows like this  that show the movement required. Where you see this  you need to listen carefully for a 'click'. If you see this symbol  it means that you're not done yet, the step continues over the page.

Turn the page to get started, we'll have you up and running in no time.

1

attaching the swivel wheels and unfolding

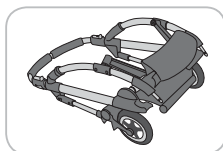

+

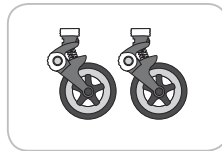

2

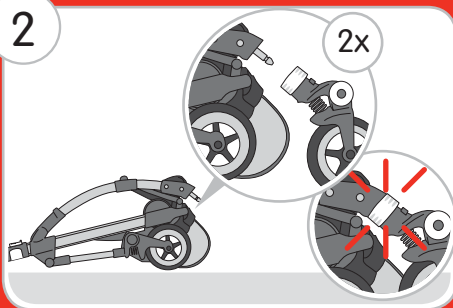

3

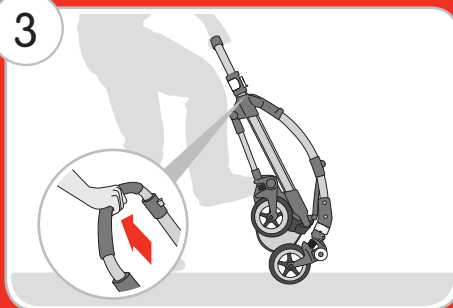

4



5

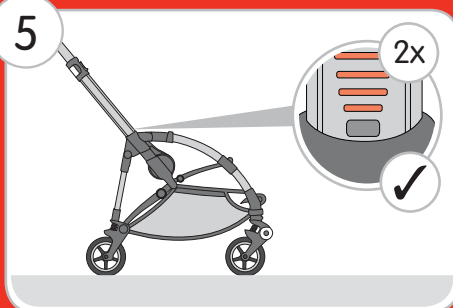

WARNING

In order to be sure that the folding mechanism is in its proper position, at least one of the following must be confirmed:

1. audible 'clicks' heard on both sides.
2. green spots on top of the handlebar completely visible on both sides.

Incorrect folding may damage or break this vehicle.

en

1

attaching the seat

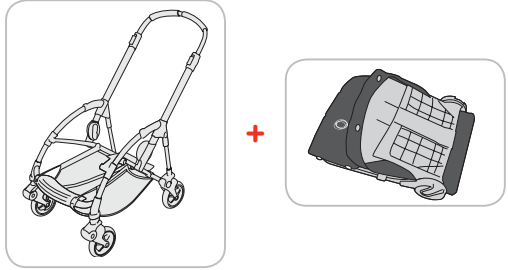

2

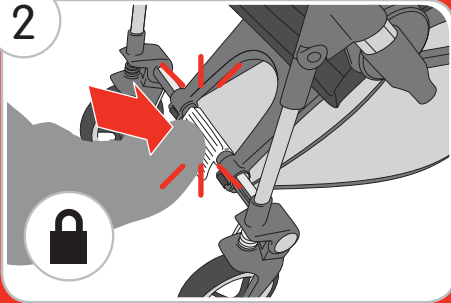

3

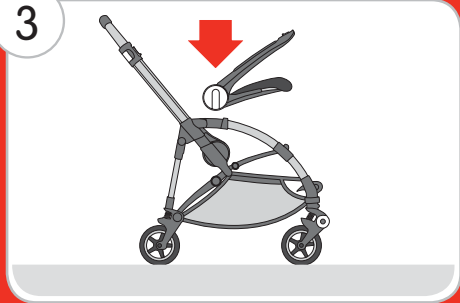

4

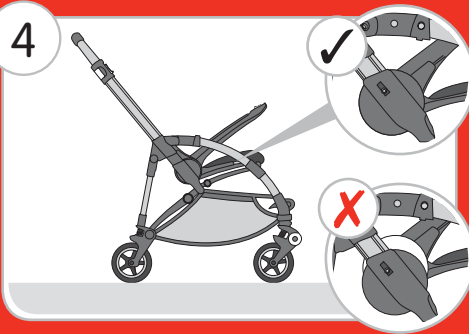

5

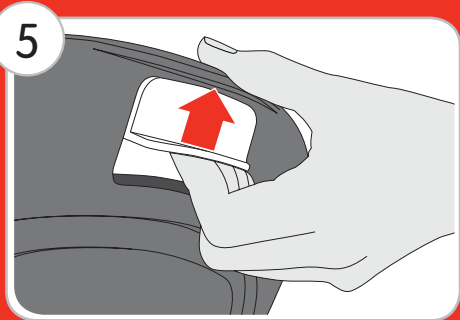

6



1

assembling and attaching the sun canopy

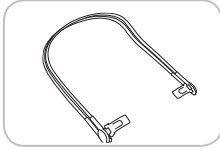

+

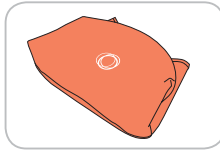

+



2

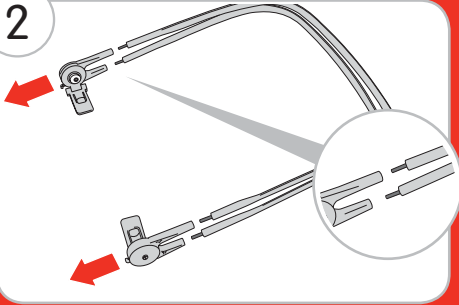

3

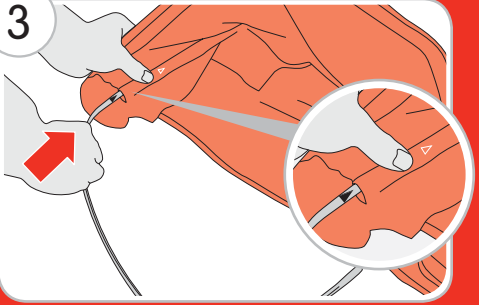

4

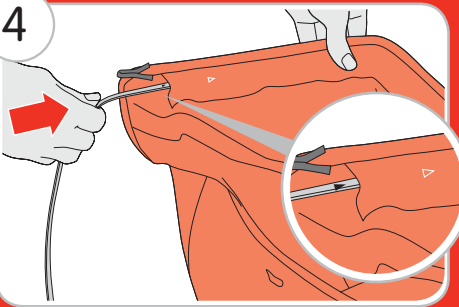

5

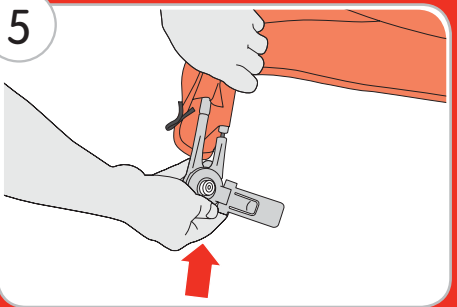

6

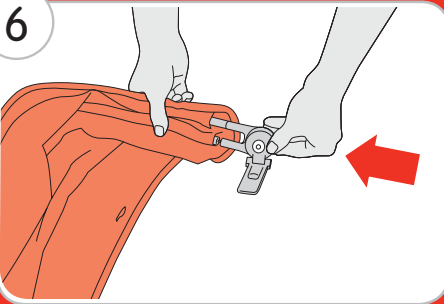

7

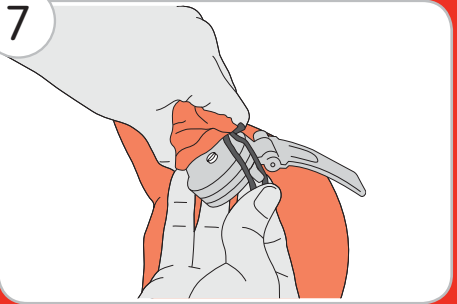

en

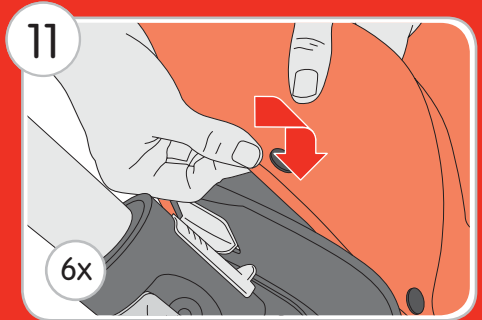
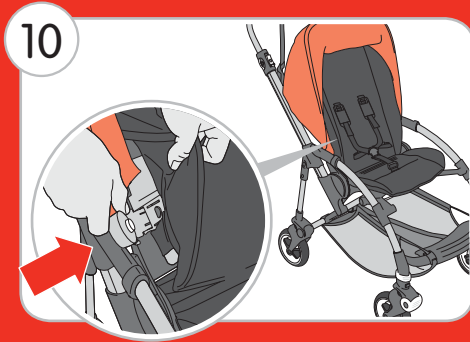
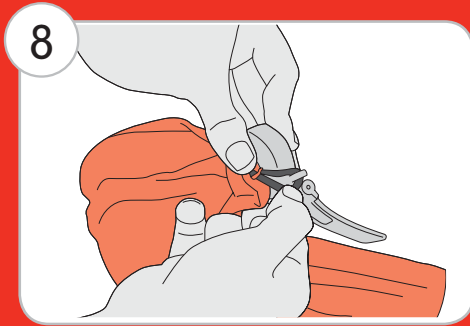



NOTE The sun canopy will fit the Bugaboo Bee for a child with a maximum bottom-to-head length of 59 cm/23.5 inches when the backrest is fully extended.



US

using your bugaboo bee

This section will show you how to use all the features of your Bugaboo Bee. Check the top of the page for which bits of the Bugaboo Bee you'll need to use and then follow the steps below to try it out.

Throughout the user guide, you'll see arrows like this  that show the movement required. Where you see this  you need to listen carefully for a 'click'. If you see this symbol  it means that you're not done yet, the step continues over the page.

Turn the page to begin, you'll be out and about with your Bugaboo Bee in no time.

1

unfolding – facing the world

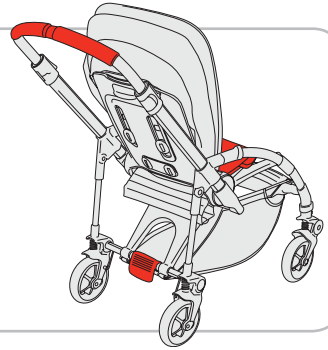

2



3



4

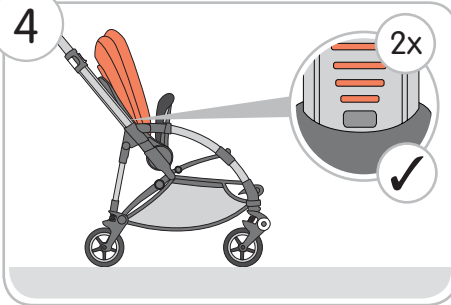

5



WARNING

In order to be sure that the folding mechanism is in its proper position, at least one of the following must be confirmed:

1. audible 'clicks' heard on both sides.
2. green spots on top of the handlebar completely visible on both sides.

Incorrect folding may damage or break this vehicle.

1

unfolding – facing you



2

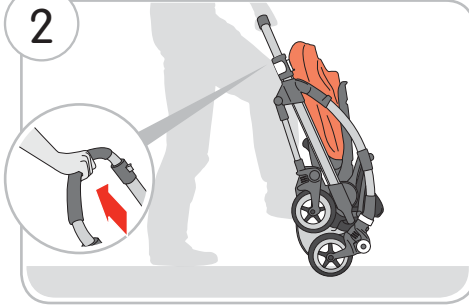

3



4

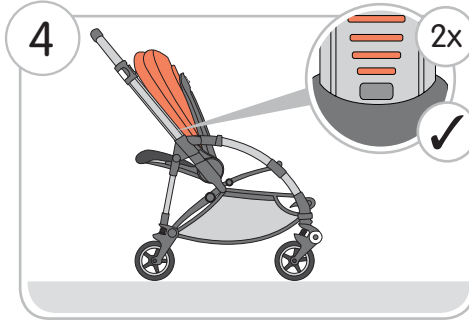

5

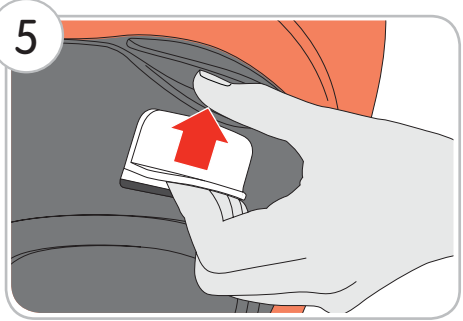

6

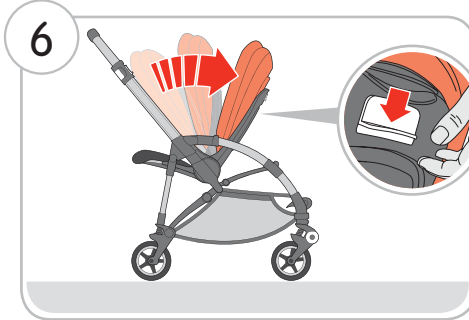



WARNING

In order to be sure that the folding mechanism is in its proper position, at least one of the following must be confirmed:

1. audible 'clicks' heard on both sides.
2. green spots on top of the handlebar completely visible on both sides.

Incorrect folding may damage or break this vehicle.

1

folding – facing the world



2

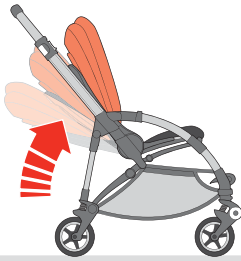

3

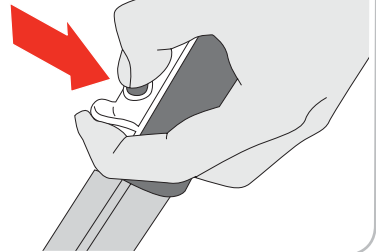

4

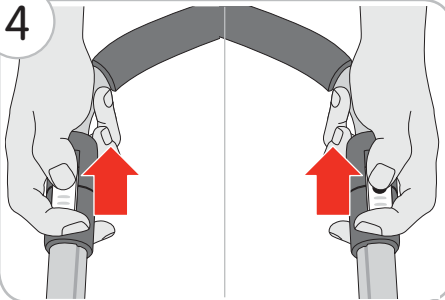

5



WARNING

Care must be taken when folding and unfolding the Bugaboo Bee to prevent fingers from being trapped.

Incorrect folding may damage or break this vehicle.

1

folding – facing you

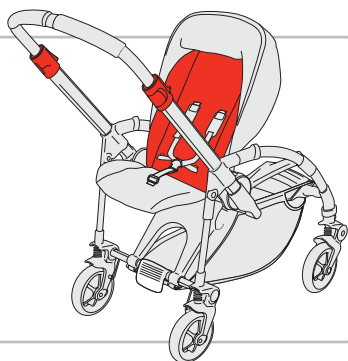

2



3

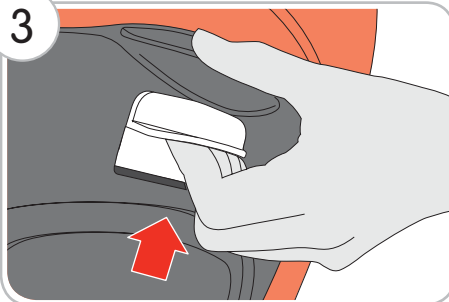

4



5

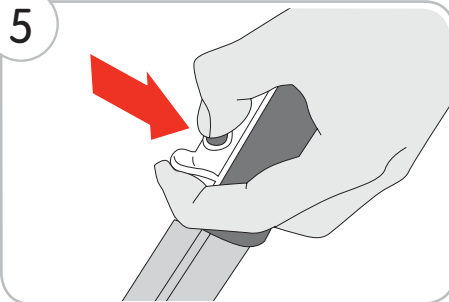

6

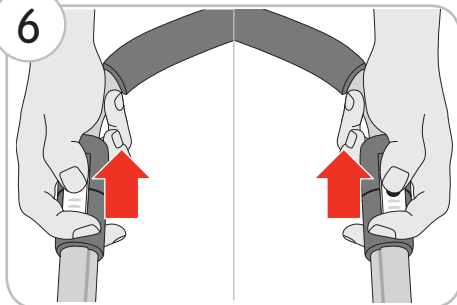

7



en



WARNING

Care must be taken when folding and unfolding the Bugaboo Bee to prevent fingers from being trapped.

Incorrect folding may damage or break this vehicle.

1

using the brake

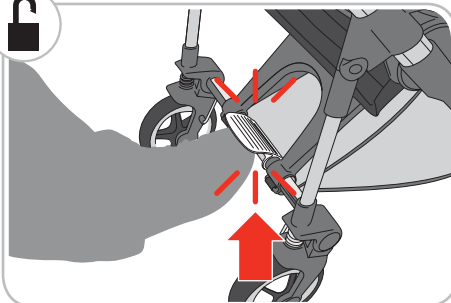
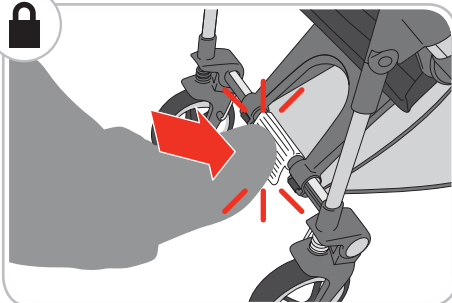

WARNING

The brake is a parking brake only. Apply the brake whenever you park the Bugaboo Bee.

Do not apply the parking brake while the Bugaboo Bee is moving. Only apply the parking brake when the Bugaboo Bee is stationary. The brake pedal must be in its lowest position to lock.

Always apply the brake when positioning or taking out the child.

1

adjusting the seat depth



2

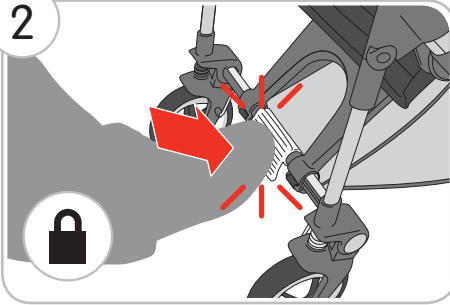

3

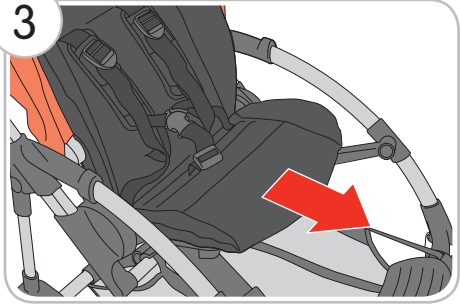

4

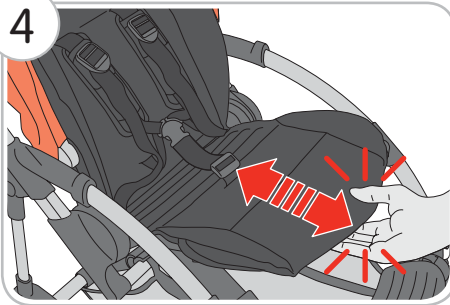

1

adjusting the backrest position



2

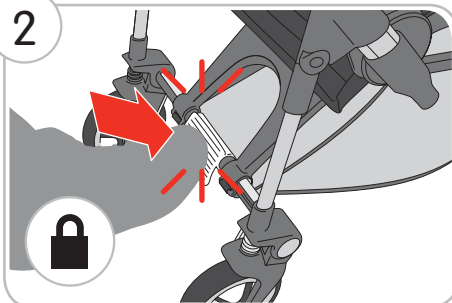

3

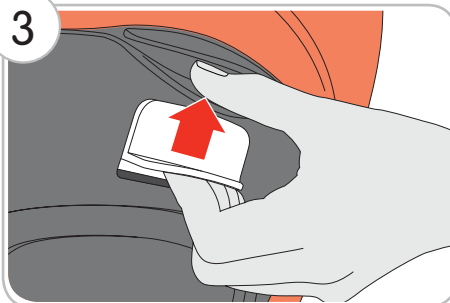

4

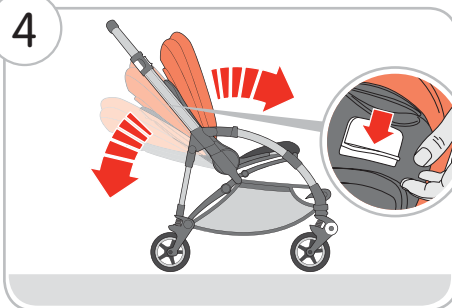

WARNING

For any child unable to maintain an unaided sitting position the backrest should only be used in the most reclined position.

1

adjusting the backrest height



2

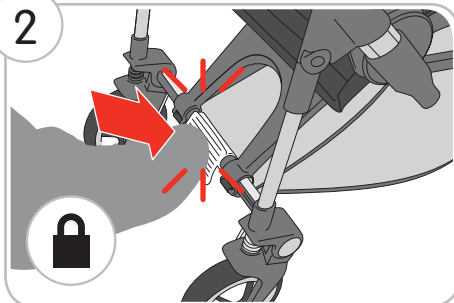

3

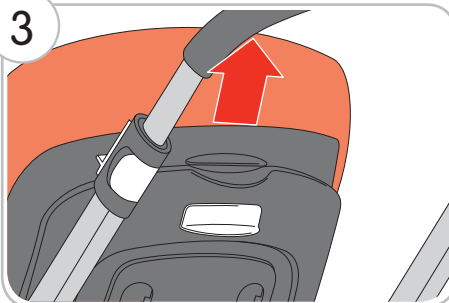

4

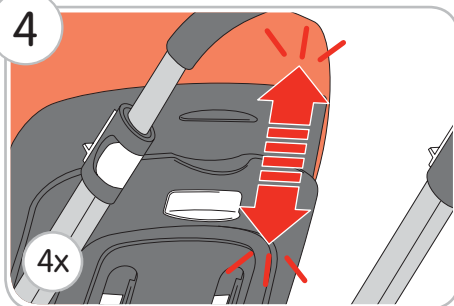

1

adjusting the harness height
and securing the harness



2

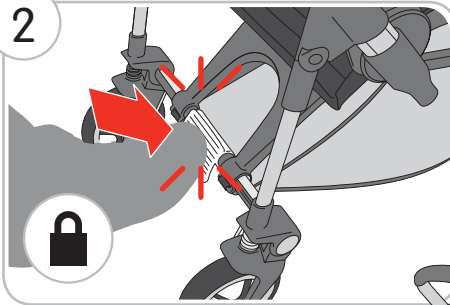

3

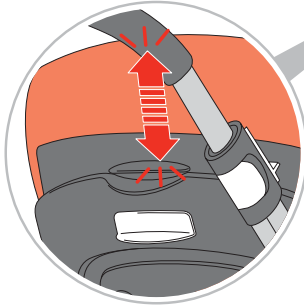
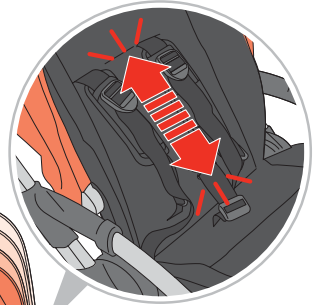

4x

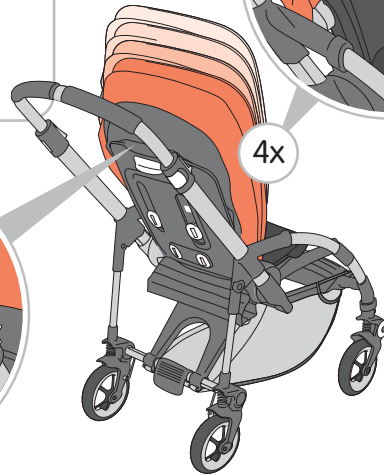

4

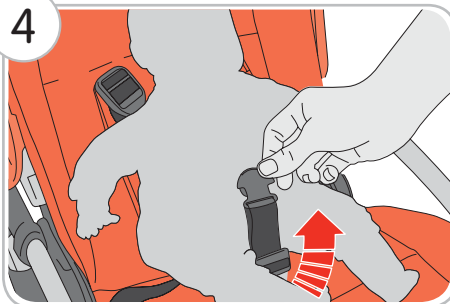

5

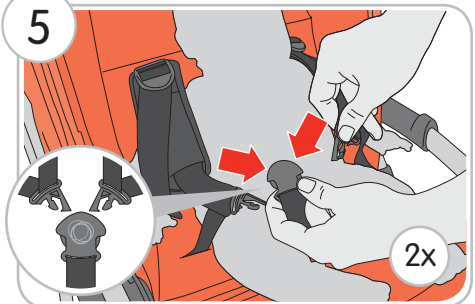

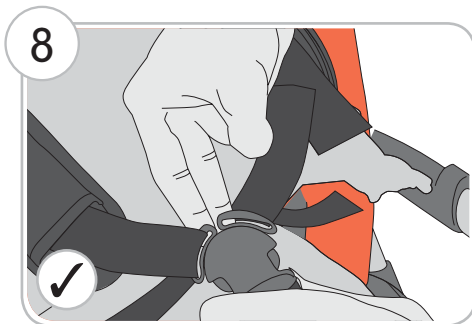
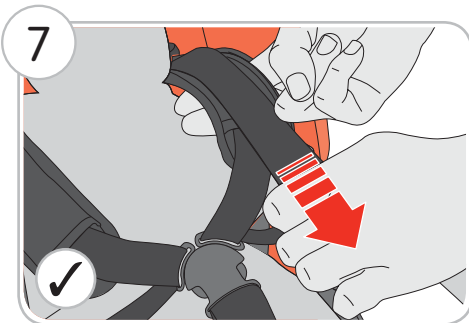
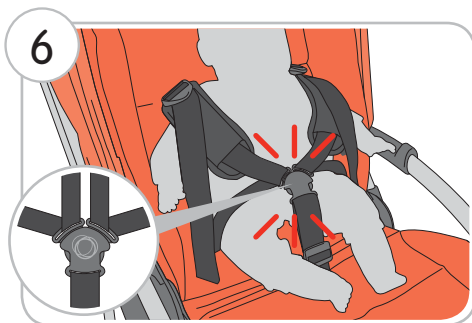

WARNING

Avoid being caught off-guard by your child making unexpected movements.
Always use the crotch strap in combination with the waist belt.
Always use the harness to avoid serious injury from falling or sliding out.
An audible click must be heard when the harness is clicked into the buckle.
The harness must be adjusted to fit your child and must be properly secured.

1

adjusting the sun canopy



2

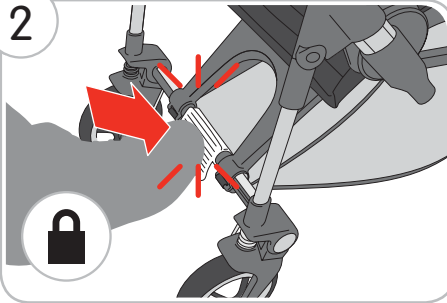

3

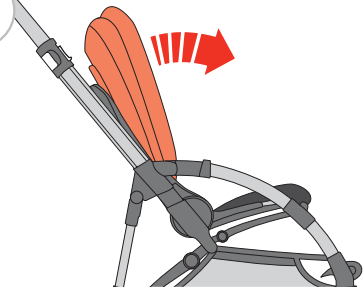

4

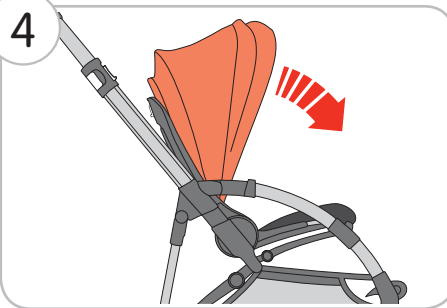

5

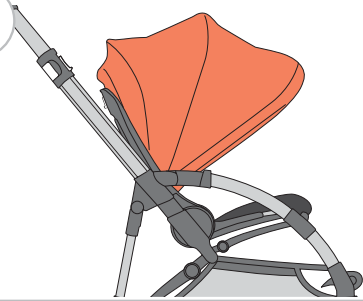

WARNING

Children have very sensitive skin. Never put a child in the Bugaboo Bee in direct sunlight without fitting the sun canopy or taking other measures.

NOTE The sun canopy will fit the Bugaboo Bee for a child with a maximum bottom-to-head length of 59 cm/23.5 inches when the backrest is fully extended.

1

adjusting the handlebar



2

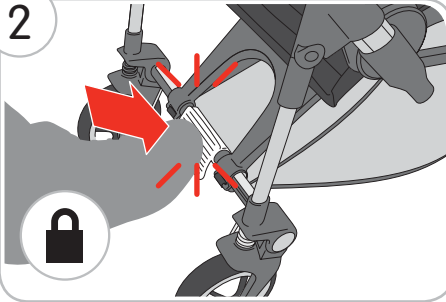

3

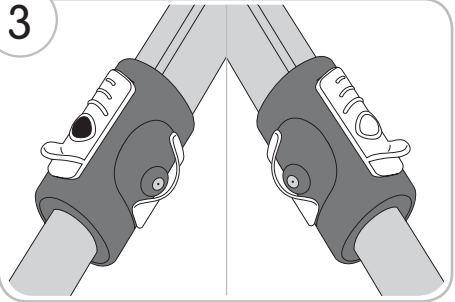

4

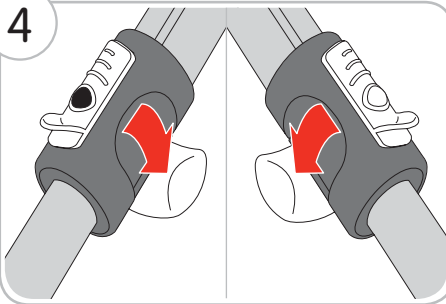

5



6

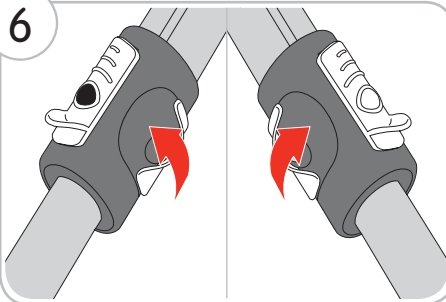

1

using the wrist strap



2

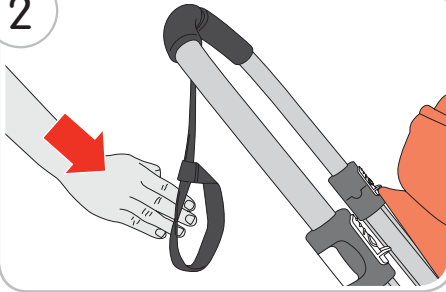

3

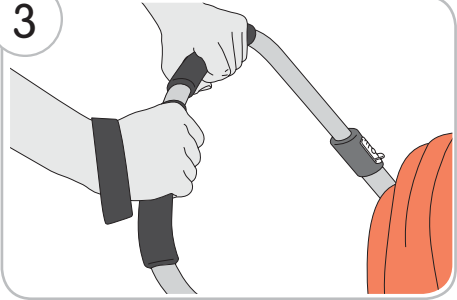

WARNING

The wrist strap must be worn at all times.

1

locking the swivel wheels



2

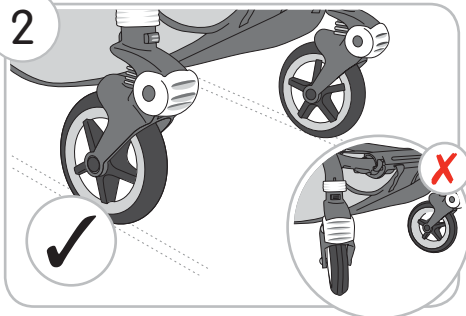

3

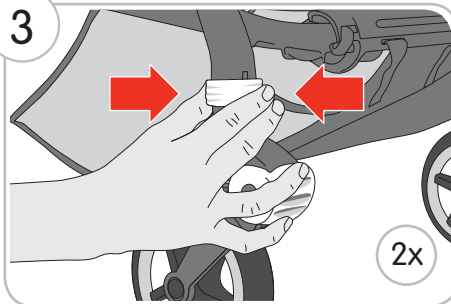

4

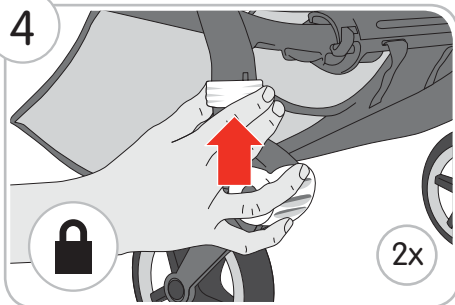

NOTE locking the wheels will give you a stable ride on uneven surfaces.

1

unlocking the swivel wheels



2

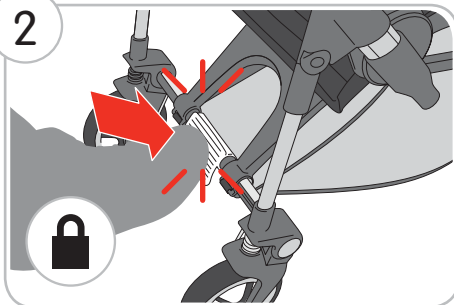

3

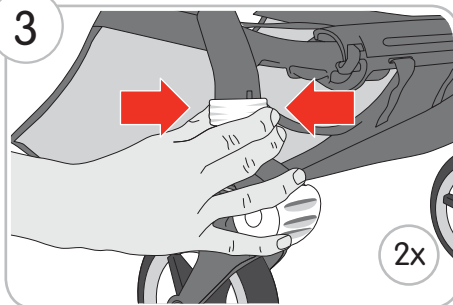

4

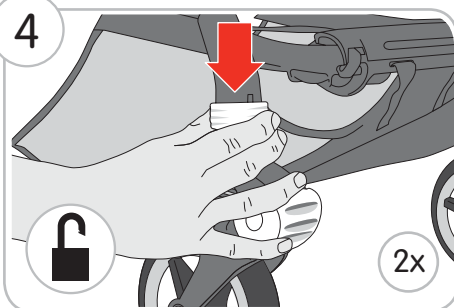

1

turning the seat unit – facing you



2

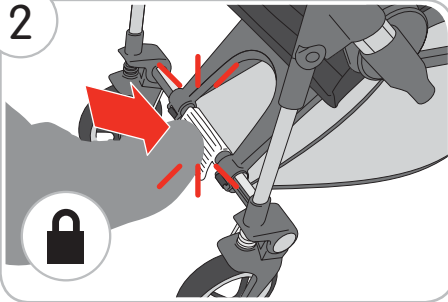

3

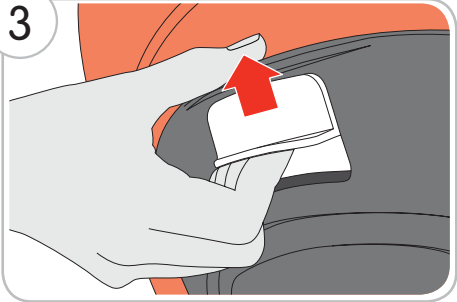

4



5

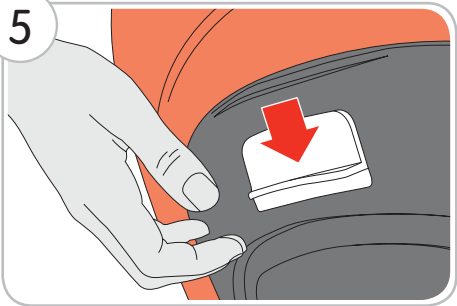

6



7



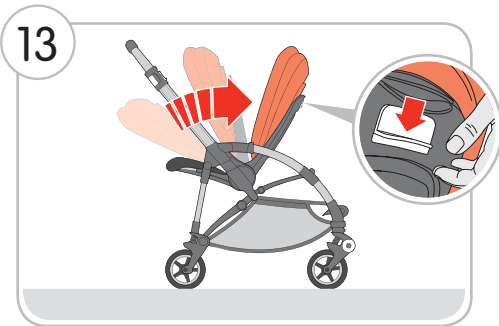
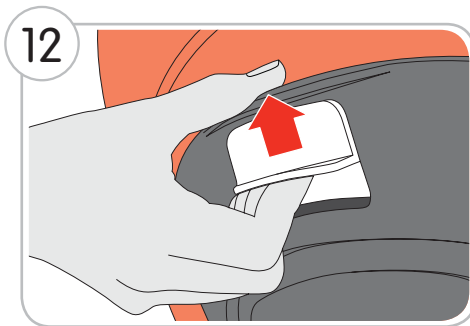
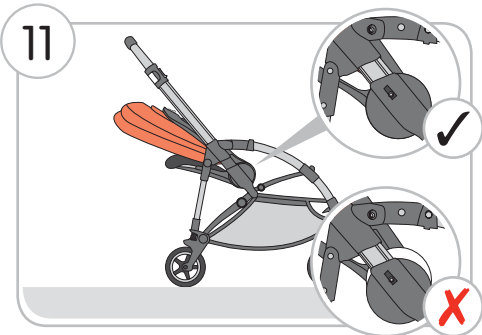
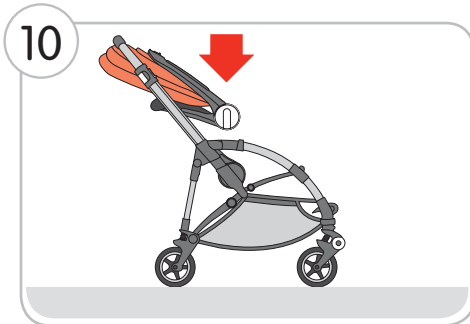
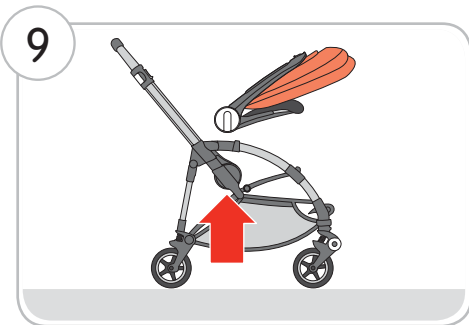
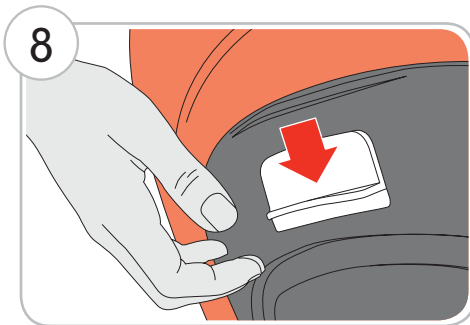

WARNING

The seat is not intended to be used as a carry seat or for any purpose other than in conjunction with the Bugaboo Bee chassis.

Do not remove the seat unit from the chassis while your child is in the seat unit.

1

turning the seat unit – facing the world



2

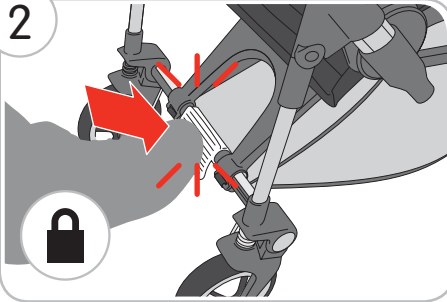

3

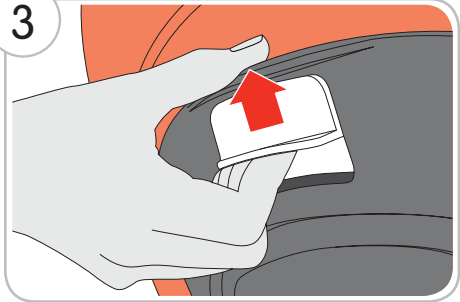

4



5

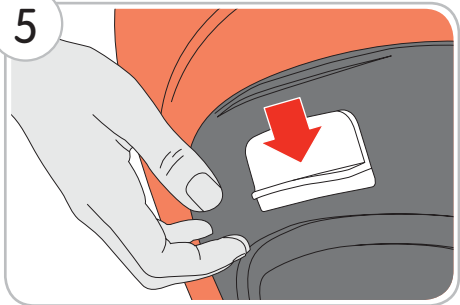

6

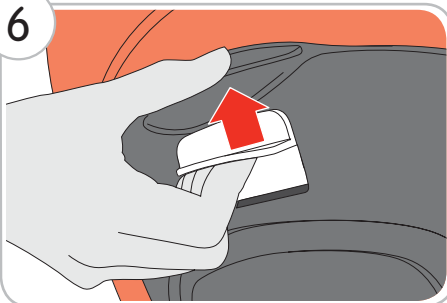

7



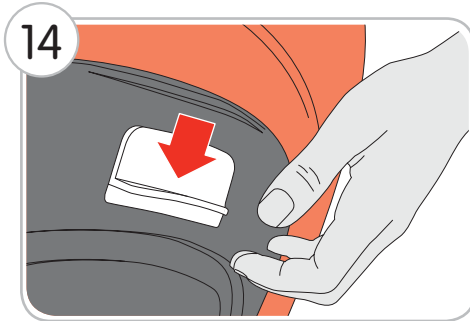
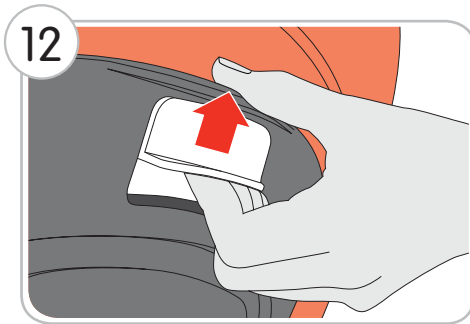
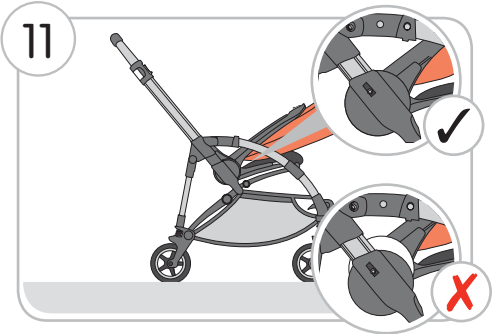
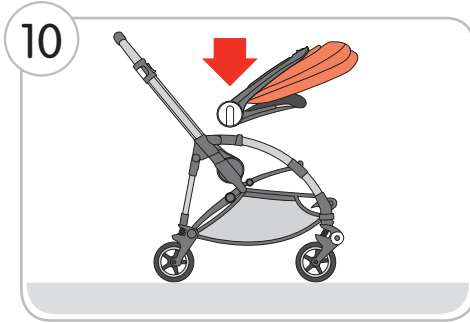
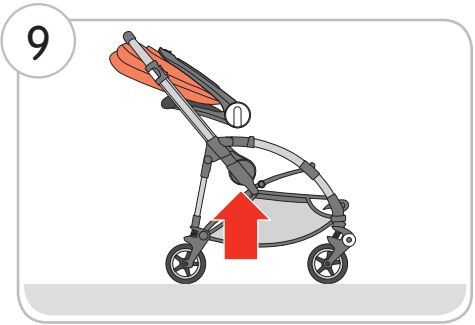
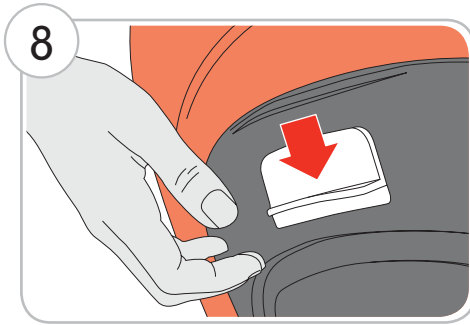



WARNING

The seat is not intended to be used as a carry seat or for any purpose other than in conjunction with the Bugaboo Bee chassis.

Do not remove the seat unit from the chassis while your child is in the seat unit.

1

attaching the rain cover

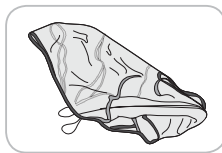

+

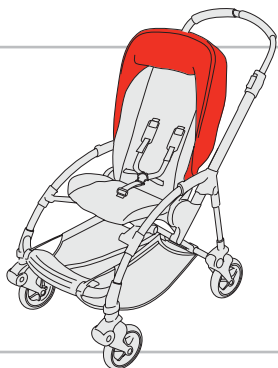

2

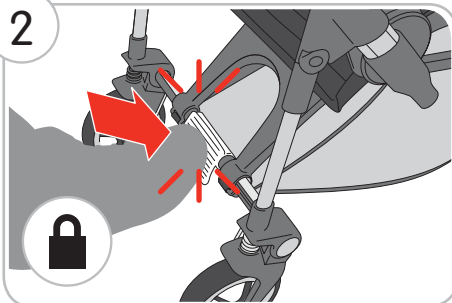

3



4

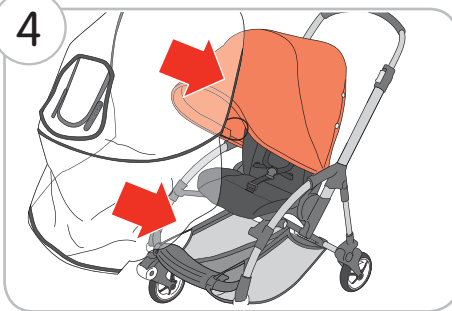

5

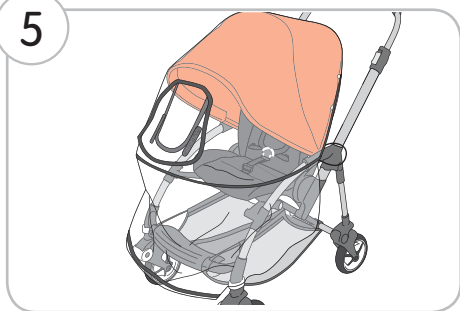

6

2x

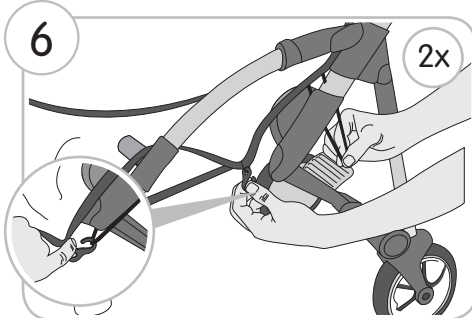

7

2x

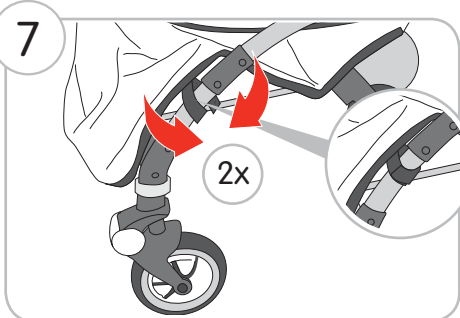

8

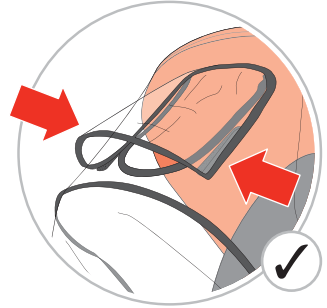

NOTE The rain cover will fit the Bugaboo Bee for a child with a maximum bottom-to-head length of 59 cm/23.5 inches when the backrest is fully extended.



WARNING

To prevent your child from overheating, do not leave them under the rain cover if it is not raining. Ensure that there is proper ventilation by using the air vent.

1

removing the underseat basket



2

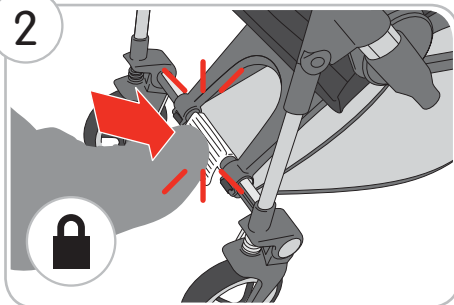

3

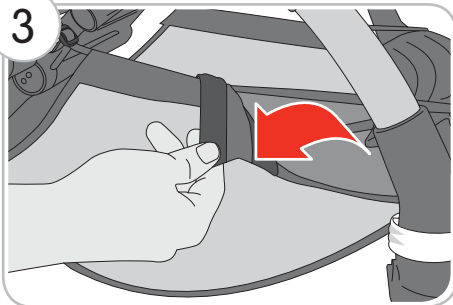

4

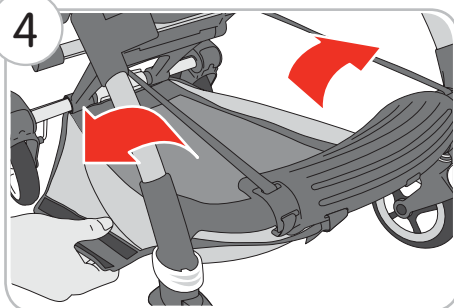

5

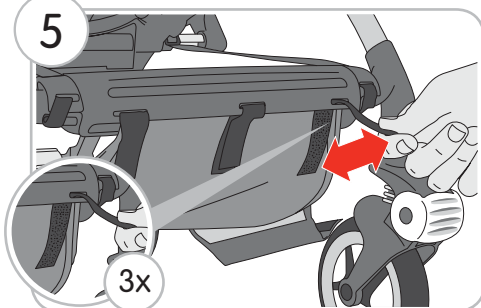

6

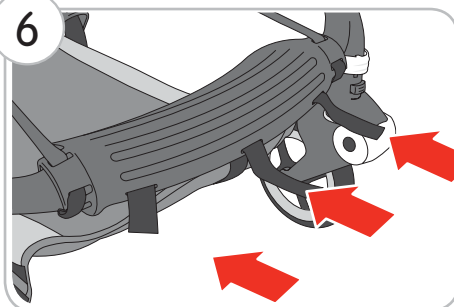

7

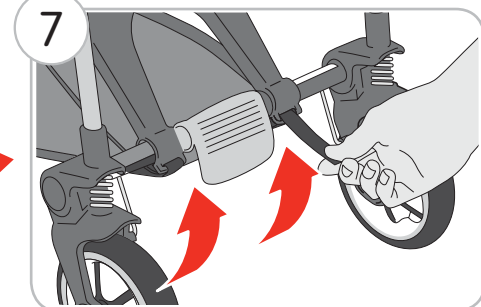

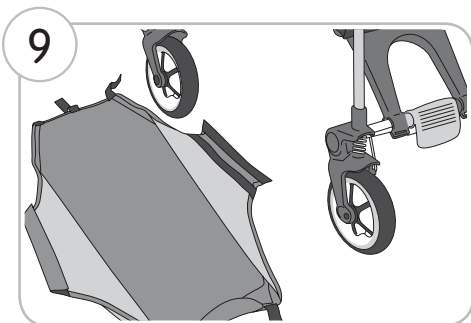
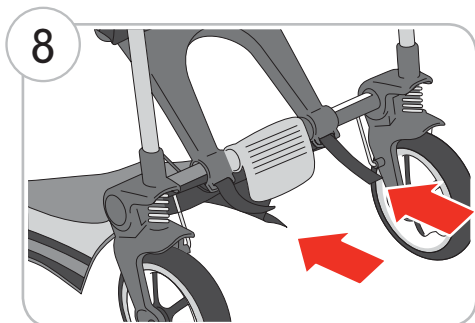

WARNING

The underseat basket is made to carry a maximum weight of 4 kg (8.8 lbs). Exceeding this amount may create an unstable and hazardous condition.

1

removing the sun canopy



2

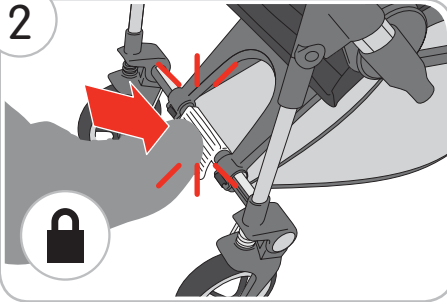

3

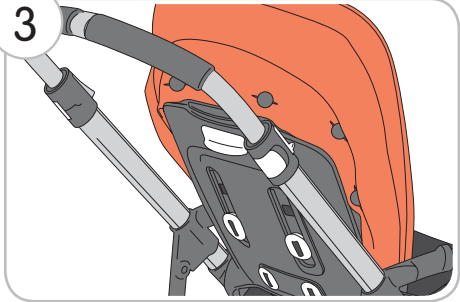

4

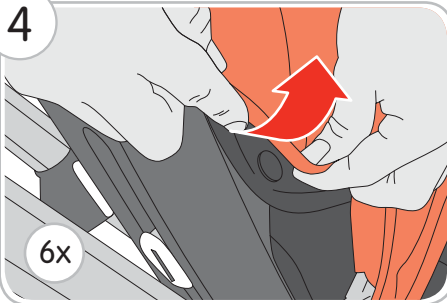

6x

5

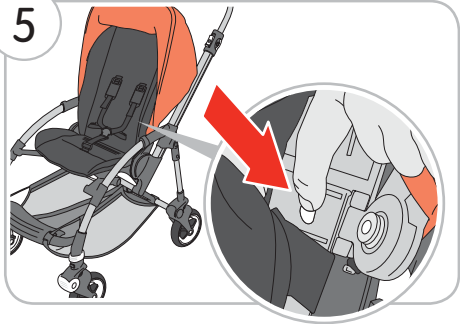

6

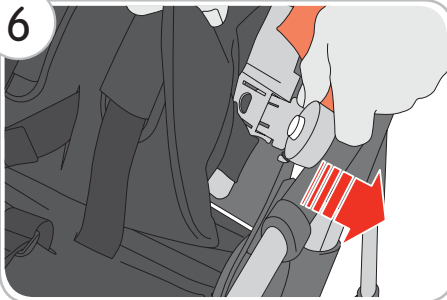

7

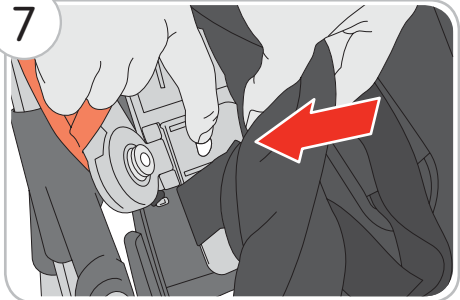

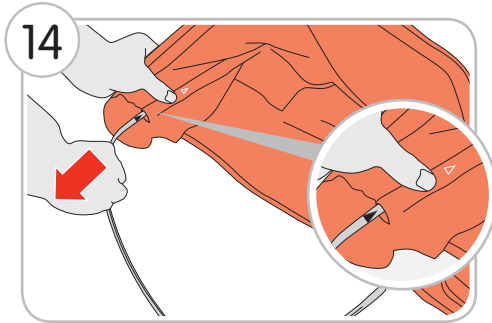
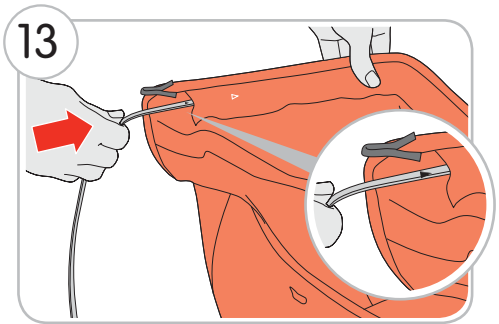
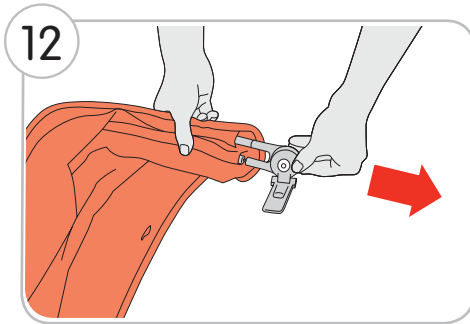
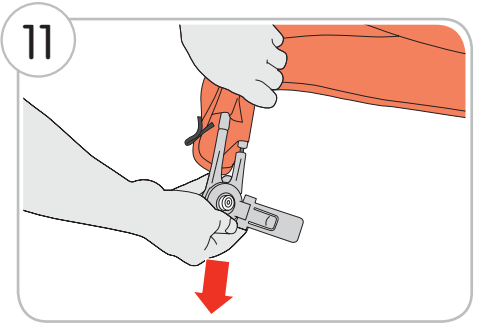
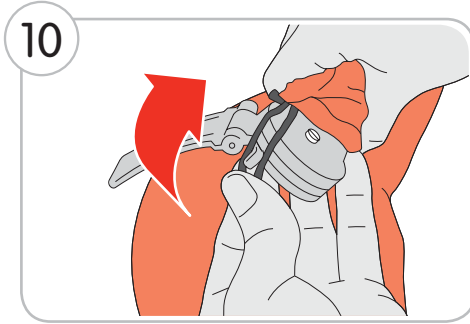
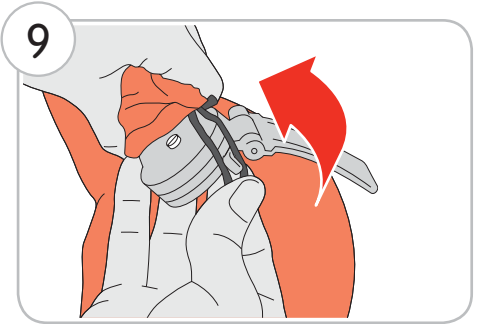
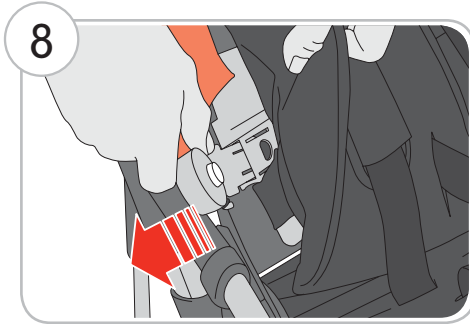



WARNING

Do not remove the sun canopy from the clamps without first removing the clamps from the Bugaboo Bee. Leaving the sun canopy clamps attached without the sun canopy will leave potentially harmful parts exposed that may harm you or your child.

1

removing the seat fabric



2

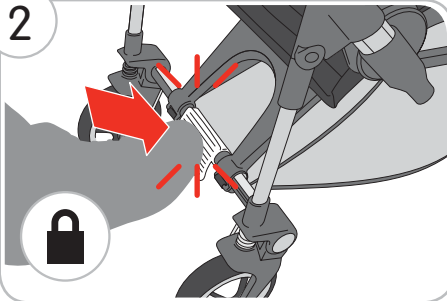

3

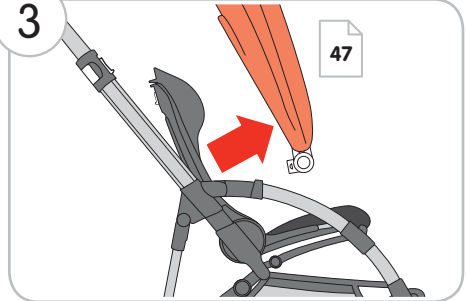

4

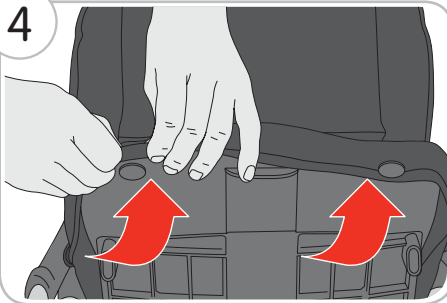

5

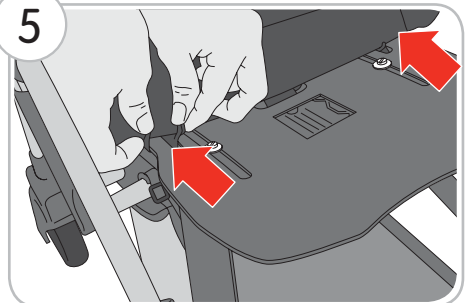

6

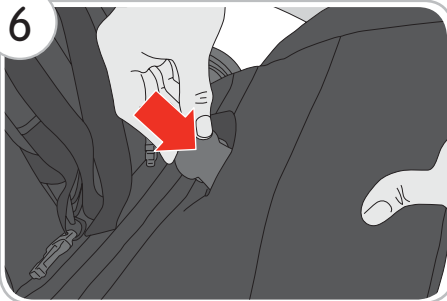

7

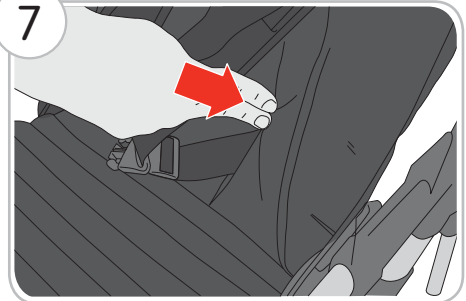

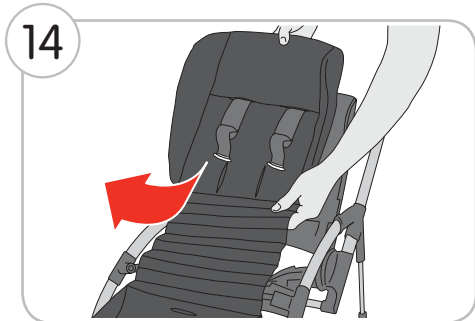
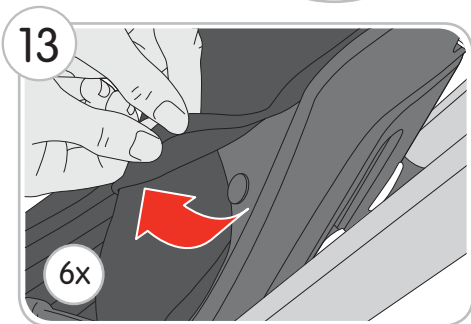
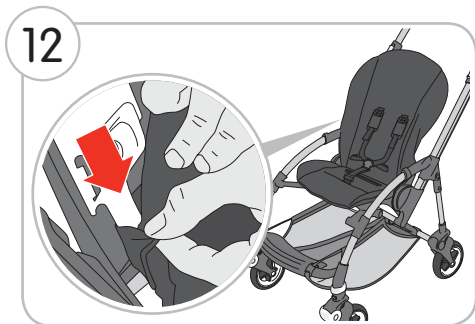
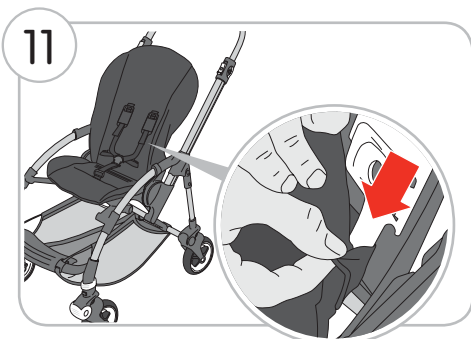
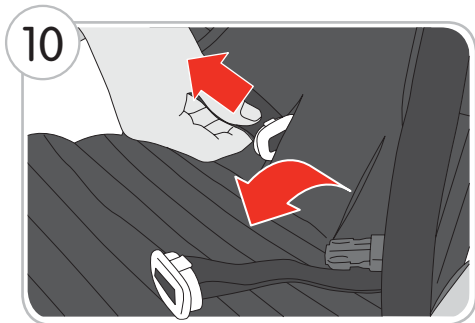
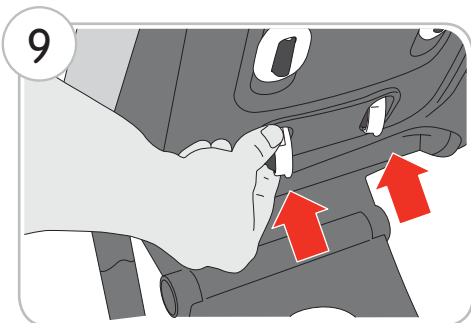
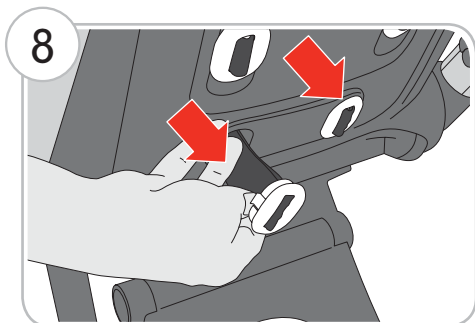

1

reattaching the seat cover



2

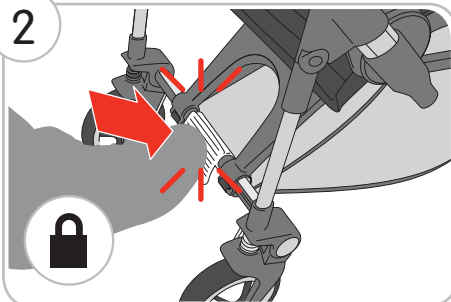

3

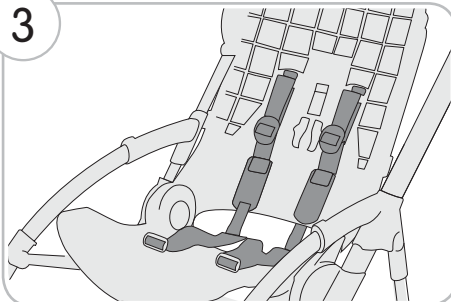

4

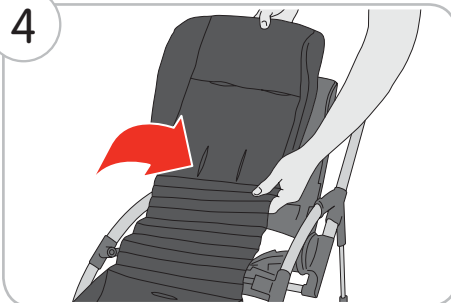

5

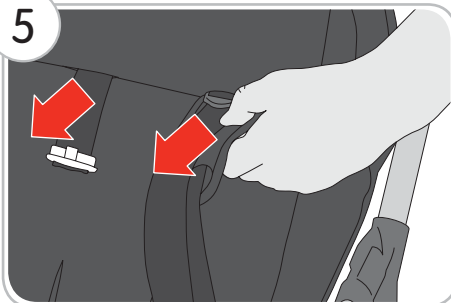

6

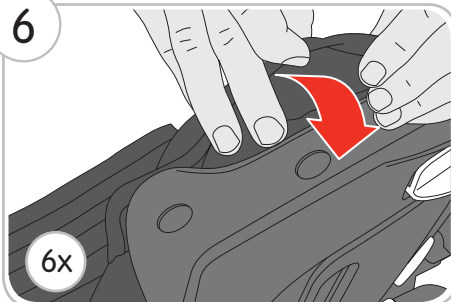

7

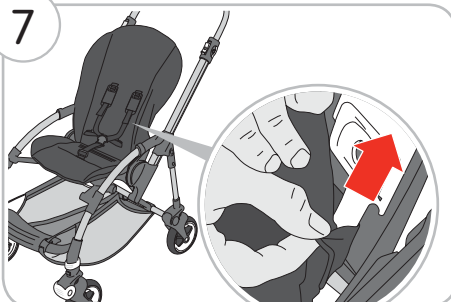

en

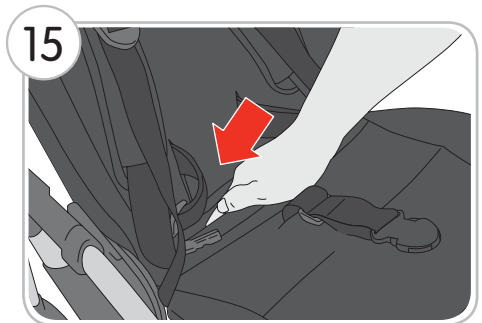
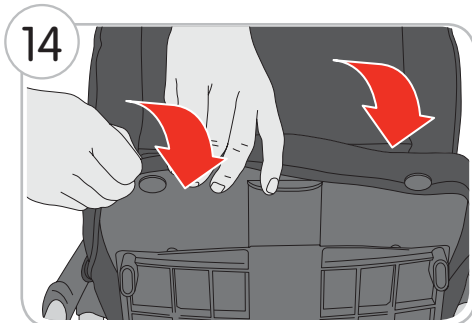
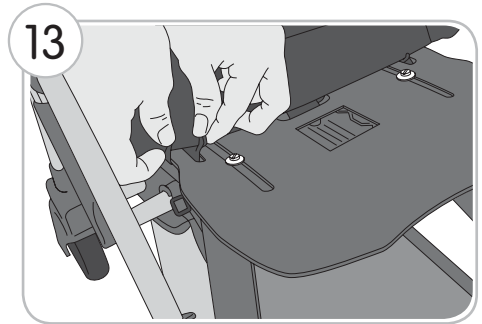
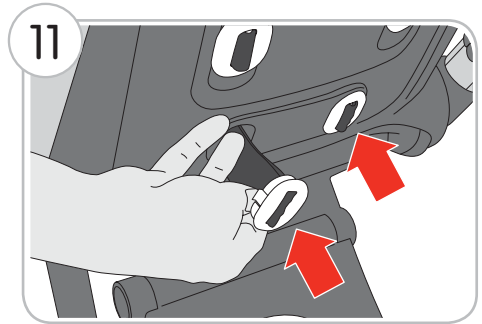
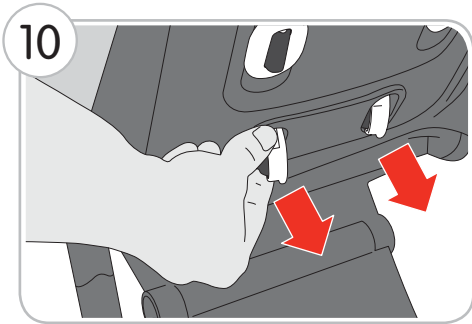
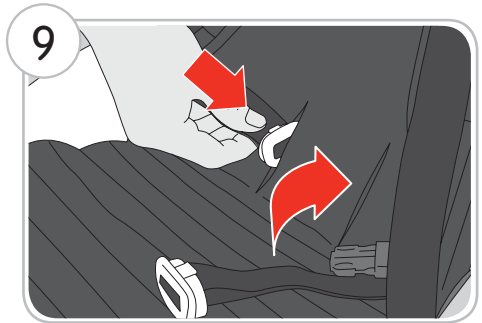
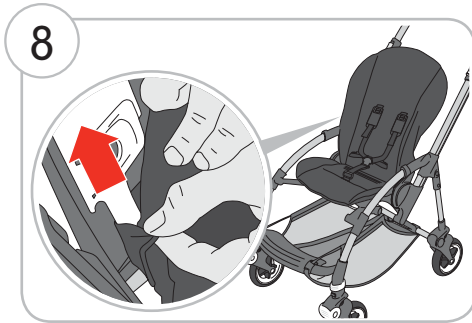

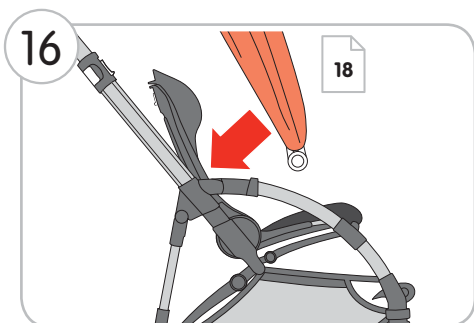

WARNING

Ensure that the seat cover is securely fastened at all points before use.

enjoy

You're loving your new Bugaboo Bee.

Please visit bugaboo.com to meet other Bugaboo Bee users, see the great accessories available and learn more about the world of Bugaboo.

See you soon



bugaboo europe & asia

bugaboo international bv
po box 1299
1000 bg amsterdam
the netherlands

bugaboo americas

bugaboo north america inc
po box 2051
manhattan beach, ca 90267-2051
usa

www.bugaboo.com