

Utility Pole for Answer® Panel and Answer® Fence

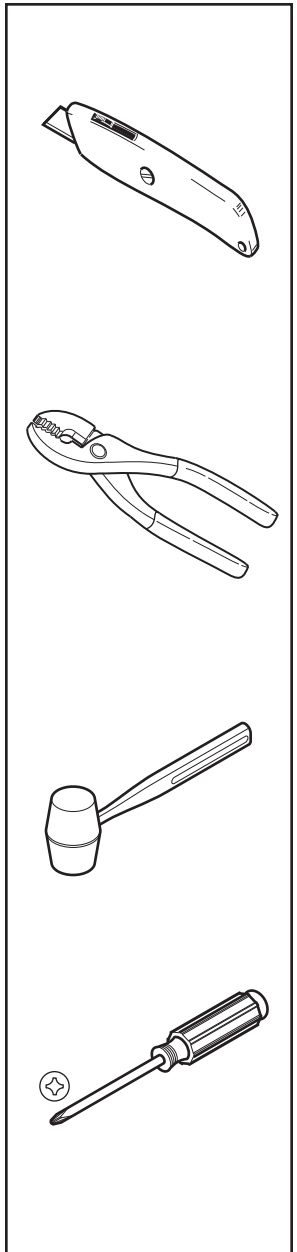

If you have a problem, question, or request, call your local dealer, or Steelcase Line 1 at **888.STEELCASE** (888.783.3522) for immediate action by people who want to help you.

(Outside the U.S.A., Canada, Mexico, Puerto Rico, and the U.S. Virgin Islands, call: 1.616.247.2500) Or visit our website: www.steelcase.com

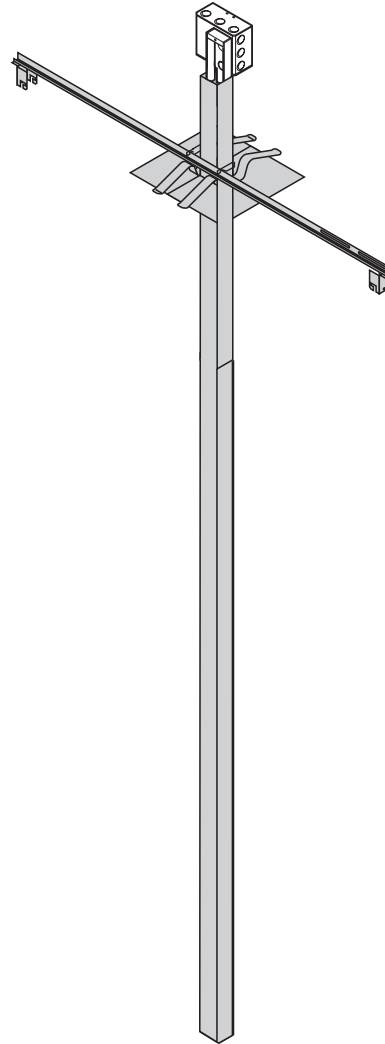

© 2014 Steelcase Inc.
Grand Rapids, MI 49501
U.S.A.

Printed in U.S.A.

WARNING :

ALL ELECTRICAL INSTALLATIONS SHOULD BE PERFORMED BY A QUALIFIED PERSON IN ACCORDANCE WITH CODES AND REGULATIONS APPLICABLE AT THE INSTALLATION SITE. CIRCUITS SHOULD BE CHECKED FOR PROPER VOLTAGES ALL SOURCES OF POWER SUPPLY MUST BE DISCONNECTED PRIOR TO ANY SERVICING OR INSTALLATION

<u>Optional Wiring Schematics:</u>	<u>System</u>	<u>Block Color</u>
<ul style="list-style-type: none"> • 2-General Circuits with Shared Neutral & System Ground and 2-Designated circuits with Shared Neutral and Isolated Ground 	(2+2)	Brown
<ul style="list-style-type: none"> • 3-Separate Circuits - 2 with own Neutral and Isolated Ground, 1 with own Neutral and System Ground 	(3SN)	Rust
<ul style="list-style-type: none"> • 4-Circuit, 3 with Shared Neutral and System Ground and 1- Isolated Circuit and Ground 	(3+1)	Black

	<p>WARNING :</p> <p>ALL ELECTRICAL INSTALLATIONS SHOULD BE PERFORMED BY A QUALIFIED PERSON IN ACCORDANCE WITH CODES AND REGULATIONS APPLICABLE AT THE INSTALLATION SITE. CIRCUITS SHOULD BE CHECKED FOR PROPER VOLTAGES</p> <p>ALL SOURCES OF POWER SUPPLY MUST BE DISCONNECTED PRIOR TO ANY SERVICING OR INSTALLATION</p>	
---	---	---

<p><u>Notes on Chicago Installations:</u></p> <ul style="list-style-type: none"> • Must be field wired under authority of a permit by a contractor licensed in the city of Chicago. • Harnesses and quick connect connectors not allowed in the city of Chicago. • UL listed under File 2R75.
--

ELECTRICAL DATA:

120V 60HZ 20Amp USA
 15Amp CANADA
 208Y/120 VC3-Phase Service
 240/120 VC1-Phase Service

Wiring schematics must be followed to prevent overloading of the neutrals.

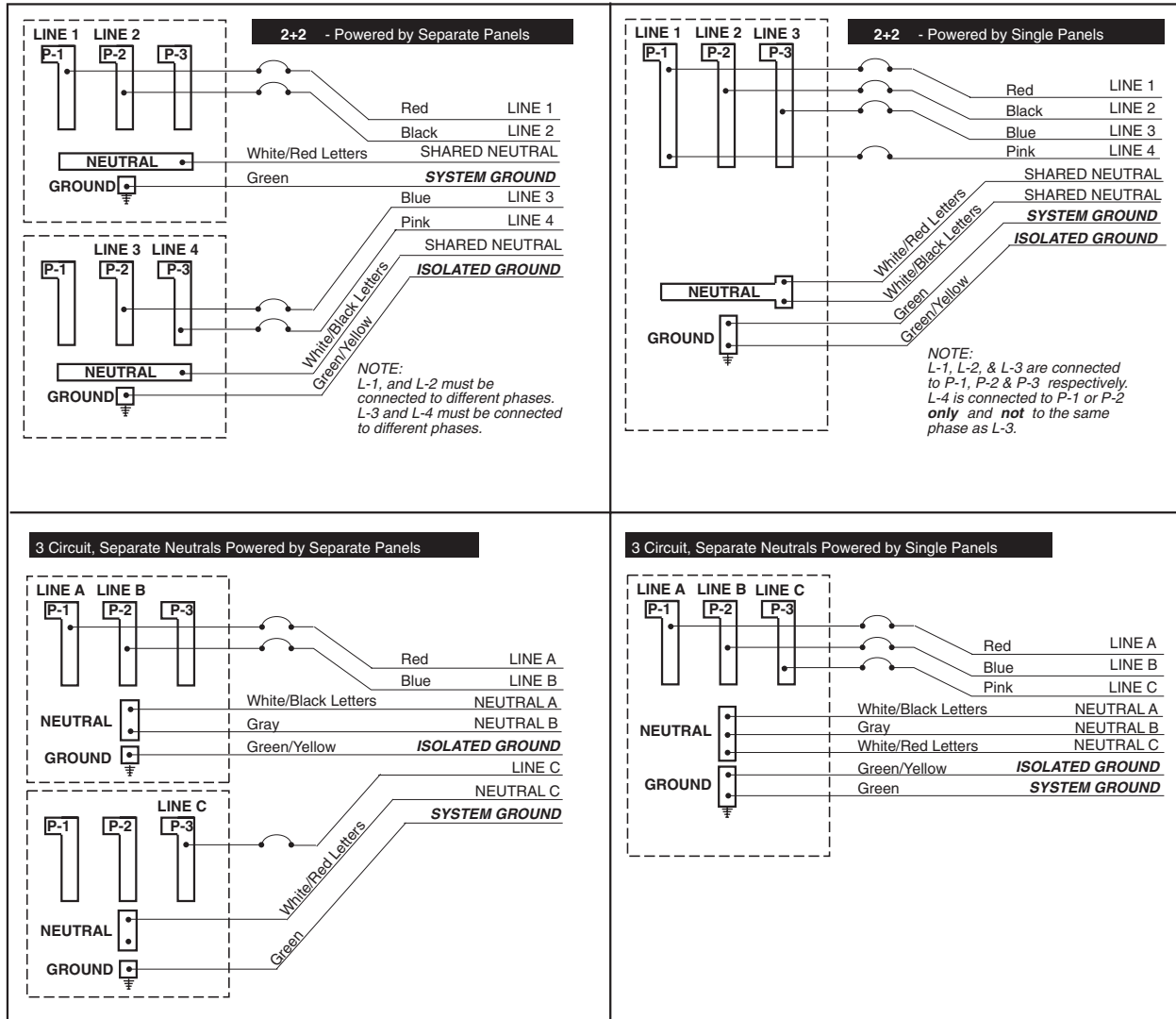

WARNING:
 Risk of Fire or Electric Shock: This office furnishing system may be connected to more than one source of supply. All sources must be disconnected prior to any servicing. No single circuit may be powered by more than one source. All sources of power supply must be disconnected prior to any servicing or installation.

ELECTRICAL DATA:

120 V 60 HZ 20 Amp USA
 15 Amp CANADA
 208Y/120 VAC 3-Phase Service
 240/120 VAC 1-Phase Service

Wiring schematics must be followed to prevent overloading of the neutrals.

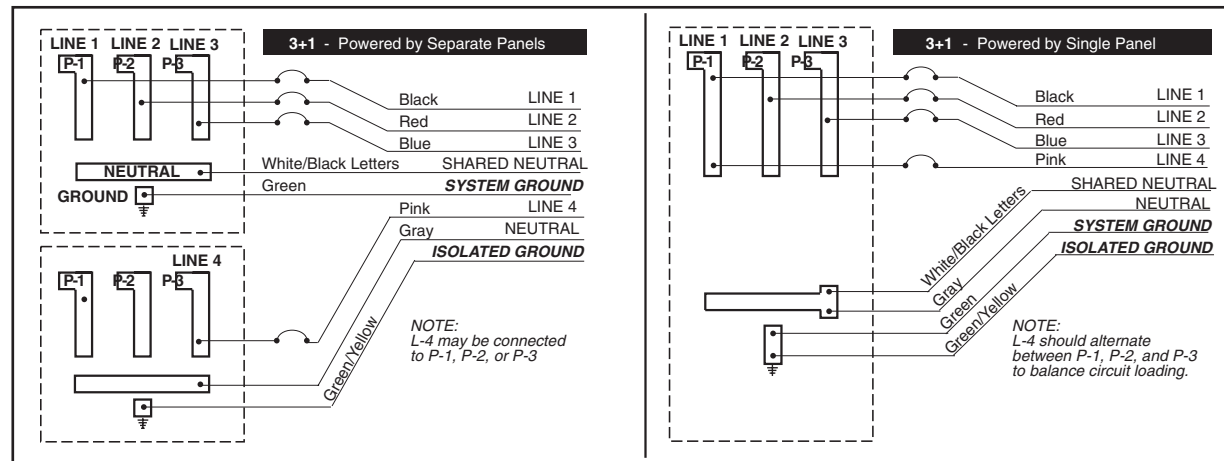

WARNING:

Risk of Fire or Electric Shock: This office furnishing system may be connected to more than one source of supply. All sources must be disconnected prior to any servicing. No single circuit may be powered by more than one source. All sources of power supply must be disconnected prior to any servicing or installation

Step 1:
Prepare ceiling for installation.



These diagrams are to clarify the location of a Utility Pole in each panel configuration.

Furniture Configuration: EOR

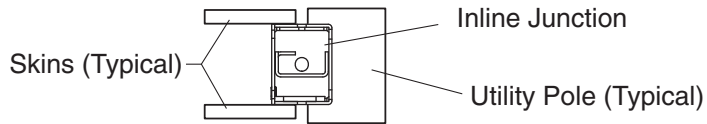

Style Numbers:

TS7XXERUP (Thin and Oval Trim)

TS7XXSERUP (Thin and Square Trim)

Furniture Configuration: L and Inline

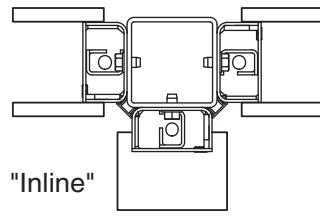
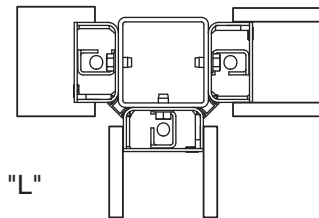

TS7XXLUP (Oval Trim)

TS7XXSLUP (Square Trim)

Furniture Configuration: T

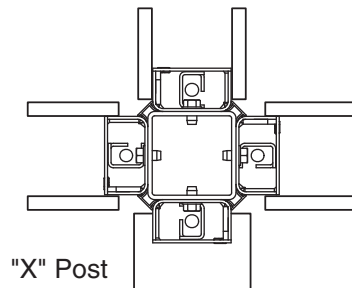

TS7XXTUP (Oval Trim)

TS7SXXSTUP (Square Trim)

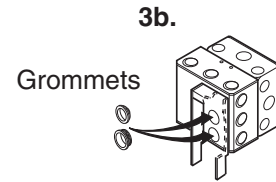
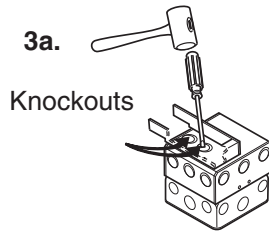

Step 2:
Mount universal lower channel to vertical junction.

Step 3:
a. Remove required knockouts from "J" box.

b. Install required grommets into "J" box, per hole Diameter.

c. Mount junction box to upper channel. Slide upper channel assembly over lower channel and seat in notch at top of junction. Secure upper channel and lower channel with blunt screws.

Step 4:
Lay in power and communication. Press outer covers over channel assembly as shown.

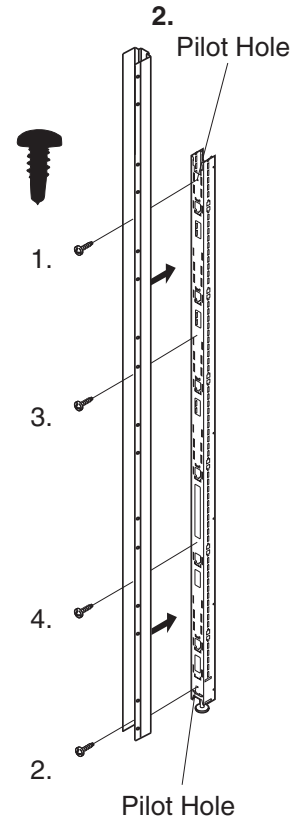

NOTE:
Pilot holes provided for locations 1 & 2 only.

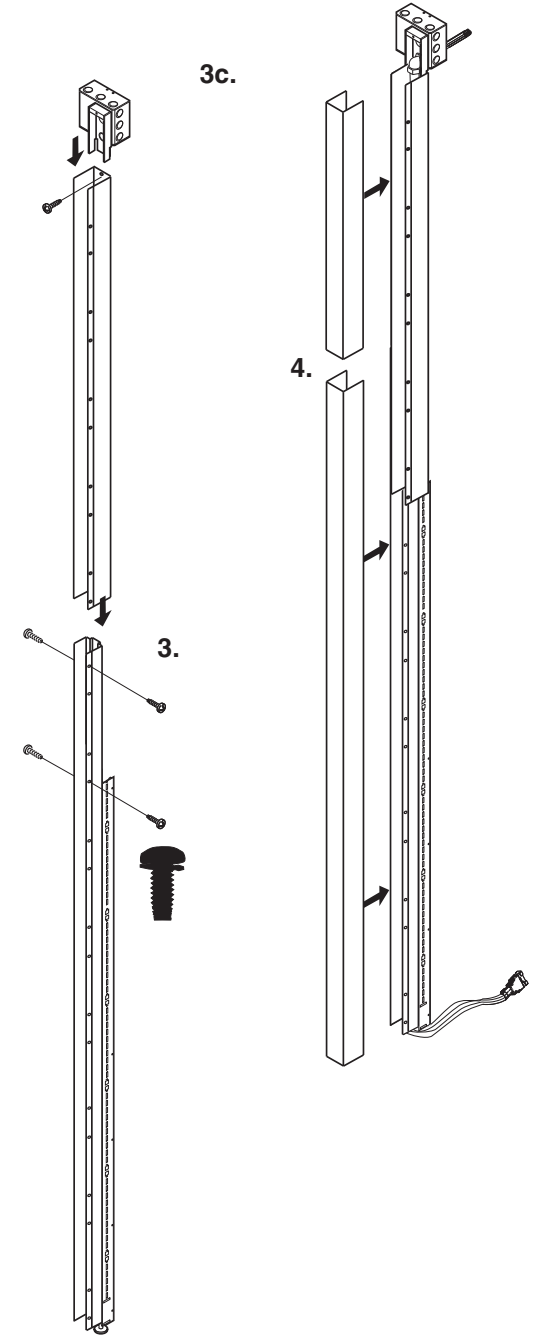

Steelcase

Step 5:
Locate pole and cut out relief in ceiling.

Step 6:
Install ceiling tile.

Step 7:
Install ceiling bracketry.

Step 8:
Install decorative ceiling covers.

