

**ROUPEIRO 4 PORTAS / WARDROBE 4 DOORS / ARMARIO 4 PUERTAS**  
**PH-1714**

**Montagem**

Recomenda-se a leitura prévia das instruções de montagem e profissionais especializados para montar.

**Assistência**

Caso ocorra problema com algum dos componentes, sublinhe-o, identifique o problema e retorne esta relação, via fax ou outro meio de comunicação disponível para o representante.

-----  
Assinatura do cliente

**Assembly**

Before the assembling is recommended to read carefully the assembly instruction by professional assemblers.

**Assistance**

If happen problems with any component, underline the same, identify the problem and send back this relation immediately, by fax or other way.

-----  
Client signature

**Montaje**

Se recomienda la lectura previa de las instrucciones de montaje y profesionales especializados para montarlos.

**Assistencia**

Caso sucedan problemas con alguno de los componentes, subraye el componente, identifique el problema, y retorne esta copia via fax u otro medio de comunicación posible.

-----  
Assinatura del cliente

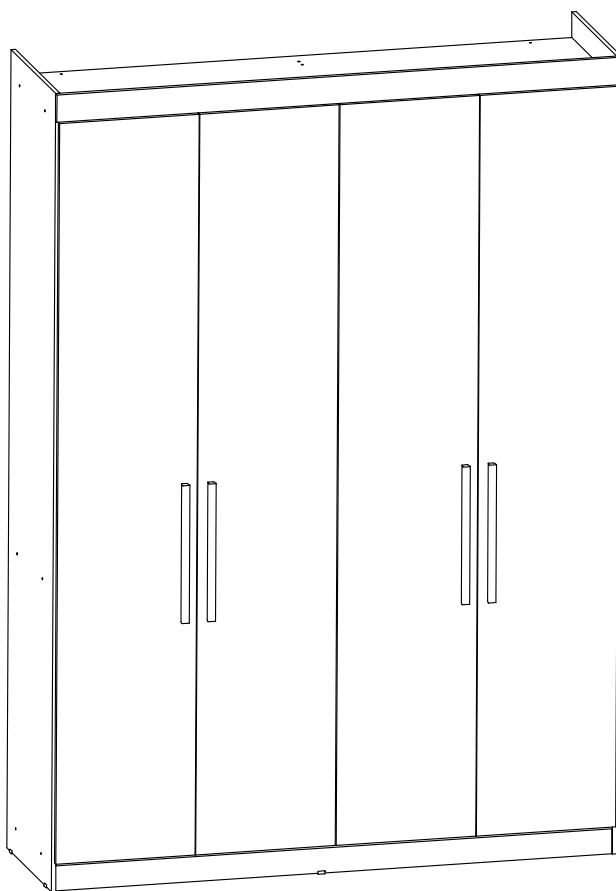

**Atenção / Attention / Atención**

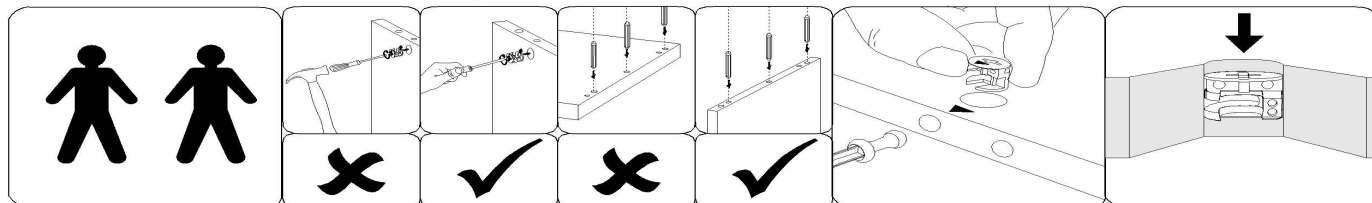

A Herval se reserva o direito de efetuar alterações nos produtos de suas linhas sem aviso prévio, quando entender necessário.

Herval reserves the right to effect modifications in the products, without previous advice, when understand necessary.

Herval se reserva el derecho de hacer las modificaciones que juzgue necesarias en sus productos, sin aviso previo, cuando lo crea necesario.

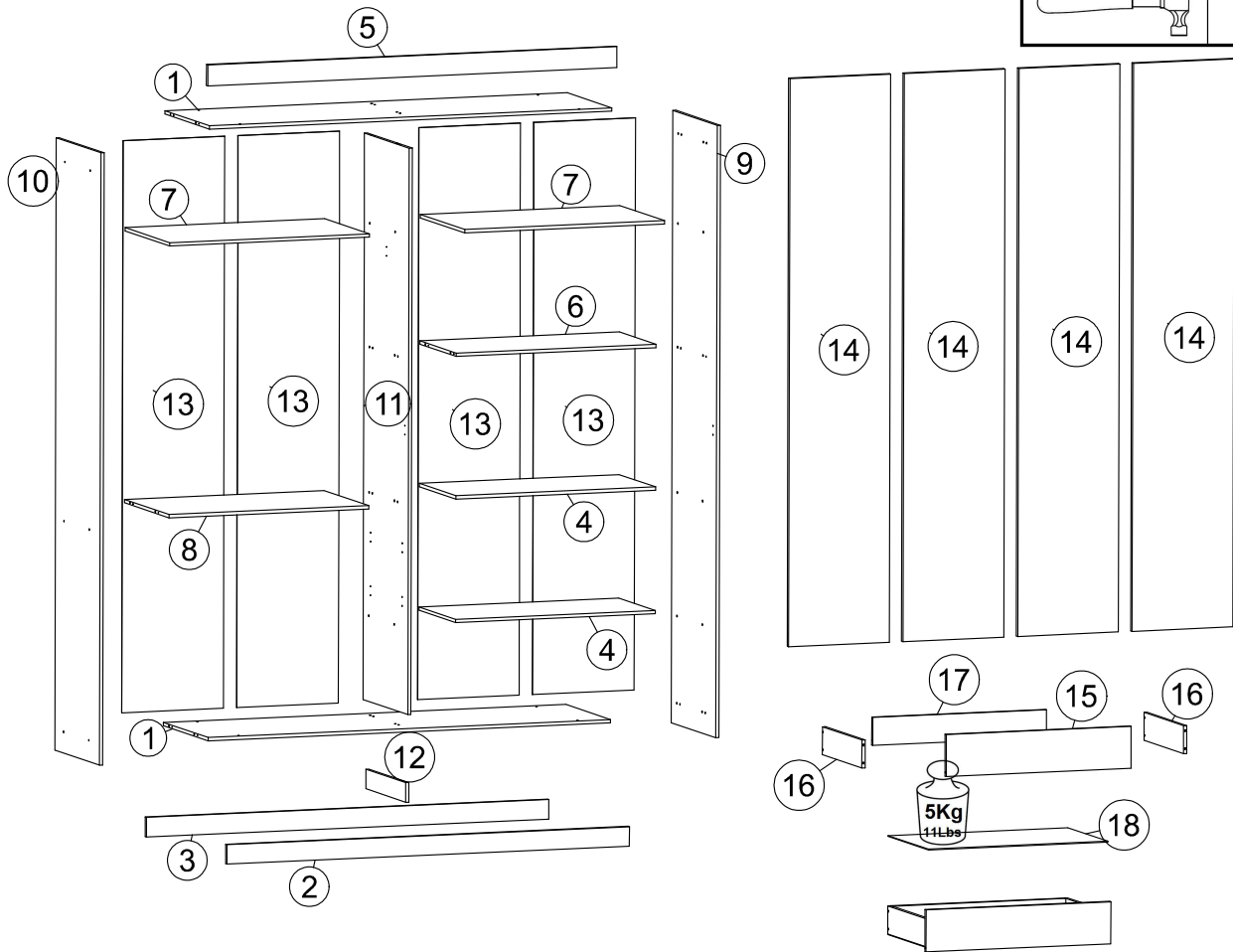
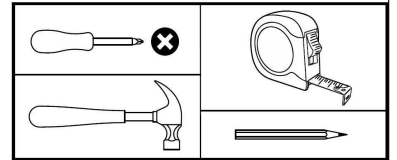

## LISTA DE PEÇAS / PARTS LIST / LISTA DE PIEZAS Volume 1

ÍNDICE / INDEX	CÓD. / CODE	PEÇA / PART / PIEZA	MED/MEASURE	QTDE / QUANT / CANT
1	157788L	BASE/TAMPO	1526.0x452.0x12.0	2
2	157789E	RODAPÉ FRENTE	1526.0x70.0x12.0	1
3	157790E	RODAPÉ ATRÁS	1526.0x70.0x12.0	1
4	157791L	PRATELEIRA MÓVEL	757.0x369.0x12.0	2
5	157799E	VISTA SUP	1551.0x75.0x15.0	1
6	157800L	PRATELEIRA FIXA	757.0x369.0x12.0	1
7	157792L	MALEIRO	757.0x452.0x12.0	2
8	157795L	TAMPO GAVETEIRO	757.0x452.0x12.0	1
15	157626L	FRENTE GAVETA	701.0x150.0x12.0	2
16	157629L	LATERAL DE GAVETA	400.0x100.0x12.0	4
17	157630L	TRASEIRO DE GAVETA	658.0x100.0x12.0	2
20	068307 - 1600921	CORREDICA NORMAL 400MM	xx	2
21	1601759	TUBO OBLONGO 746MM	746.0x30.0x15.8	1
22	1606889	PUX BRA-M-0424 CARV 2F 378MM KIT 6PC	378.0x20.0x20.0	4
-	K072455	KIT DOBRADIÇAS	-	3
-	K072493	KIT ACESSÓRIOS	xx	1

## Volume 2

ÍNDICE / INDEX	CÓD. / CODE	PEÇA / PART / PIEZA	MED/MEASURE	QTDE / QUANT / CANT
9	157796L	LATERAL DIREITA	2190.0x452.0x12.0	1
10	157797L	LATERAL ESQUERDA	2190.0x452.0x12.0	1
11	157798L	DIVISAO	2026.0x452.0x12.0	1
12	157794E	TRAVESSA RODAPE	404.0x70.0x12.0	1
13	157793L	FUNDO	2046.0x385.0x3.0	4
18	157631L	FUNDO GAVETA	407.0x681.0x3.0	2
19	1608138	PERFIL I 2046X20X3,8MM CINZA CIMENTO 053	2046.0x17.0x6.0	2

## Volume 3

ÍNDICE / INDEX	CÓD. / CODE	PEÇA / PART / PIEZA	MED/MEASURE	QTDE / QUANT / CANT
14	157801L	PORTA	2032.0x382.0x15.0	4

## LISTA DE ACESSÓRIOS / FITTINGS LIST / LISTA DE ACESSORIOS

CÓD./ CODE: K072493					
REF.	PEÇA	PART	PIEZA	QTDE	CÓDIGO
A	PREGO 10 X 10 C/CABEÇA - Ø1,5 x 23mm	NAIL 10 x 10 - Ø1,5 x 23mm	CLAVO 10 x 10 - Ø1,5 x 23mm	91	1605365
B	FIXADOR PARA COSTAS ZINCO BR	Back Panel Bracket	Soporte Panel Trasero	13	1601469
C	CAVILHA DE MADEIRA 6X40	Dowel Ø6 x 40 mm	Tarugo Ø6 x 40 mm	28	1604742
D	SAPATA QUADRADA 12x12 (CINZA)	SQUARE SHOE 12 x 12	ZAPATO CUADRADO 12 x 12	6	1606846
E	SUPORTE TUBO OBLONGO PLÁSTICO	SUPPORT PIPE OBLONGO PLASTIC	APOYO TUBERÍA OBLONGO PLÁSTICO	2	1603790
F	CANTONEIRA 18x18 (ZB)	ANGLE 18 x 18 (ZB)	ANGULO 18 x 18 (ZB)	11	1604301
G	SUPORTE PRATELEIRA 6x6 (CINZA)	Shelf Support 6x6	Soporte Repisa 6x6	16	1604347
G1	GIZ CERA NOG-CEDRO-FENDI-FREIJÓ Ø14x8MM	WAX CHALKS Ø14x8MM	TIZAS DE CERA Ø14x8MM	1	XXXXXXXX
G2	GIZ CERA BRANCO Ø14x8MM	WAX CHALKS Ø14x8MM	TIZAS DE CERA Ø14x8MM	1	XXXXXXXX
G4	GIZ CERA OFF WHITE - CINZA BP - LÍNEO Ø14x8MM	WAX CHALKS Ø14x8MM	TIZAS DE CERA Ø14x8MM	1	XXXXXXXX
H	DISTANCIADOR CILINDRICO L=44xP=20xA=25mm	CYLINDRICAL DISTANCER	DISTANCIADOR CILÍNDRICO	8	1607847
I	PARAFUSO 3 X 30 CAB. CHATA PHILIPS	Screw Ø3 x 30 mm	Tornilo Ø3 x 30 mm	4	1607848
J	PARAFUSO 3.5 X 25 CAB. CHATA PHILIPS	Screw Ø3.5 x 25 mm	Tornilo Ø3.5 x 25 mm	8	1604658
K	PARAFUSO 3 X 20 CAB. CHATA PHILIPS	Screw Ø3 x 20 mm	Tornilo Ø3 x 20 mm	8	1604857
L	PARAFUSO 4 X 12 CAB. CHATA PHILIPS REBAIXADA	Screw Ø4 x 12 mm	Tornilo Ø4 x 12 mm	50	1606847
M	PARAFUSO 4 X 40 CAB. CHATA PHILIPS	Screw Ø4 x 40 mm	Tornilo Ø4 x 40 mm	28	1604937
N	TAPA FURO ADESIVO PAPEL 15MM LÍNEO	HOLES COVER ADHESIVE 15mm	ADESIVO TAPA HUECO 15mm	8	1607532
O	SAQUINHO COLA BRANCA 10G	Glue 10g	Pegamento 10g	1	1605372

### KIT DOBRADIÇAS / HINGES KIT / KIT BISAGRAS

CÓD./ CODE: K072455					
REF.	PEÇA	PART	PIEZA	QTDE	CÓDIGO
L	PARAFUSO 4 X 12 CAB. CHATA PHILIPS REBAIXADA	Screw Ø4 x 12 mm	Tornilo Ø4 x 12 mm	48	1606847
P	CALÇO 26mm D7 (07.05.292)	CHOICE 26mm	ELECCION 26mm	12	1606860
Q	DOBRADIÇA CANECO 26mm COLO ALTO (07.05.302)	HING MUNG 26mm	TAZA CON BISAGRA 26mm	12	1606861

Opcional

### KIT ESPELHOS / MIRROR KIT / KIT ESPEJOS

CÓD./ CODE: 1606901					
REF.	PEÇA	PART	PIEZA	QTDE	CÓDIGO
R	KIT C_2PÇS VIDRO ESPELHO 1600X265X3MM	KIT MIRROR GLASS 1600x265x3MM	KIT CRISTAL ESPEJO 1600x265x3MM	2	1606901

**\*O kit acessórios possui giz para fazer retoques em possíveis falhas nas peças.**

**\*The accessory kit has chalk to make touch-ups in possible parts failures.**

**\*El kit de accesorios dispone de tiza para realizar retoques en posibles averías de piezas.**

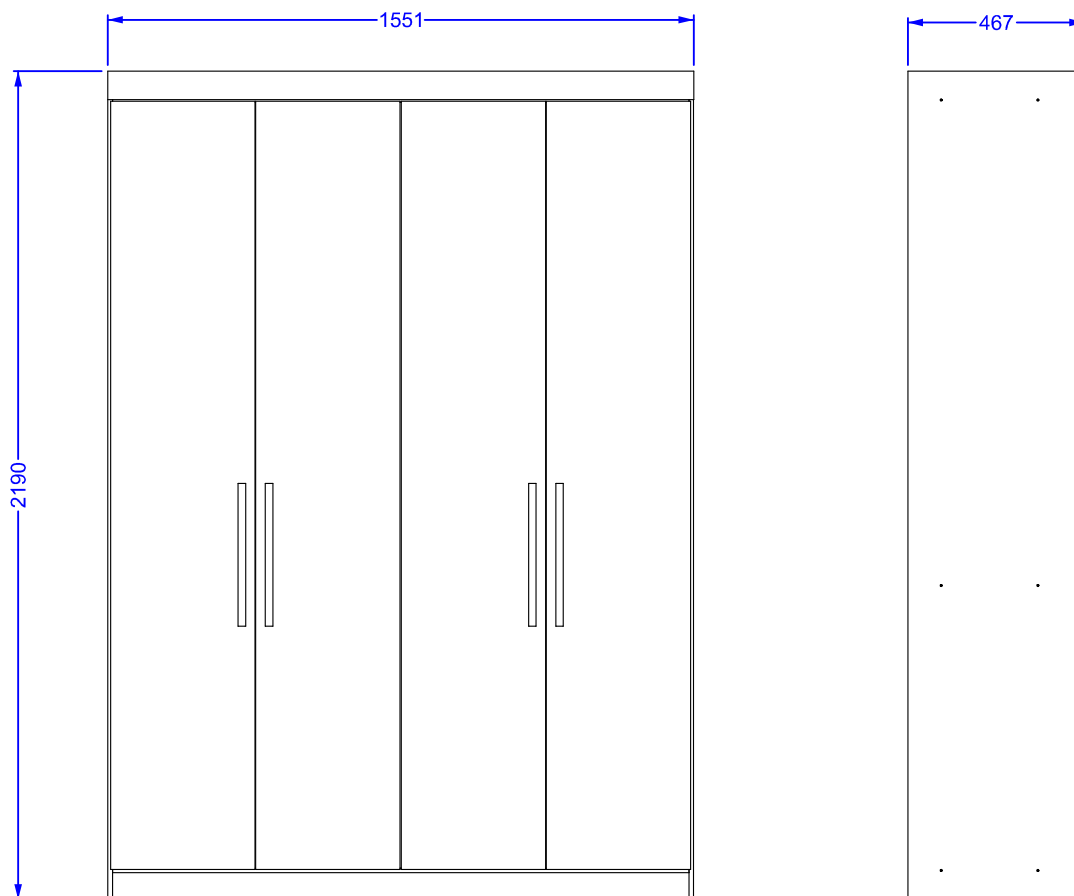







**PASSO 1  
STEP 1  
PASO 1**

PEÇAS NECESSÁRIAS  
PARTS REQUIRED  
PIEZAS NECESARIAS

INDICE	QUANT.
1	1
2	1
3	1
12	1

FERRAGEM NECESSÁRIA  
HARDWARE REQUIRED  
HERRAMIENTA NECESSARIA

INDICE	IMAGEM	QTDE
A		2
D		2
F		2
I		4
L		4
M		2

FERRAMENTAS NECESSÁRIAS  
TOOL REQUIRED  
HERRAMIENTA NECESSARIA

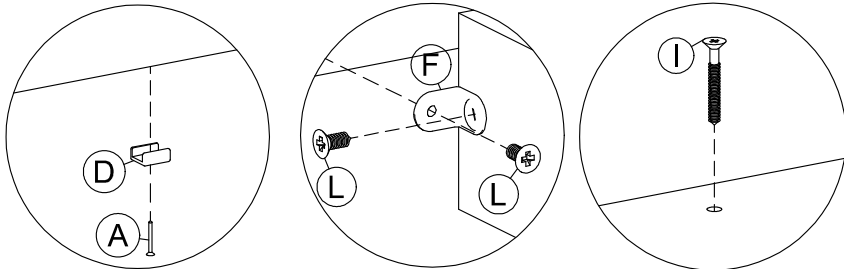
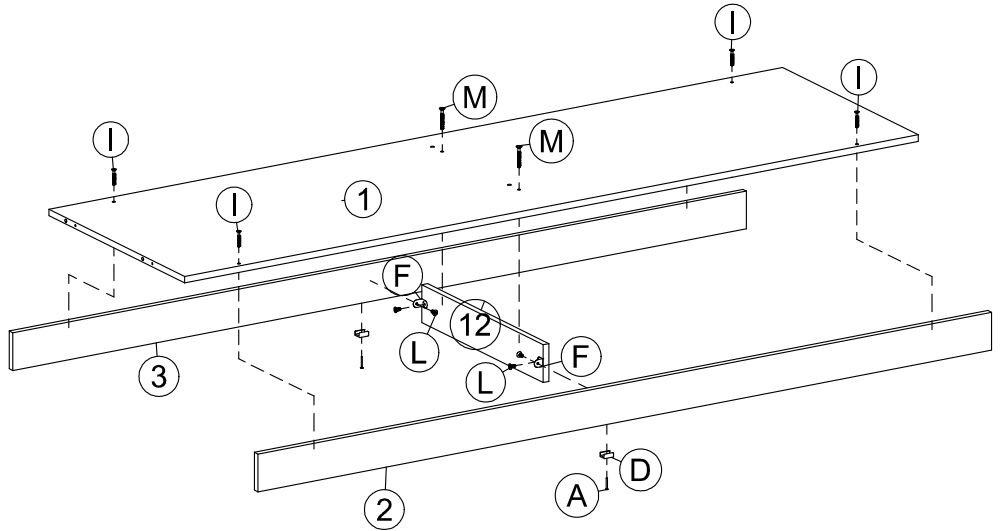
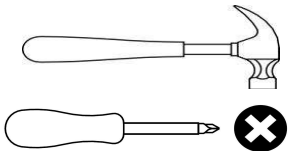





**PASSO 2  
STEP 2  
PASO 2**

PEÇAS NECESSÁRIAS  
PARTS REQUIRED  
PIEZAS NECESARIAS

INDICE	QUANT.
8	1
10	1
11	1

FERRAGEM NECESSÁRIA  
HARDWARE REQUIRED  
HERRAMIENTA NECESSARIA

INDICE	IMAGEM	QTDE
A		2
C		6
D		2
M		6

FERRAMENTAS NECESSÁRIAS  
TOOL REQUIRED  
HERRAMIENTA NECESSARIA

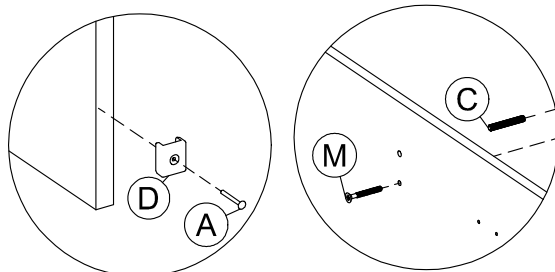
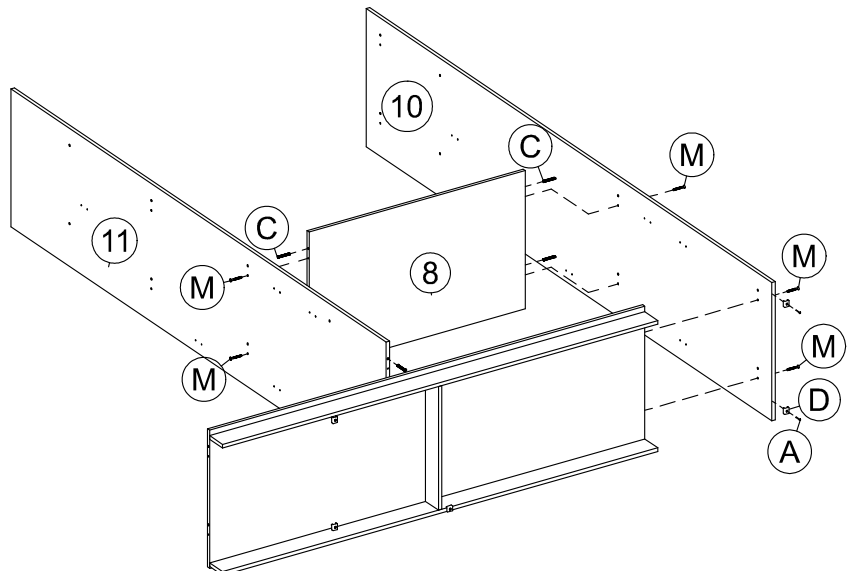
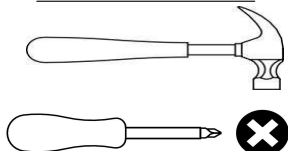

**PASSO 3**  
**STEP 3**  
**PASO 3**







PEÇAS NECESSÁRIAS  
PARTS REQUIRED  
PIEZAS NECESARIAS

INDICE	QUANT.
1	1
6	1
9	1

FERRAGEM NECESSÁRIA

HARDWARE REQUIRED

HERRAMIENTA NECESSARIA

INDICE	IMAGEM	QTDE
A		2
C		12
D		2
E		2
H		8
L		16
M		12

FERRAMENTAS NECESSÁRIAS

TOOL REQUIRED

HERRAMIENTA NECESSARIA

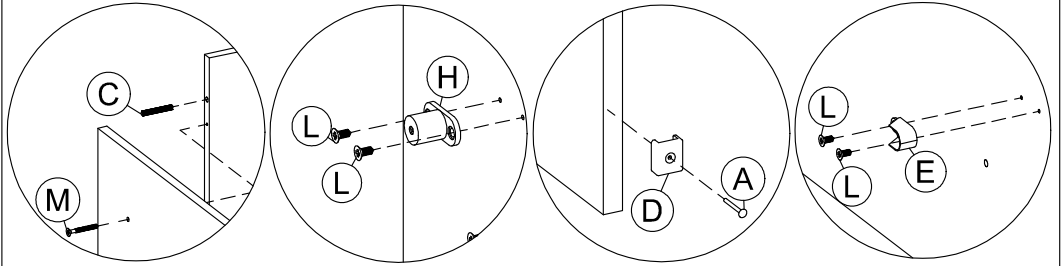
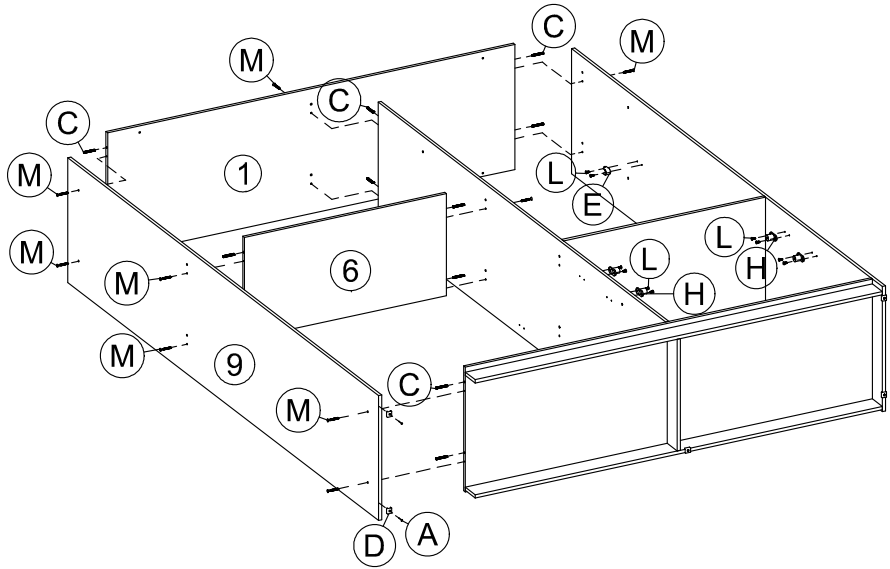
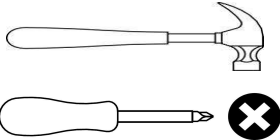

**PASSO 4**  
**STEP 4**  
**PASO 4**



PEÇAS NECESSÁRIAS  
PARTS REQUIRED  
PIEZAS NECESARIAS

INDICE	QUANT.
13	4
19	2

FERRAGEM NECESSÁRIA

HARDWARE REQUIRED

HERRAMIENTA NECESSARIA

INDICE	IMAGEM	QTDE
A		81
B		13

FERRAMENTAS NECESSÁRIAS

TOOL REQUIRED

HERRAMIENTA NECESSARIA

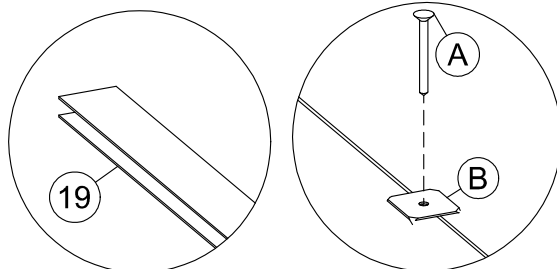
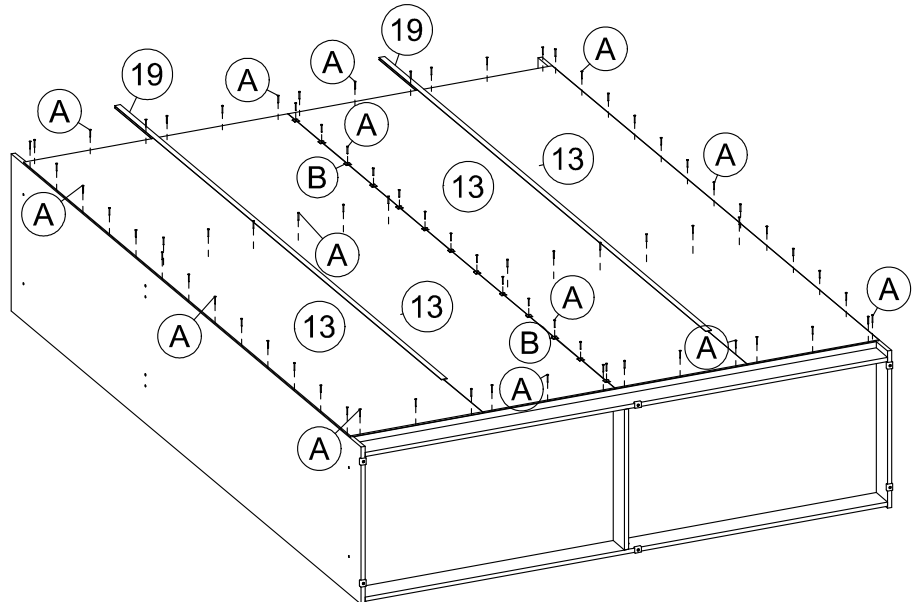
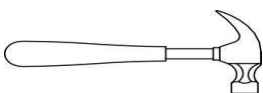





**PASSO 5  
STEP 5  
PASO 5**

PEÇAS NECESSÁRIAS  
PARTS REQUIRED  
PIEZAS NECESARIAS

INDICE	QUANT.
4	2
5	1
7	2
20	4
21	1

FERRAGEM NECESSÁRIA  
HARDWARE REQUIRED  
HERRAMIENTA NECESSARIA

INDICE	IMAGEM	QTDE
E		2
F		5
G		16
H		8
L		18

FERRAMENTAS NECESSÁRIAS  
TOOL REQUIRED  
HERRAMIENTA NECESSARIA

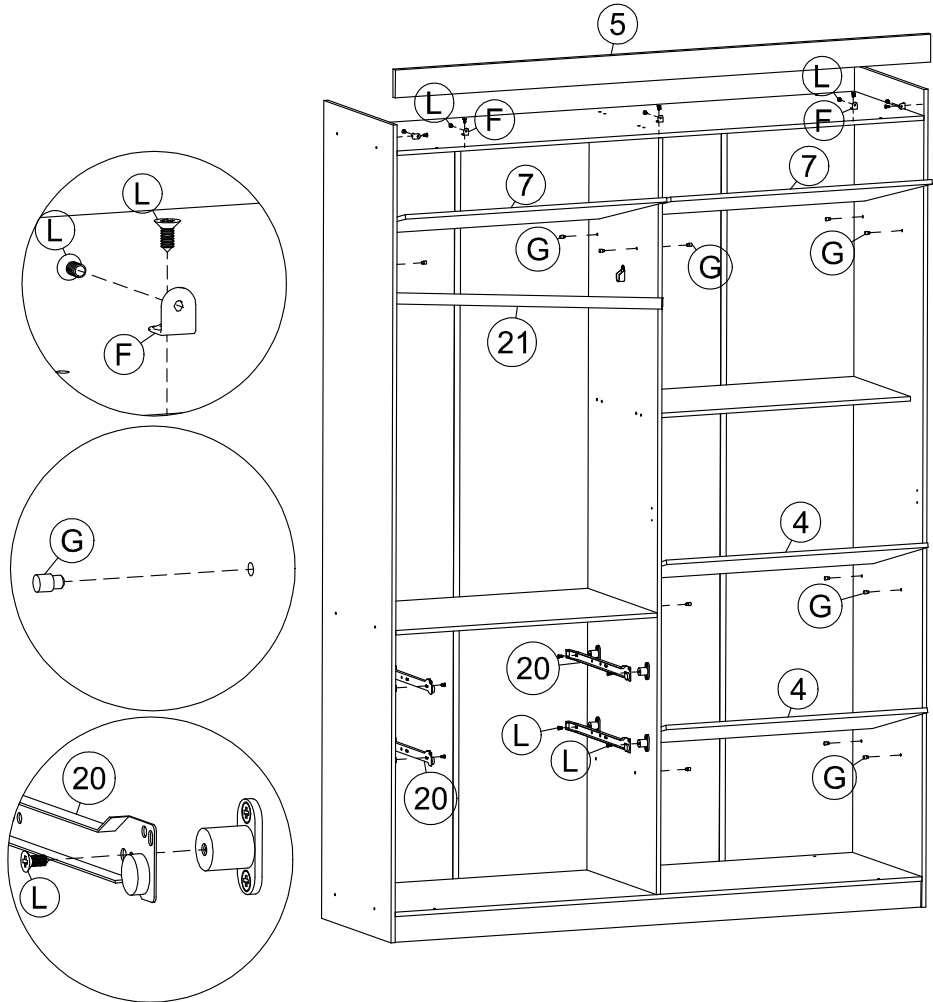
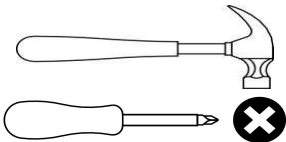





**PASSO 6  
STEP 6  
PASO 6**

PEÇAS NECESSÁRIAS  
PARTS REQUIRED  
PIEZAS NECESARIAS

INDICE	QUANT.
15	2
16	4
17	2

FERRAGEM NECESSÁRIA  
HARDWARE REQUIRED  
HERRAMIENTA NECESSARIA

INDICE	IMAGEM	QTDE
C		8
F		4
L		8
M		8

FERRAMENTAS NECESSÁRIAS  
TOOL REQUIRED  
HERRAMIENTA NECESSARIA

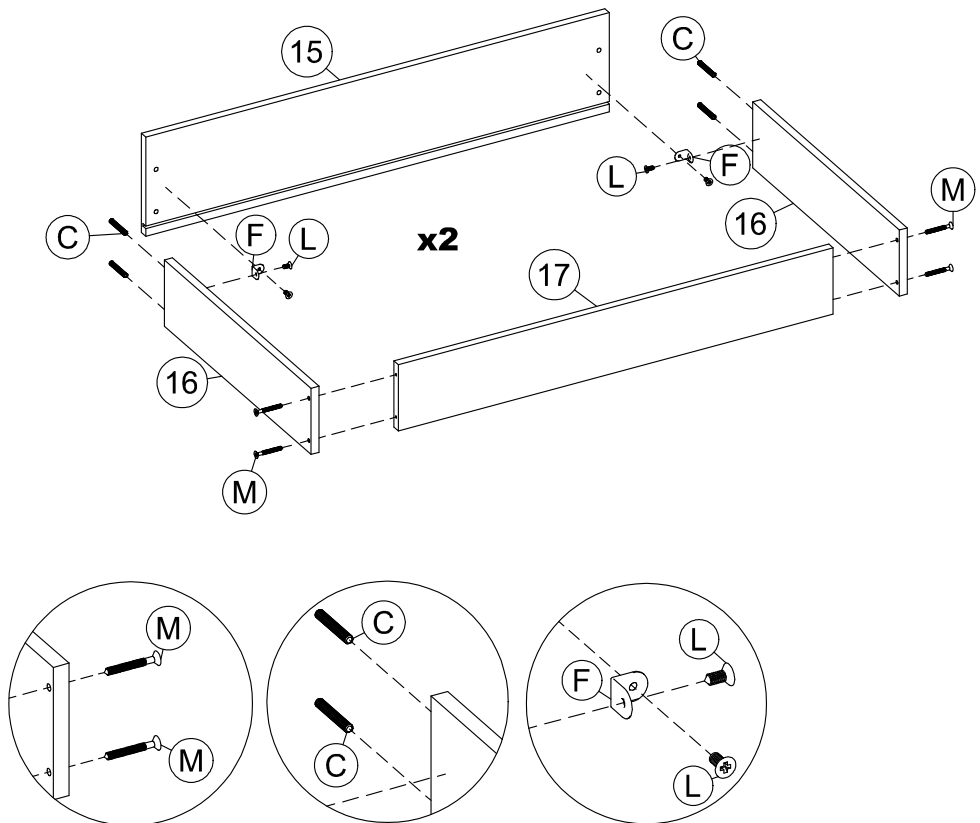
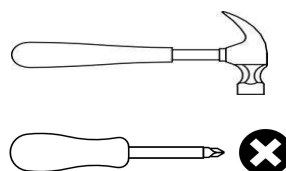



**PASSO 7  
STEP 7  
PASO 7**

PEÇAS NECESSÁRIAS  
PARTS REQUIRED  
PIEZAS NECESARIAS

INDICE	QUANT.
18	2
20	4

FERRAGEM NECESSÁRIA  
HARDWARE REQUIRED  
HERRAMIENTA NECESARIA

INDICE	IMAGEM	QTDE
A		10
K		8

FERRAMENTAS NECESSÁRIAS  
TOOL REQUIRED  
HERRAMIENTA NECESARIA

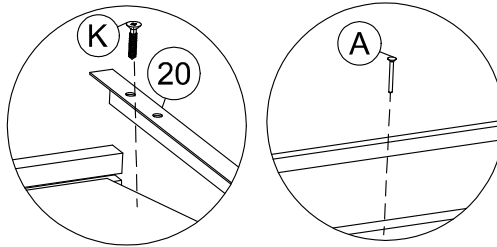
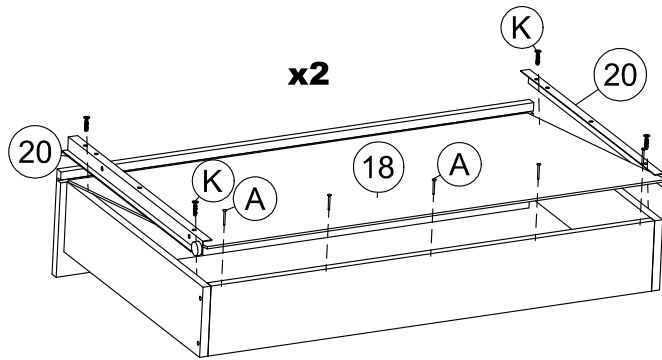
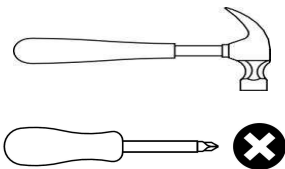





**PASSO 8  
STEP 8  
PASO 8**

PEÇAS NECESSÁRIAS  
PARTS REQUIRED  
PIEZAS NECESARIAS

INDICE	QUANT.
14	4
22	4

FERRAGEM NECESSÁRIA  
HARDWARE REQUIRED  
HERRAMIENTA NECESARIA

INDICE	IMAGEM	QTDE
J		8
L		68
P		12
Q		12

FERRAMENTAS NECESSÁRIAS  
TOOL REQUIRED  
HERRAMIENTA NECESARIA

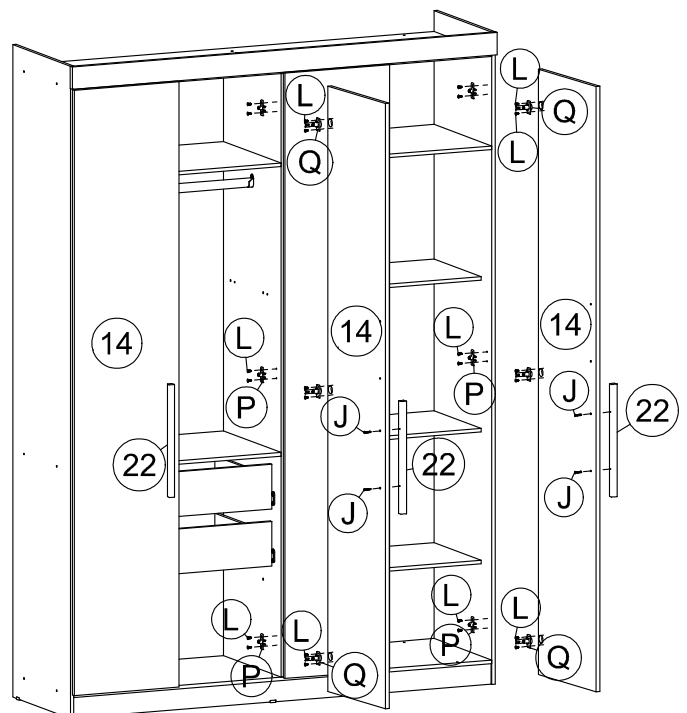
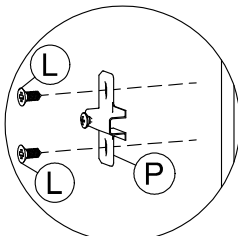
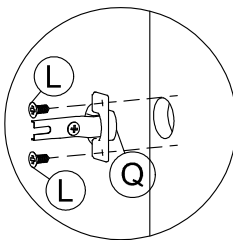
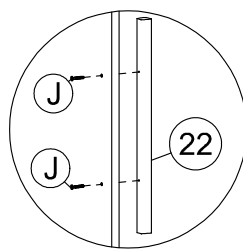
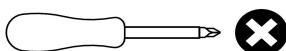

**PASSO 9**  
**STEP 9**  
**PASO 9**

PEÇAS NECESSÁRIAS  
PARTS REQUIRED  
PIEZAS NECESSARIAS

INDICE	QUANT.
R	2

FERRAGEM NECESSÁRIA  
HARDWARE REQUIRED  
HERRAMIENTA NECESSARIA

FERRAMENTAS NECESSÁRIAS  
TOOL REQUIRED  
HERRAMIENTA NECESSARIA

Montar os espelhos na porta conforme as medidas citadas abaixo.  
Assemble the mirrors on the door according to the measures mentioned below.  
Montar os espelhos na porta conforme as medidas citadas abaixo.

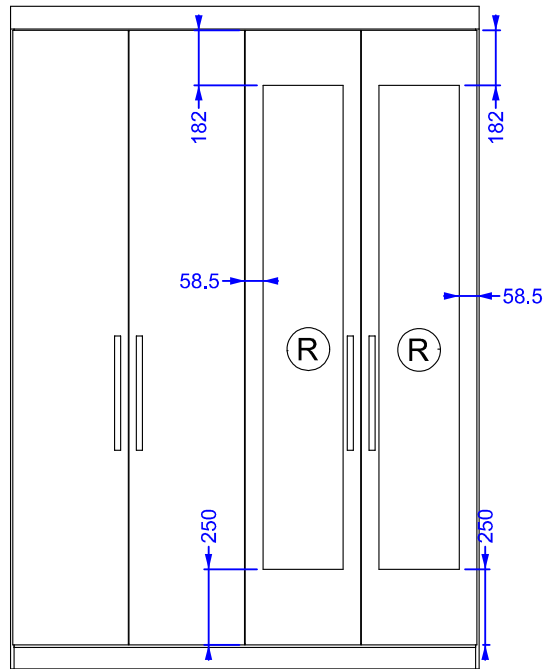

**\*Recomendamos a limpeza da porta com pano e álcool antes da fixação dos espelhos.**  
**\*We recommend cleaning the door with a cloth and alcohol before fixing two mirrors.**  
**\*Recomendamos una limpieza da porta com pano e álcool antes da fixação dos espelhos.**