

# Doripel

móveis

MANUAL DE MONTAGEM  
ASSEMBLE INSTRUCTIONS  
INSTRUCCIONES DE ARMADO

RP 60800  
RP 68500  
RP 70300  
RP 45850

Roupeiro 08 Pts

Acesse a Instrução de montagem completa pelo QRCode.

Access the complete assembly instructions via QRCode.

Accede las instrucciones de montaje completas mediante QRCode.



RP 60800

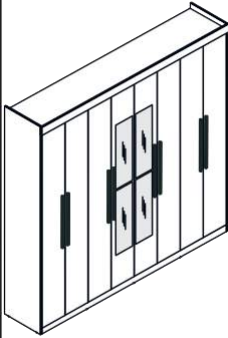

ESPELHO OPCIONAL  
OPTIONAL MIRROR  
ESPEJO OPCIONAL

RP 68500

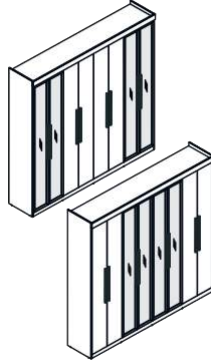

PORTA REFLECTA  
REFLECTA DOOR  
PUERTA REFLECTA

RP 70300

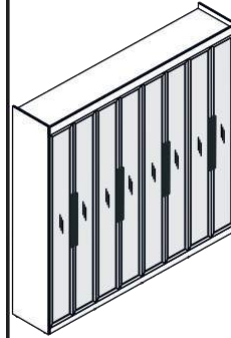

PORTA REFLECTA  
REFLECTA DOOR  
PUERTA REFLECTA

RP 45850

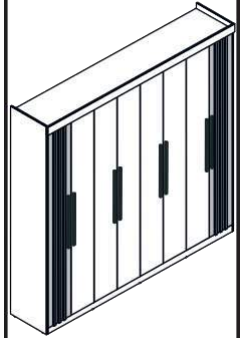

PORTA RIPADA  
SLATTED DOOR  
PUERTA RANURADA

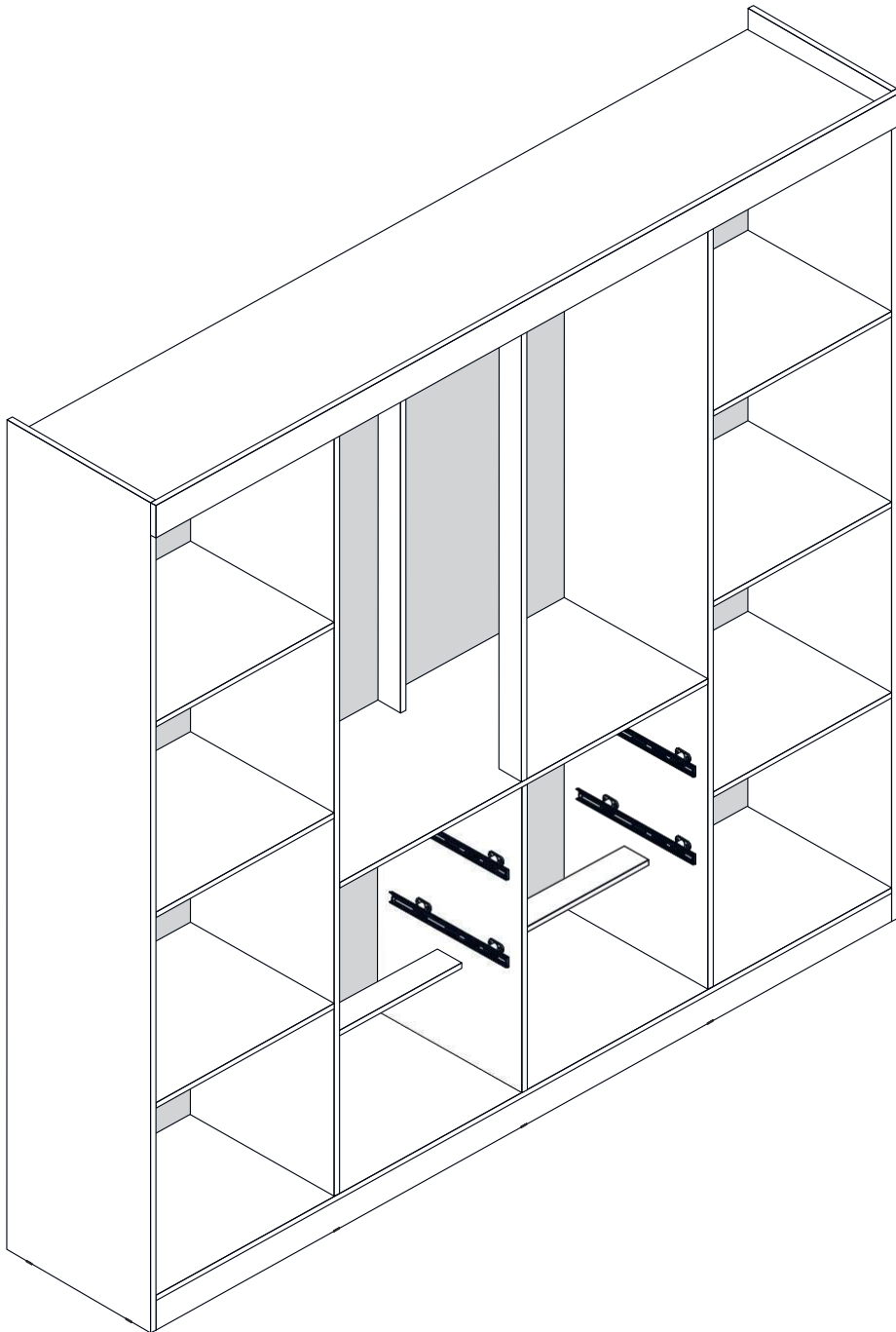

### INSTRUÇÕES DE MONTAGEM DO ROUPEIRO

- 1- Começa preparando o espaço onde vai ser montado o roupeiro. Forre o chão para que não arranhe o móvel.
  - 2- Ter as ferramentas necessárias como: parafusadeira, chave de fenda, etc.
  - 3- Abrir as caixas e conferir as peças conforme está no manual.
  - 4- Fazer a separação das peças como indicado na imagem.
  - 5- Começa pela base pelas partes menores seguindo as etapas descritas no manual.
  - 6- Montar o roupeiro deitado com a frente para baixo para facilitar o trabalho.
  - 7- As portas e gavetas serão instaladas por último.
  - 8- E por fim verifique se está tudo certo alinhado e fixado corretamente.
- Lembrando que o esquema de montagem varia entre os modelos de roupeiros.
  - É aconselhável pedir ajuda a outra pessoa para te auxiliar na hora de erguer o móvel.

### WARDROBE ASSEMBLY INSTRUCTIONS

- 1- Start by preparing the space where the wardrobe will be assembled. Cover the floor so that it does not scratch the furniture.
  - 2- Have the necessary tools such as: screwdriver, screwdriver, etc.
  - 3- Open the boxes and check the parts as shown in the manual.
  - 4- Separate the parts as shown in the image.
  - 5- Start at the base with the smallest parts following the steps described in the manual.
  - 6- Assemble the wardrobe lying face down to make the work easier.
  - 7- The doors and drawers will be installed last.
  - 8- And finally check that everything is aligned and correctly fixed.
- Remember that the assembly scheme varies between wardrobe models.
  - It is advisable to ask another person to help you when lifting the furniture.







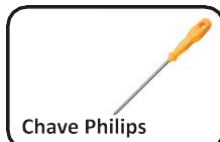



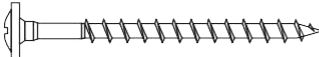
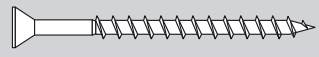

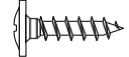





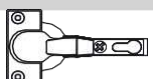

### INSTRUCCIONES DE MONTAJE DEL ARMARIO

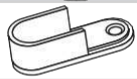
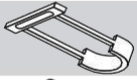
- 1- Prepare el espacio donde se montará el armario. Cubra el suelo para que no raye el mueble.
  - 2- Dispóngase de las herramientas necesarias, como destornillador, destornillador, etc.
  - 3- Abra las cajas y revise las piezas como se indica en el manual.
  - 4- Separe las piezas como se muestra en la imagen.
  - 5- Comience por la base con las piezas más pequeñas siguiendo los pasos descritos en el manual.
  - 6- Monte el armario boca abajo para facilitar el trabajo.
  - 7- Las puertas y los cajones se instalarán en último lugar.
  - 8- Por último, compruebe que todo esté alineado y correctamente fijado.
- Recuerde que el esquema de montaje varía según el modelo de armario.
  - Se recomienda pedir ayuda a otra persona para levantar el mueble.

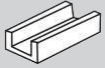
MATERIAL PARA MONTAGEM | ASSEMBLY MATERIAL | MATERIAL PARA ARMADO

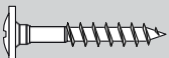
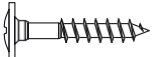

# FERRAGEM | HARDWARE | HERRAJES

<b>A</b>	<b>PARAFUSO FLANGEADO 3,5x40</b> FLANGE SCREW 3,5x40 TORNILLO FLANGEADO 3,5x40		<b>51</b>
<b>B</b>	<b>PARAFUSO 3,5x40</b> SCREW 3,5x40 TORNILLO FLANGEADO 3,5x40		<b>03</b>
<b>C</b>	<b>PARAFUSO FLANGEADO 3,5x25</b> FLANGE SCREW 3,5x25 TORNILLO FLANGEADO 3,5x25		<b>16</b>
<b>D</b>	<b>KIT FIXADOR ESPELHO</b> MIRROR FIXING KIT KIT FIJACION ESPEJO		<b>01</b>
<b>E</b>	<b>PARAFUSO FLANGEADO 3,5x12</b> FLANGE SCREW 3,5x12 TORNILLO FLANGEADO 3,5x12		<b>220</b>
<b>F</b>	<b>PARAFUSO 3,5x16</b> SCREW 3,5x16 TORNILLO 3,5x16		<b>16</b>
<b>G</b>	<b>FIXADOR</b> FIXER FIJADOR		<b>20</b>
<b>H</b>	<b>CANTONEIRA 18x18</b> 15x15 CORNER ESQUINA 15x15		<b>20</b>
<b>I</b>	<b>CAVILHA 6x30</b> 6x30 PEGS TACOS 6x30		<b>19</b>
<b>J</b>	<b>CAVILHA 6x50</b> 6x50 PEGS TACOS 6x50		<b>03</b>
<b>K</b>	<b>PREGO 10x10 C/C</b> NAIL 10x10 CLAVO 10x10		<b>152</b>
<b>L</b>	<b>PREGO 13x15 C/C</b> NAIL 13x15 CLAVO 13x15		<b>16</b>
<b>M</b>	<b>DOBRADIÇA</b> HINGE BISAGRA		<b>32</b>
<b>N</b>	<b>CALÇO DOBRADIÇA</b> HINGE MOUNTING PLATE BASE DE BISAGRA		<b>32</b>
<b>O</b>	<b>SUPORE CABIDEIRO</b> HANGER SUPPORT APOYO PERCHERO		<b>02</b>
<b>P</b>	<b>SUPORE CENTRAL</b> CENTER SUPPORT APOYO CENTRAL		<b>01</b>
<b>Q</b>	<b>DISTANCIADOR 32mm</b> 32mm DISTANCER DISTANCIADOR 32mm		<b>16</b>
<b>R</b>	<b>SAPATA</b> SHOE ZAPATA		<b>10</b>
<b>S</b>	<b>SUPORE PRATELEIRA</b> SHELF SUPPORT SOPORTE ESTANTE		<b>16</b>
<b>T</b>	<b>COLA</b> GLUES PEGAMENTO		<b>01</b>
<b>U</b>	<b>CABIDEIRO</b> HANGER PERCHERO		<b>01</b>
<b>V</b>	<b>PUXADOR</b> HANDLE TIRADOR		<b>08</b>
<b>W</b>	<b>CORREDIÇA</b> SLIDER CORREDIZA		<b>04</b>
<b>X</b>	<b>PARAFUSO 3,5x25 FLANGEADO (RIPADO)</b> 3,5x25 FLANGE SCREW (SLATTED) TORNILLO 3,5x25 FLANGEADO (RANURADO)		<b>24</b>
<b>Z</b>	<b>PARAFUSO FLANGEADO 3,5x20</b> FLANGE SCREW 3,5x20 TORNILLO FLANGEADO 3,5x20		<b>02</b>



UTILIZE A RÉGUA PARA A MEDIÇÃO DOS PARAFUSOS | USE THE RULER TO MEASURE THE SCREWS | USA LA REGLA PARA MEDIR LOS TORNILLOS

LISTA DE PEÇAS | PARTS LIST | LISTA DE PIEZAS

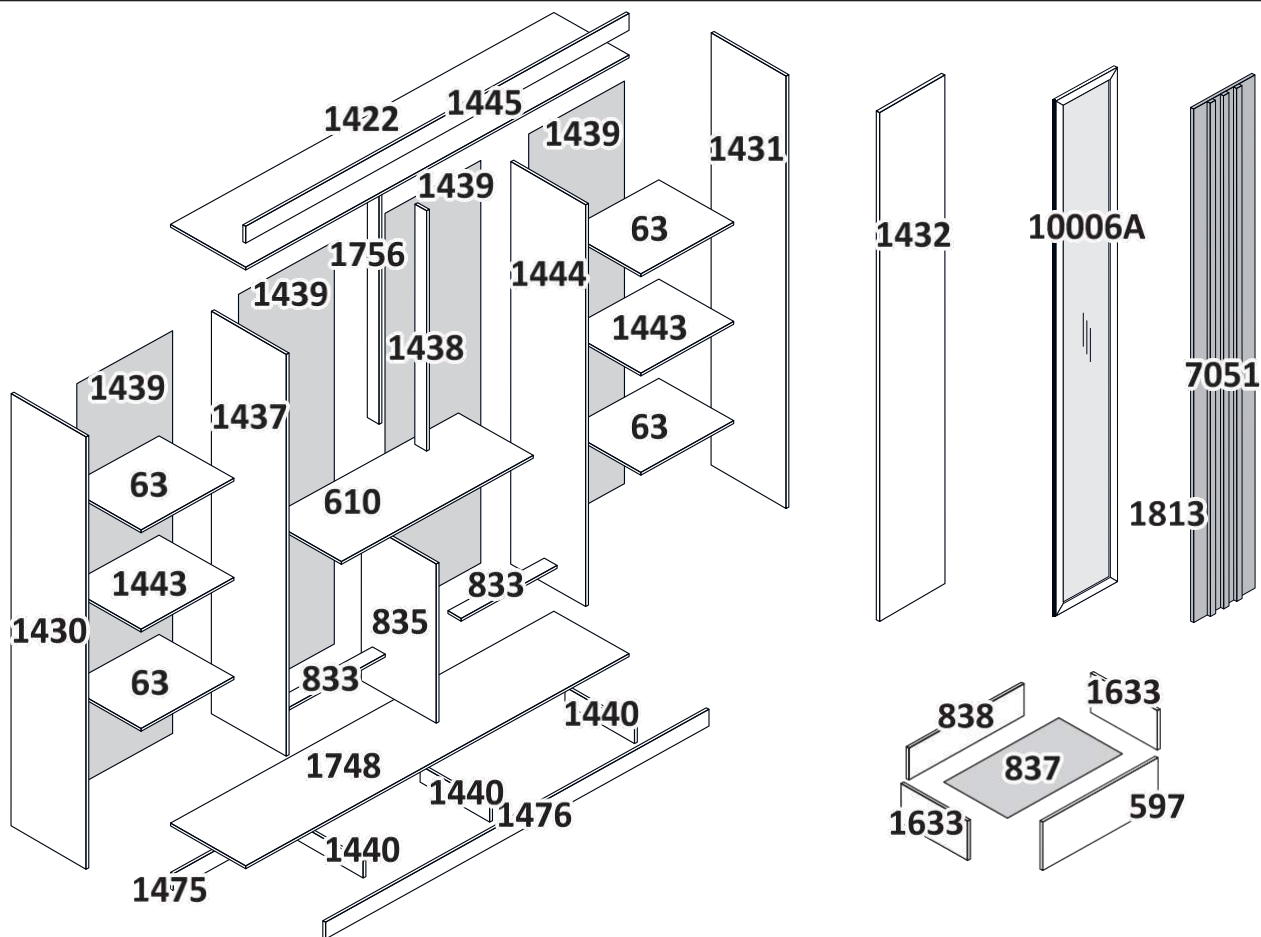

CÓDIGO CODE CODIGO	DESCRIÇÃO DESCRIPTION DESCRIPCIÓN	QTD. QUANTITY CANTIDAD	DIMENSÕES		CHAPA PLATE   LÁMINA
			COMP. LENGTH   LONGITUD	LARG. WIDTH   ANCHO	
1431	LATERAL DIREITA RIGHT SIDE / LATERAL DERECHA	01	2,170	0,450	12mm
1422	TAMPO SUPERIOR TOP PANEL / TAPA SUPERIOR	01	2,396	0,450	12mm
1430	LATERAL ESQUERDA LEFT SIDE / LATERAL IZQUIER	01	2,170	0,450	12mm
1476	RODAPÉ FRONTAL D-FRONT BASEBOARD / ZÓCALO FRONTAL	01	2,396	0,150	15mm
1475	RODAPÉ TRASEIRO BACK BASEBOARD / ZÓCALO TRASERO	01	2,396	0,150	15mm
1445	RODA FORRO BACKING PANEL / PANEL DE RESPALDO	01	2,420	0,105	15mm
1432	PORTA DOOR / PUERTA	08	1,915	0,298	15mm
1439	COSTAS BACK / TRASERA	04	1,920	0,603	3mm
0610	TAMPO CENTRAL CENTRAL PANEL / TAPA CENTRAL	01	1,192	0,450	12mm
0835	DIVISÓRIA CENTRAL CENTRAL DIVIDER / DIVISION CENTRAL	01	0,800	0,450	12mm
0063	PRATELEIRA MÓVEL ADJUSTABLE SHELF / REPISA MÓVIL	04	0,590	0,330	12mm
1443	PRATELEIRA FURADA PERFORATED SHELF / REPISA PERFORADA	02	0,590	0,330	12mm
0597	FRENTE GAVETA DRAWER FRONT / FRENTE DE CAJÓN	04	0,525	0,158	12mm
0838	TRASEIRO GAVETA DRAWER BACK / PARTE TRASERA DE CAJÓN	04	0,475	0,070	12mm
1438	PILAstra FRONTAL FRONT PILASTER / PILASTRA FRONTAL	01	1,084	0,100	12mm
1756	PILAstra TRASEIRA BACK PILASTER / PILASTRA TRASERA	01	1,084	0,100	12mm
1633	LATERAL GAVETA DRAWER SIDE / LATERAL DE CAJÓN	08	0,320	0,085	12mm
0833	TRAVESSA CROSSBAR / TRAVESAÑO	02	0,590	0,070	15mm
1437	DIVISÓRIA ESQUERDA LEFT DIVIDER / DIVISION IZQUIERDA	01	1,896	0,450	12mm
1444	DIVISÓRIA DIREITA RIGHT DIVIDER / DIVISION DERECHA	01	1,896	0,450	12mm
1440	RODAPÉ CENTRAL CENTRAL BASEBOARD / ZÓCALO CENTRAL	03	0,402	0,150	15mm
0837	FUNDO GAVETA DRAWER BOTTOM / FONDO DE CAJÓN	04	0,327	0,495	3mm
1748	TAMPO INFERIOR BOTTOM PANEL / TAPA INFERIOR	01	2,396	0,450	12mm
10006A	PORTA REFLECTA REFLECTA DOOR / PUERTA REFLECTA	DE ACORDO C/ O MODELO	1,915	0,298	15mm
7051	RIPADO SLATTED / RANURADO	06	1,915	0,025	12mm
1813	PORTA RIPADO SLATTED DOOR / PUERTA RANURADO	02	1,915	0,298	15mm

# Montar Rodapé.

Assembly Baseboard.

Montaje Zócalo.

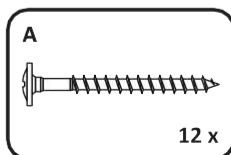
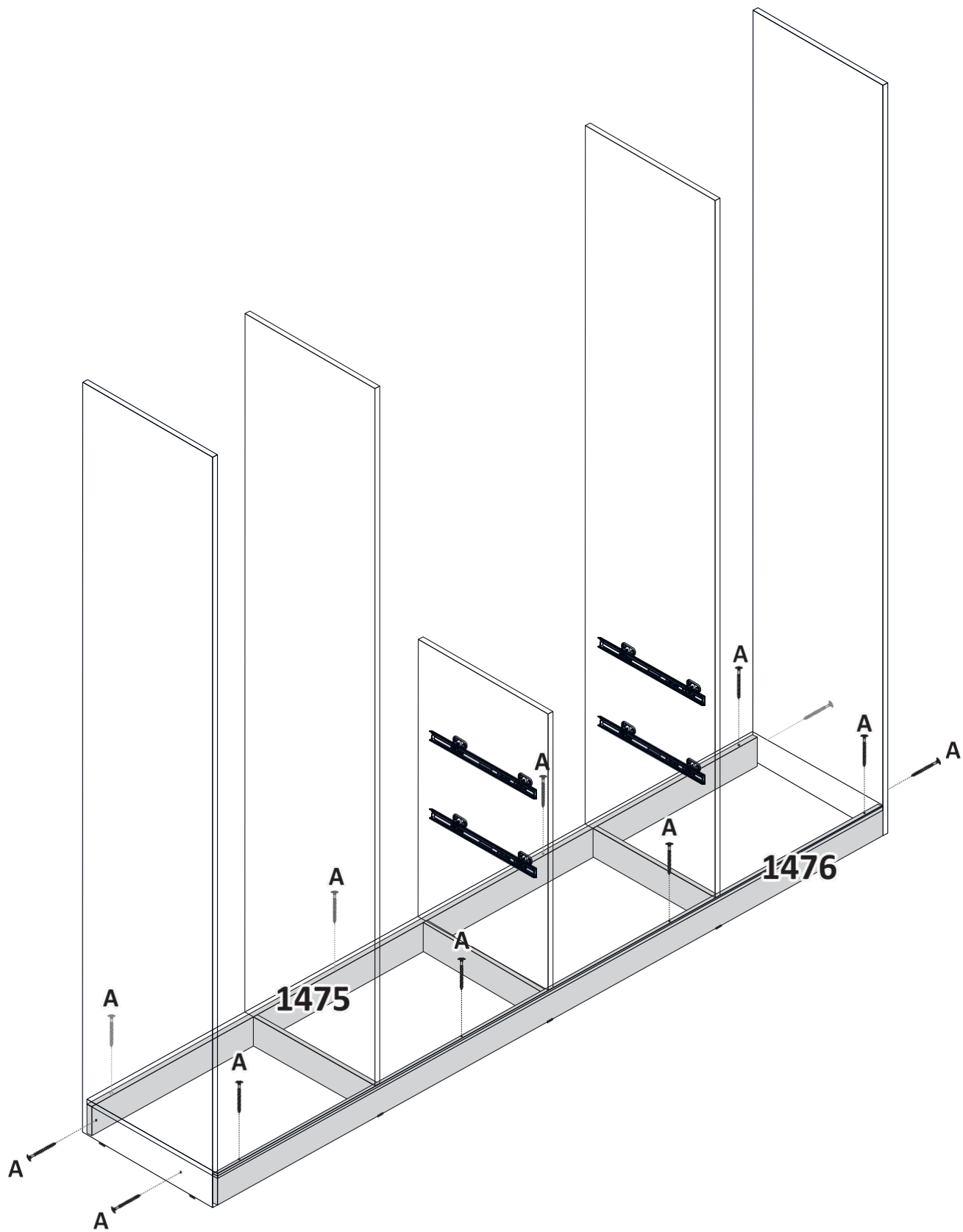

# Preparando Tampo Central.

Preparing Central Panel.  
Preparando Tapa Central

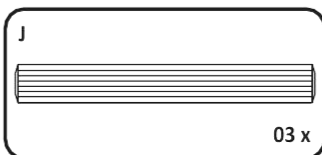
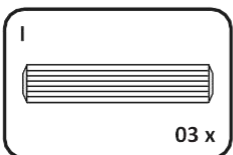
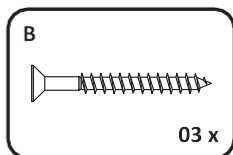
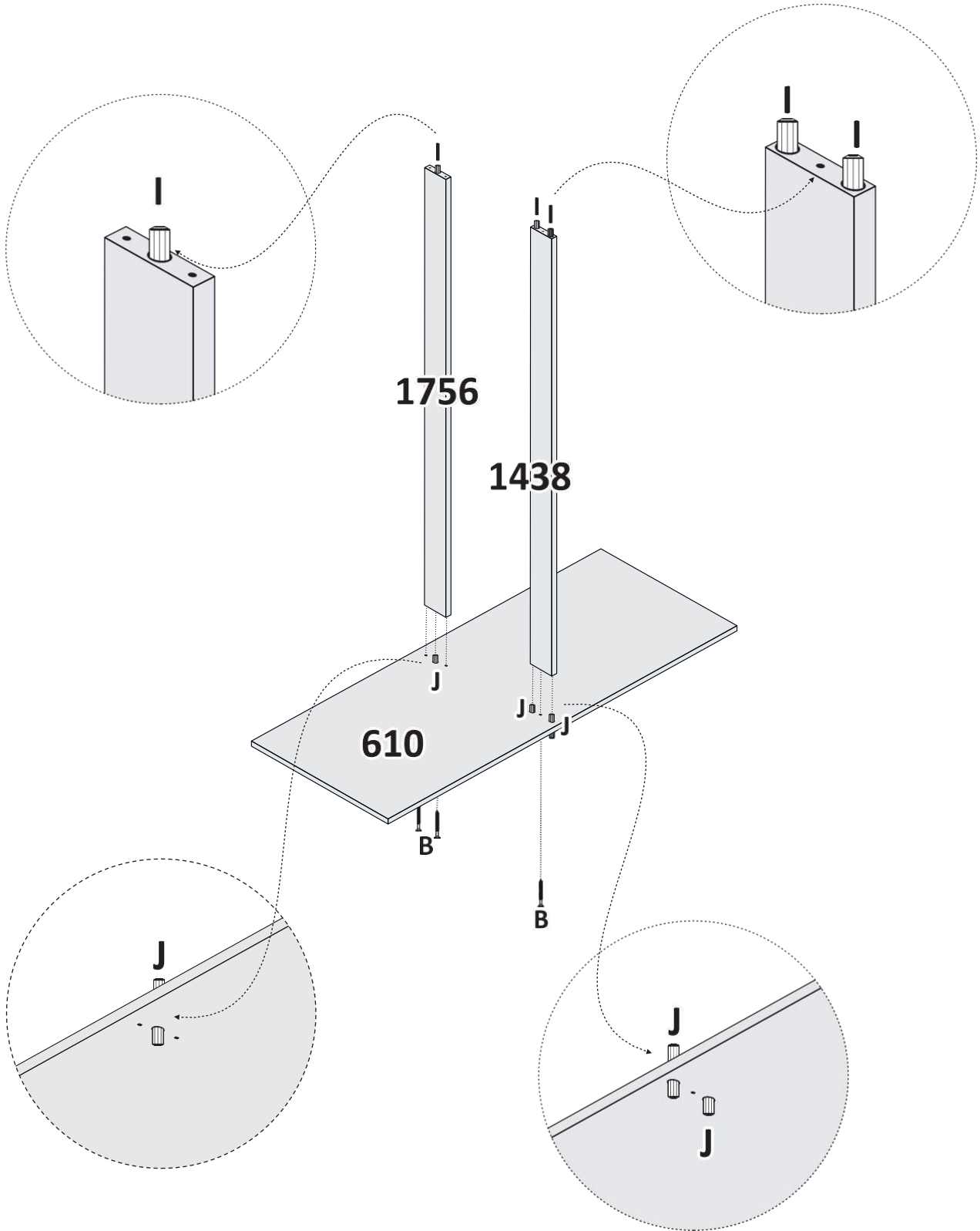

# Montando Tampo Central.

Assembly Central Panel.  
Montaje Tapa Central.

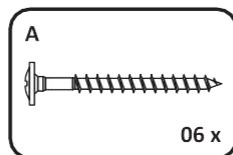
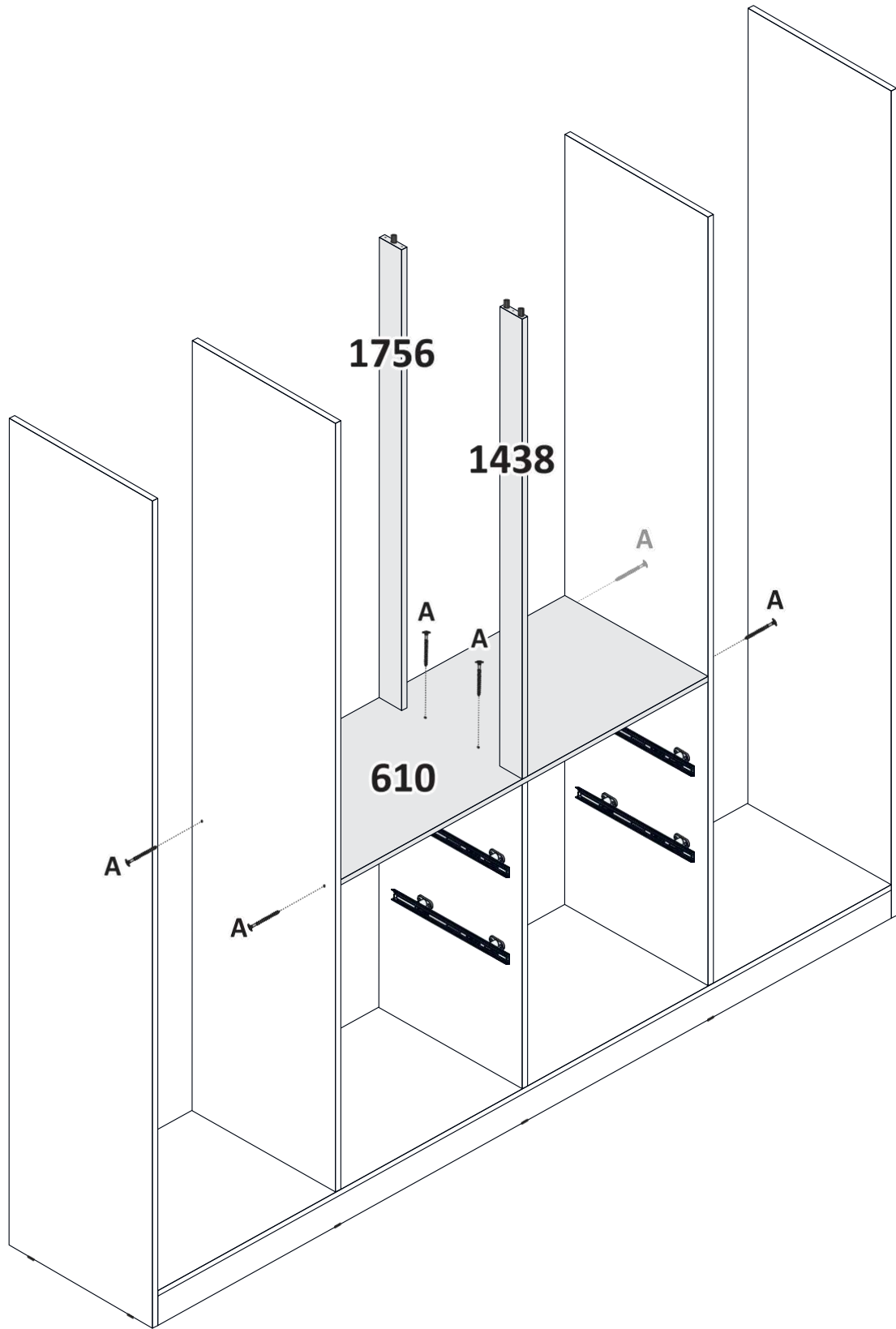

# Montando Prateleiras Furadas e Travessas.

Assembling Perforated Shelves and Crossbars.  
Montaje de Estantes Perforados y Travesaños.

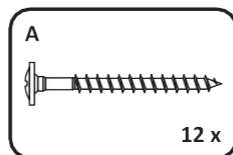
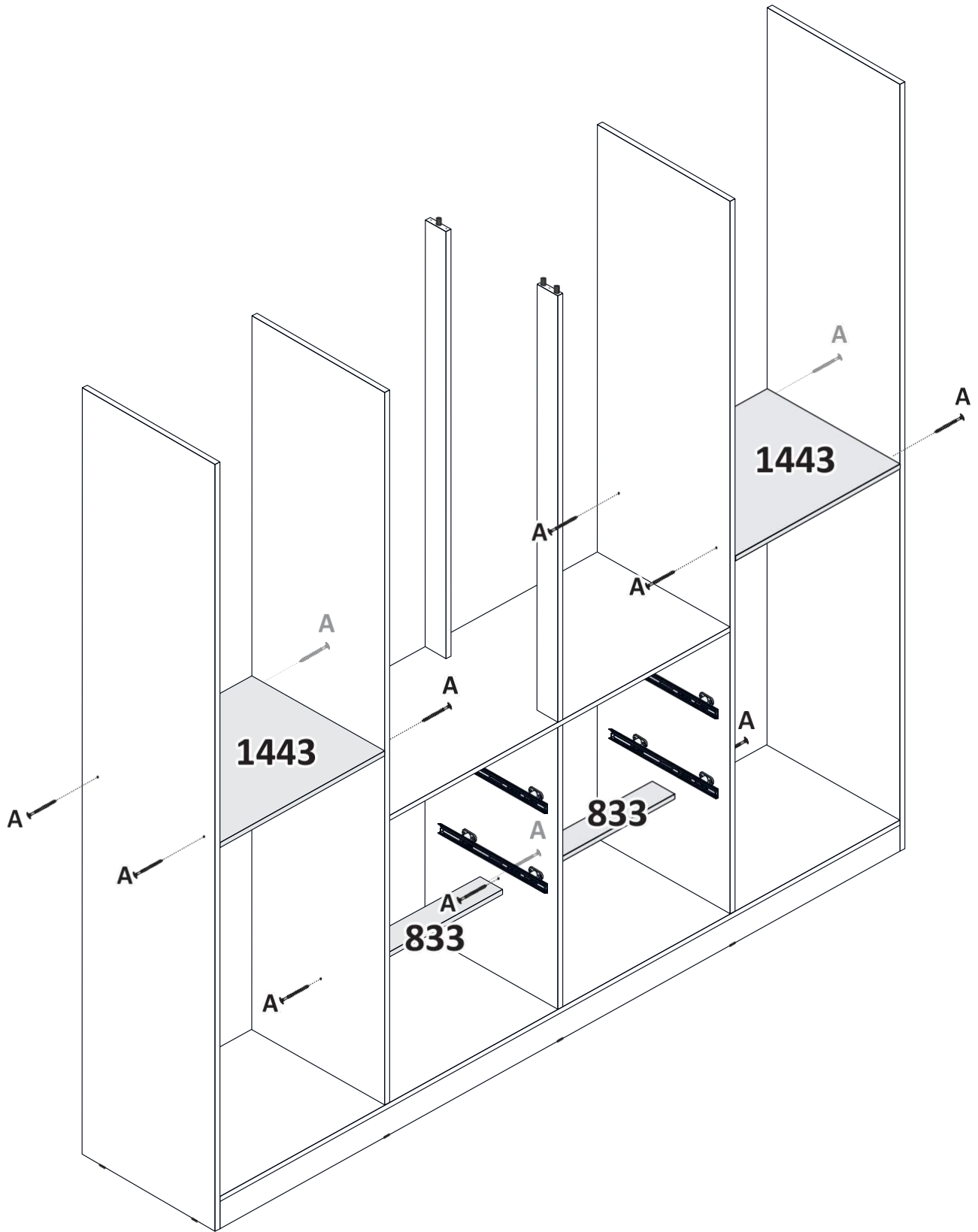

# Montagem Tampo.

Hive Top.  
Estante Tapa.

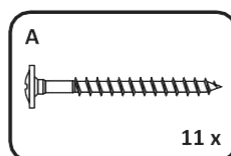
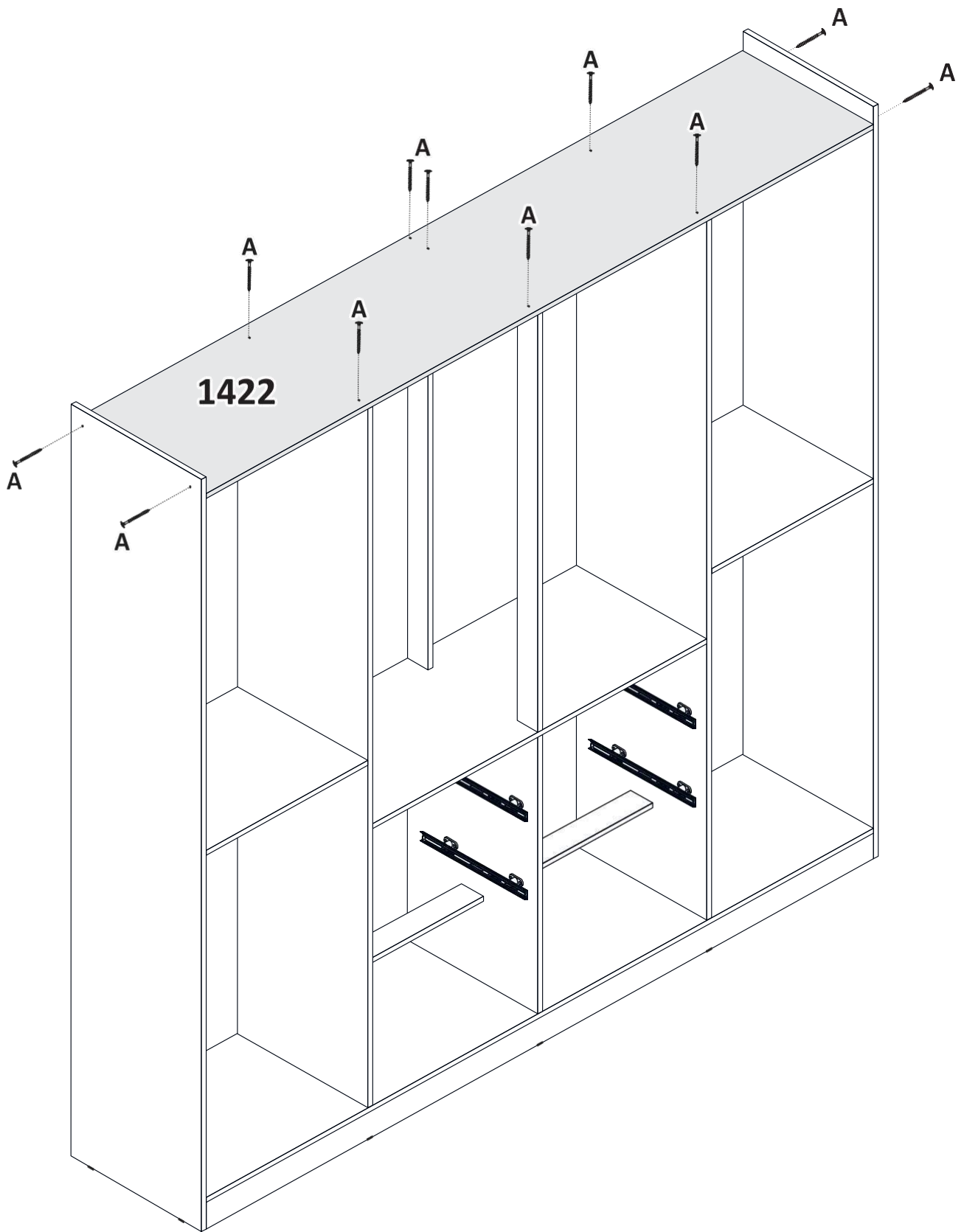

# Montagem Rodaforro.

Assembly Rodaforro.  
Montaje de Rodaforro.

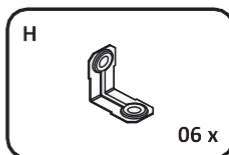
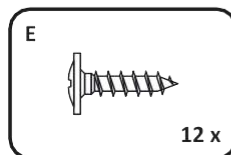
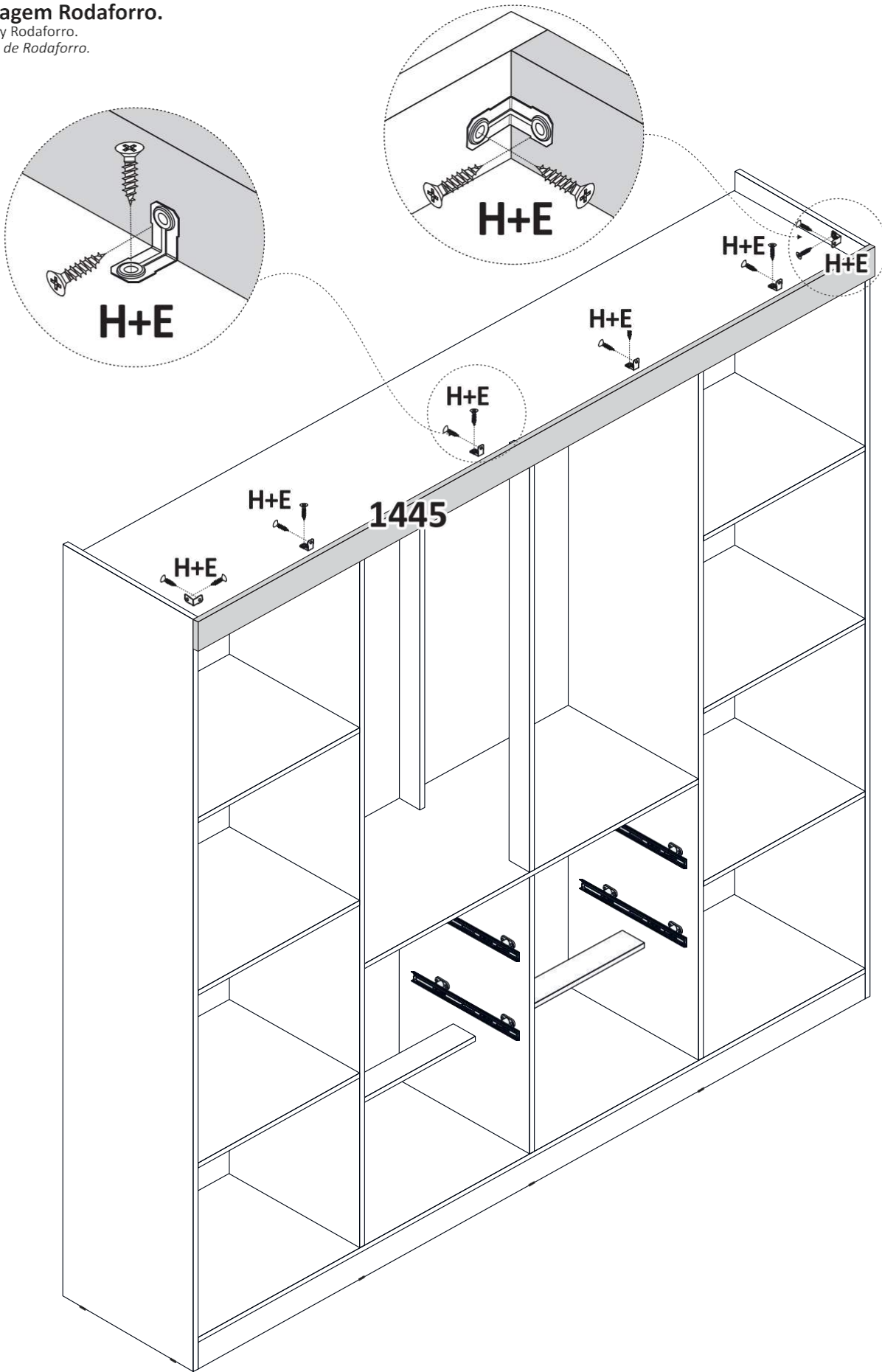

# Montagem das Costas.

Back Assembly.  
Montaje Trasero.

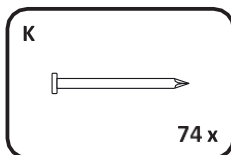
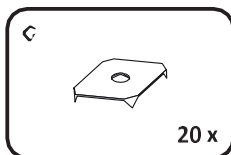
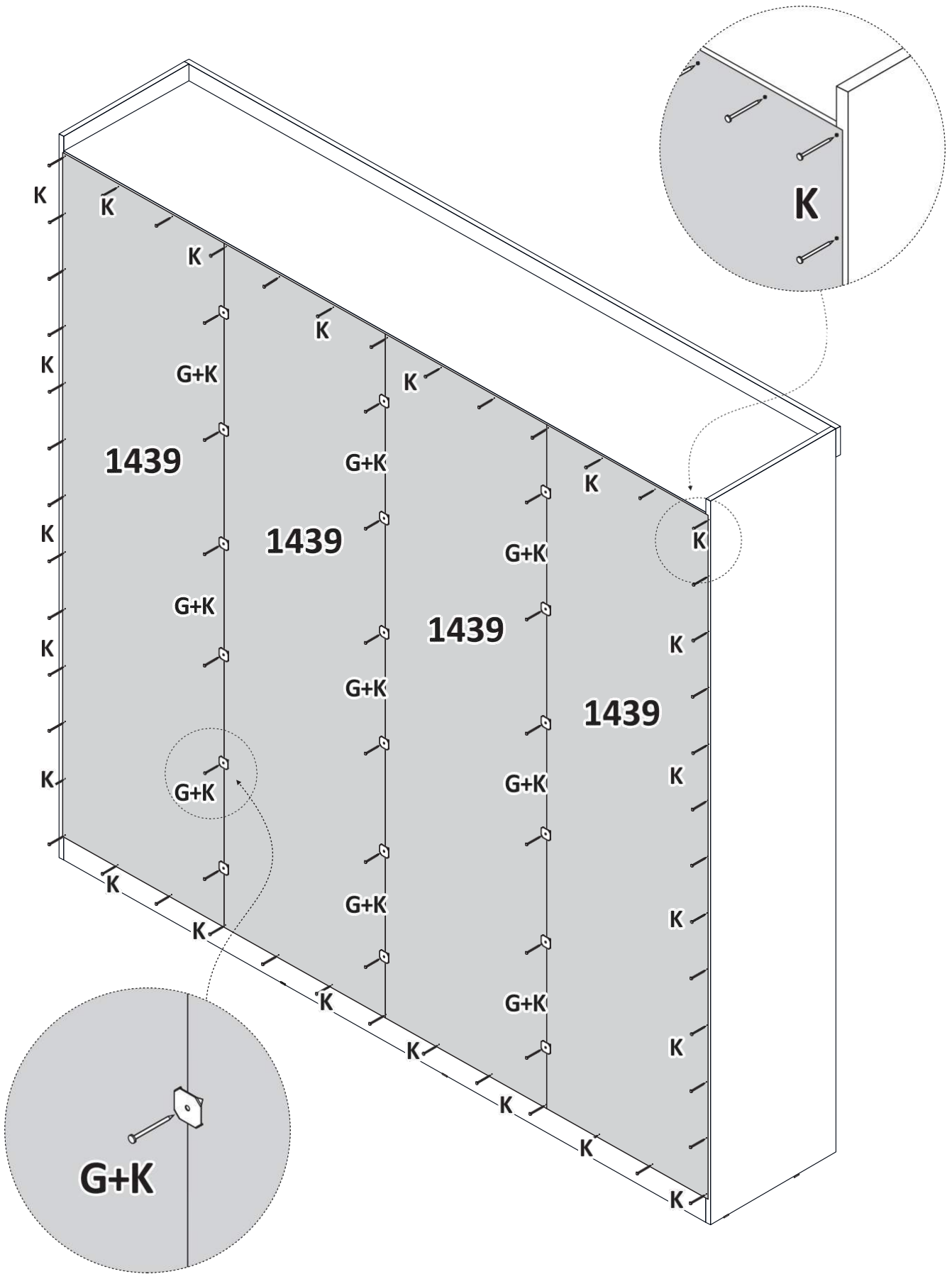

# Montar Prateleiras Móveis.

Assemble Mobile Shelves.  
Montar Estantes Móveis.

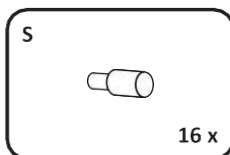
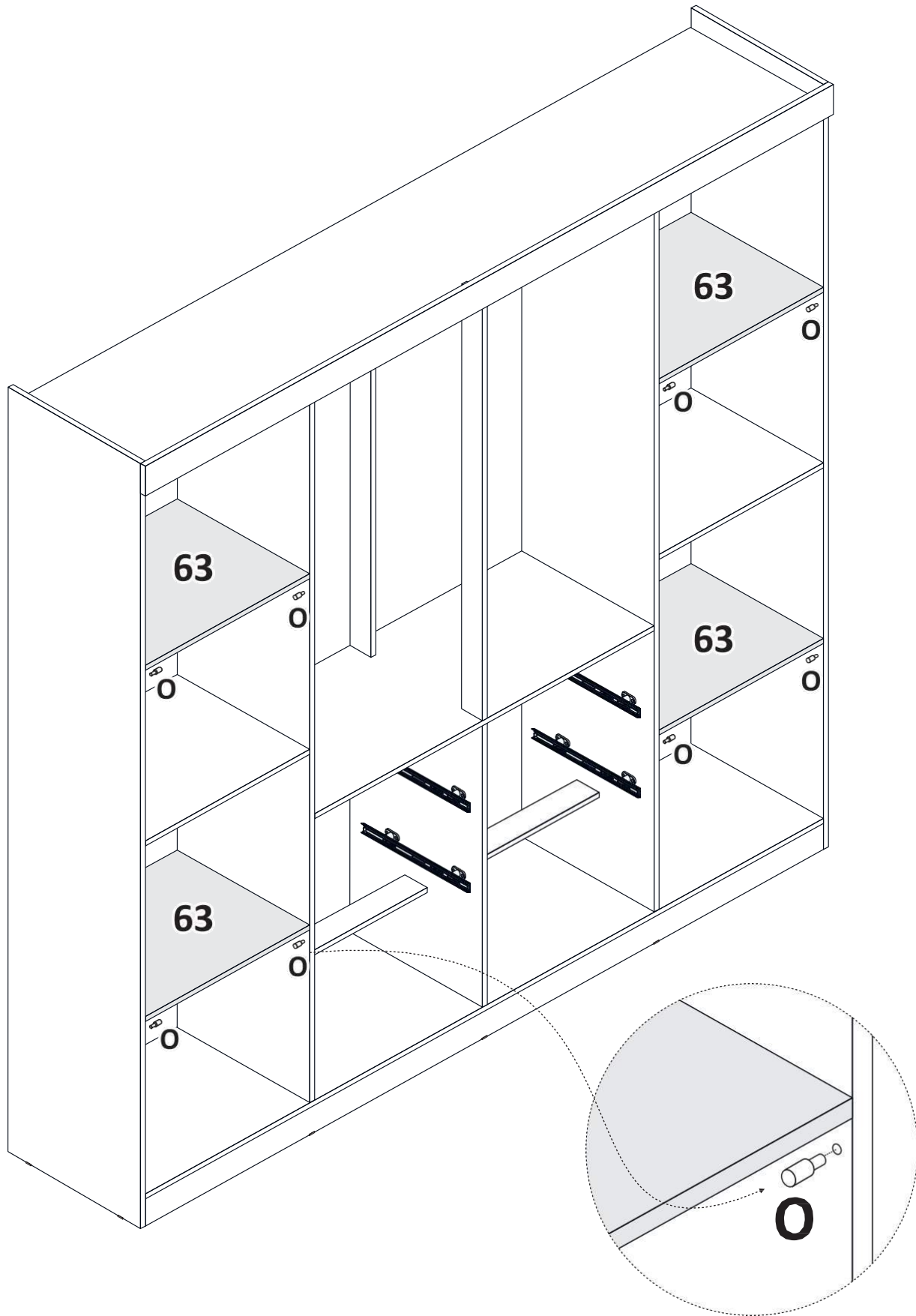

## Montar Cabideiro.

Assemble Clothes Rack.  
Montar Perchero.

### PRIMEIRO MONTAR O SUPORTE CENTRAL, SÓ DEPOIS OS SUPORTES LATERAIS.

FIRST ASSEMBLE THE CENTER SUPPORT, ONLY THEN THE SIDE SUPPORTS.

PRIMERO MONTE EL SOPORTE CENTRAL, SÓ DESPUÉS LOS SOPORTES LATERALES.

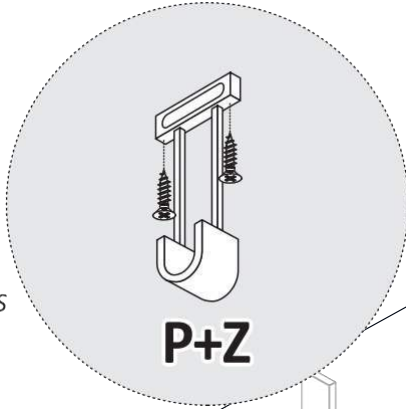

**P+Z**

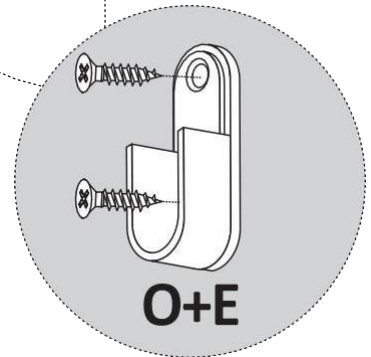
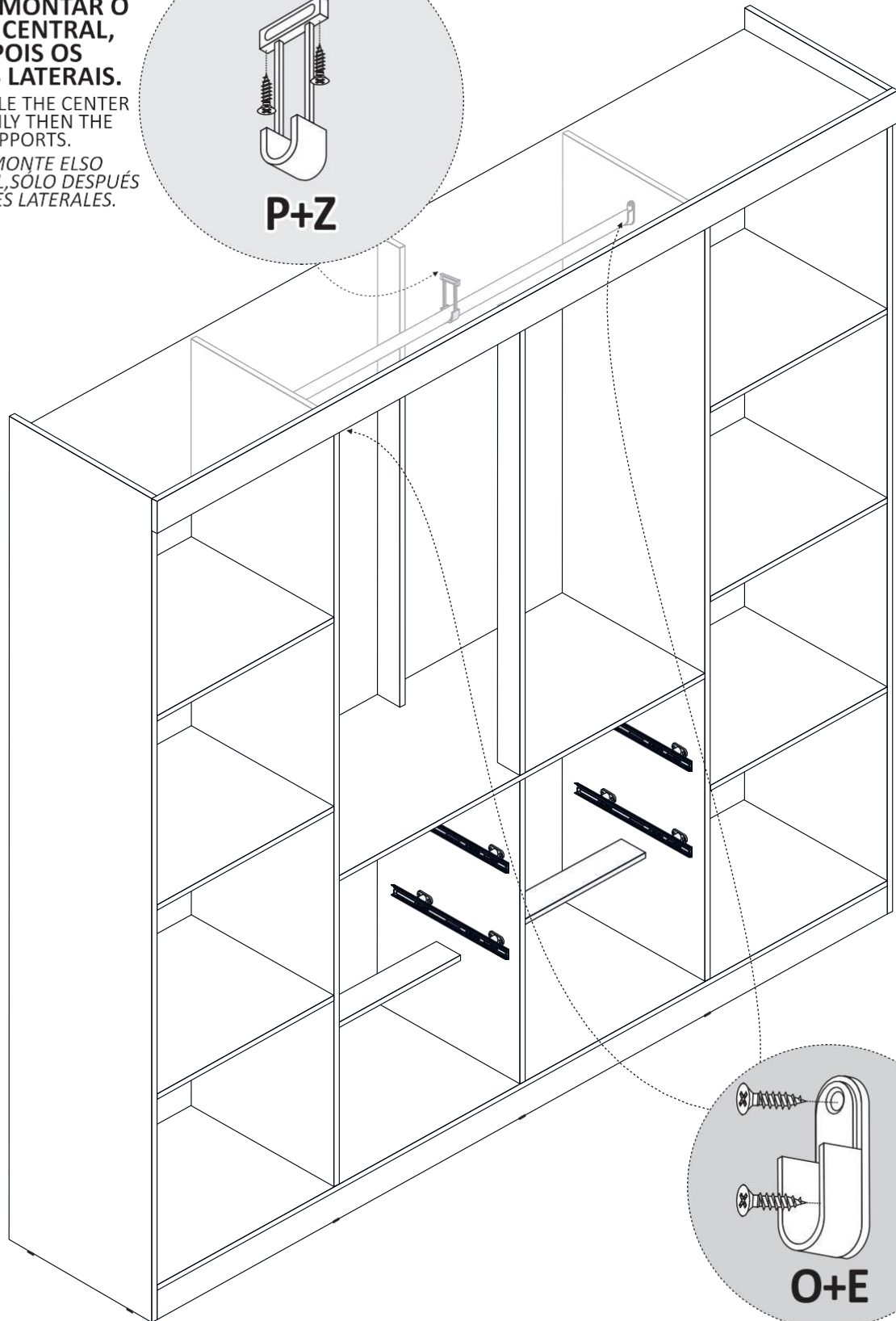

**O+E**

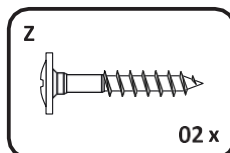
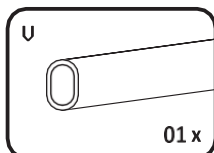
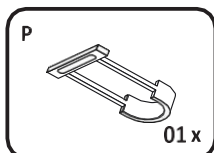
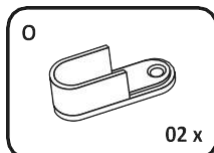
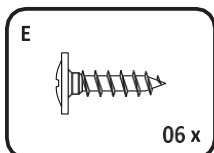

**Peso suportado em cada parte.**

Weight supported on each part.

Peso soportado en cada parte.

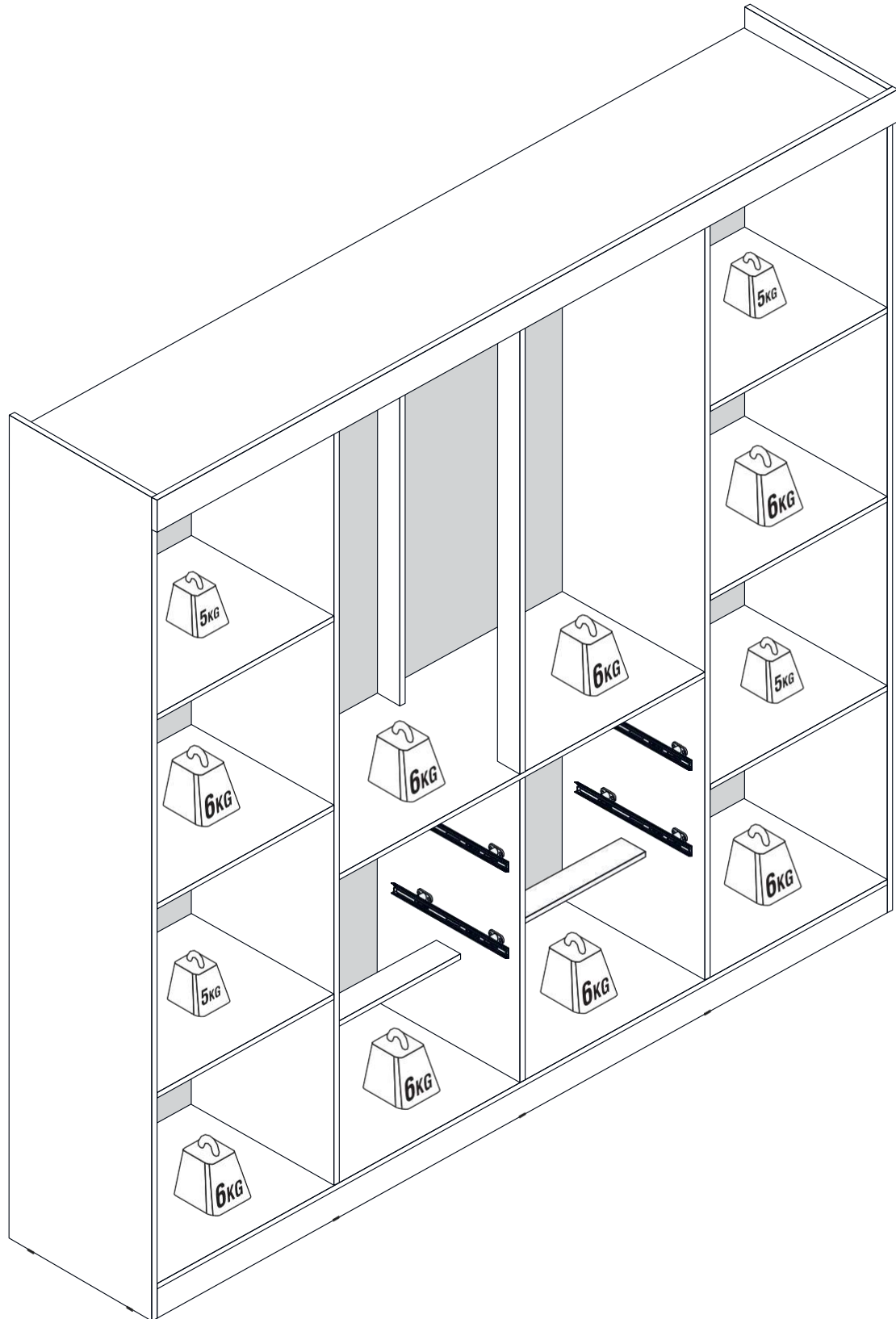



# Montagem Porta Esquerda.

Left Door Assembly.

Montaje de la Puerta Izquierda.

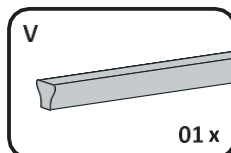
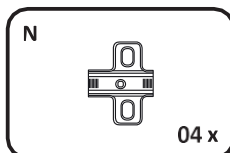
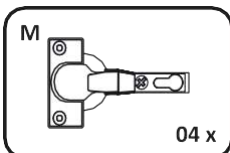
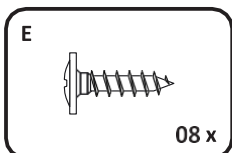
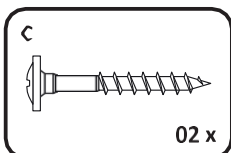
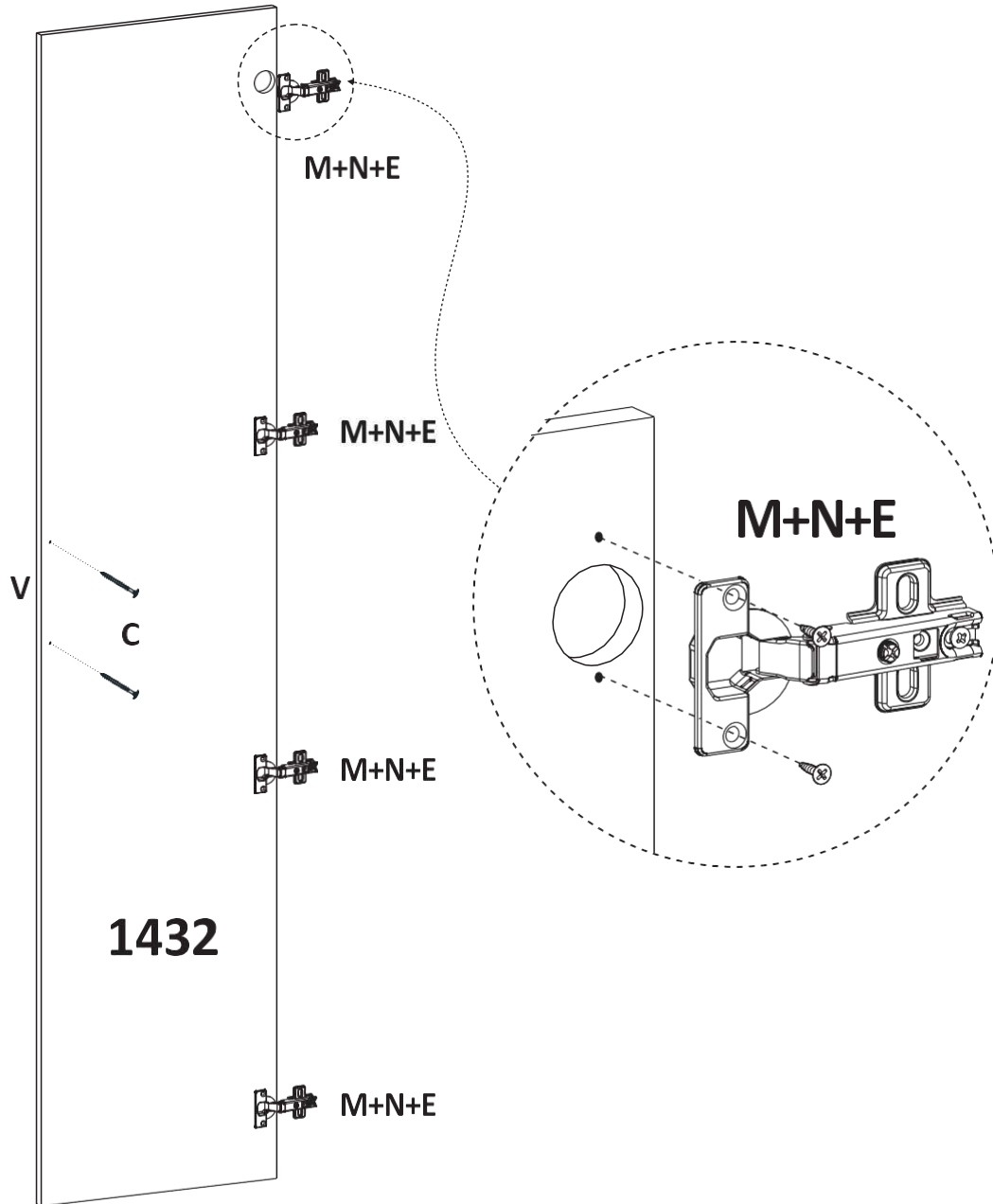

# Montagem Porta Direita.

Right Door Assembly.

Montaje de la Puerta Derecha.

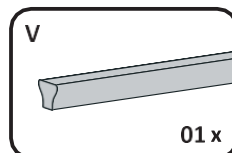
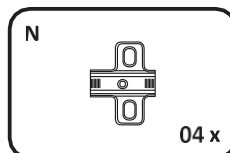
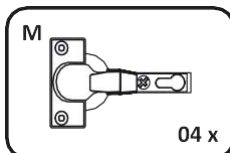
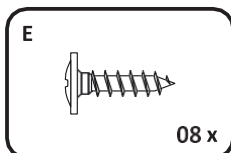
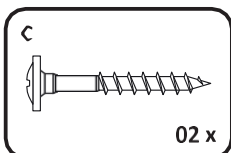
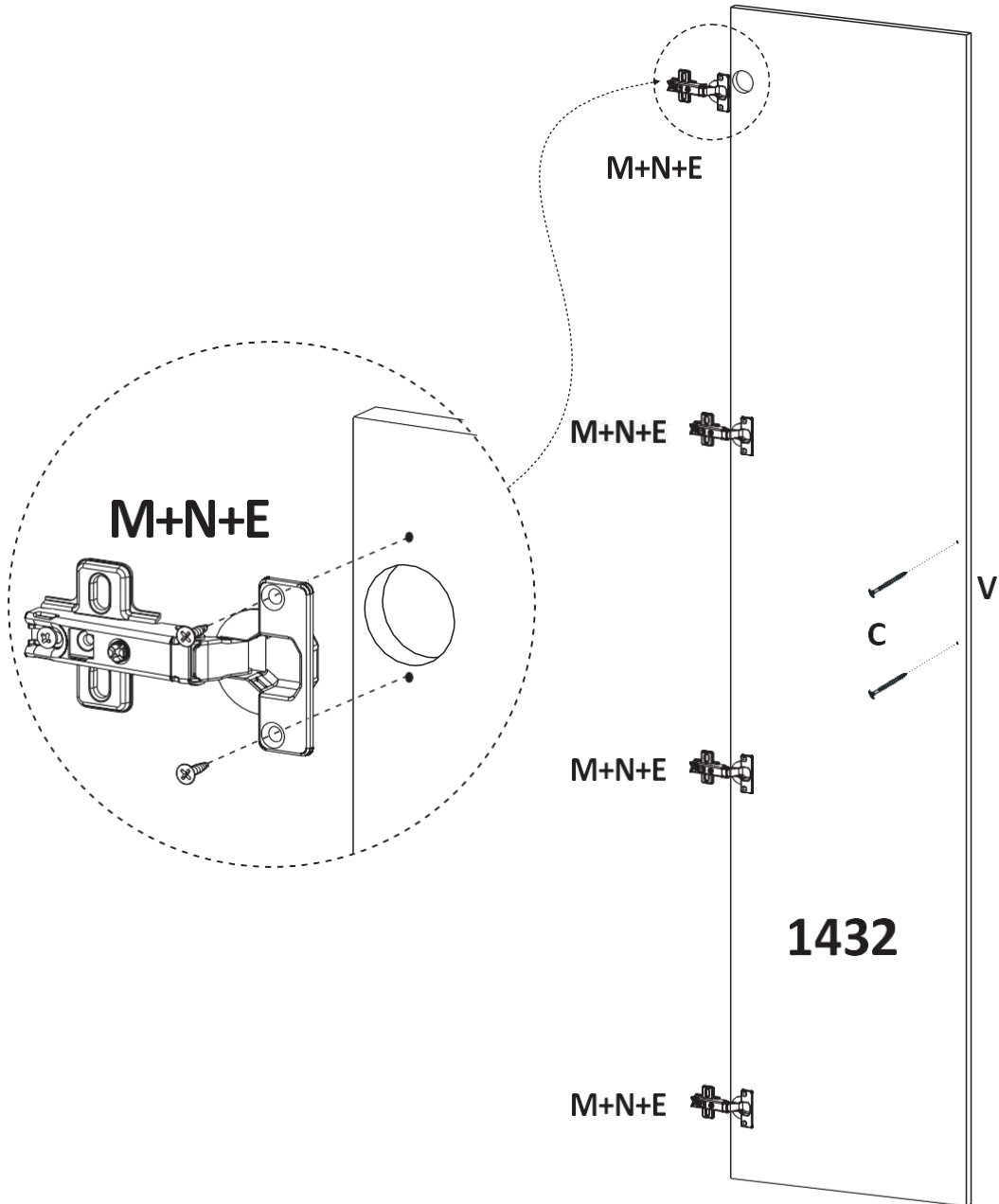

## Montagem Kit Espelho Opcional.

Optional Mirror Kit Assembly.  
Montaje de Kit Espejo Opcional.

## Espelho Opcional.

Optional Mirror  
Espejo Opcional.



## NÃO UTILIZAR PARAFUSADEIRA

DO NOT USE A SCREWDRIVER  
No utilice un destornillador

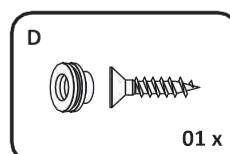
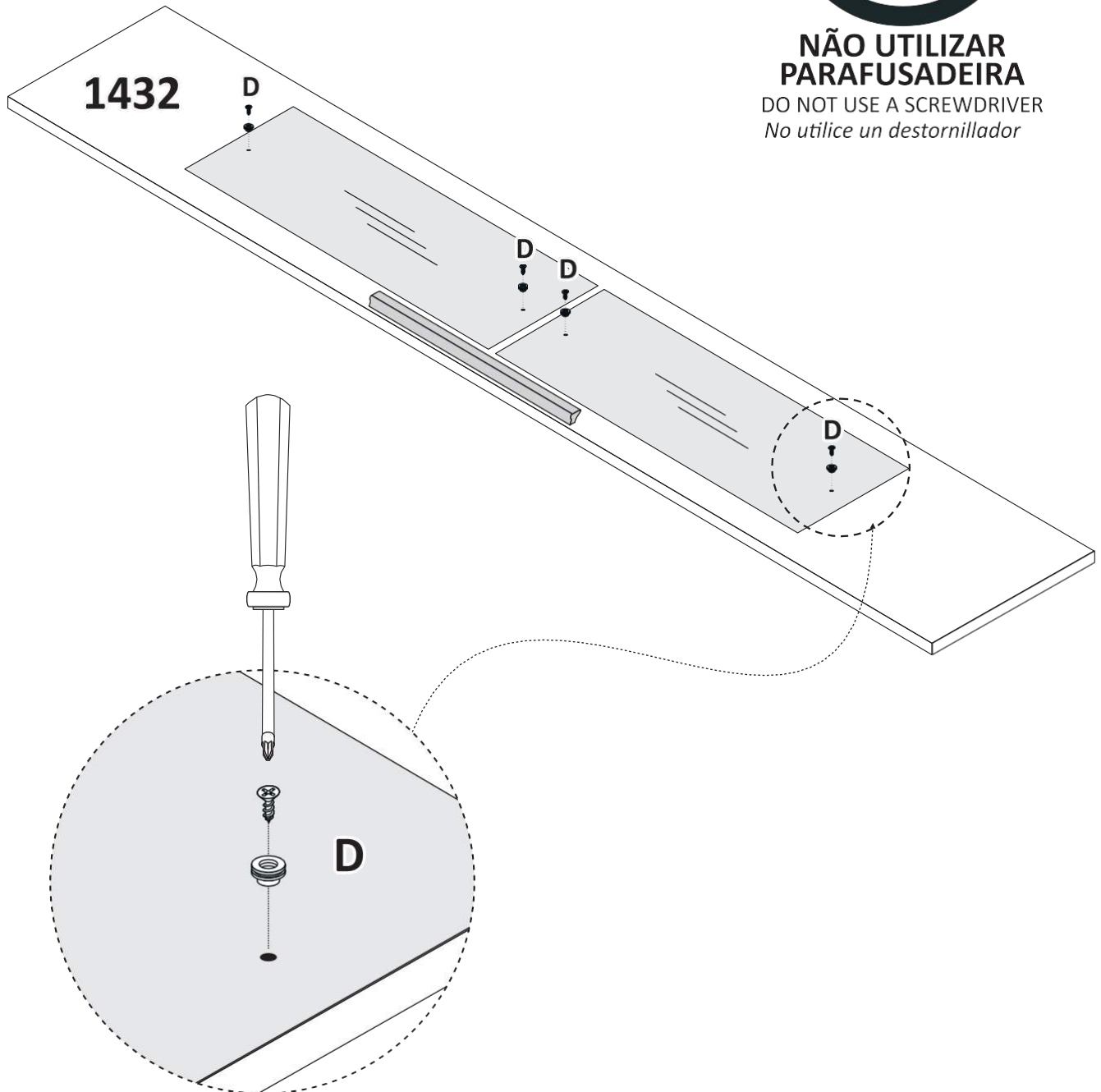

# Montagem Porta Reflecta Esquerda.

Left Reflecta Door Assembly.

Montaje de la Puerta Reflecta Izquierda.

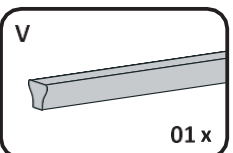
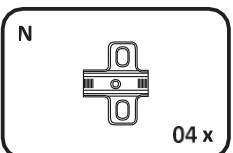
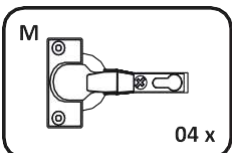
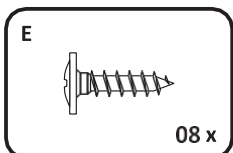
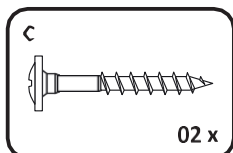
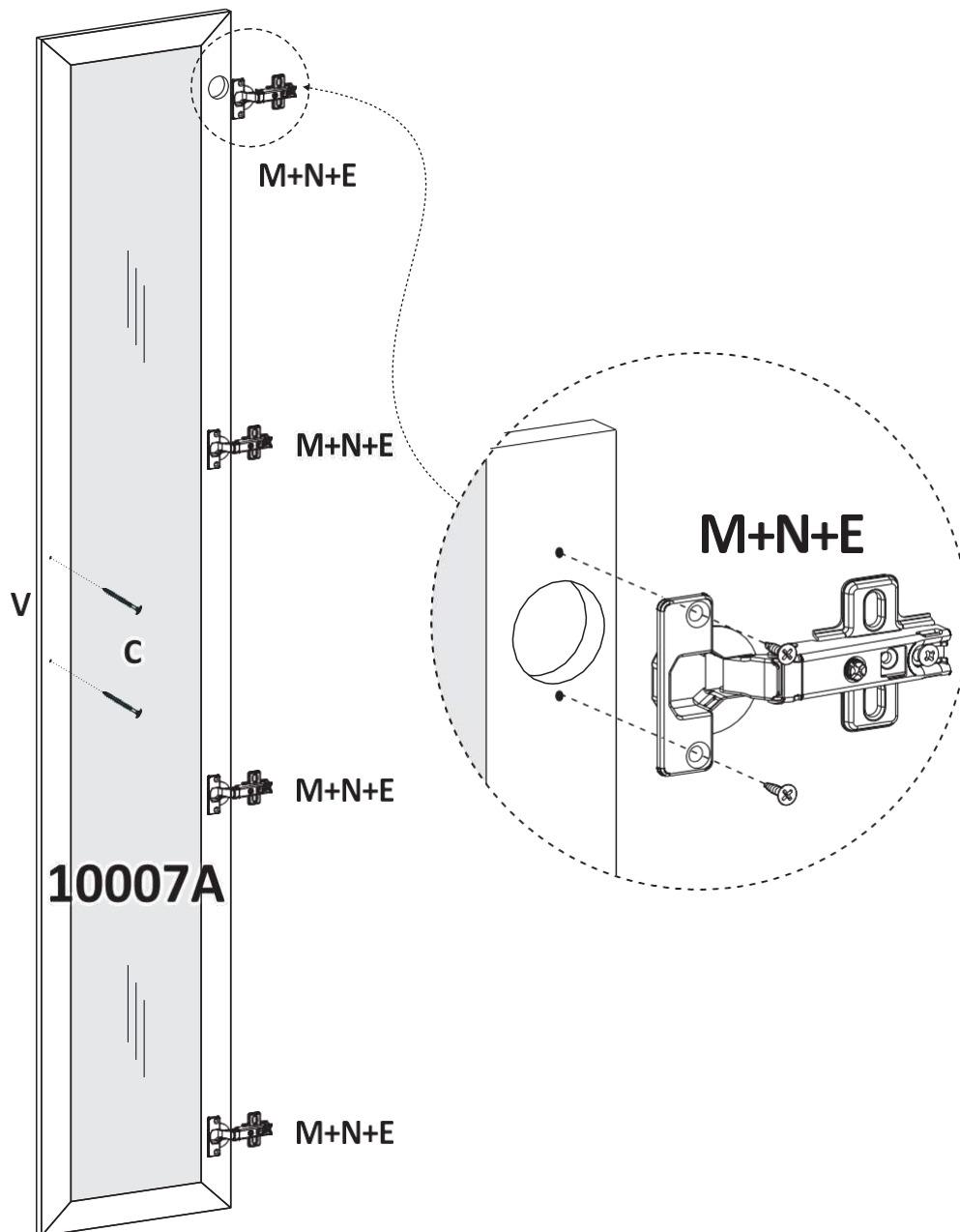

# Montagem Porta Reflecta Direita.

Right Reflecta Door Assembly.

Montaje de la Puerta Reflecta Derecha.

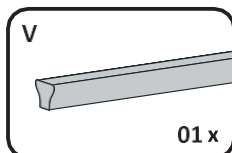
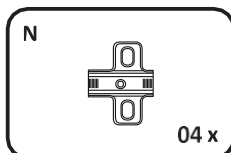
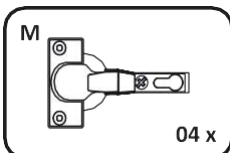
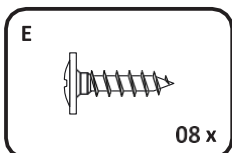
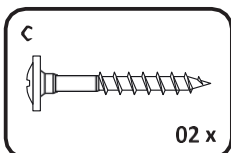
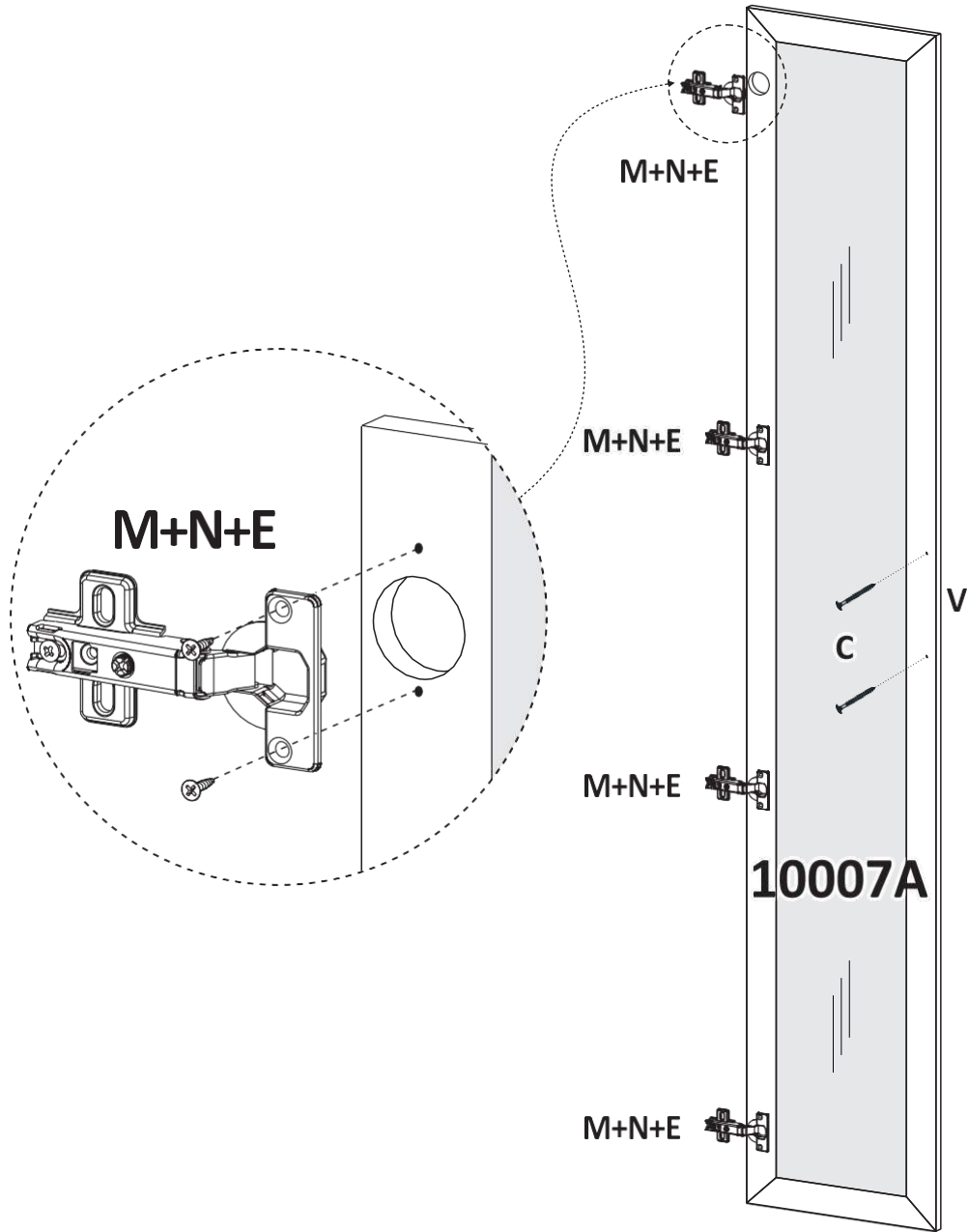

# Montagem do Ripado.

Assembly Slatted.

Montaje de Ranurado.



**NÃO UTILIZAR  
PARAFUSADEIRA**  
DO NOT USE A SCREWDRIVER  
No utilice un destornillador

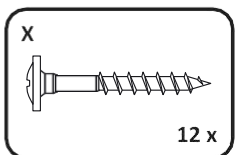
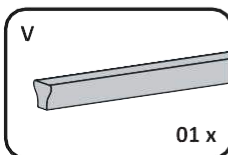
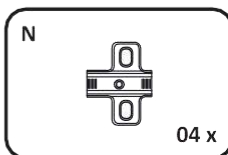
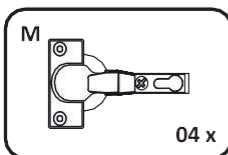
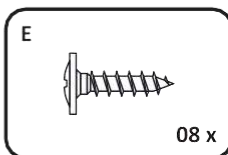
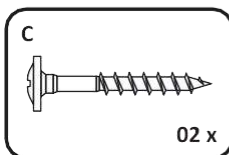
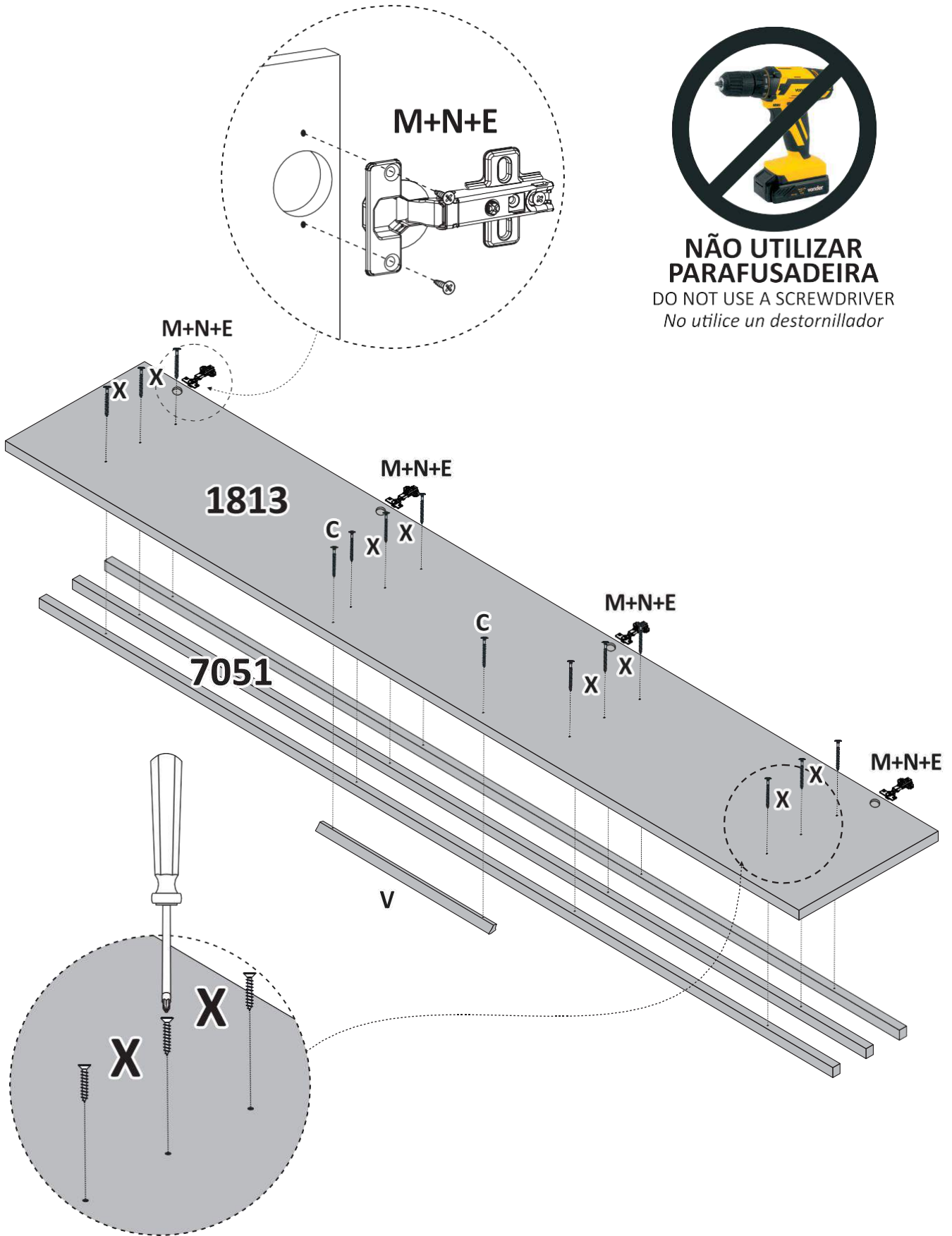

# Coloção das Portas.

Door Placement.

Colocación de Puertas.

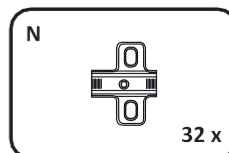
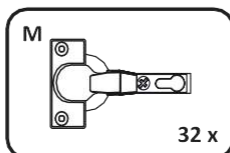
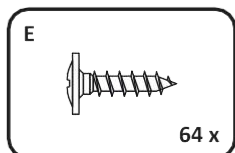
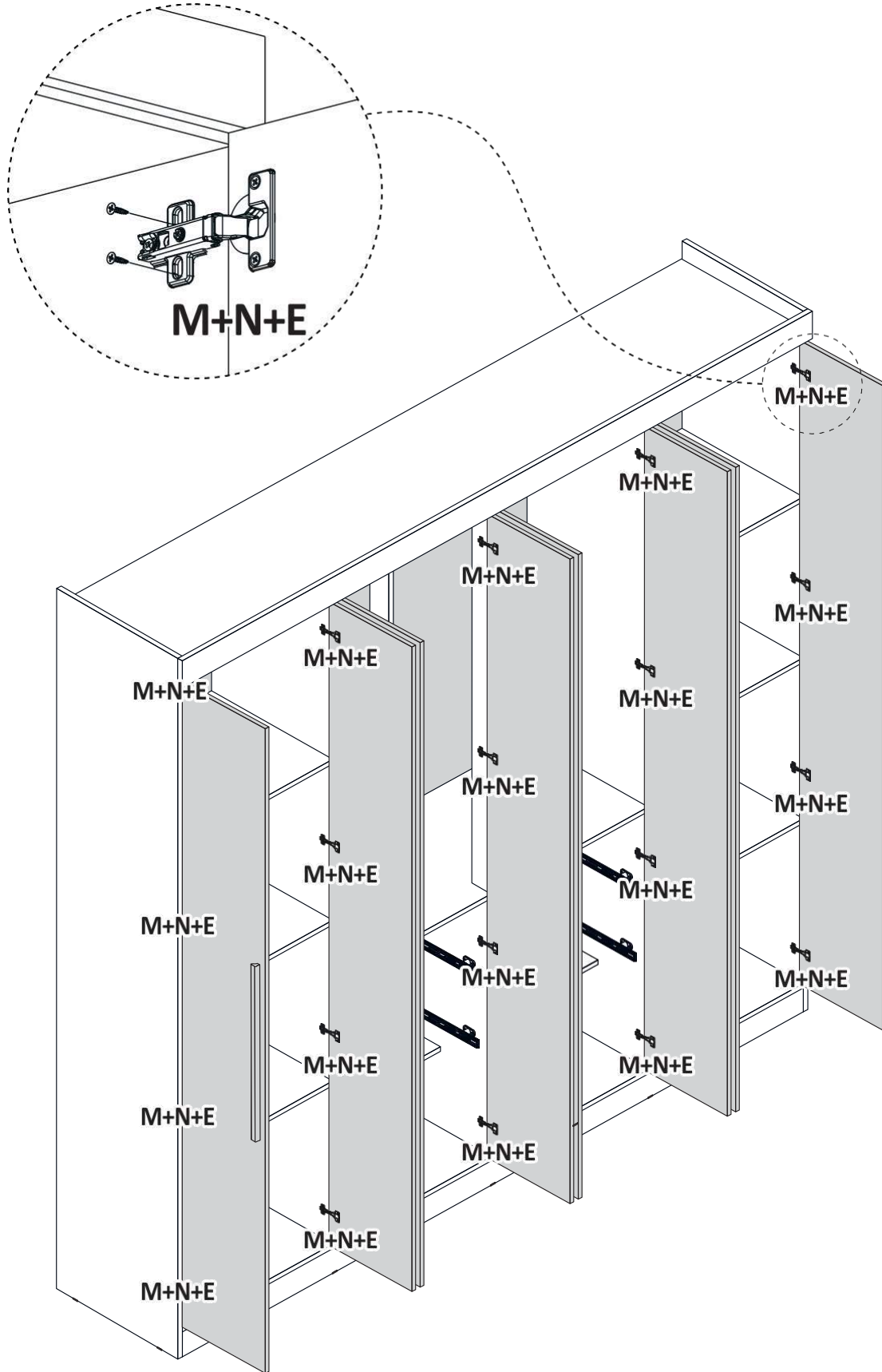

# Montagem das Gavetas.

Assembling the Drawers.  
Montaje de Cajones.

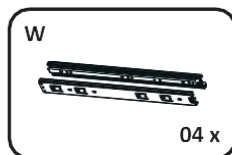
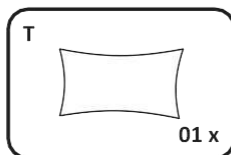
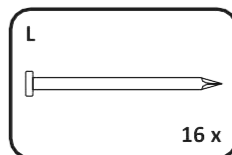
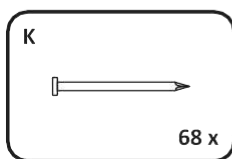
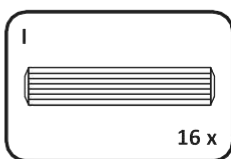
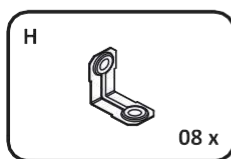
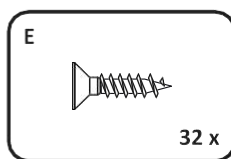
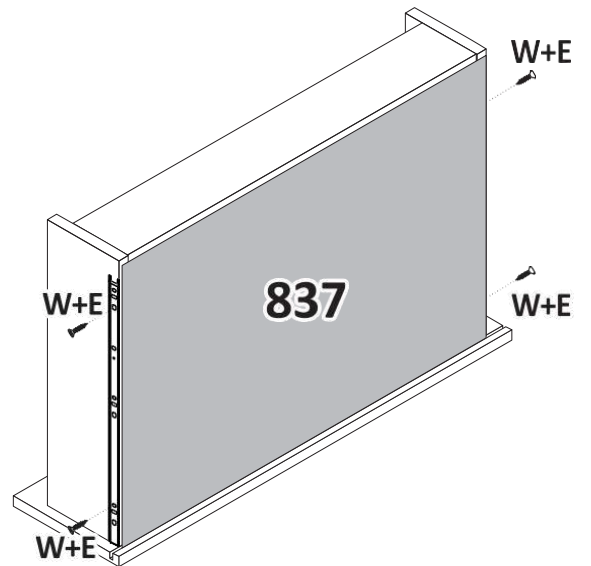
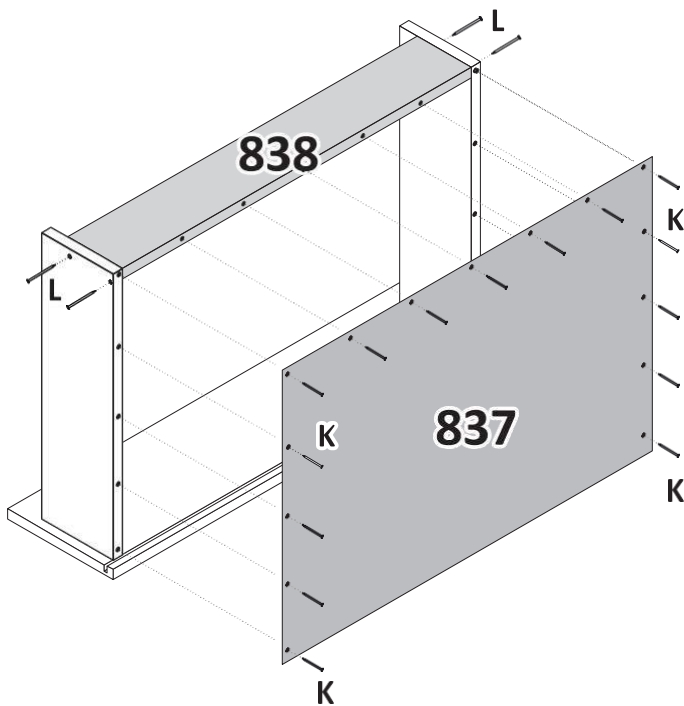
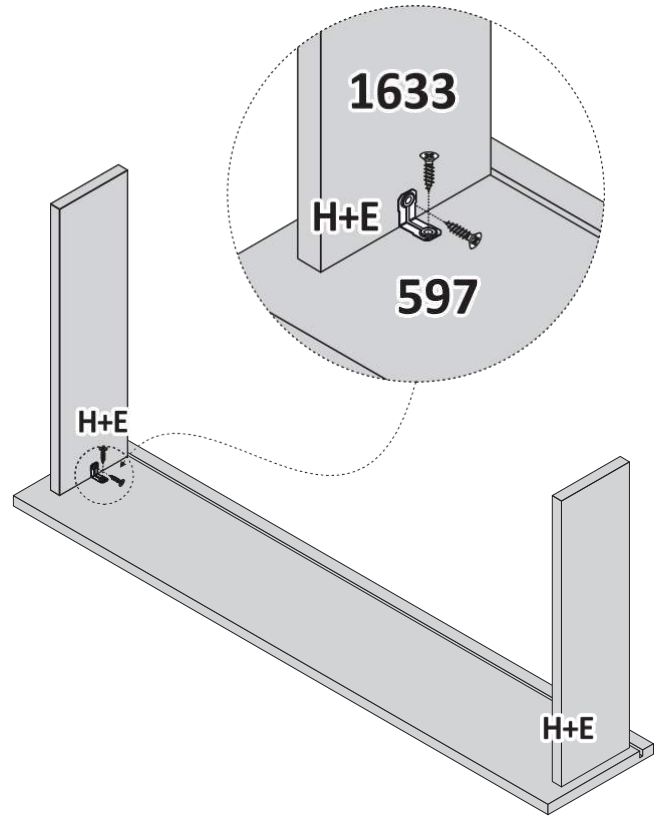
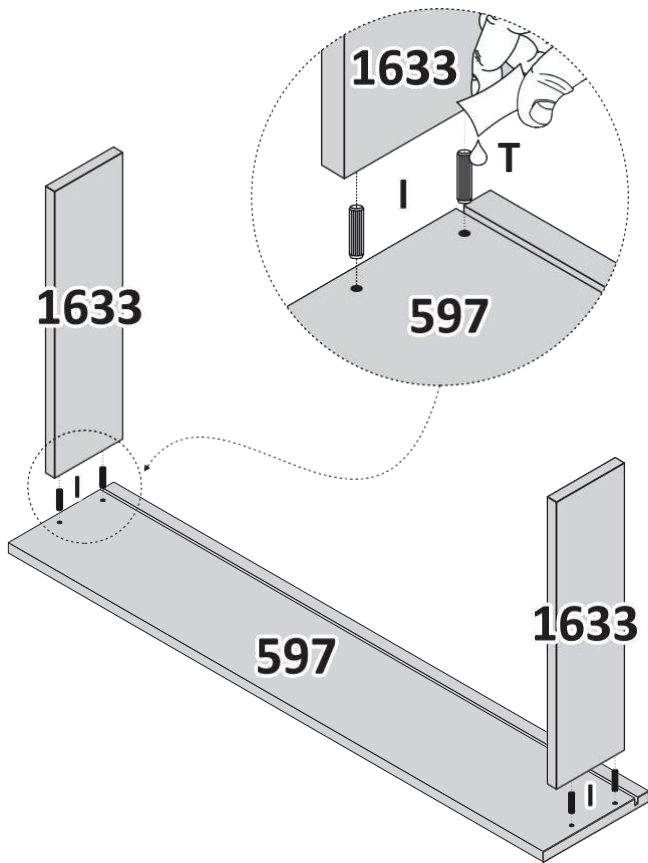

**Produto montado.**

Asembled product.  
Producto ensamblado.

051-988877667

**RP 60800**

ESPELHO OPCIONAL  
OPTIONAL MIRROR  
ESPEJO OPCIONAL

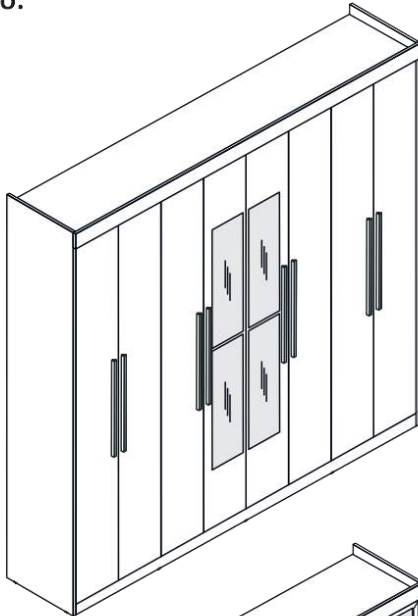

**RP 68500**

PORTA REFLECTA  
REFLECTA DORR  
PUERTA REFLECTA

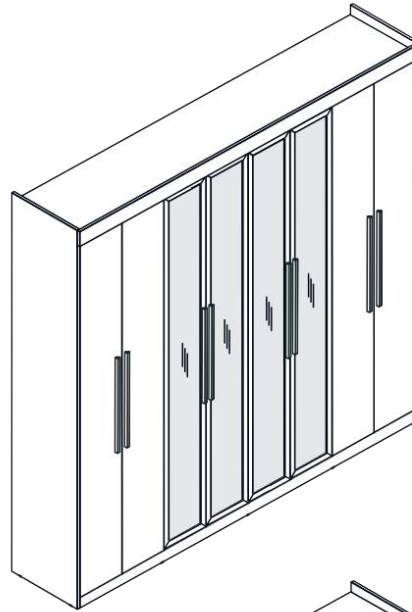

**RP 68500**

PORTA REFLECTA  
REFLECTA DORR  
PUERTA REFLECTA

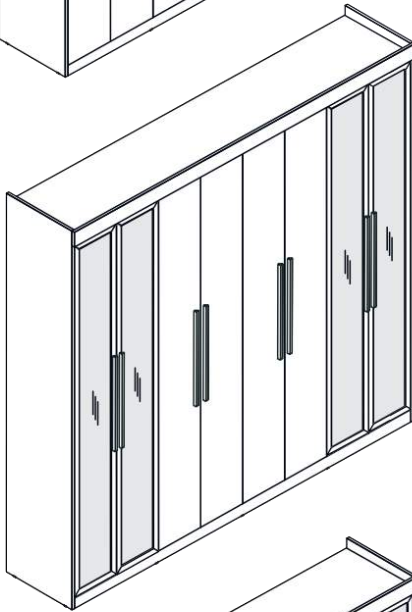

**RP 45850**

PORTA RIPADA  
SLATTED DOOR  
PUERTA RANURADA

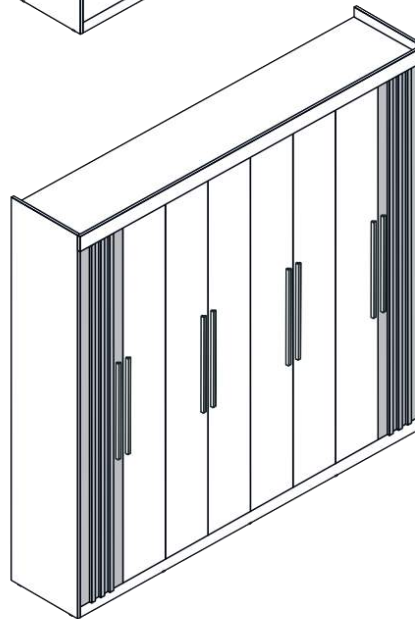

**RP 70300**

PORTA REFLECTA  
REFLECTA DORR  
PUERTA REFLECTA

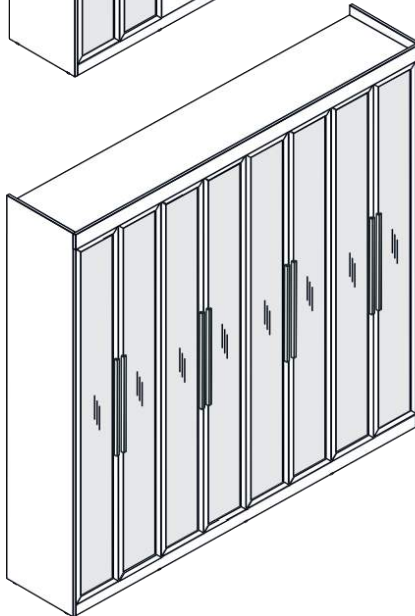

**Doripel**  
móveis

Moveis.Doripel

DoripelMoveis

54 3358.6500

Av. Julio Vanzin, 1600 - Área Industrial Lagoa Vermelha - RS - Brasil

comercial@doripel.com.br | assistencia@doripel.com.br

doripel.com.br