

**Sr Montador:**  
- Confira todas as peças das embalagens com a lista de peças contida neste manual;  
- Separe os acessórios, confira as medidas dos parafusos com a escala;  
- Siga todas as orientações deste manual de montagem para ter o direito à garantia do produto;  
- Indicamos que a montagem seja feita por um profissional mediante a leitura e orientação desse manual de montagem

**Mr. Assembler:**  
- Check all parts of the packages with the parts list contained in this manual;  
- Separate the accessories, check the measurements of the screws with the scale above;  
- Follow all the instructions in this assembly manual to be entitled to product warranty;  
- We indicate the assembly by a professional according to the reading and orientation contained in the assembly scheme

**Sr Montador:**  
- Verifique que todas las piezas de la lista están incluidas en el embalaje;  
- Separe los accesorios, confirme las medidas de los tornillos de acuerdo con la escala;  
- Siga todas las instrucciones de este manual de armado para tener derecho a la garantía del producto;  
- Indicamos el armado por un profesional según la lectura y orientación contenida en el esquema de armado

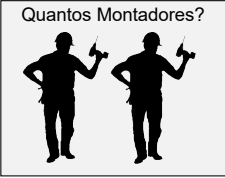

Código da Peça  
Piece Code  
Código de la Pieza  
00000 0 00 -00  
Padrões de Cor  
Color default  
Padrón de Color



Tabela de Cor	
BRANCO UV	5
FREIJO UV/RIPADO/OFF ACETIN	145
FREIJO UV/OFF ACETIN	143

**Guarde a etiqueta colada na embalagem do produto lá estão informações importantes do seu produto, caso necessite de assistência técnica você precisa informar o número do lote contido na etiqueta.**

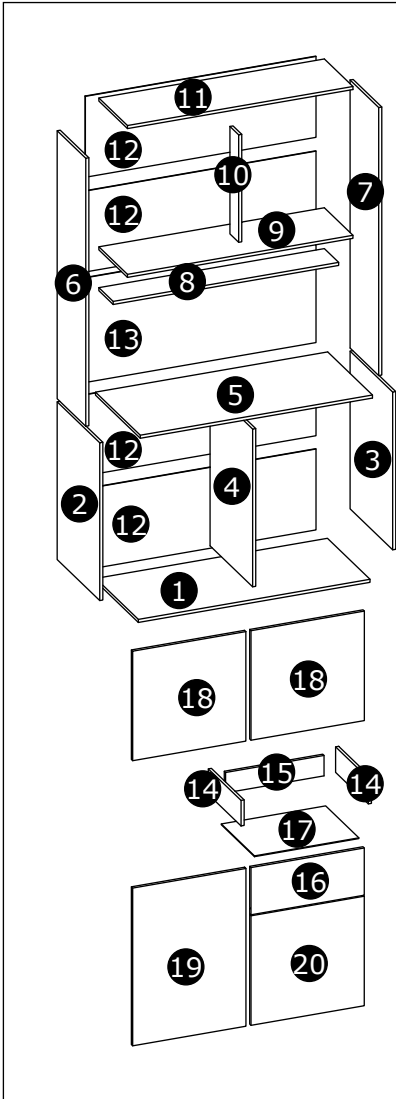

CÓD	SEQ	DESCRIÇÃO	DESCRIPTION	DESCRIPCIÓN	QTD	COMP	LARG	ESP	MAT-PRIMA
15031001	1	BASE INFERIOR	BTM BASE	BS INF	1	902	390	12	MDP
15031006	2	LATERAL ESQUERDA INFERIOR	BTM LFT SD	LD IZQ INF	1	618	390	12	MDP
15031007	3	LATERAL DIREITA INFERIOR	BTM RGT SD	LD DER INF	1	618	390	12	MDP
15031011	4	DIVISÓRIA INFERIOR	BTM DIV	DIV INF	1	618	390	12	MDP
15031002	5	TAMPO	TOP	TPA	1	902	410	12	MDP
15031008	6	LATERAL SUPERIOR ESQUERDA	TOP LFT SD	LD IZQ SUP	1	1044	262	12	MDP
15031009	7	LATERAL SUPERIOR DIREITA	TOP RGT SD	LD DER SUP	1	1044	262	12	MDP
15031003	8	PRATELEIRA RECUADA	REC SHELF	EST RECD	1	876	131	12	MDP
15031004	9	BASE SUPERIOR	TOP BASE	BS SUP	1	876	262	12	MDP
15031010	10	BATENTE	DOOR FRM	MRCO PTA	1	421	80	12	MDP
15031005	11	CHAPÉU	CAP	SOM	1	876	262	12	MDP
15031012	12	FUNDO SUPERIOR/INFERIOR	TOP/BTM BK	RSP SUP/INF	4	896	317	3	HDF
15031013	13	FUNDO CENTRAL	CTR BK	RSP CTR	1	896	410	3	HDF
U0000002	14	LATERAL DE GAVETA	DRWR SD	LAT CJN	2	300	100	12	MDP
15031020	15	CONTRAFUNDO GAVETA	BK SPRT DRWR	SPR PST CJN	1	383	80	12	MDP
15031017	16	FRENTE DE GAVETA	FRNT CHNL 21	FR CJN CNL 21	1	185	440	15	MDP
15031014	17	FUNDO GAVETA	DRWR BK	RSP CJN	1	406	304	3	HDF
15031015	18	PORTA SUPERIOR	TOP DOOR	PTA SUP	2	429	440	15	MDP
15031016	19	PORTA INFERIOR MAIOR	LRG BTM DOOR	PTA INF MJR	1	618	440	15	MDP
15031018	20	PORTA INFERIOR MENOR	SML BTM DOOR	PTA INF MNR	1	429	440	15	MDP

Aspecto Final - Imagens ilustrativa  
Final Aspect - Illustrative images  
Aspecto final - Imágenes ilustrativas

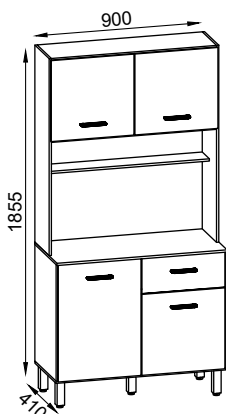

Medida Final /Final Measure

Medidas Internas  
Internal Measures

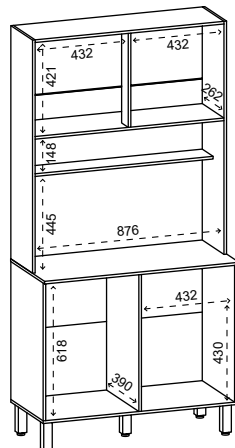

Desenho - ELM - Edição - A4 - Data - 02/09/2025

Pesos Suportados  
Supported Weights  
Pesos admitidos

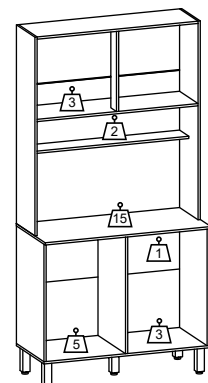

Os pesos indicados devem ser distribuídos em toda a peça  
The weights indicated should be distributed throughout the piece  
Los pesos indicados deben distribuirse por toda la pieza

### Utilizar a régua para medir os componentes











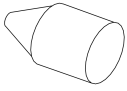





Utilice la medida abajo para medir los componentes  
Use the ruler in order to measure the following components

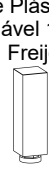

## Passos da Montagem

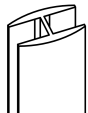
### Pasos del montaje / Mounting Steps

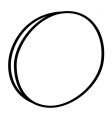
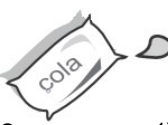
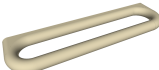

Todos os parafusos da tabela são do tipo Philips  
All screws in the table are Philips type.  
Todos los tornillos de la mesa son tipo Philips.

<b>Parafuso Chato</b> 4,0x40mm  A 28X	<b>Giz Corretivo</b> BCO/Frejijó  B 1X	<b>Cavilha Madeira</b> 6,0x30mm  C 18X	<b>Parafuso Chato</b> 3,5x12mm  D 52X	<b>Parafuso Chato</b> 4,0x25mm  E 10X	<b>Parafuso Chato</b> 5,0x50mm  F 5X	<b>Cantoneira Metálica</b> 16x16mm  G 12X
<b>Junção para Fundo</b> Metal 12x12mm  H 14X	<b>Prego</b> 10x10mm  I 72X	<b>Calço Metal</b> 5mm  J 8X	<b>Dobradiça Metal</b> 26mm  K 8X	<b>Pé Plástico</b> Regulável 170mm Freijó  L 5X	<b>Corrediça Metálica</b> 300mm  M 1X	<b>Perfil H. 878mm</b> BCO/Frejijó Plástico  N 2X
<b>Logotipo</b> 35x15mm  O 1X	<b>Tapa Furo Adesivo</b> BCO/Frejijó  P 34X	<b>Sachet Cola PVA</b>  Q 1X	<b>Puxador Plástico</b> Level Ouro Fosco 135x35x9mm  R 5X	<b>Parafuso com Porca</b> M4x20mm  S 16X		

### Passo 1

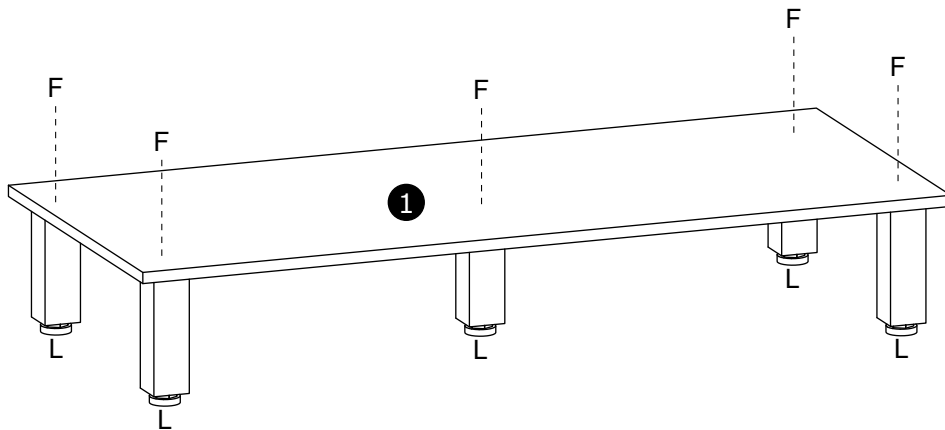
#### Paso/Step





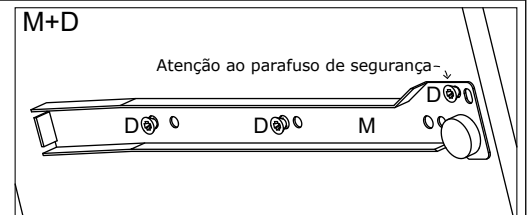
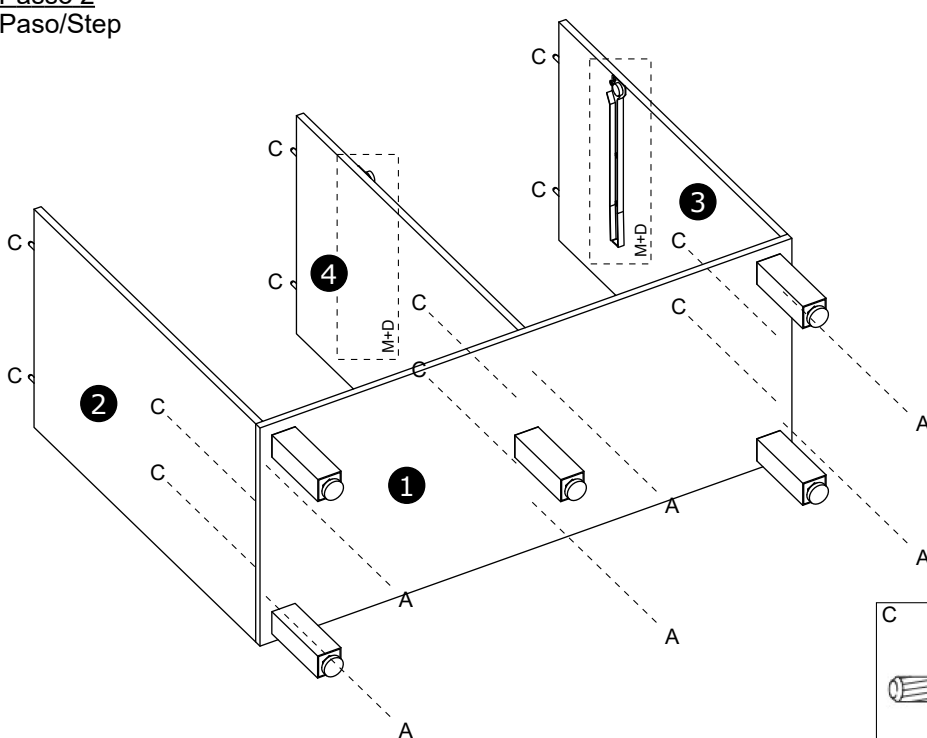

<b>F Parafuso Chato</b> 5,0x50mm  5X
<b>L Pé Plástico</b> Regulável 170mm Freijó  5X

### Passo 2

#### Paso/Step



<b>C Cavilha</b> Madeira 6,0x30mm  12X	<b>A Parafuso Chato</b> 4,0x40mm  6X	<b>M Corrediça</b> Metálica 300mm  1X	<b>D Parafuso Chato</b> 3,5x12mm  6X
--	--	--	--

**Passo 3**  
Paso/Step

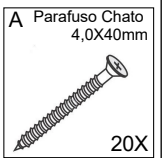
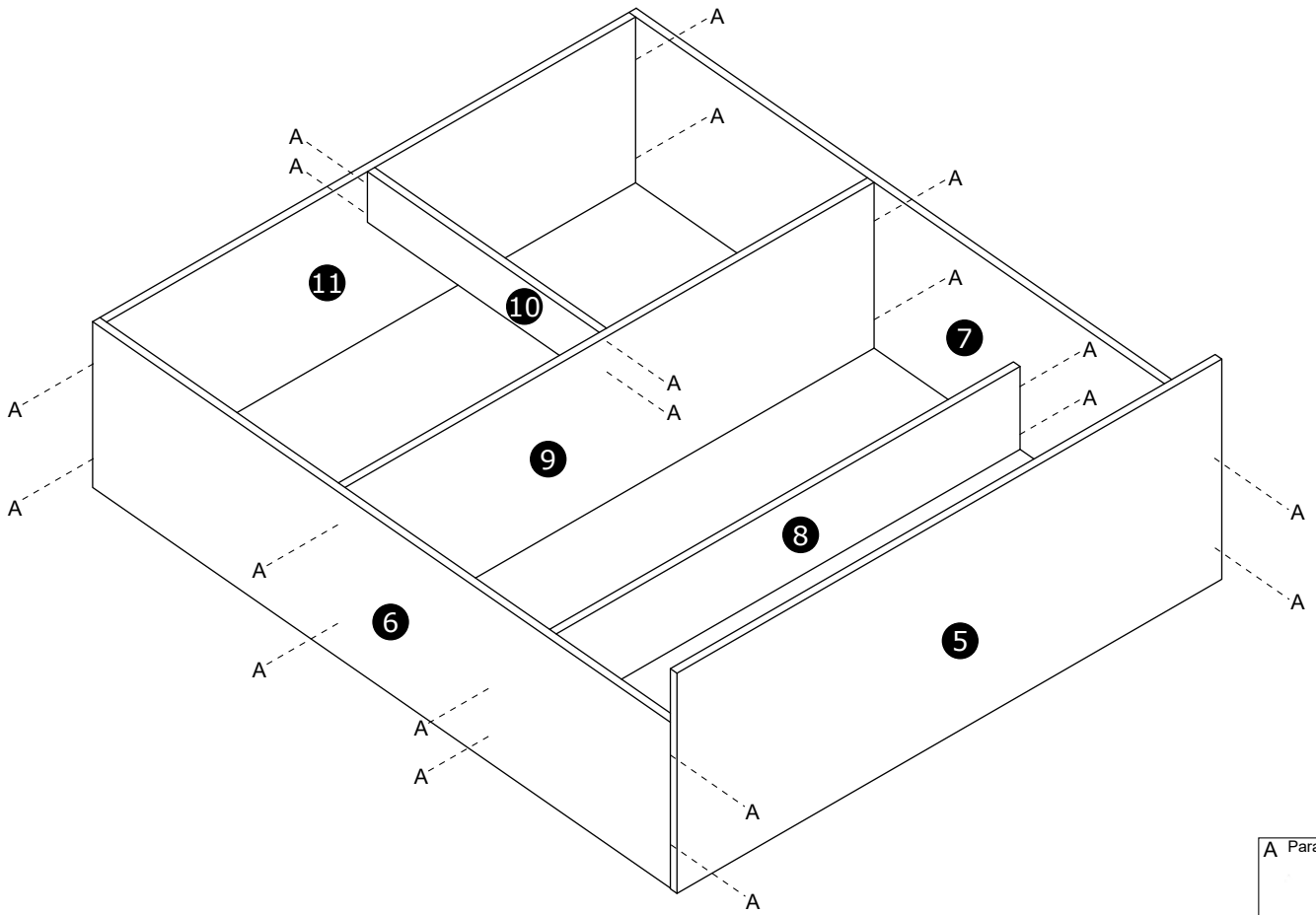

**Passo 4**  
Paso/Step

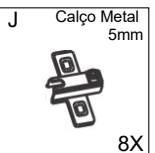
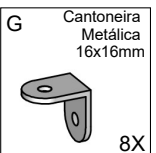
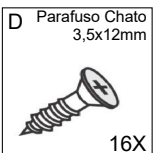
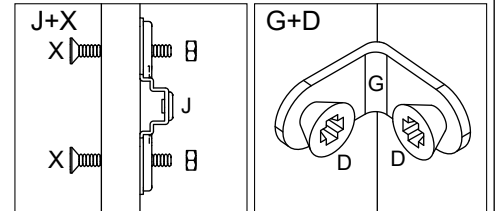
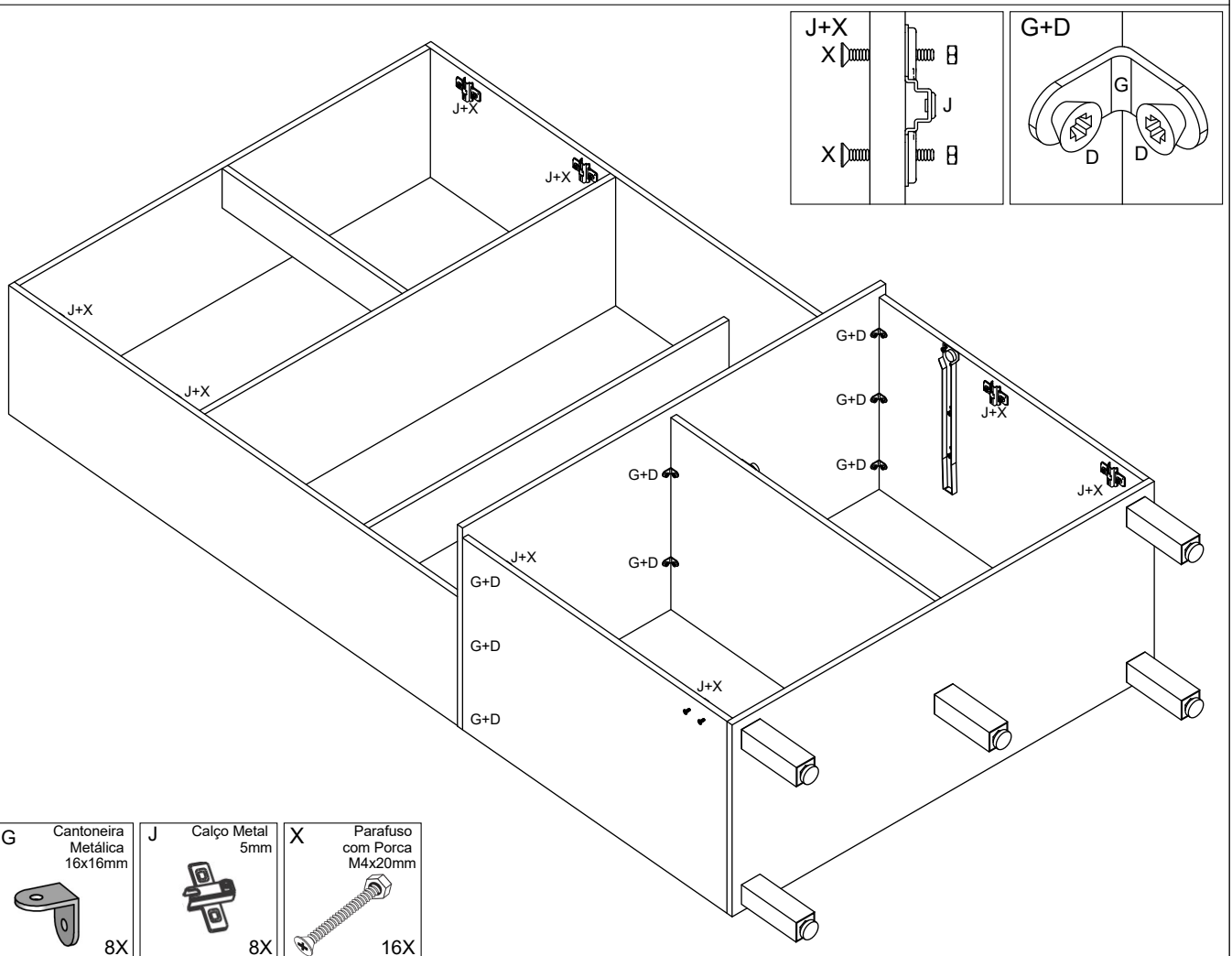

**Passo 5**  
Paso/Step

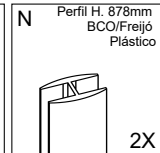
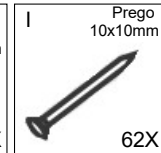
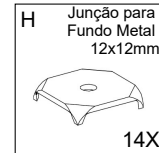
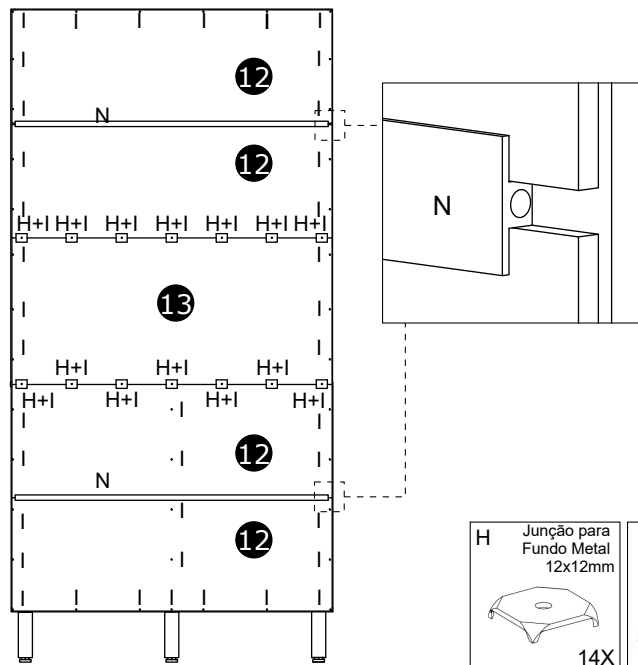

**Passo 6**  
Paso/Step

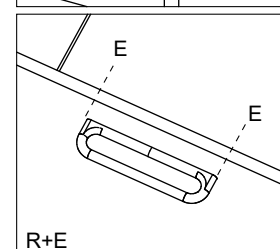
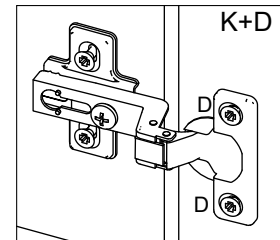
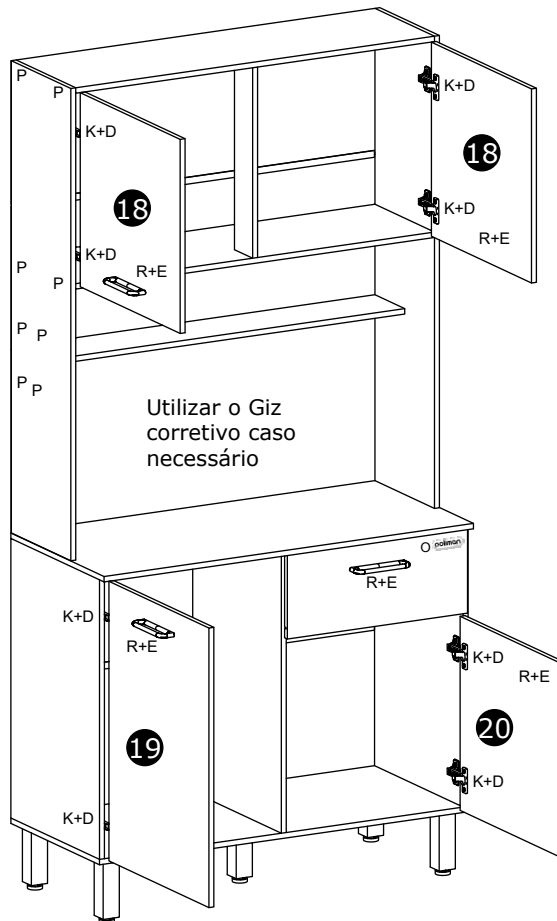
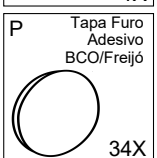
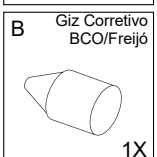
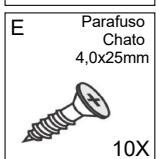
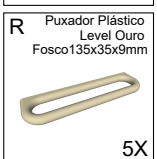
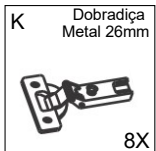
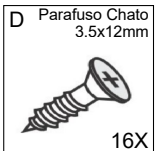
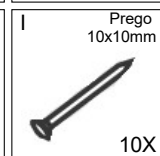
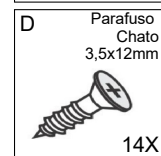
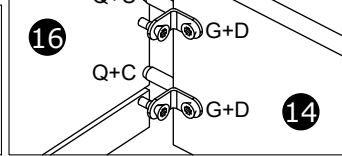
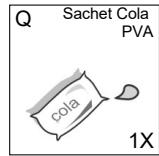
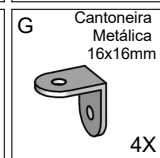
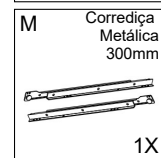
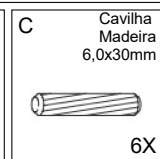
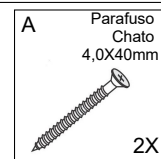
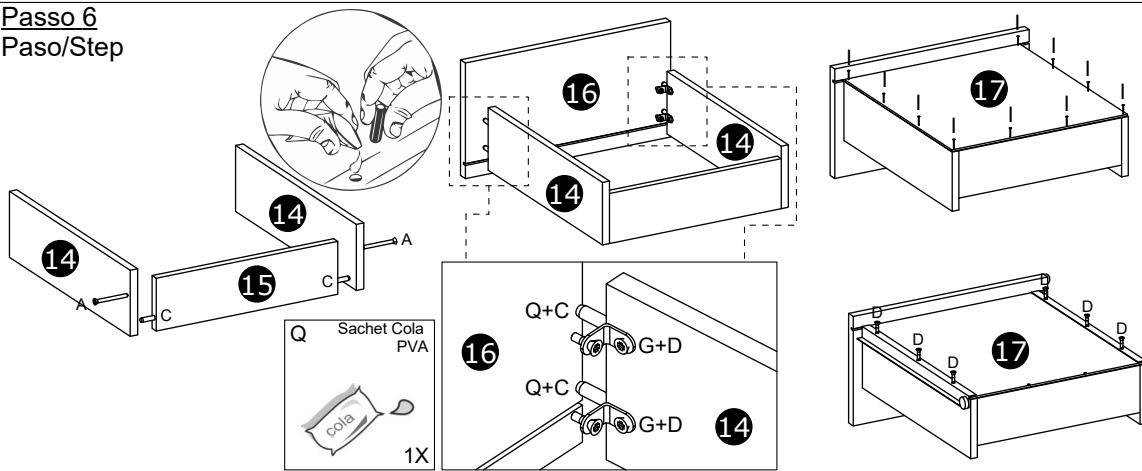

**Termo de Garantia / Renuncia de Garantía / Warranty Term**



sac@poliaman.ind.br



Data de Emissão  
Fecha de Expedicion  
Date of Issue \_\_\_\_\_

Cliente / Client \_\_\_\_\_

Vendedor /Loja  
Vendedor/ Tienda  
Seller/ Store

**Dicas de conservação / Dicas para Conservación / Conservation Tips**

Para limpar ou tirar manchas, utilize uma flanela umedecida em solução de água e álcool, na mesma proporção *Evite exposição ao sol.	Para limpiar o retirar manchas, utilice un paño humedecido en una solución de agua y alcohol, en la misma proporción. *Evite la exposición directa al sol..	To clean or remove stains, use a flannel moistened with water and alcohol solution in the same proportion. *Avoid sun exposure.
---	--	--

Poliman Indústria e Comércio de Móveis Ltda., garante este produto (peças e mão de obra, por defeitos de fabricação), pelo prazo de noventa dias a partir da data de emissão da nota fiscal de venda do produto ao consumidor.

Poliman Indústria e Comércio de Móveis Ltda. Garantiza este producto (piezas y mano de obra debido a defectos de fabricación), por un período de noventa días a partir de la fecha de emisión de la factura de venta del producto al consumidor.

Poliman Indústria e Comércio de Móveis Ltda. Warrants this product (parts and labor due to manufacturing defects), for a period of ninety days from the date of issuance of the sales invoice of the product to the consumer.

**Termo de Garantia Contratual/ Documento de Garantía Contractual/ Contractual Warranty Term**

- 1) Apresentar este certificado de garantia acompanhado do recibo de compra do local de aquisição do produto.
- 1) Presente este certificado de garantía junto con el recibo de compra del establecimiento.
- 1) Submit this certificate of guarantee accompanied by the purchase receipt of the place of purchase of the product.
- 2) Esta garantia perderá sua validade mesmo dentro do prazo acima estipulado se:
- 2) Esta garantía perderá su validez, incluso dentro del plazo arriba estipulado en los siguientes casos:
- 2) This warranty will lose its validity even within the above time limit if:
  - O produto apresentar danos por mau trato, acidente, uso diferente do indicado ou uso em condições ambientais deficientes (contato direto com água, fogo, etc.);
  - Si el producto está dañado por abuso, accidente, mal uso, uso diferente al indicado o utilizado en condiciones ambientales deficientes (contacto directo con agua, fuego, etc.);
  - The product presents damages due to ill-treatment, accident, use other than the indicated one or use in terms of environment deficient (direct contact with water, fire, etc.);
  - Os vidros e espelhos quebrarem ou trincarem após a entrega e montagem dos produtos;
  - Cuando los vidrios y espejos se rompan se rallen después de la entrega y el montaje de los productos;
  - Glasses and mirrors break after delivery and assembly of the products;
  - Quando o produto não for montado por profissionais devidamente treinados pelo revendedor;
  - Cuando el producto no sea instalado por profesionales debidamente entrenados por el concesionario;
  - When the products is not assembled by professionals properly trained by the dealer
  - Dobradiças, corrediças e puxadores somente terão sua garantia quando apresentarem defeitos de fabricação.
  - Bisagras, correderas y tiradores sólo tendrán garantía cuando presenten defectos de fabricación.
  - Hinges, slides and handles are only warranted when they have manufacturing defects
  - O consumidor exceder o limite de peso estipulado para cada parte do produto, conforme especificado no Manual de Montagem.
  - Cuando el consumidor supere el límite de peso estipulado para cada uno de los productos, tal como se especifica en el Manual de Instalación.
  - The consumer exceeds the stipulated weight limit for each part of the product as specified in the Assembly Manual.
- 3) Todo e qualquer produto com avarias deverá ser feito vistoria por parte do técnico autorizado pelo revendedor e indústria. Em hipótese alguma será realizada a troca total do produto.
- 3) Cualquier producto con daños debe ser inspeccionado por un técnico autorizado por el distribuidor y la fábrica. En ningún caso se llevará a cabo el cambio completo del producto.
- 3) Any product with faults should be inspected by the dealer authorized technician and industry. Under no circumstances will the total exchange of the product be carried out

**Código Defesa do Consumidor / Código de Defensa del Consumidor / Consumer Defense Code**

<p align="center"><b>ATENDIMENTO DE PEÇAS</b></p> <p>Art. 18. Os fornecedores de produtos de consumo duráveis ou não duráveis respondem solidariamente pelos vícios de qualidade ou quantidade que os tornem impróprios ou inadequados ao consumo a que se destinam ou lhes diminuam o valor, assim como por aqueles decorrentes da disparidade, com a indicações constantes do recipiente, da embalagem, rotulagem ou mensagem publicitária, respeitadas as variações decorrentes de sua natureza, podendo o consumidor exigir a substituição das partes viciadas.</p> <p>§ 1º Não sendo o vício sanado no prazo máximo de trinta dias, pode o consumidor exigir, alternativamente e à sua escolha:</p> <p>I - a substituição do produto por outro da mesma espécie, em perfeitas condições de uso; II - a restituição imediata da quantia paga, monetariamente atualizada, sem prejuízo de eventuais perdas e danos; III - o abatimento proporcional do preço.</p>	<p align="center"><b>REPOSICIÓN DE PIEZAS</b></p> <p>ART. 18. Los proveedores de productos de consumo duraderos o no duraderos responden, solidariamente, de los vicios de calidad o cantidad que los tornen improprios o inadecuados para el consumo al que se destinan o disminuyan su valor, así como de aquellos que sean resultado de la disparidad con las indicaciones que constan en el recipiente, embalaje, rotulado o mensaje publicitario, respetando las variaciones derivadas de la naturaleza de producto, pudiendo el consumidor exigir la sustitución de las partes viciadas.</p> <p>1º No siendo el vicio subsanado en el plazo máximo de 30 días, el consumidor puede exigir alternativamente y en su elección:</p> <p>I - La sustitución del producto por otro de la misma especie en perfectas condiciones de uso; II - La restitución inmediata del importe pagado, con actualización monetaria, sin perjuicio de las eventuales pérdidas y daños; III - La reducción proporcional del precio..</p>	<p align="center"><b>PARTS ASSISTANCE</b></p> <p>Art.18 - Suppliers of durable or non-durable consumer products are jointly and severally liable for quality or quantity which renders them unfit or unsuitable for the intended use or which diminish their value, as well as those arising from the disparity, the particulars in the container, the packaging, the labeling or the advertising message, subject to variations due to their nature, and the consumer may require the replacement of the defective parts.</p> <p>§ 1° - If the defect is not remedied within a maximum of thirty days, the consumer may, alternatively and at his choice, request: I - the replacement of the product with another of the same species, in perfect conditions of use; II - the immediate return of amount paid, monetarily updated, without prejudice to any losses and damages; III - the proportional reduction of the price.</p>
--	---	--

<p align="center"><b>GARANTIA LEGAL</b></p> <p>Art. 26. O direito de reclamar pelos vícios aparentes ou de fácil constatação caduca em:</p> <p>II - noventa dias, tratando-se de fornecimento de serviço e de produtos duráveis.</p>	<p align="center"><b>GARANTIA LEGAL</b></p> <p>Art. 26. El derecho de reclamar por los vicios aparentes o de fácil constatación caduca en:</p> <p>II - Noventa días, tratando-se de suministros de servicios y productos duraderos.</p>	<p align="center"><b>LEGAL GUARANTEE</b></p> <p>Art. 26. The right to complain about apparent or easily found defects expires in:</p> <p>II - ninety days, in the case of service provision and durable products.</p>
--	---	---