

Tempo de Montagem
Assembly time
Tiempo de ensamblaje



1 hora.
1 hour.

CORES/COLORES/COLORS

763 - CINAMOMO MEL - PEROLA METALIZADO.

765 - PEROLA METALIZADO - CINAMOMO MEL

766 - GRIGIO FOSCO - CINAMOMO MEL

FICHA TÉCNICA / HOJA TECNICA / TECHNICAL SHEET





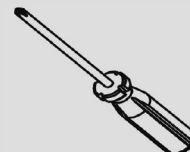
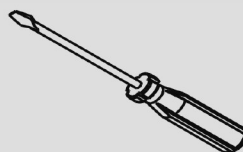
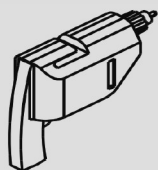





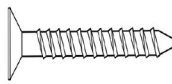
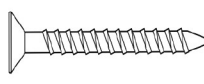

Nº	DESCRIÇÃO	DESCRIPCIÓN	DESCRIPTION	MAT. PRIMA	MEDIDA (MM) MEASUREMENTS	QTD
01	FUNDO	FONDO	BOTTOM	HDF MÖB PRINT	1825X360X03	1
02	FUNDO SUPERIOR	FONDO SUPERIOR	UPPER BACKGROUND	HDF MÖB PRINT	1825X122X03	1
21	TAMPO	TAPA	COVER	MDP MÖB PRINT	1830X360X25	1
22	LATERAL DIREITA	LADO DERECHO	RIGHT SIDE	MDP MÖB PRINT	450X358X15	1
23	BASE	BASE	BASE	MDP MÖB PRINT	1830X360X15	1
24	LATERAL ESQUERDA	LADO IZQUIERDO	LEFT SIDE	MDP MÖB PRINT	450X358X15	1
26	PORTA	PUERTA	DOOR	MDP MÖB PRINT	900X442X24	1
27	DIVISÃO	DIVISIÓN	DIVISIÓN	MDP MÖB PRINT	450X312X12	1
28	PRATELEIRA	ESTANTE	SHELF	MDP MÖB PRINT	894X310X15	1
30	PÉ	PATA	FOOT	MDP MÖB PRINT	350X65X25	4
31	RODAPÉ FRONTAL/TRASEIRA	ZÓCALO FRONTAL/LATERAL	FRONT / SIDE WALLBOARD	MDP MÖB PRINT	1830X65X15	2
34	RODAPÉ LATERAL	ZÓCALO LATERAL	SIDE PANEL	MDP MÖB PRINT	295X65X15	3
36	PÉ CENTRAL	PATA CENTRAL	CENTER FOOT	MDP MÖB PRINT	198X65X25	1

FERRAMENTAS NECESSÁRIAS | Herramientas necesarias | Required tools



Não fornecidas - No provisto - Not provided

DESCRIÇÃO DE ACESSÓRIOS | DESCRIPCIÓN DEL ACCESORIO | ACCESSORY DESCRIPTION





CÓD	DESCRIÇÃO	DESCRIPCIÓN DESCRIPTION	QTD	DESENHO Diseño Design
A	CAVILHA 6X30mm	BOLSILLO DE MADERA WOODEN POCKET	06	
B	PARAFUSO 3,5X12mm	TORNILLO 3,5*12 SCREW 3,5*12	68	
C	PARAFUSO 4,0X35mm	TORNILLO 4,0*35 SCREW 4,0*35	18	
D	PARAFUSO 35X4,0mm	TORNILLO 3,5*40 SCREW 3,5*40	10	
E	CHAPINHA DUPLA 42X42 "L"	4 HOLE CORNER ESQUINA DE 4 AGUREJOS	14	
F	PERFIL H 1796mm	PERFIL H 1796mm PROFILE H 1796mm	01	
G	PERFIL GUIA ROLDANA 1796mm	GUÍA DE POLEA DE PERFIL 1796mm PROFILE PULLEY GUIDE 1796mm	01	
H	TAMPA DA CASTANHA 18mm 1ºcor	PARTE SUPERIOR DEL TORNILLO SCREW TOP	12	
I	PREGO 8X8	NAIL 8 X 8 CLAVO 8 X 8	50	
J	PREGO 13X15	NAIL 13 X 15 CLAVO 13 X 15	10	
K	SAPATA DESLIZADORA	ZAPATA DESLIZANTE ZAMAC CONNER	05	
L	CANTONEIRA ZAMAC	CANTONEIRA ZAMAC ZAMAC CONNER	06	
R	KIT ROLDANA CELSUS 1 PORTA	KIT ROLDANA 1 PUERTA KIT ROLLER 1 DOOR	01	

1005134 - BANCADA AURORA

MANUAL DE MONTAGEM - MANUAL DE MONTAJE - ASSEMBLY GUIDE

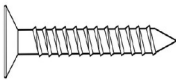
MÖBLER

1°

B	PARAFUSO 3,5X12mm	TORNILLO 3,5*12 SCREW 3,5*12	24	
C	PARAFUSO 4,0X35mm	TORNILLO 4,0*35 SCREW 4,0*35	10	
E	CHAPINHA DUPLA 42X42 "L"	4 HOLE CORNER ESQUINA DE 4 AGUREJOS	06	
J	PREGO 13X15	NAIL 13 X 15 CLAVO 13 X 15	10	
K	SAPATA DESLIZADORA	ZAPATA DESLIZANTE ZAMAC CONNER	05	

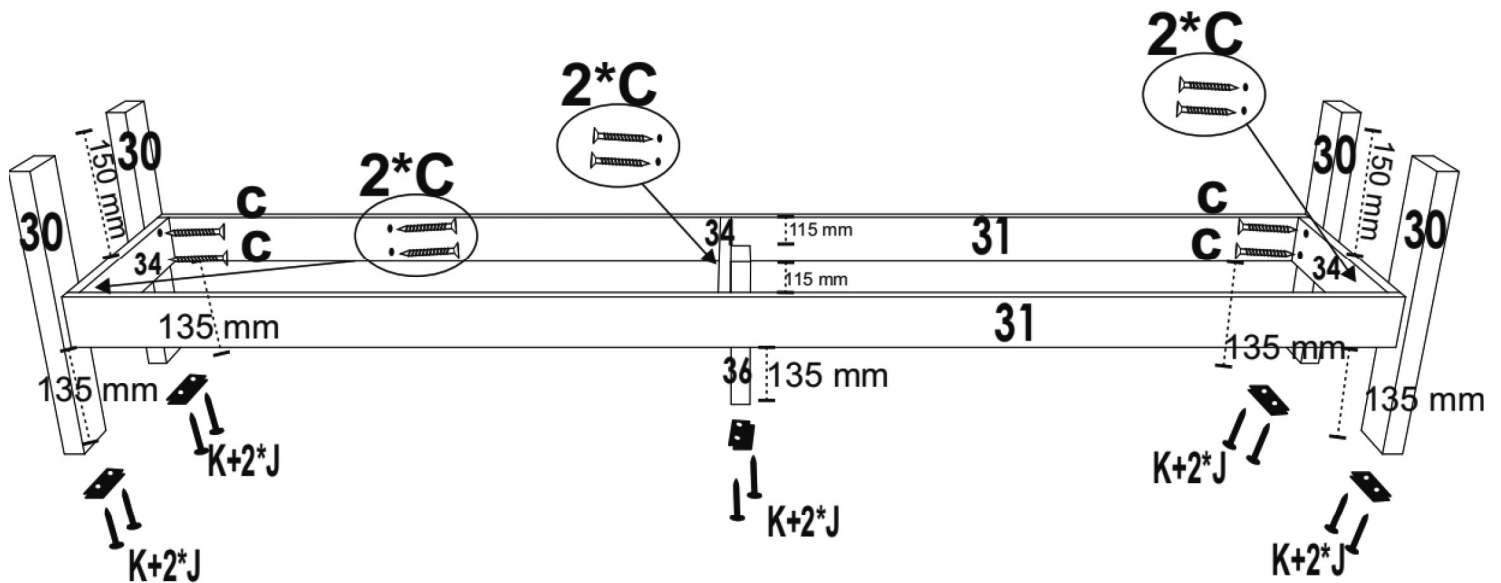
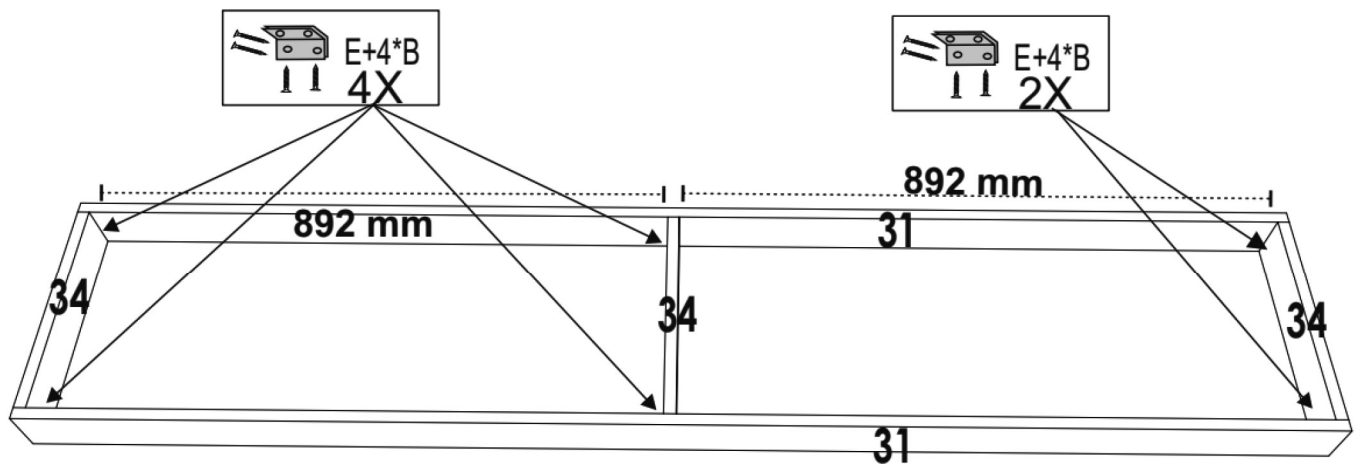

1005134 - BANCADA AURORA

MANUAL DE MONTAGEM - MANUAL DE MONTAJE - ASSEMBLY GUIDE

MÖBLER

2°

G	PERFIL GUIA ROLDANA 1796mm	GUIA DE POLEA DE PERFIL 1796mm PROFILE PULLEY GUIDE 1796mm	01	
---	----------------------------	---	----	---

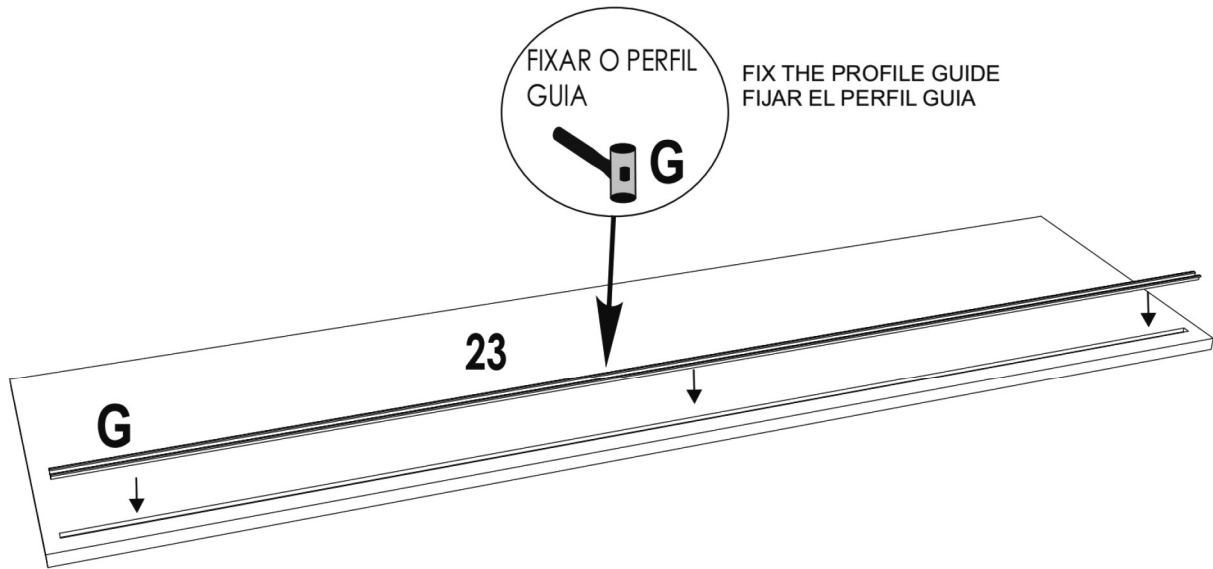

3°

A	CAVILHA 6X30mm	BOLSILLO DE MADERA WOODEN POCKET	06	
B	PARAFUSO 3,5X12mm	TORNILLO 3,5*12 SCREW 3,5*12	12	
D	PARAFUSO 35X4,0mm	TORNILLO 3,5*40 SCREW 3,5*40	10	
H	TAMPA DA CASTANHA 18mm 1°cor	PARTE SUPERIOR DEL TORNILLO SCREW TOP	04	
L	CANTONEIRA ZAMAC	CANTONEIRA ZAMAC ZAMAC CONNER	06	

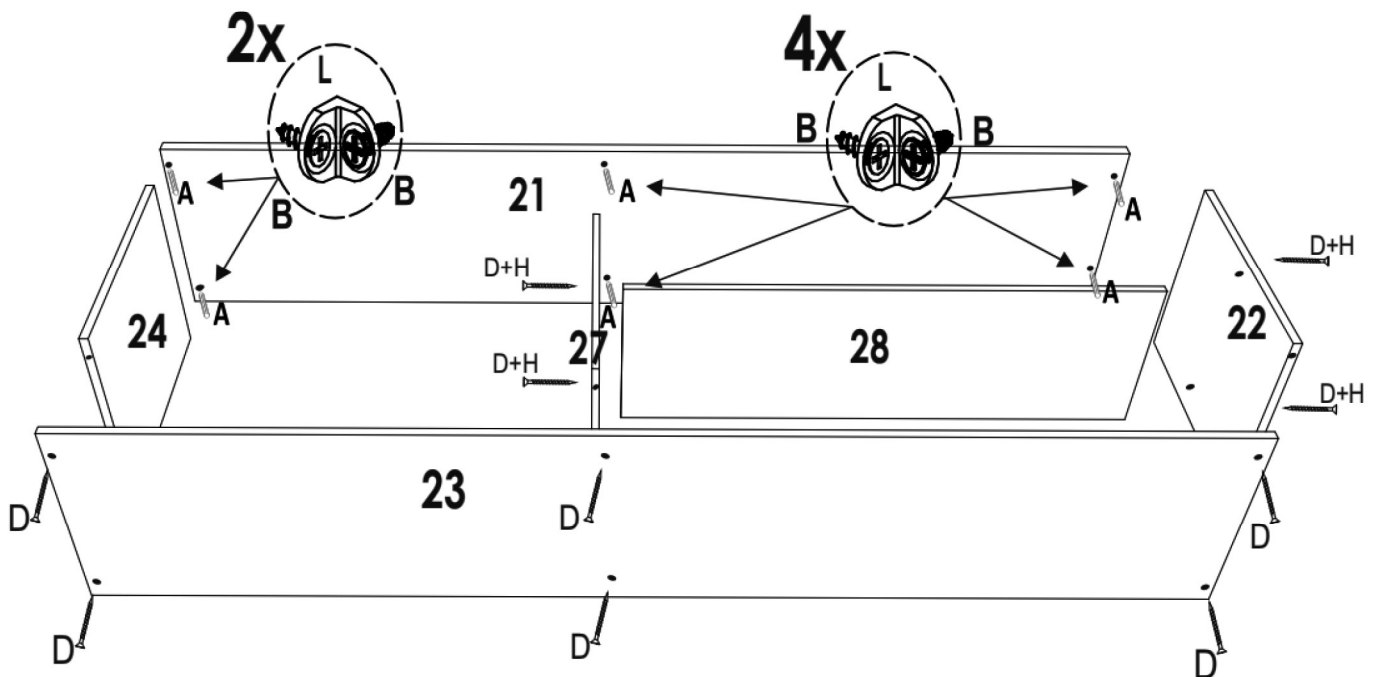

1005134 - BANCADA AURORA

MANUAL DE MONTAGEM - MANUAL DE MONTAJE - ASSEMBLY GUIDE



MÖBLER

4°

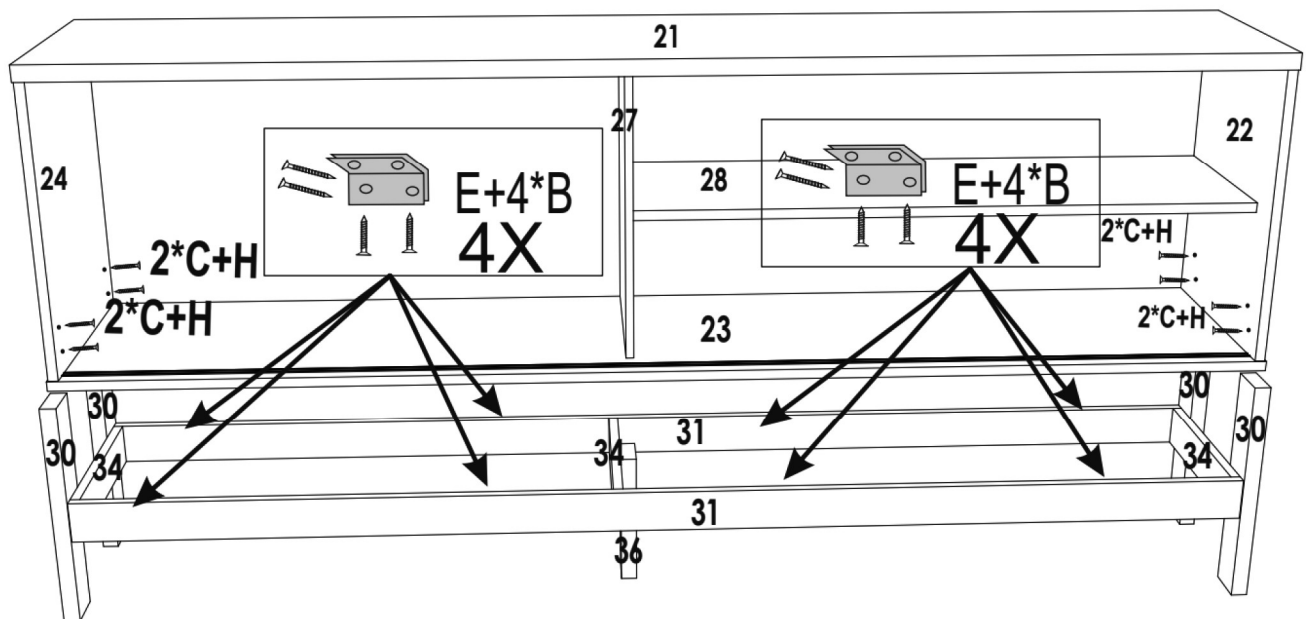
B	PARAFUSO 3,5X12mm	TORNILLO 3,5*12 SCREW 3,5*12	32	
C	PARAFUSO 4,0X35mm	TORNILLO 4,0*35 SCREW 4,0*35	08	
E	CHAPINHA DUPLA 42X42 "L"	4 HOLE CORNER ESQUINA DE 4 AGUREJOS	08	
H	TAMPA DA CASTANHA 18mm 1°cor	PARTE SUPERIOR DEL TORNILLO SCREW TOP	08	



5°

I	PREGO 8X8	NAIL 8 X 8 CLAVO 8 X 8	50	
F	PERFIL H 1796mm	PERFIL H 1796mm PROFILE H 1796mm	01	

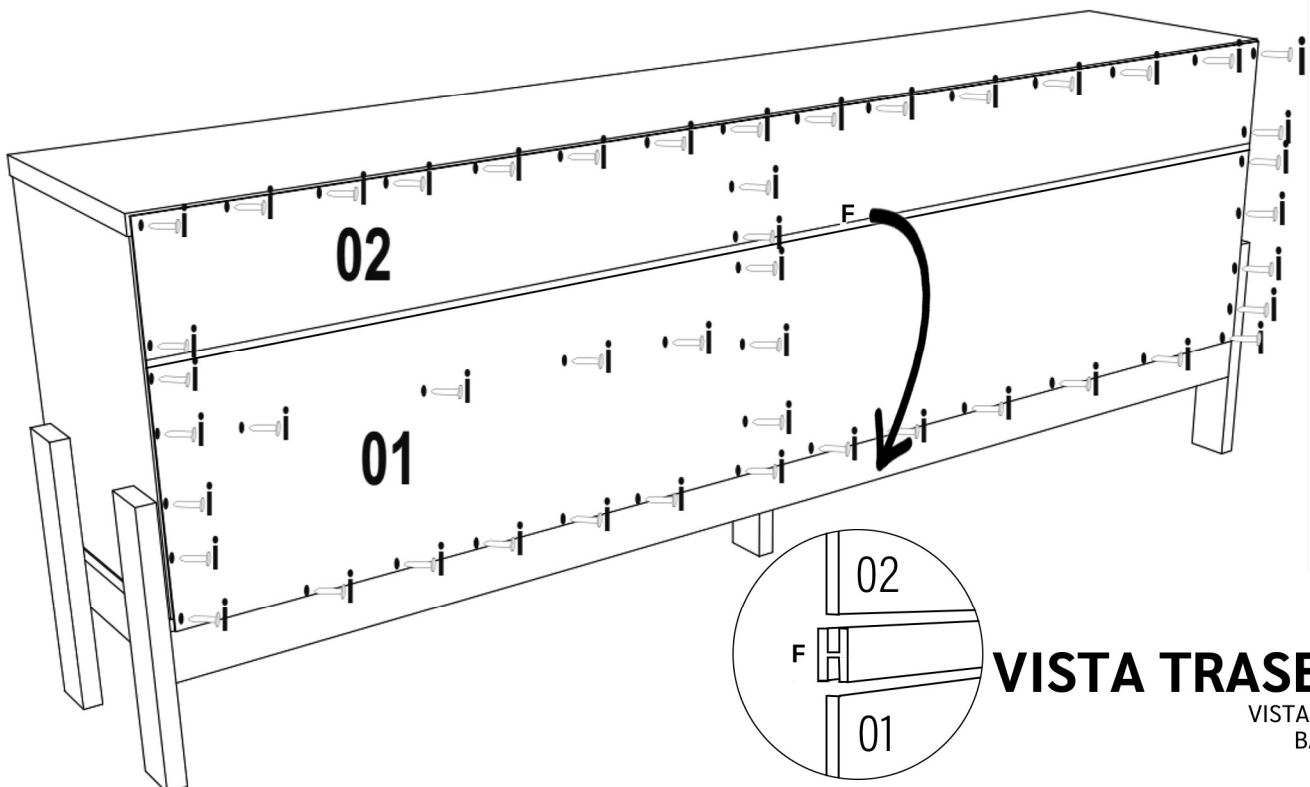

VISTA TRASEIRA
VISTA TRASERA
BACK VIEW

FIXAÇÃO DO ALINHADOR DE PORTA DE CORRER
FIJACION DEL ALINEADOR DE PUERTA DE CORRER/FIXING THE DOOR ALIGNMENT

6°

R	KIT ROLDANA CELSUS 1 PORTA	KIT ROLDANA 1 PUERTA KIT ROLLER 1 DOOR	01	
----------	-----------------------------------	---	-----------	---

1 - AFROUXE O PARAFUSO DA GUIA SUPERIOR E CONFIRME A REGULAGEM NÃO SENDO NECESSÁRIO QUE ENCOSTE NO FIM DA PEÇA N ° 32.

-AFROUXE EL TORNILLO DE LA GUÍA SUPERIOR Y CONFIRME LA REGULACIÓN NO SENDO NECESARIO QUE ENCOSTE EN FIN DE PIEZA N ° 32.

-LOOSEN THE BOLT OF THE UPPER GUIDE AND CONFIRM THE ADJUSTMENT NOT BEING NECESSARY TO PLACE AT THE END OF PART NO. 32.

2 - REGULE A GUIA SUPERIOR PARA QUE A PORTA DESLIZE SUAVEMENTE CONFIRMANDO A REGULAGEM DESEJADA

-REGULE LA GUÍA SUPERIOR PARA QUE LA PUERTA DESLIZA SUAVEMENTE CONFIRMANDO LA REGULACIÓN DESEADA.

-SET THE UPPER GUIDE FOR THE DOOR TO SMOOTHLY CONFIRMING THE DESIRED ADJUSTMENT

3 - FIXE O SEGUNDO PARAFUSO PARA NÃO CAIR A GUIA SUPERIOR.

-FECHA EL SEGUNDO TORNILLO PARA NO CAIR LA GUÍA SUPERIOR.

-FIX THE SECOND SCREW NOT TO DROP THE TOP GUIDE.

4 - APÓS COLOCAR PESO SOBRE O TAMPO DA PORTA FAZER UMA REGULAGEM A GUIA SUPERIOR DE MODO QUE A PORTA CORRA SUAVEMENTE.

-APÓS COLOCAR PESO SOBRE LA TAPA DE LA PUERTA HACER UNA REGULACIÓN LA GUÍA . GUÍA SUPERIOR DE MODO QUE LA PUERTA CORRIJA SUAVEMENTE.

-PLACES WEIGHT ON THE DOOR CAP MAKE AN ADJUSTMENT TO THE TOP GUIDE SO HAT THE DOOR RUNS SOFTLY.

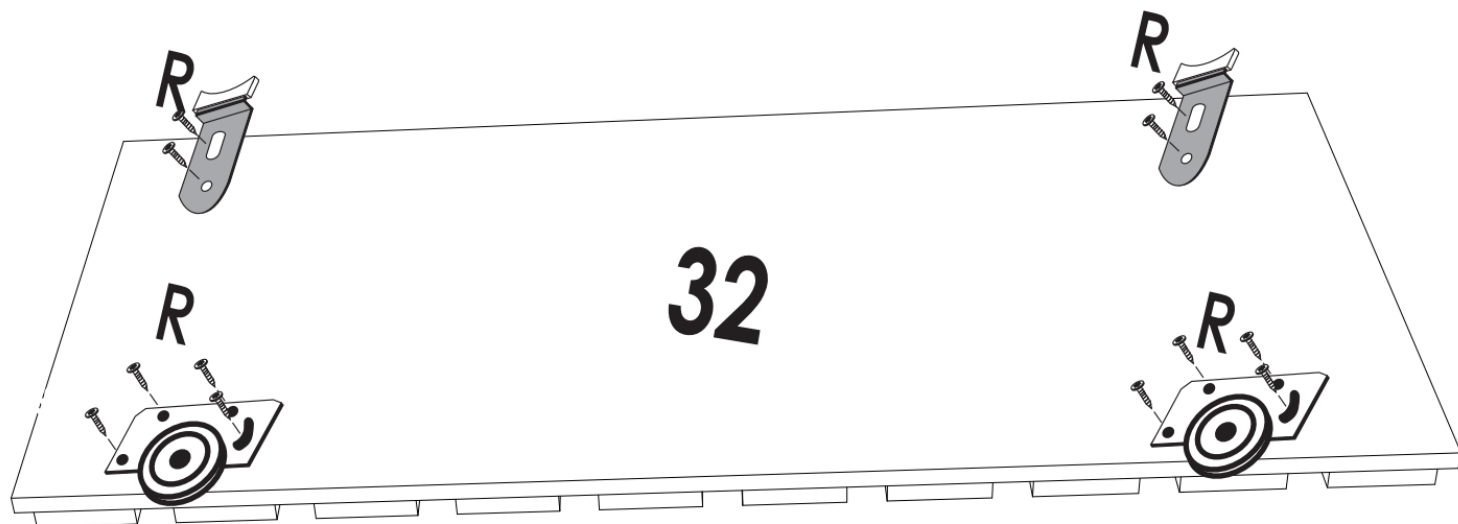

VISTA TRASEIRA

VISTA TRASERA
BACK VIEW

7°

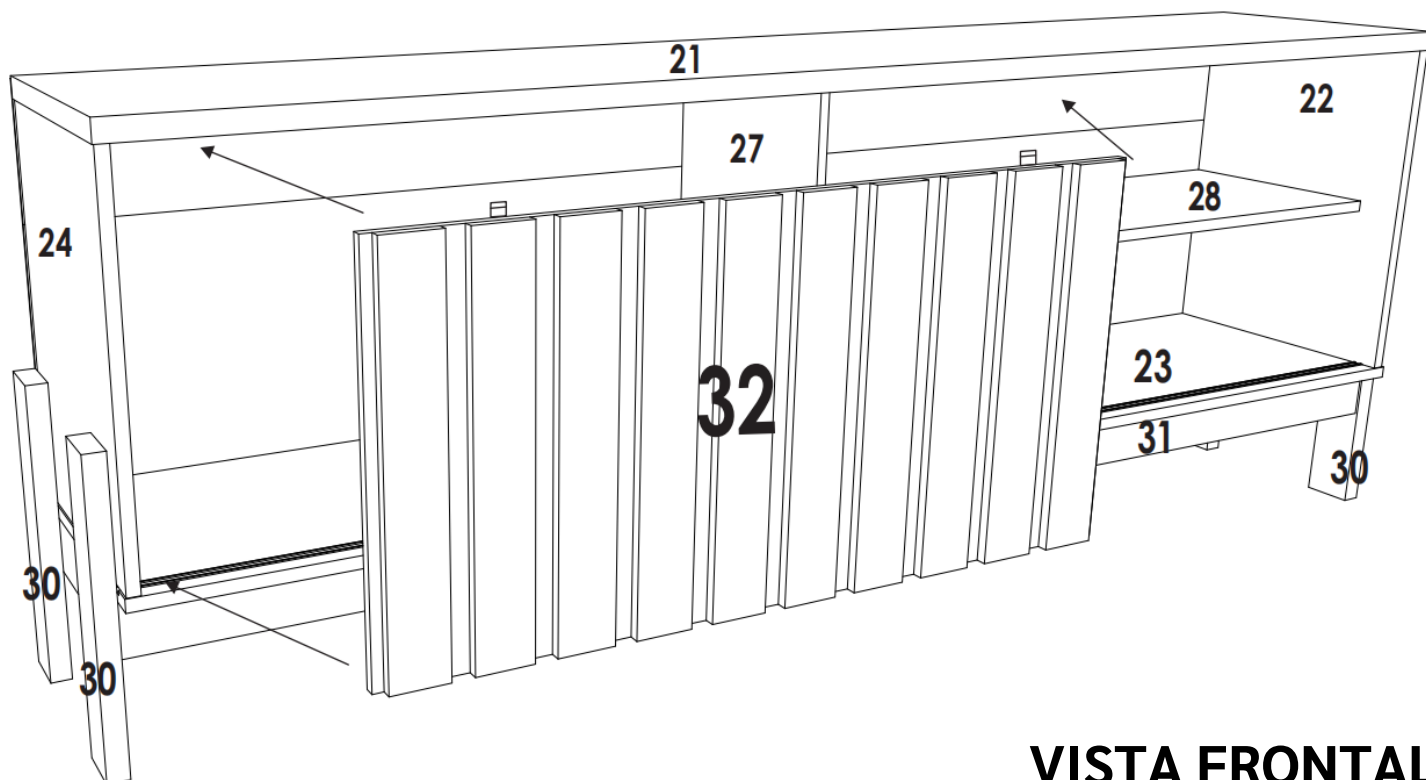

VISTA FRONTAL

VISTA FRONTA
FRONT VIEW



**Montagem final do
produto.**

**Final assembly of the
product.**

**Montaje final del
producto.**

MÖBLER

Rua floresta, nº08 - Jardim Santa Terezinha / Bela Vista do Paraíso - PR
Fale conosco: (0**43) 3242-8800 | Acesse nosso site: mobler.ind.br

 mobler.br  youtube.com/@MoblerMoveis