



# HITACHI

## ROTARY HAMMER

### MODEL DH 50SB

## INSTRUCTION MANUAL

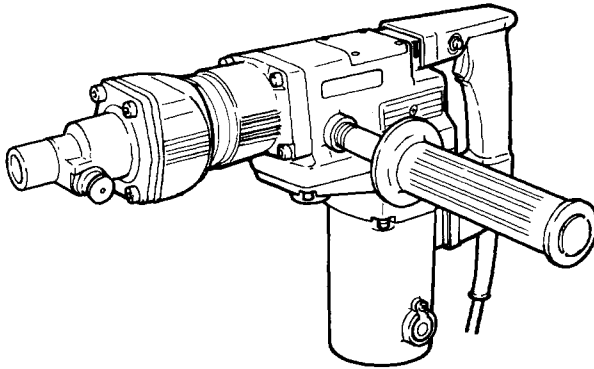

**Note:**

Before using this Electric Power Tool, carefully read through this INSTRUCTION MANUAL to ensure efficient, safe operation. It is recommended that this MANUAL be kept readily available as an important reference when using this power tool.



DOUBLE INSULATION

We sincerely thank you for selecting a HITACHI ELECTRIC POWER TOOL. To operate this electric power tool safely and efficiently, please read this INSTRUCTION MANUAL carefully to get a good understanding of the precautions in operation, capacity of the electric power tool, use and the like.

## **IMPORTANT INFORMATION: SAFETY RULES FOR POWER TOOLS**

**WARNING:** When using electric tools, basic safety precautions should always be followed to reduce the risk of fire, electric shock, and personal injury, including the following.

### **READ ALL INSTRUCTIONS**

- 1. KEEP WORK AREA CLEAN.** Cluttered areas and benches invite injuries.
- 2. CONSIDER WORK AREA ENVIRONMENT.**
  - Don't expose power tools to rain.
  - Don't use power tools in damp or wet locations.
  - Keep work area well lit.
  - Don't use tool in presence of flammable liquids or gases.
    - Power tools produce sparks during operation. They also spark when switching ON/OFF. Never use power tools in dangerous sites containing lacquer, paint, benzine, thinner, gasoline, gases, adhesive agents, and other materials which are combustible or explosive.
- 3. GUARD AGAINST ELECTRIC SHOCK.** Prevent body contact with grounded surfaces. For example; pipes, radiators, ranges, refrigerator enclosures.
- 4. KEEP CHILDREN AWAY.** Do not let visitors contact tool or extension cord. All visitors should be kept away from work area.
- 5. STORE IDLE TOOLS.** When not in use, tools should be stored in dry, and high or locked-up place-out of reach of children.
- 6. DON'T FORCE TOOL.** It will do the job better and safer at the rate for which it was intended.
- 7. USE RIGHT TOOL.** Don't force small tool or attachment to do the job of a heavy-duty tool.
  - Don't use tool for purpose not intended.
- 8. DRESS PROPERLY.** Do not wear loose clothing or jewelry. They can be caught in moving parts.
  - Rubber gloves and non-skid footwear are recommended when working outdoors.
  - Wear protective hair covering to contain long hair.
- 9. USE SAFETY GLASSES.** Also use face or dust mask if cutting operation is dusty.
  - All persons in the area where power tools are being operated should also wear safety eye protectors and face or dust masks.

10. **DON'T ABUSE CORD.** Never carry tool by cord or yank it to disconnect from receptacle. Keep cord from heat, oil, and sharp edges.
11. **SECURE WORK.** Use clamps or a vise to hold work. It's safer than using your hand and it frees both hands to operate tool.
12. **DON'T OVERREACH.** Keep proper footing and balance at all times.
13. **MAINTAIN TOOLS WITH CARE.** Keep tools sharp and clean for better and safer performance.  
Follow instructions for lubricating and changing accessories.  
Inspect tool cords periodically and if damaged, have repaired by authorized service facility.  
Inspect extension cords periodically and replace if damaged.  
Keep handles dry, clean, and free from oil and grease.
14. **DISCONNECT TOOLS.** When not in use, before servicing, and when changing accessories, such as blades, bits, cutters.
15. **REMOVE ADJUSTING KEYS AND WRENCHES.** Form habit of checking to see that keys and adjusting wrenches are removed from tool before turning it on.
16. **AVOID UNINTENTIONAL STARTING.** Don't carry plugged-in tool with finger on switch. Be sure switch is off when plugging in.
17. **OUTDOOR USE EXTENSION CORDS.** When tool is used outdoors, use only extension cords intended for use outdoors and so marked.
18. **STAY ALERT.** Watch what you are doing. Use common sense. Do not operate tool when you are tired.
19. **CHECK DAMAGED PARTS.** Before further use of the tool, a guard or other part that is damaged should be carefully checked to determine that it will operate properly and perform its intended function. Check for alignment of moving parts, binding of moving parts, breakage of parts, mounting, and any other conditions that may affect its operation. A guard or other part that is damaged should be properly repaired or replaced by an authorized service center unless otherwise indicated elsewhere in this instruction manual.  
Have defective switches replaced by authorized service center.  
Do not use tool if switch does not turn it on and off.
20. **AVOID USING A POWER TOOL FOR APPLICATIONS OTHER THAN THOSE SPECIFIED.** Never use a power tool for applications other than those specified in the instruction manual.
21. **ENSURE SAFE OPERATION THROUGH CORRECT HANDLING.** Secure safe operation through correct handling by observing the instructions described herein.  
Do not employ accessories other than those specified herein; otherwise, a hazardous condition may be created.  
Never allow a power tool to be used by persons not familiar with correct handling (such as children) or by those who cannot handle the tool correctly.

- 22. CONFIRM THAT NO ITEMS SUCH AS AN ELECTRIC CABLE OR CONDUIT ARE BURIED INSIDE.** In places where live wiring may be hidden behind a wall, floor, ceiling, etc. do not hold or contact any metal parts of the tool. In such cases, metal parts could become electrically live and present a serious shock hazard.
- 23. KEEP THE RIGHT PARTS IN THE RIGHT POSITIONS.** Do not remove covers and screws which have been factory-mounted. They perform important respective roles. Keep them in the right positions.
- 24. SHOULD THE PLASTIC HOUSING OR HANDLE OF A POWER TOOL BE CRACKED OR DEFORMED, DO NOT USE IT.** Since cracked or deformed parts may lead to an operator receiving an electric shock, do not use such a power tool. Immediately have it repaired.
- 25. SECURELY MOUNT ACCESSORIES AND BLADES TO THE TOOL MAIN BODY.** Extra care must be taken when using tools on elevated location (such as a roof ladder, scaffold, or the like) to prevent injury to someone on a lower level in the event the tool and/or accessory should drop.
- 26. ALWAYS KEEP THE MOTOR AIR VENT FULLY OPENED.** A constantly open motor air vent is necessary to allow air to come in and out for cooling the motor. Do not allow it to become clogged up, even if dust is blown through it.
- 27. OPERATE POWER TOOLS AT THE RATED VOLTAGE.** Operate power tools at voltages specified on their nameplates.
- 28. NEVER TOUCH THE MOVING PARTS.** Never touch the moving parts such as blades, bits, cutters and others.
- 29. STOP OPERATION IMMEDIATELY IF ANY ABNORMALITY IS DETECTED.** Should a power tool be detected as out of order or should other abnormalities be observed during operation, stop using the tool immediately.
- 30. NEVER LEAVE TOOL RUNNING UNATTENDED. TURN POWER OFF.** Don't leave tool until it comes to a complete stop.
- 31. CAREFULLY HANDLE POWER TOOLS.** Should a power tool be dropped or struck against hard materials inadvertently, it may be deformed, cracked, or damaged.
- 32. DO NOT WIPE PLASTIC PARTS WITH SOLVENT.** Solvents such as gasoline, thinner, benzine, carbon tetrachloride, and alcohol may damage and crack plastic parts. Do not wipe them with such solvents. Wipe plastic parts with a soft cloth lightly dampened with soapy water.
- 33. WHEN REPLACING A COMPONENT PART, ADOPT THE SAME TYPE.** When replacing a component part with a new one, adopt the same type of new part. Also, never attempt to repair a power tool yourself.

# SAVE THESE INSTRUCTIONS

## SERVICE AND REPAIRS

All quality tools will eventually require servicing or replacement of parts due to wear from normal use. These operations should **ONLY** be performed by an **AUTHORIZED HITACHI POWER TOOL REPAIR SHOP**.

## REPLACEMENT PARTS

When servicing use only identical replacement parts.

## DOUBLE INSULATION SYSTEM ENHANCES SAFE OPERATION

To enhance safe operation of this electric power tool, HITACHI has adopted a double insulation system. The term "double insulation" used here denotes an insulation system with two insulations physically separated and arranged between the electrically conductive material connected to the power supply and the outer frame subject to contact by the operator.

Thus, the power tool is termed double insulated and both the "□" mark and "Double insulation", or either one is indicated on the name plate.

While no external grounding is required with this system, normal safety precautions as outlined in this manual must still be followed.

To maintain the effectiveness of the double insulation system, follow the precautions described below:



1. Always contact your dealer or an authorized HITACHI service agent when assembling, disassembling or replacing parts other than accessories or carbon brushes. Improper assembly and/or replacement with wrong parts may result in eliminating the double insulation-feature.
2. Clean the exterior of the tool with a soft cloth moistened with soapy water, and dry thoroughly. Chloric solvent, gasoline, and thinner will cause plastic components to dissolve.

## PRECAUTION ON USING ROTARY HAMMER

1. Wear ear protectors when using for extended periods.
2. Always attach the side handle and securely grip the Rotary Hammer.
3. Do not touch the tool bit with one's bare hands after operation.
4. Do not wear gloves made of stuff liable to roll up such as cotton, wool, cloth or string, etc.

## NAME OF PARTS

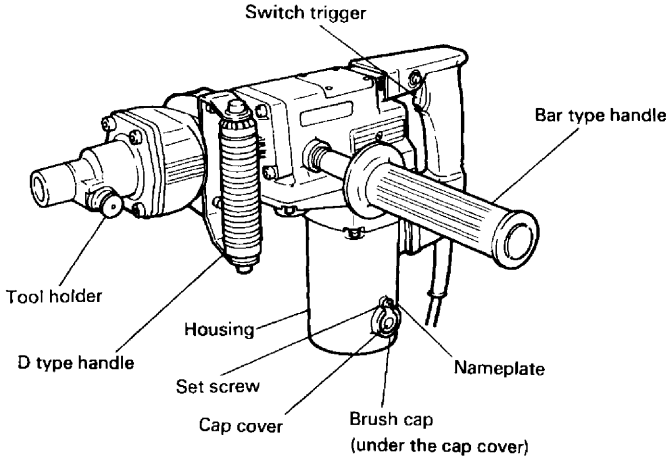

Fig. 1

## SPECIFICATIONS

Motor .....	Single-Phase, Series Commutator Motor
Power Source.....	Single-Phase 115V AC 60 Hz
Current .....	10.4A
Capacity .....	Drill Bit: 2"
	Core Bit: 5"
No-load Speed .....	300 rpm
Full-load Impact Rate.....	2450 bpm
Weight .....	19.2 lbs

**OPTIONAL ACCESSORIES (sold separately)**

- Through-hole drilling (Rotation + Striking)

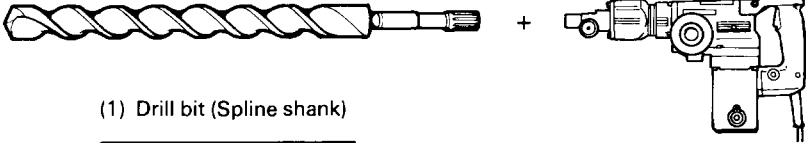

(1) Drill bit (Spline shank)

External dia.	Total length
1/2"	16"
1"	
1-1/2"	
2"	

- Anchor hole drilling (Rotation + Striking)



(3) Cotter

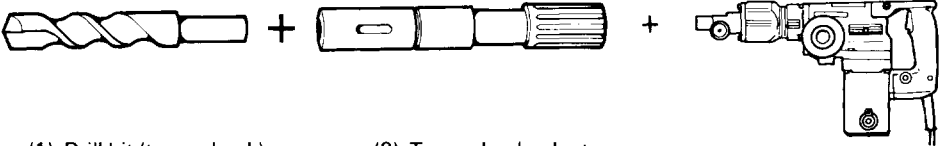

(1) Drill bit (taper shank)

(2) Taper shank adapter

A-taper	Taper shank adapter formed A-taper or B-taper is provided as optional accessory, but drill bit for it is not provided.
B-taper	

- Large-dia. hole boring (Rotation + Striking)

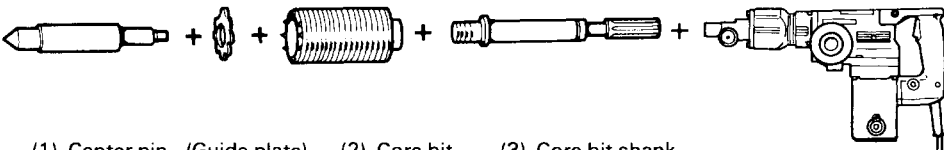

(1) Center pin (Guide plate) (2) Core bit (3) Core bit shank

External dia.
2"
4-1/8"
5"

○ Crushing (striking)



+

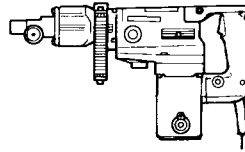

(1) Bull point

Total length
12"
18"

○ Groove digging and edging (striking)

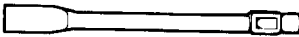

+

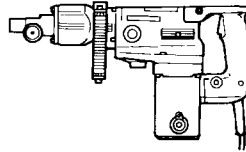

(1) Cold chisel

Total length
12"
18"

○ Asphalt cutting (striking)

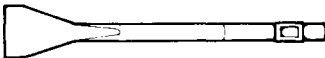

+

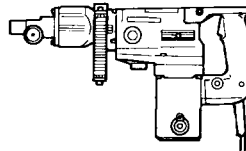

(1) Cutter

Total length	Width
12"	1-1/2"
	2"

○ Syringe (for chip removal)

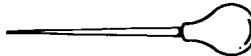

○ Digging

(1) Scoop

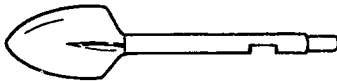

○ Hammer grease A: 500g (in a can)

**APPLICATIONS**

- Drilling holes in concrete
- Drilling anchor holes
- Crushing concrete, chipping, digging, and squaring (by applying optional accessories)



## PRIOR TO OPERATION

### 1. Power source

Ensure that the power source to be utilized conforms to the power requirements specified on the product nameplate.

### 2. Power switch

Ensure that the power switch is in the OFF position. If the plug is connected to a power receptacle while the power switch is in the ON position, the power tool will start operating immediately, inviting serious accident.

### 3. Extension cord

When the work area is removed from the power source, use an extension cord of sufficient thickness and rated capacity. The extension cord should be kept as short as practicable.

#### CAUTION:

Damaged cord must be replaced or repaired.

### 4. Confirming condition of the environment

Confirm that the work site is placed under appropriate conditions conforming to prescribed precautions.

### 5. Confirming the power receptacle

If the power receptacle only loosely accepts the plug, the receptacle must be repaired. Contact the nearest electric store for repair service.

If such a faulty receptacle is used, it may cause overheating, resulting in a serious hazard.

### 6. How to install dust cover

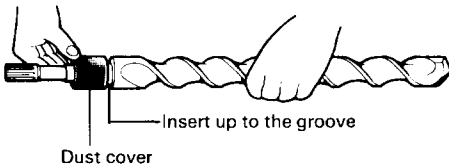

Fig. 2

Always install the dust cover in the drill bit or the taper shank adapter.

Insert the dust cover until it lies flush in the groove.

#### NOTE:

For a thick drill bit, insert the dust cover from drill rear.

### 7. How to install tool

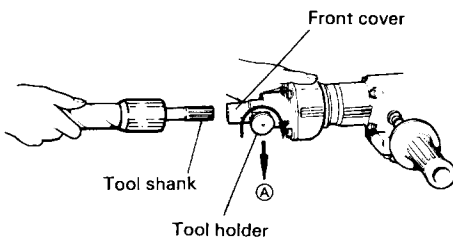

Fig. 3

#### NOTE:

For tools such as a bull point and a cold chisel, use only Hitachi genuine parts.

(1) Clean, then smear the tool shank with the grease provided.

(2) Slide the tool holder in the direction of arrow (A) and rotate it 180°.

Turn the notch of the tool shank downward and insert it fully into the hexagonal hole of the front cover. (Fig. 3)

(3) Turn the tool holder and align the front cover mark with the tool holder mark to secure.

#### NOTE:

Remove in the reverse order to installation.

# HOW TO USE THE ROTARY HAMMER

## 1. How to drill holes

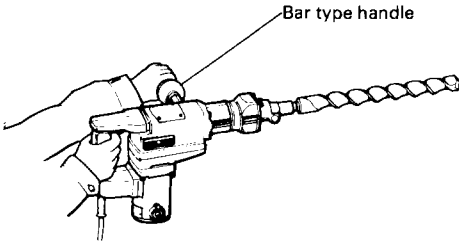

Fig. 4

- (1) Use the Bar type handle.  
Do not use D type handle when drilling operation, since it may not be enough to hold the body firmly.
- (2) Pull the switch trigger after applying the drill bit tip to the drilling position.
- (3) It is unnecessary to forcibly press the rotary hammer main body. It is sufficient to slightly press the rotary hammer to an extent that chips are freely discharged.

### CAUTION:

Although this machine is equipped with a safety clutch, if the drill bit becomes bound in concrete or other material, the resultant stoppage of the drill bit could cause the machine body to turn in reaction. Ensure that the main handle and bar type handle are gripped firmly during operation.

## 2. How to chip or crushing

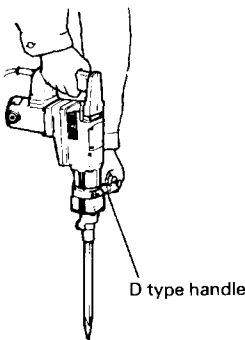
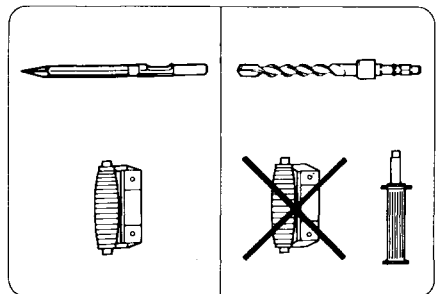

Fig. 5

- (1) Use the D type handle.
- (2) By applying the bull point tip to the chipping or crushing position, operate the rotary hammer by utilizing its own weight.  
Forcible pressing or thrusting is unnecessary.



## DRILLING AND DRIVING-IN OPERATIONS FOR ANCHORS

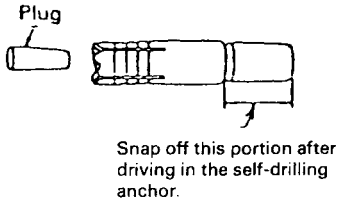

Fig. 6

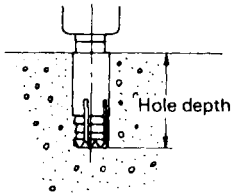

Fig. 7

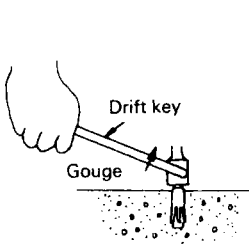

Fig. 8

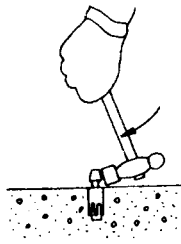

Fig. 9

Use the optional accessories for anchors, such as anchor adapter and taper shank adapter.

### 1. When a rotation-striking anchor adapter is used.

- (1) Install the self-drilling anchor in the anchor adapter (Fig. 6).
- (2) Turn on the switch and drill a base hole with the self-drilling anchor. (Fig. 7)  
At the start of the hole-drilling slightly tilt the hammer drill to determine the hole position.
- (3) After cleaning out dust with a syringe, attach the plug to the anchor tip and drive in the anchor with a hand hammer.
- (4) After driving in the anchor, use the drift key to separate the anchor. (Fig. 8)
- (5) By employing a hand hammer or pliers, snap off the tapered portion of the anchor. (Fig. 9)

### CAUTION:

Since the snapped-off tapered portion will fly about, pay attention to the snapping direction.

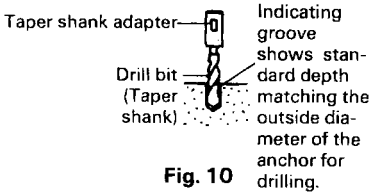

**Fig. 10**

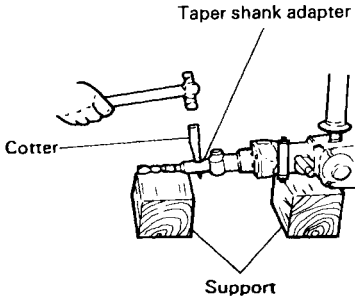

**Fig. 11**

## HOW TO HANDLE A CORE BIT

When a core bit is used, large caliber holes and blind holes can be drilled. In this case, use optional accessories for core bits (such as a center pin and core bit shank) for more rational operation.

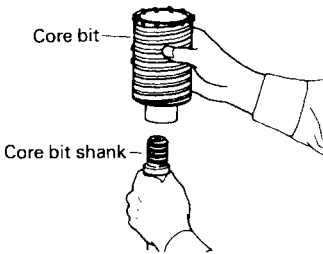

**Fig. 12**

### 2. When a taper shank adapter is used. (Fig. 10)

- (1) Install drill bit with taper shank in the taper shank adapter.
- (2) Turn the power on and drill a base hole to the depth sounded by indicating groove on the drill bit.
- (3) After cleaning out dust with a syringe, attach the plug to the anchor tip and drive in the anchor with a hand hammer.
- (4) To remove the drill bit with taper shank, insert a cotter into the slot of the taper shank adapter, place supports under the rotary hammer and tap the cotter with a hand hammer. (Fig. 11)

### 1. Mounting

#### CAUTION:

Prior to mounting a core bit, always disconnect the plug from the power supply receptacle.

- (1) Mount the core bit on the core bit shank. (Fig. 12) Before that, feed oil the screw portion of core bit shank for easily dismount.
- (2) Mount the core bit shank on the main body in the same manner as in mounting the drill bit and the bull point. (Fig. 13)
- (3) Insert the center pin into the guide plate until it reaches the extremity.

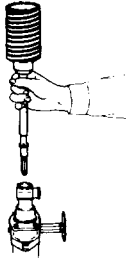

Fig. 13

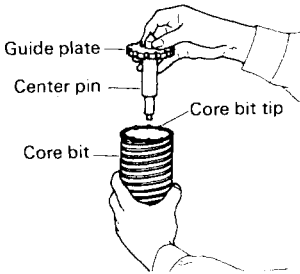

Fig. 14

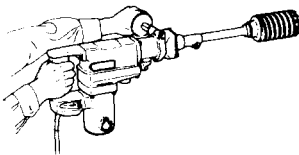

Fig. 15

- (4) Fit in the guide plate by aligning its concave portion with the core bit tip. When the position of the concave is shifted by turning the guide plate right or left, the guide plate never slips off even when the rotary hammer is used in a downward direction. (Fig. 14)

## 2. Drilling holes

- (1) Insert the plug into a power supply receptacle.
- (2) A spring is built in the center pin. By straightly and gently pressing it to the wall or floor surface, the entire surface of the core bit tip attains contact to start the hole drilling job. (Fig. 15)
- (3) When the hole depth reaches approximately  $3/16$ ", the hole position can be determined. Then remove the center pin and guide plate from the core bit and continue the hole drilling job.

### CAUTION:

When removing the center pin and guide plate, always disconnect the plug from the power supply receptacle.

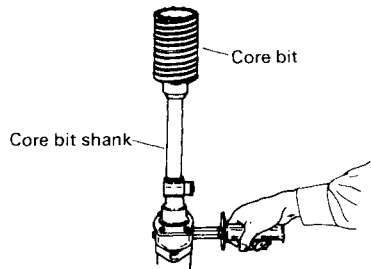

Fig. 16

## 3. How to dismount the core bit (Fig. 16)

- (1) By holding the rotary hammer (with the core bit inserted) in an upward position, drive the rotary hammer to repeat impact operation two or three times, whereby the screw is loosened and the rotary hammer becomes ready for disassembly.
- (2) Remove the core bit shank from the rotary hammer, hold the core bit with one hand, and strongly strike the head of the hexagonal portion of the core bit shank with a hand hammer two or three times, whereby the round head screw is loosened and the rotary hammer is ready for disassembly.

## HOW TO REPLACE GREASE

This machine is full air-tight construction to protect against dust and to prevent lubricant leakage. Therefore, the machine can be used without lubrication for long periods. Replace the grease as described below.

### 1. Grease replacement period

After purchase, replace grease after every 6 months of usage. Ask for grease replacement at the nearest authorized HITACHI Service Agent. Proceed for replacement of grease.

### 2. Grease replacement

#### CAUTION:

Before replacing the grease, turn the power off and pull out the power plug.

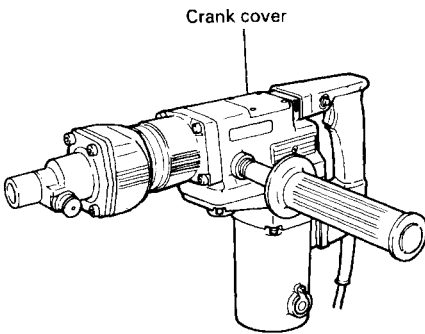

Fig. 17

- (1) Remove the crank cover and wipe off the grease inside. (Fig. 17)
- (2) Supply 0.7 oz of HITACHI Electric Hammer Grease A (standard accessory, contained in tube) to the crank case. As the tube contains 1 oz of grease, supply 2/3 of the contained grease.
- (3) After replacing the grease, install the crank case securely.

#### NOTE:

The HITACHI Electric Hammer Grease A is of the lower viscosity type. When the supplied grease tube is consumed, purchase from an authorized HITACHI Service Agent.

## MAINTENANCE AND INSPECTION

#### CAUTION:

Be sure to switch power OFF and disconnect the plug during maintenance and inspection.

### 1. Inspecting the tool:

Since use of a dull tool will degrade efficiency and cause possible motor malfunction, sharpen or replace the tool as soon as abrasion is noted.

### 2. Inspecting the mounting screws:

Regularly inspect all mounting screws and ensure that they are properly tightened. Should any of the screws be loose, retighten them immediately. Failure to do so could result in serious hazard.

### 3. Inspecting the carbon brushes: (Fig. 18)

The motor employs carbon brushes which are consumable parts. When they become worn to or near "wear limit", it could result in motor trouble. When an auto-stop carbon brush is equipped, the motor will stop automatically. At that time, replace both carbon brushes with new ones which have the same carbon brush Nos. shown in the figure.

In addition, always keep carbon brushes clean and ensure that they slide freely within the brush holders.

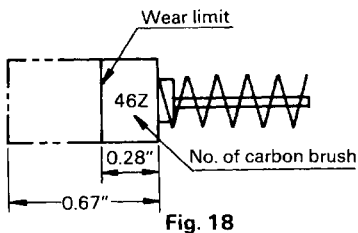

Fig. 18

#### 4. Replacement procedure:

(For parts name, refer to Fig. 1)

Loosen the set screw and remove the cap cover. Remove the brush cap and carbon brush. After replacing the carbon brush, do not forget to tighten the brush cap securely and to install the cap cover.

---

#### Note:

Due to HITACHI's continuing program of research and development, the specifications herein are subject to change without prior notice.

---

# **Hitachi Koki Co.,Ltd.**

Nippon Bldg., 2-6-2, Ohtemachi,  
Chiyoda-Ku, Tokyo 100, Japan