

TL3305 SERIES TACT SWITCH

ANTI-VANDAL SWITCHES
 DETECTOR SWITCHES
 DIP SWITCHES
 KEYLOCK SWITCHES
 NAVIGATION SWITCHES
 PUSHBUTTON SWITCHES
 ROCKER SWITCHES
 ROTARY SWITCHES
 SLIDE SWITCHES
 SNAP ACTION SWITCHES
TACTILE SWITCHES
 TOGGLE SWITCHES
 CAP OPTIONS

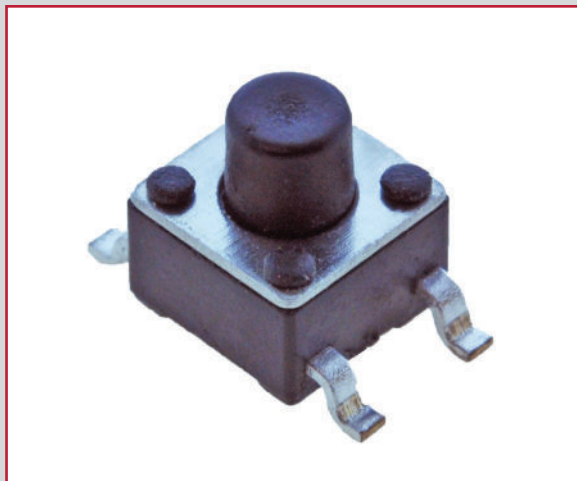

APPLICATIONS / MARKETS



Wearable Technology

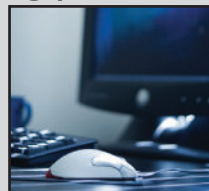

Computer Peripherals



Consumer Electronics

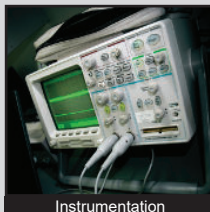

Instrumentation



Telecommunication

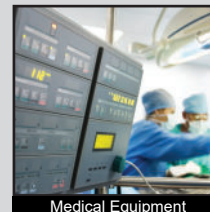

Medical Equipment

RoHS

SPECIFICATIONS

Electrical Rating: 50mA @ 12VDC
Electrical Life:
 160 gf = 500,000 Cycles
 260 gf = 200,000 Cycles
Contact Resistance: 100mΩ Max
Insulation Resistance: 100MΩ Min. at 100VDC
Dielectric Strength: 250VAC for 1 min.
Operating Temperature: -20°C to 70°C
Storage Temperature: -30°C to 80°C
Operating Force: 160 gf, 260 gf
Travel: 0.20mm
Contact Arrangement: SPST, normally open

FEATURES & BENEFITS

- Ultra-miniature 4.5 x 4.5mm
- Multiple actuator options
- Surface mount
- Multiple operating force options

PART NUMBER CONFIGURATOR

Series	Model	Actuator Option	Actuation Force	Contact Material	Termination
<input type="text" value="TL"/>	<input type="text" value="3305"/>	<input type="text" value="A"/>	<input type="text" value="F160"/> <input type="text" value="F260"/>	<input type="text" value="Q"/>	<input type="text" value="G"/>
		A - 3.8mm B - 5.0mm C - 7.0mm	F160 - 160 gf F260 - 260 gf	Q - Silver	G - Gullwing

Specifications subject to change without notice 9.28.2022



E-SWITCH®

www.e-switch.com

800.867.2717

1

TL3305 SERIES TACT SWITCH

BODY DIMENSIONS

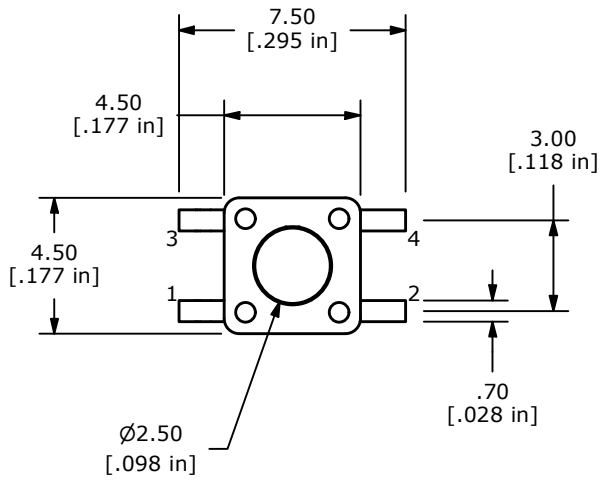

ACTUATOR OPTION	"L" DIMENSION
A	3.80
B	5.00
C	7.00

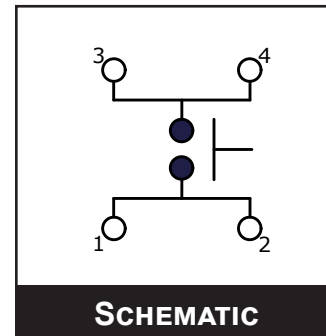
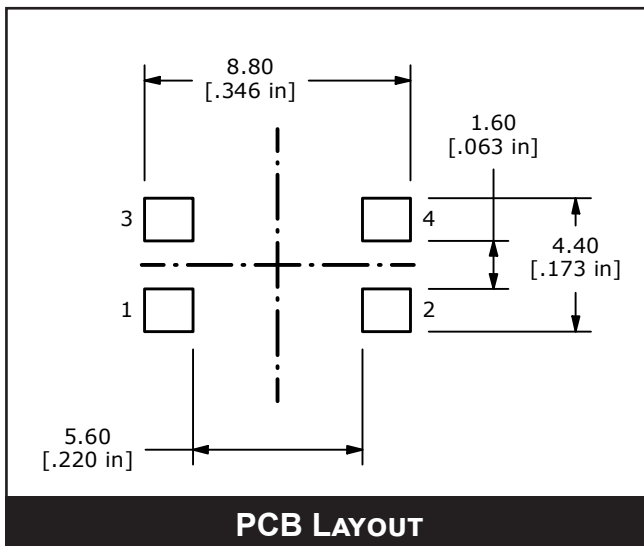
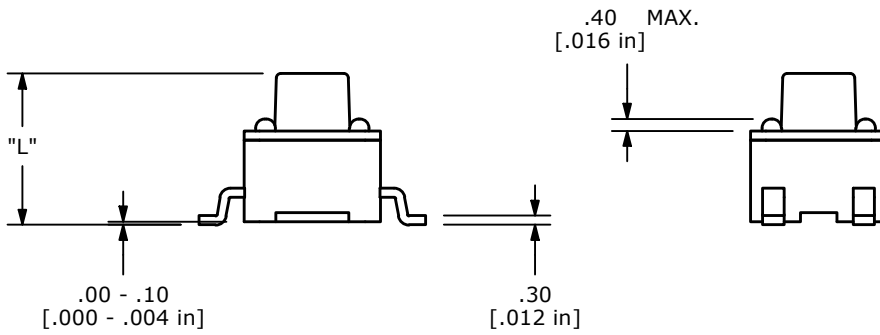

- ANTI-VANDAL SWITCHES
- DETECTOR SWITCHES
- DIP SWITCHES
- KEYLOCK SWITCHES
- NAVIGATION SWITCHES
- PUSHBUTTON SWITCHES
- ROCKER SWITCHES
- ROTARY SWITCHES
- SLIDE SWITCHES
- SNAP ACTION SWITCHES
- TACTILE SWITCHES
- TOGGLE SWITCHES
- CAP OPTIONS

