

DO NOT SCALE FROM THIS PRINT

-XX	-S, -D, -T, -P	-S-RA, -P-RA	-D-RA	-T-RA
-01	C-08-1-XXX	N/A	N/A	N/A
-02	C-08-2-XXX	C-08-2-XXX	C-08-2-XXX C-08-3-XXX	C-08-2-XXX C-08-3-XXX C-08-5-XXX
-03	C-08-3-XXX	C-08-3-XXX	C-08-3-XXX C-08-5-XXX	N/A
-04	C-08-5-XXX	C-08-5-XXX	N/A	N/A
-06	C-08-6-XXX	N/A	N/A	N/A
-21	C-17-1-XXX	N/A	N/A	N/A
-22	C-17-2-XXX	C-17-2-XXX	C-17-2-XXX C-17-3-XXX	C-17-2-XXX C-17-3-XXX C-17-5-XXX
-23	C-17-3-XXX	C-17-3-XXX	C-17-3-XXX C-17-5-XXX	N/A
-24	C-17-5-XXX	C-17-5-XXX	N/A	N/A

ROW OPTION	BODY
-S	SSW-XX-S
-D	SSW-XX-D
-D-N	NSW-XX-D-N-XX
-T	SSW-XX-T
-P	SSW-XX-P
-Q	SSW-XX-T

No OF POSITIONS  
-01 THRU -50  
(-P OPTION: 36 POS MAX)

LEAD STYLE  
(SEE TABLE 1)  
-01 THRU -06 (STD. INS. FORCE)  
-21 THRU -24 (LOW INS. FORCE)

PLATING SPECIFICATION

- G: 20µ" GOLD IN CONTACT AREA, 3µ" GOLD ON TAIL
- T: MATTE TIN CONTACT AND TAIL (CONTACT -21 THRU -24 N/A)
- S: 30µ" SELECTIVE GOLD IN CONTACT AREA, MATTE TIN ON TAIL
- H: 30µ" HEAVY GOLD IN CONTACT AREA, 3µ" GOLD ON TAIL
- E: 50µ" EXTRA HEAVY GOLD IN CONTACT AREA, 3µ" GOLD ON TAIL (CONTACT -01 & -02 STRAIGHT ONLY)
- F: 3µ" FLASH SELECTIVE GOLD IN CONTACT AREA, MATTE TIN ON TAIL
- STL: 30µ" SELECTIVE GOLD IN CONTACT AREA, TIN/LEAD (90/10 ± 5%) TAIL
- TL: TIN/LEAD (90/10 ± 5%) CONTACT AND TAIL (AVAILABLE ONLY ON LEAD STYLES -01)
- TM: MATTE TIN CONTACT AND TAIL (CONTACT -21 THRU -24 N/A)
- SM: 30µ" SELECTIVE GOLD IN CONTACT AREA, MATTE TIN ON TAIL
- FM: 3µ" FLASH GOLD SELECTIVE IN CONTACT AREA, MATTE TIN ON TAIL
- L: 10µ" LIGHT SELECTIVE GOLD IN CONTACT AREA, MATTE TIN ON TAIL

OPTION  
-LL: LOCKING LEAD (SEE FIG 4, SHT 2) (N/A IN SINGLE ROW, 1 & 2 POSITION)

POLARIZING OPTION  
INDICATE POS, SEE FIG 3, SHT 3

OPTION  
-RA: RIGHT ANGLE (SEE FIG 2, SHT 2) (STYLE -01 & -21 N/A)  
-N: NOTCH (SEE FIG 6, SHT 3) (ONLY AVAILABLE IN -D ROW) (ONLY AVAILABLE IN 5, 7, 8, 10, 12, 13, 15, 17, 20, 25, 32, 36 POSITIONS) (USE NSW-XX-D-N-XX BODY, SEE TABLE 6)

ROW SPECIFICATION

-S: SINGLE  
-D: DOUBLE  
-T: TRIPLE  
-P: SINGLE  
-Q: TRIPLE WITH ONLY OUTER 2 ROWS FILLED

LEAD STYLE	"B"	"G"	"C" REF		
	-S(-RA), -D, -T	-D, -T	-S-RA	-D-RA	-T-RA
-01, -21	.104[2.64]	.005 [.13]	N/A	N/A	N/A
-02, -22	.194[4.93]	.005 [.13]	.100[2.54]	.100[2.54]	.100[2.54]
-03, -23	.394[10.01]	+ .010/- .012 [+ .25/- .31]	.300[7.62]	.300[7.62]	N/A
-04, -24	.584[14.83]	+ .010/- .012 [+ .25/- .31]	.490[12.45]	N/A	N/A
-06	.124[3.15]	.005 [.13]	N/A	N/A	N/A

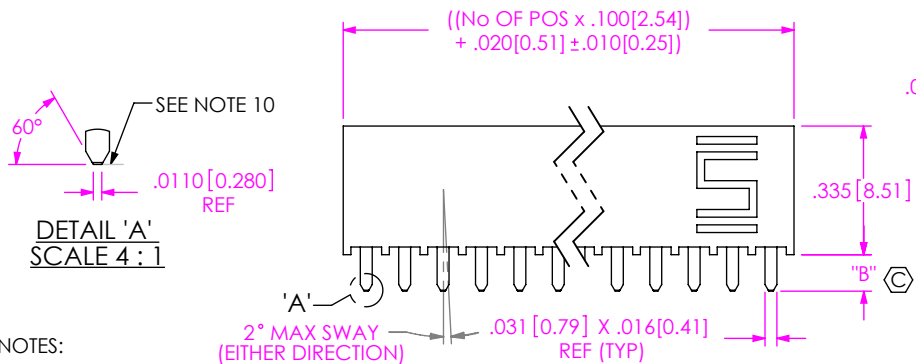

- NOTES:
- ⊙ REPRESENTS A CRITICAL DIMENSION.
  - MAXIMUM CUT FLASH: .015[0.38] WITH NO FLASH BELOW STANDOFFS OR IN CONTACT HOLES.
  - MINIMUM CONTACT PUSHOUT FORCE: 1.5 LBS
  - MAXIMUM ALLOWABLE BOW: .003[0.08] INCH/INCH
  - NOTE DELETED.
  - MAXIMUM ALLOWABLE VARIATION BETWEEN ROWS: .010[0.25]
  - "END WALLS" AFTER CUTTING SHOULD BE .020±.003 [0.51±0.08].
  - NOTCH ON -P-RA & -D-RA-N OPTIONS TO BE ORIENTED AS SHOWN.
  - SHEAR LOCATION TO BE WITHIN .001[0.03] OF THE BREAK OFF CENTER LOCATION.
  - SHEAR LOCATION TO BE WITHIN .001[0.03] OF THE BREAK OFF CENTER LOCATION FOR MACHINE FILL.
  - LEAD STYLE X2 (SINGLE AND DOUBLE) -RA's TO BE LAYER PACKAGED. ALL OTHER -RA LEAD STYLES: UNDER 5 POSITION TO BE LAYER PACKAGED, 5 AND UP TO BE PACKAGED IN TUBES.
  - ORDERS WILL BE PACKAGED ACCORDING TO THE SAMTEC PACKAGING EFFICIENCY STANDARDS (SPES) FOUND ON WWW.SAMTEC.COM

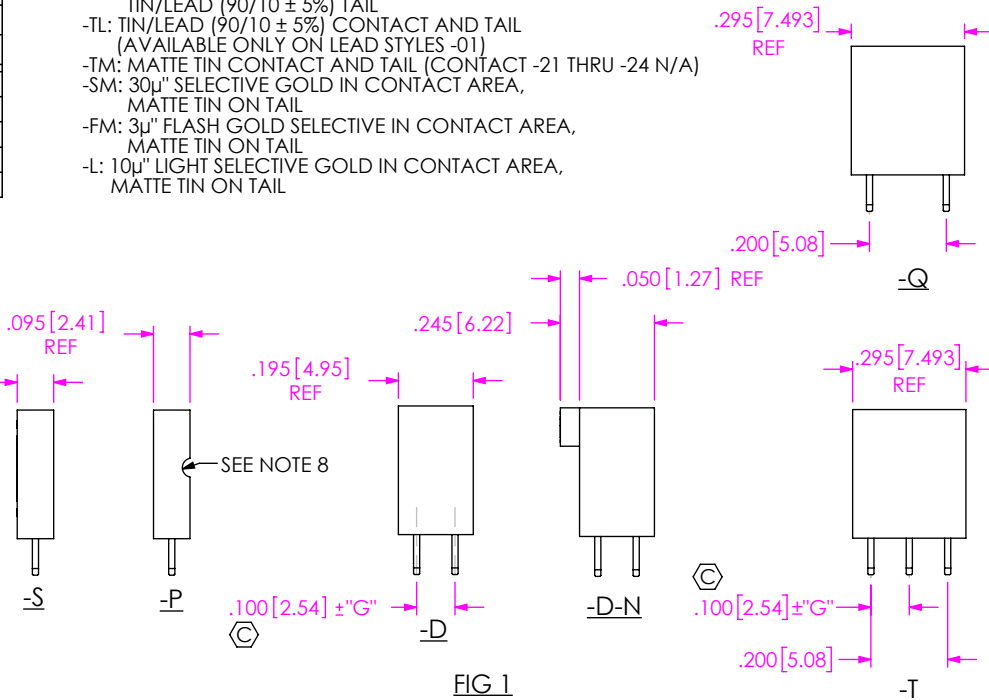

FIG 1

UNLESS OTHERWISE SPECIFIED, DIMENSIONS ARE IN INCHES. TOLERANCES ARE: DECIMALS ANGLES .XX: ±.01 [0.3] .XXX: ±.005 [0.13]	PROPRIETARY NOTE THIS DOCUMENT CONTAINS CONFIDENTIAL AND PROPRIETARY INFORMATION AND ALL DESIGN, MANUFACTURING, REPRODUCTION, USE, PATENT RIGHTS AND SALES RIGHTS ARE EXPRESSLY RESERVED BY SAMTEC, INC. THIS DOCUMENT SHALL NOT BE DISCLOSED, IN WHOLE OR PART, TO ANY UNAUTHORIZED PERSON OR ENTITY NOR REPRODUCED, TRANSFERRED OR INCORPORATED IN ANY OTHER PROJECT IN ANY MANNER WITHOUT THE EXPRESS WRITTEN CONSENT OF SAMTEC, INC.	<b>samtec</b> 520 PARK EAST BLVD, NEW ALBANY, IN 47150 PHONE: 812-944-6733 FAX: 812-948-5047 e-Mail info@SAMTEC.com code 55322
MATERIAL: DO NOT SCALE DRAWING SHEET SCALE: 2:1 INSULATOR: -S, -D, -D-N: VECTRA E130I, COLOR: BLACK UL94 V0 -P, -T: PCT, COLOR: BLACK UL94 V0 CONTACT: PHOSPHOR BRONZE, SPRING-TEMPER ALLOY S11 OR S10 (TENSILE STRENGTH 90-100 KSI) (YIELD STRENGTH @ 2% OFFSET 88-98 KSI) PER MIL (8-1250) THICKNESS: .0160±.001 [0.635±0.03]		
		DESCRIPTION: ASSEMBLY, SOCKET STRIP .016 X .031 TAIL DWG. NO. SSW-1XX-XX-XXX-X-XX-XXX-XX BY: PURVIS 06/12/1987 SHEET 1 OF 3

TABLE 3			
IN-PROCESS	"D"	"E"	"F"
SSW-1XX-X2-X-D-RA	.194 [4.93]	.394 [10.01]	-----
SSW-1XX-03-X-D-RA	.394 [10.01]	.594 [15.09]	-----
SSW-1XX-02-X-T-RA	.194 [4.93]	.394 [10.01]	.594 [15.09]

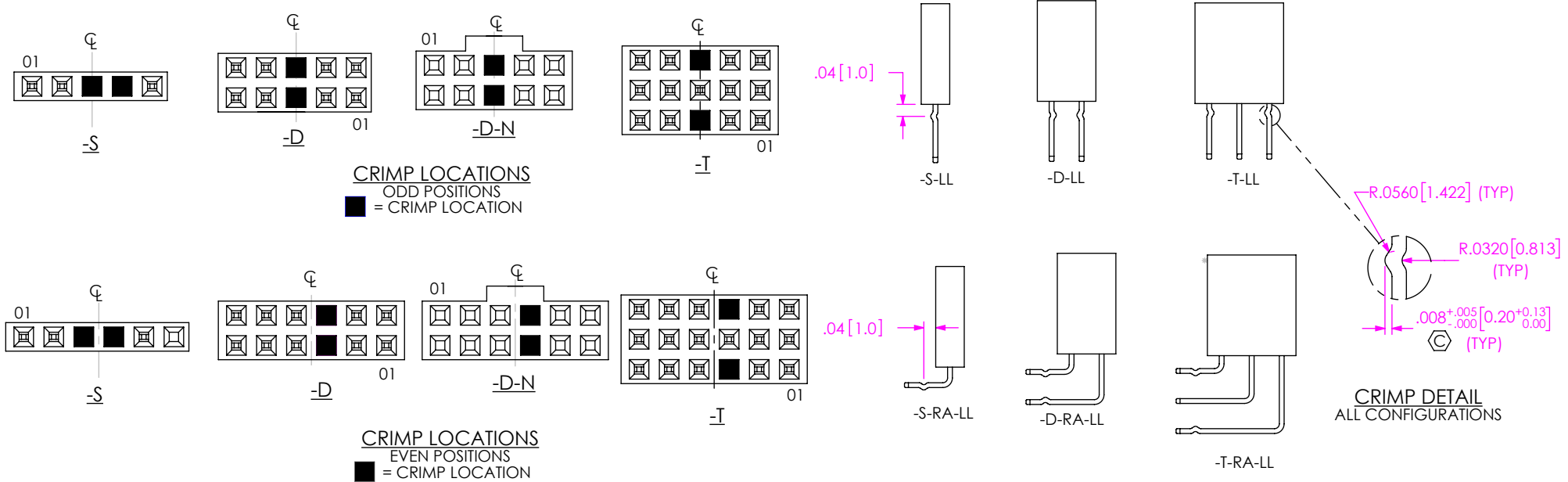
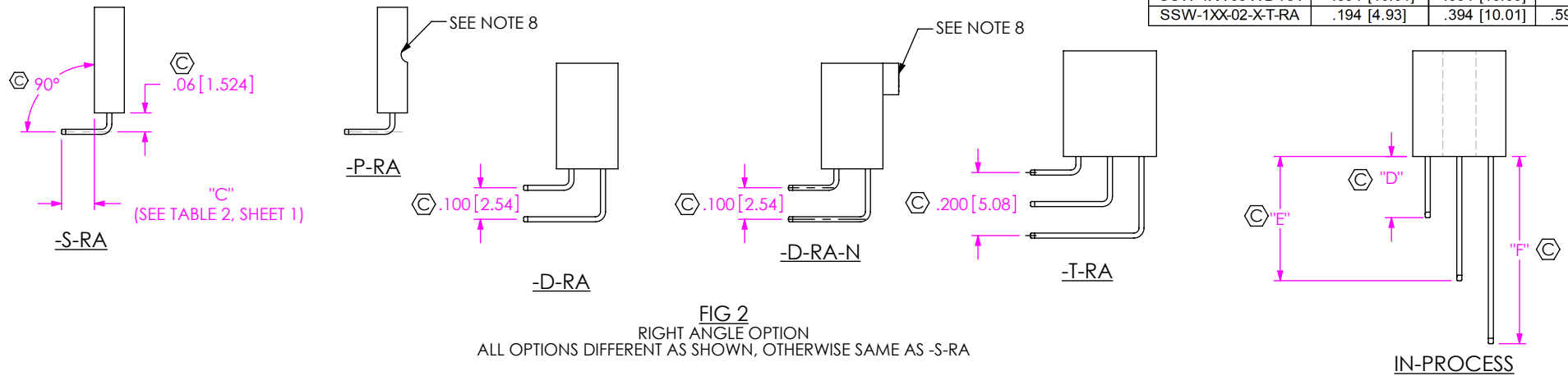

FIG 4  
LOCKING LEAD OPTION  
ALL OPTIONS SAME AS -S-XX-LL  
UNLESS OTHERWISE SHOWN

**PROPRIETARY NOTE**  
THIS DOCUMENT CONTAINS CONFIDENTIAL AND PROPRIETARY INFORMATION AND ALL DESIGN, MANUFACTURING, REPRODUCTION, USE, PATENT RIGHTS AND SALES RIGHTS ARE EXPRESSLY RESERVED BY SAMTEC, INC. THIS DOCUMENT SHALL NOT BE DISCLOSED, IN WHOLE OR PART, TO ANY UNAUTHORIZED PERSON OR ENTITY NOR REPRODUCED, TRANSFERRED OR INCORPORATED IN ANY OTHER PROJECT IN ANY MANNER WITHOUT THE EXPRESS WRITTEN CONSENT OF SAMTEC, INC.



520 PARK EAST BLVD. NEW ALBANY, IN 47150  
PHONE: 812-944-6733 FAX: 812-948-5047  
e-Mail info@SAMTEC.com code 55322

DO NOT SCALE DRAWING

SHEET SCALE: 2:1

DESCRIPTION:  
ASSEMBLY, SOCKET STRIP .016 X .031 TAIL

DWG. NO.  
SSW-1XX-XX-XXX-X-XX-XXX-XX

BY: PURVIS 06/12/1987 SHEET 2 OF 3

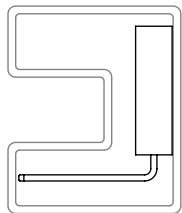

SSW-1XX-03-XXX-S-RA  
SSW-1XX-23-XXX-S-RA

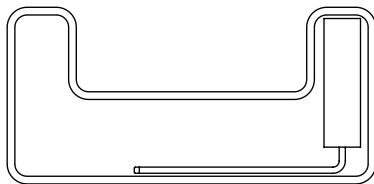

SSW-1XX-04-XXX-S-RA  
SSW-1XX-24-XXX-S-RA

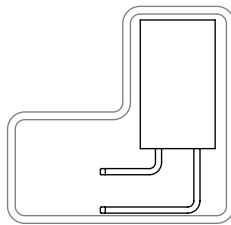

SSW-1XX-03-XXX-D-RA  
SSW-1XX-23-XXX-D-RA

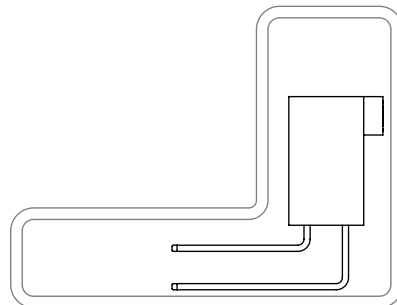

SSW-1XX-03-XXX-D-RA-N  
SSW-1XX-23-XXX-D-RA-N

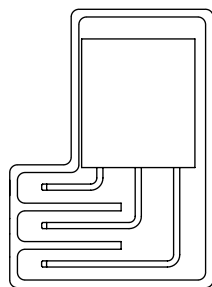

SSW-1XX-XX-XXX-T-RA  
SSW-1XX-XX-XXX-Q-RA

FIG 5  
PACKAGING VIEWS  
(SEE NOTE 11)

TABLE 5 TUBE SPECIFICATION		
PART NUMBER	TUBE	PLUG
SSW-1XX-03-XXX-S-RA SSW-1XX-23-XXX-S-RA	PT-3-24-01-01	TP-03
SSW-1XX-04-XXX-S-RA SSW-1XX-24-XXX-S-RA	PT-1-24-01-34	TP-03
SSW-1XX-03-XXX-D-RA SSW-1XX-23-XXX-D-RA	PT-1-24-06-40	TP-07
SSW-1XX-03-XXX-D-RA-N SSW-1XX-23-XXX-D-RA-N	ASP-90341-01-S	TP-07
SSW-1XX-XX-XXX-T-RA SSW-1XX-XX-XXX-Q-RA	PT-1-24-04-40	TP-07

SEE NOTE 8

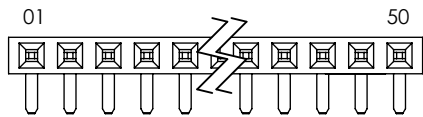

-S, -P, -S-RA & -P-RA

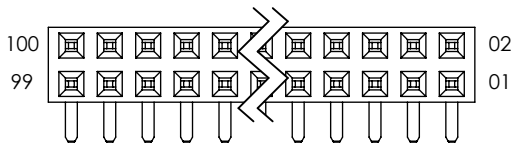

-D, -D-RA

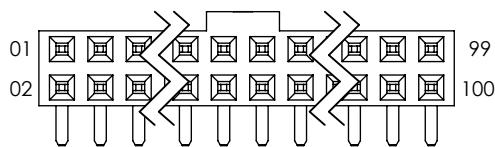

-D-N, -D-RA-N

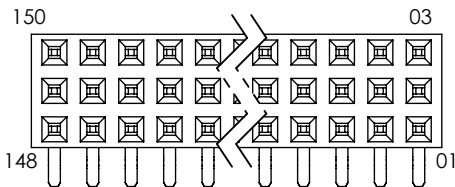

-T, -Q, -T-RA & -Q-RA

FIG 3

POLARIZATION LOCATION

(INSERT PK-15-N INTO SPECIFIED POSITION & BREAK OFF TAB)  
(-RA OPTION SHOWN FOR ORIENTATION PURPOSE ONLY)

TABLE 6	
POS PER ROW	NSW-XX-D-N-XX
5	NSW-47-D-N-05
7	NSW-47-D-N-07
8	NSW-44-D-N-08
10	NSW-43-D-N-10
12	NSW-38-D-N-12
13	NSW-41-D-N-13
15	NSW-47-D-N-15
17	NSW-35-D-N-17
20	NSW-20-D-N
25	NSW-25-D-N
32	NSW-32-D-N
36	NSW-36-D-N

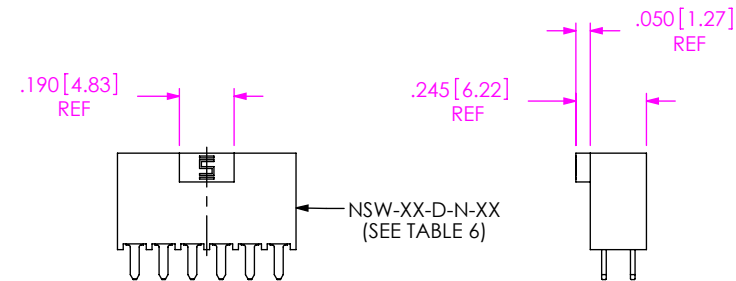

FIG 6  
NOTCH OPTION  
DIFFERENT AS SHOWN, OTHERWISE SAME AS FIG 1

**PROPRIETARY NOTE**  
THIS DOCUMENT CONTAINS CONFIDENTIAL AND PROPRIETARY INFORMATION AND ALL DESIGN, MANUFACTURING, REPRODUCTION, USE, PATENT RIGHTS AND SALES RIGHTS ARE EXPRESSLY RESERVED BY SAMTEC, INC. THIS DOCUMENT SHALL NOT BE DISCLOSED, IN WHOLE OR PART, TO ANY UNAUTHORIZED PERSON OR ENTITY NOR REPRODUCED, TRANSFERRED OR INCORPORATED IN ANY OTHER PROJECT IN ANY MANNER WITHOUT THE EXPRESS WRITTEN CONSENT OF SAMTEC, INC.

DO NOT SCALE DRAWING

SHEET SCALE: 2:1



520 PARK EAST BLVD, NEW ALBANY, IN 47150  
PHONE: 812-944-6733 FAX: 812-948-5047  
e-Mail info@SAMTEC.com code 55322

DESCRIPTION:  
ASSEMBLY, SOCKET STRIP .016 X .031 TAIL

DWG. NO.  
SSW-1XX-XX-XXX-X-XX-XXX-XX

BY: PURVIS 06/12/1987 SHEET 3 OF 3