

DO NOT SCALE FROM THIS PRINT

TABLE 1		
LEAD STYLE	"A"	CONTACT
-01	0.090 [2.29]	C-79-01-X
-01-S-RA	N/A	C-79-53-X
-01-D-RA	N/A	C-79-53-X C-79-12-X
-01-T-RA	N/A	C-79-53-X C-79-12-X C-79-12-X
-02	0.600 [15.24]	C-79-02-X
-03	0.208 [5.28]	C-79-53-X

SQT-1XX-XX-XXX-X-XXX-XXX

No OF POSITIONS

-02 THRU -50  
(PER ROW)  
-01 (SEE NOTE 3)

LEAD STYLE  
(SEE TABLE 1)

PLATING SPECIFICATION

- F: 3µ" SELECTIVE GOLD IN CONTACT AREA, MATTE TIN ON TAIL.
- L: 10µ" SELECTIVE GOLD IN CONTACT AREA, MATTE TIN ON TAIL.
- G: 20µ" SELECTIVE GOLD IN CONTACT AREA, 3µ" SELECTIVE GOLD ON TAIL.
- S: 30µ" SELECTIVE GOLD IN CONTACT AREA, MATTE TIN ON TAIL.
- H: 50µ" SELECTIVE GOLD IN CONTACT AREA, 3µ" SELECTIVE GOLD ON TAIL.
- FM: 3µ" SELECTIVE GOLD IN CONTACT AREA, MATTE TIN ON TAIL.
- LM: 10µ" SELECTIVE GOLD IN CONTACT AREA, MATTE TIN ON TAIL.
- SM: 30µ" SELECTIVE GOLD IN CONTACT AREA, MATTE TIN ON TAIL.
- STL: 30µ" SELECTIVE GOLD IN CONTACT AREA, SnPb ON TAIL.

POLARIZATION OPTION

-XXX: INDICATES POSITION  
(SEE NOTE 10)

OPTION

- RA: RIGHT ANGLE  
(-01 LEAD STYLE, ROWS -S, -D, -T ONLY)  
(NOT AVAILABLE ON -Q, -5 & -6 ROWS)  
(SINGLE, DOUBLE, TRIPLE ROW: SEE FIG 2, SHT 2)
- \*-SD1: SOLDER DONUT (SEE FIG 3, SHT 2)  
(AVAILABLE ON -S, -D, -T ONLY)
- \*\* -MW: METAL WASHER (SHT 2, SEE FIG 4)  
(AVAILABLE ON LEAD STYLES -01 & -03 ONLY)  
(5 POS MIN, 30 POS MAX, .300 MAX TAIL)

ROW SPECIFICATION

- S: SINGLE (USE SQT-61-S)
- D: DOUBLE (USE SQT-62-D)
- T: TRIPLE (USE SQT-62-T)
- Q: QUAD (USE SQT-62-Q)
- 5: FIVE ROW (USE SQT-62-5)
- 6: SIX ROW (USE SQT-62-6)

\* = NOT RELEASED FOR PRODUCTION  
\*\* = MW OPTION, DO NOT DESIGN IN, SAMTEC WILL ONLY SUPPORT EXISTING BUSINESS 02/06/2002

\* NOT RELEASED

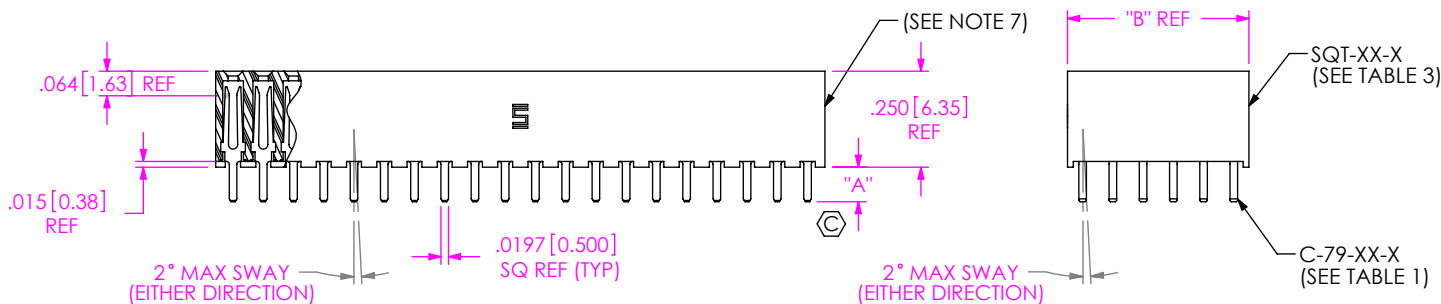
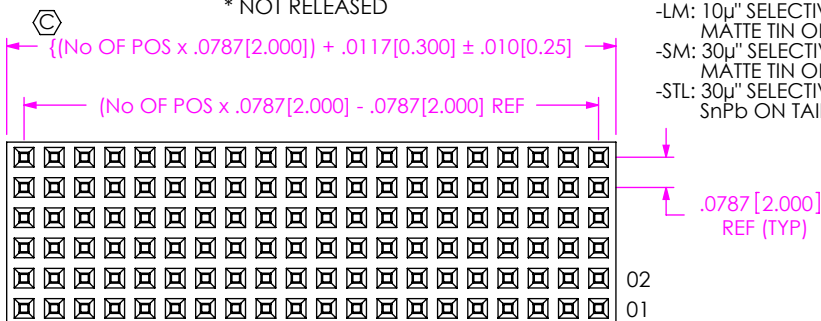
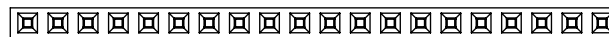

FIG 1  
SQT-120-01-XX-6 SHOWN

TABLE 3		
ROW SPEC.	BODY	"B"
-S	SQT-61-S	0.0787 [2.000]
-D	SQT-62-D	0.1575 [4.000]
-T	SQT-62-T	0.2362 [6.000]
-Q	SQT-62-Q	0.3150 [8.000]
-5	SQT-62-5	0.3937 [10.000]
-6	SQT-62-6	0.4724 [12.000]

NOTES:

- ⊕ REPRESENTS A CRITICAL DIMENSION.
- MINIMUM CONTACT RETENTION: .5 LB
- 01 POSITION OFFERED FOR SINGLE ROW & ONLY FOR -S, -D, & -T ROWS RIGHT ANGLE ONLY.
- 01, -02, & -03 & ONLY FOR -S, -D, & -T ROWS POSITIONS TO BE LAYER PACKAGED.
- STOCK 62 POSITION FOR -D AND 61 POSITION FOR -S, -01 LEAD STYLE ONLY. TO BE CUT TO POSITION FOR CUSTOMER.
- MAXIMUM BURR: .005[0.13]
- ENDWALL AFTER CUTTING: .033[0.84]±.004[0.10], VOIDS MAY BE PRESENT. CONTACTS MUST NOT BE VISIBLE THROUGH THE ENDWALL.
- MAXIMUM CUT FLASH: .020[0.50]
- MAXIMUM HEIGHT VARIATION: .005[0.13]
- INSERT PK-07-N INTO SPECIFIED POSITION AND BREAK OFF TAB.



01 02

(POSITION PATTERN SINGLE ROW ONLY)

UNLESS OTHERWISE SPECIFIED, DIMENSIONS ARE IN INCHES.

TOLERANCES ARE:

DECIMALS ANGLES  
.XX: ±.01 [.3] 2°  
.XXX: ±.005 [.13]  
.XXXX: ±.0020 [.051]

PROPRIETARY NOTE

THIS DOCUMENT CONTAINS CONFIDENTIAL AND PROPRIETARY INFORMATION AND ALL DESIGN, MANUFACTURING, REPRODUCTION, USE, PATENT RIGHTS AND SALES RIGHTS ARE EXPRESSLY RESERVED BY SAMTEC, INC. THIS DOCUMENT SHALL NOT BE DISCLOSED, IN WHOLE OR PART, TO ANY UNAUTHORIZED PERSON OR ENTITY NOR REPRODUCED, TRANSFERRED OR INCORPORATED IN ANY OTHER PROJECT IN ANY MANNER WITHOUT THE EXPRESS WRITTEN CONSENT OF SAMTEC, INC.



520 PARK EAST BLVD., NEW ALBANY, IN 47150  
PHONE: 812-944-6733 FAX: 812-948-5047  
e-Mail: info@SAMTEC.com code 55322

MATERIAL: DO NOT SCALE DRAWING SHEET SCALE: 2:1

INSULATOR: LCP, UL 94 VO, COLOR: BLACK  
CONTACT: PHOS BRONZE

MAX BOW ALLOWED: .004[.10] IN/IN

DESCRIPTION:

2MM SOCKET STRIP ASSEMBLY

DWG. NO.

SQT-1XX-XX-XXX-X-XXX-XXX

BY: BRATCHER 07/24/1995

SHEET 1 OF 3

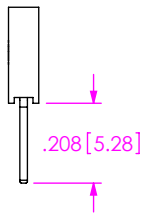

IN PROCESS 1  
(LEAD STYLE -01-S,D,T-RA)

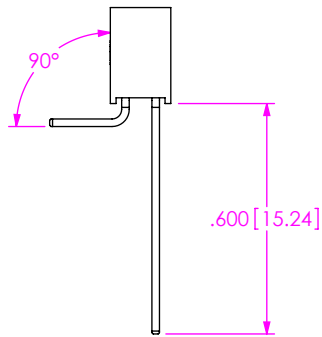

IN PROCESS 2  
(LEAD STYLE -01-D,T-RA)

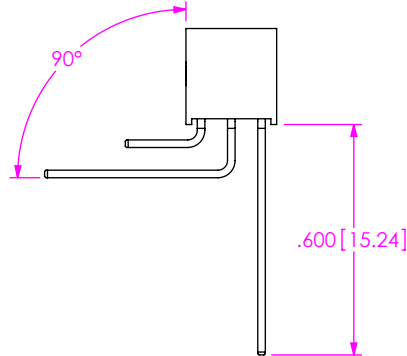

IN PROCESS 3  
(LEAD STYLE -01-T-RA)

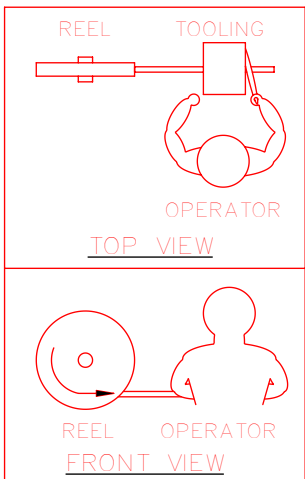

WASHER REEL ASSEMBLY  
ORIENTATION VIEW

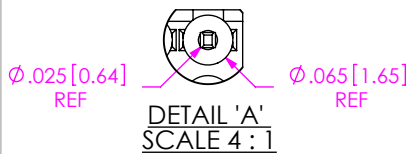
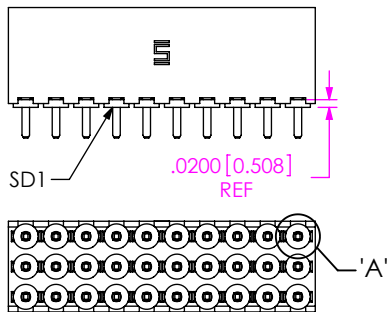

FIG 3  
\*SD1: SOLDER DONUT  
(ONE PER POSITION)  
(ROW STYLE -S,-D,-T & -Q ONLY)  
\*NOT ENGINEERING APPROVED

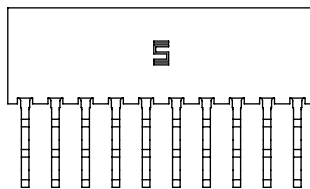
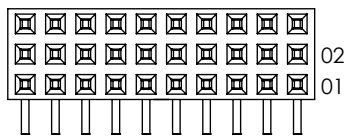
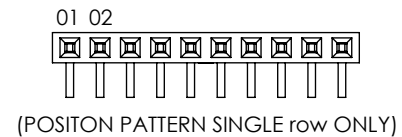

FIG 2  
-RA: RIGHT ANGLE  
(LEAD STYLE -01-D,T)



(POSITION PATTERN SINGLE row ONLY)

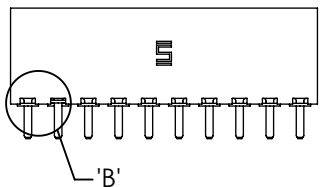
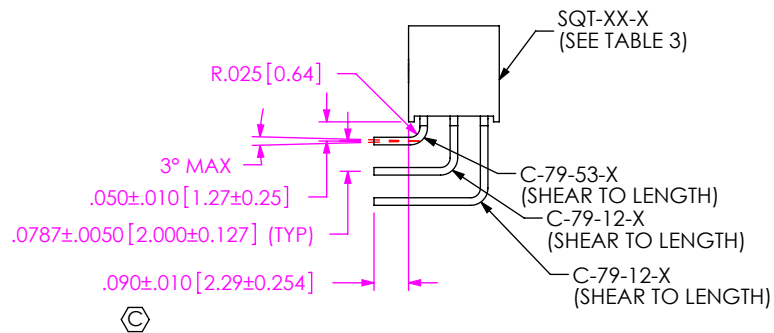
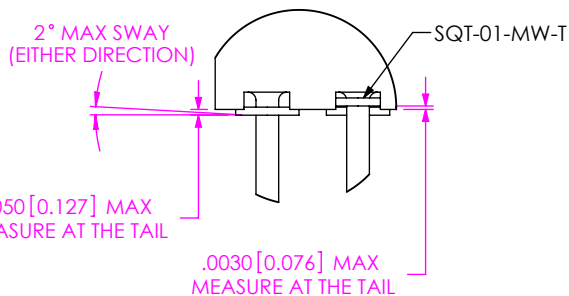

FIG 4  
\*\*-MW: METAL WASHER  
(ONE PER POSITION)  
(AVAILABLE ON LEADSTYLES -01 & -03 ONLY  
(5 POS MIN, 30 POS MAX)  
\*\*-MW OPION, DO NOT DESIGN IN. SAMTEC WILL  
ONLY SUPPORT EXISTING BUSINESS 2/06/02.



DETAIL 'B'  
SCALE 6:1

**PROPRIETARY NOTE**  
THIS DOCUMENT CONTAINS CONFIDENTIAL AND PROPRIETARY INFORMATION AND ALL DESIGN, MANUFACTURING, REPRODUCTION, USE, PATENT RIGHTS AND SALES RIGHTS ARE EXPRESSLY RESERVED BY SAMTEC, INC. THIS DOCUMENT SHALL NOT BE DISCLOSED, IN WHOLE OR PART, TO ANY UNAUTHORIZED PERSON OR ENTITY NOR REPRODUCED, TRANSFERRED OR INCORPORATED IN ANY OTHER PROJECT IN ANY MANNER WITHOUT THE EXPRESS WRITTEN CONSENT OF SAMTEC, INC.

DO NOT SCALE DRAWING  
SHEET SCALE: 2:1



520 PARK EAST BLVD, NEW ALBANY, IN 47150  
PHONE: 812-944-6733 FAX: 812-948-5047  
e-Mail info@SAMTEC.com code 55322

DESCRIPTION:  
2MM SOCKET STRIP ASSEMBLY  
DWG. NO.  
**SQT-1XX-XX-XXX-X-XXX-XXX**  
BY: BRATCHER 07/24/1995 SHEET 2 OF 3

PACKAGING VIEWS

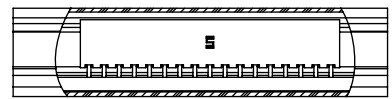

SQT-1XX-01-XX-D  
(SEE TABLE 2)

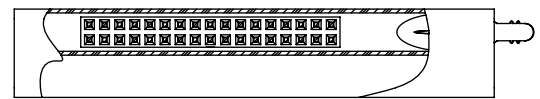

SQT-1XX-02-XX-D  
(LOCATE PLUG AS SHOWN)  
(SEE TABLE 2)

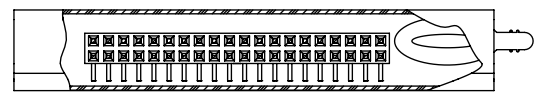

SQT-1XX-01-XX-D-RA SHOWN  
(LOCATE PLUG AS SHOWN)  
(SEE TABLE 2)

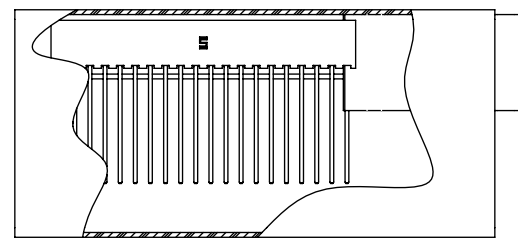
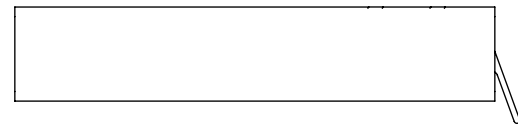
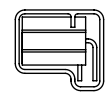

SQT-1XX-05-XX-X  
(LOCATE PLUG AS SHOWN)  
(SEE TABLE 2)

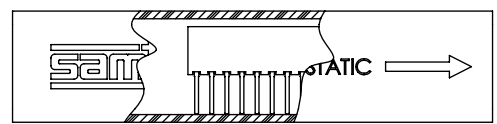
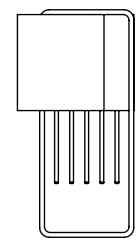

SQT-1XX-03-XX-6 SHOWN  
(SEE TABLE 2)

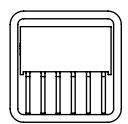
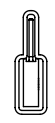
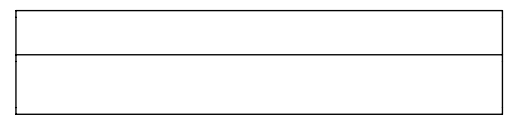

TABLE 2			
ROW SPEC.	No. OF POS	PKG TUBE	TUBE PLUG
-03-S	04-50	PT-SQT001	TP-12
-02-S	04-50	PT-1-24-10-03	TP-03
-01-S-RA	04-50	PT-1-24-01-43	TP-24
-01-D	04-50	PT-1-24-02-17	TP-09
-02-D	04-50	PT-1-24-01-34	TP-07
-03-D	04-50	PT-1-24-01-22	TP-03
-01-D-RA	04-50	PT-1-24-01-45	TP-03
-01-T	04-50	PT-1-24-05-09	TP-07
-02-T	04-50	PT-1-24-01-102	TP-07
-03-T	04-50	PT-1-24-08-15	TP-07
-01-Q	04-50	PT-1-24-15-29	TP-07
-02-Q	04-50	PT-1-24-02-51	TP-13
-03-Q	04-50	PT-1-24-16-29	TP-07
-01-T-RA	04-50	PT-1-24-06-40	TP-07
-01-S	04-50	PT-1-24-05-15	TP-24
-03-5	15-50	PT-1-24-01-08	TP-13
-02-5	15-50	PT-1-24-01-56	TP-31
-01-6	ALL	PT-1-24-01-52	TP-07
-02-6	ALL	PT-1-24-02-74	TP-25
-03-6	ALL	PT-1-24-01-08	TP-13
-01-5	15-50	PT-1-24-09F-109	TP-07
-01-5, -02-5, -03-5	-02 THRU -14	LAYER PACKAGING	
-S, -D, -T, -Q	-02 & -03	LAYER PACKAGING	



SQT-1XX-03-XX-S SHOWN  
(SEE TABLE 2)

**PROPRIETARY NOTE**  
THIS DOCUMENT CONTAINS CONFIDENTIAL AND PROPRIETARY INFORMATION AND ALL DESIGN, MANUFACTURING, REPRODUCTION, USE, PATENT RIGHTS AND SALES RIGHTS ARE EXPRESSLY RESERVED BY SAMTEC, INC. THIS DOCUMENT SHALL NOT BE DISCLOSED, IN WHOLE OR PART, TO ANY UNAUTHORIZED PERSON OR ENTITY NOR REPRODUCED, TRANSFERRED OR INCORPORATED IN ANY OTHER PROJECT IN ANY MANNER WITHOUT THE EXPRESS WRITTEN CONSENT OF SAMTEC, INC.

DO NOT SCALE DRAWING

SHEET SCALE: 1:1



DESCRIPTION:  
2MM SOCKET STRIP ASSEMBLY

DWG. NO.  
**SQT-1XX-XX-XXX-X-XXX-XXX**

BY: BRATCHER 07/24/1995 SHEET 3 OF 3