

**DATA SHEET**

# SKYA21012: 20 MHz to 6.0 GHz GaAs SPDT Switch

## Automotive Applications

- Infotainment
- Automated toll systems
- Garage door opener
- 802.11 b/g/n WLAN, Bluetooth® systems
- Wireless control systems
- Outdoor lighting control
- Remote keyless entry
- Telematics
- GPS/Navigation

## Features

- Positive voltage control (0 and 1.8 V to 0 and 5.0 V)
- Broadband frequency range: 20 MHz to 6.0 GHz
- Very low insertion loss, 0.35 dB typical @ 2.45 GHz
- High isolation, 24 dB typical @ 2.45 GHz
- Excellent linearity performance, IP0.5 dB = +30 dBm
- Ultra-miniature, MLPD (6-pin, 1 x 1 mm) package
- JEDEC (JESD22) qualified at 25 °C
- Lead (Pb)-free and RoHS-compliant (MSL1 @ 260 °C per JEDEC J-STD-020)



Skyworks Green™ products are compliant with all applicable legislation and are halogen-free. For additional information, refer to *Skyworks Definition of Green™*, document number SQ04-0074.

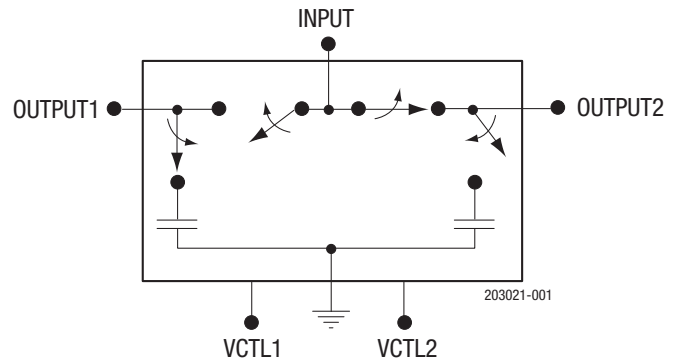

**Figure 1. SKYA21012 Block Diagram**

## Description

The SKYA21012 is a pHEMT GaAs FET I/C switch. The switch may be used in transmit/receive applications by connecting the RF common port (INPUT, pin 5) to either the OUTPUT1 or OUTPUT2 port (pin 1 or 3, respectively) using a low loss path (i.e., a positive voltage applied to either VCTL1 or VCTL2 pins). The switch is “reflective short” on the isolated port.

The switch is manufactured in a compact, 1 x 1 mm, 6-pin exposed pad plastic Micro Leadframe Package Dual (MLPD) package.

A functional block diagram is shown in Figure 1. The pin configuration and package are shown in Figure 2. Signal pin assignments and functional pin descriptions are provided in Table 1.

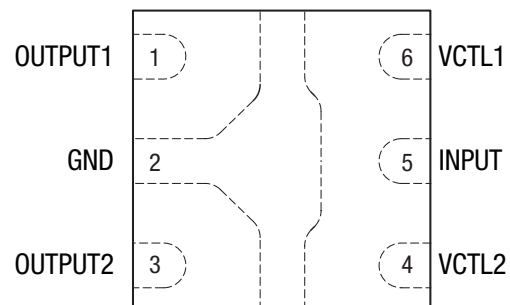

S1482

**Figure 2. SKYA21012 Pinout (Top View)**

**Table 1. SKYA21012 Signal Descriptions**

| Pin | Name    | Description                  | Pin | Name  | Description                  |
|-----|---------|------------------------------|-----|-------|------------------------------|
| 1   | OUTPUT1 | RF port. Must be DC blocked. | 4   | VCTL2 | DC control voltage           |
| 2   | GND     | Ground                       | 5   | INPUT | RF port. Must be DC blocked. |
| 3   | OUTPUT2 | RF port. Must be DC blocked. | 6   | VCTL1 | DC control voltage           |

**Table 2. SKYA21012 Absolute Maximum Ratings<sup>1</sup>**

| Parameter   | Symbol           | Minimum | Maximum                  | Units                    |
|---|------------------|---------|--------------------------|--------------------------|
| Input power<br>>500 MHz, 5 V, CW<br>>500 MHz, 2.7 V, CW<br>802.11g, 54 Mbps, 64 QAM, 2.4-2.5 GHz<br>802.11g, 54 Mbps, 64 QAM, 5.2-5.8 GHz | P <sub>IN</sub>  |         | +32<br>+31<br>+26<br>+25 | dBm<br>dBm<br>dBm<br>dBm |
| Storage temperature   | T <sub>STG</sub> | -65     | +150                     | °C                       |
| Operating temperature   | T <sub>OP</sub>  | -40     | +85                      | °C                       |

<sup>1</sup> Exposure to maximum rating conditions for extended periods may reduce device reliability. There is no damage to device with only one parameter set at the limit and all other parameters set at or below their nominal value. Exceeding any of the limits listed here may result in permanent damage to the device.

**ESD HANDLING:** Although this device is designed to be as robust as possible, electrostatic discharge (ESD) can damage this device. This device must be protected at all times from ESD when handling or transporting. Static charges may easily produce potentials of several kilovolts on the human body or equipment, which can discharge without detection. Industry-standard ESD handling precautions should be used at all times.

**Table 3. SKYA21012 Recommended Operating Conditions**

| Parameter                       | Symbol                                   | Min      | Typ | Max        | Units  |
|---------------------------------|--|----------|-----|------------|--------|
| Frequency                       | f  | 0.02     |     | 6.0        | GHz    |
| Control voltage:<br>low<br>high | V <sub>CTL_L</sub><br>V <sub>CTL_H</sub> | 0<br>1.8 |     | 0.2<br>5.0 | V<br>V |
| Operating temperature           | T <sub>OP</sub>                          |          | +25 |            | °C     |

## Electrical and Mechanical Specifications

The absolute maximum ratings of the SKYA21012 are provided in Table 2. The recommended operating conditions are specified in Table 3 and electrical specifications are provided in Table 4.

Typical performance characteristics of the SKYA21012 are illustrated in Figures 3 through 9.

The state of the SKYA21012 is determined by the logic provided in Table 5.

**Table 4. SKYA21012 Electrical Specifications<sup>1</sup>**

**(V<sub>CTL</sub> = 0 V and +2.7 V, T<sub>OP</sub> = +25 °C, P<sub>IN</sub> = 0 dBm, Characteristic Impedance [Z<sub>0</sub>] = 50 Ω, Unless Otherwise Noted)**

| Parameter                                    | Symbol             | Test Condition   | Min      | Typ          | Max          | Units    |
|--|--------------------|--|----------|--------------|--------------|----------|
| Frequency                                    | f                  |  | 0.02     |              | 6.0          | GHz      |
| Insertion loss                               | IL                 | 0.02-3.0 GHz<br>3.0-6.0 GHz  |          | 0.35<br>0.50 | 0.50<br>0.65 | dB<br>dB |
| Isolation                                    | Iso                | 0.02-3.0 GHz<br>3.0-6.0 GHz  | 22<br>22 | 24<br>26     |              | dB<br>dB |
| Return loss (insertion loss state)           |                    | 0.02-3.0 GHz<br>3.0-6.0 GHz  |          | 25<br>15     |              | dB<br>dB |
| Switching characteristics:<br>Rise/fall time |                    | 10/90% or 90/10% RF  |          | 40           |              | ns       |
| On/off time                                  |                    | 50% V <sub>CTL</sub> to 90/10% RF  |          | 100          |              | ns       |
| Video feed-through                           |                    |  |          | 25           |              | mV       |
| 0.5 dB input compression point               | IPO.5dB            | V <sub>CTL</sub> = 0 and 1.8 V<br>@ 2.45 GHz                                   | +21      | +22          |              | dBm      |
|  |                    | V <sub>CTL</sub> = 0 and 2.7 V<br>@ 2.45 GHz                                   | +29      | +30          |              | dBm      |
|  |                    | V <sub>CTL</sub> = 0 and 2.7 V<br>@ 48 MHz                                     |          | +26          |              | dBm      |
| Input IP3                                    | IIP3               | P <sub>IN</sub> = +20 dBm/tone<br>V <sub>CTL</sub> = 0 and 1.8 V<br>@ 2.45 GHz | +30      | +32          |              | dBm      |
|  |                    | V <sub>CTL</sub> = 0 and 2.7 V<br>@ 2.45 GHz                                   | +46      | +50          |              | dBm      |
|  |                    | V <sub>CTL</sub> = 1.8 V @ 5.8 GHz   |          | +30          |              | dBm      |
|  |                    | V <sub>CTL</sub> = 2.7 V @ 5.8 GHz   |          | +46          |              | dBm      |
| Error vector magnitude                       | EVM                | 802.11a, 54 Mbps,<br>P <sub>IN</sub> = <+24 dBm,<br>V <sub>CTL</sub> = 2.7 V   |          | 2.5          |              | %        |
|  |                    | 802.11g, 54 Mbps,<br>P <sub>IN</sub> = <+25.5 dBm,<br>V <sub>CTL</sub> = 2.7 V |          | 2.5          |              | %        |
| Control voltage:<br>Low                      | V <sub>CTL_L</sub> |  | 0        |              | 0.2          | V        |
| High   | V <sub>CTL_H</sub> |  | 1.8      | 2.7          | 5.0          | V        |
| Supply current                               | I <sub>CC</sub>    | V <sub>CTL_L</sub> = 0 V   |          | 5            |              | μA       |
|  |                    | V <sub>CTL_H</sub> = 5 V   |          | 5            |              | μA       |

<sup>1</sup> Performance is guaranteed only under the conditions listed in this Table.

### Typical Performance Characteristics

( $V_{CTL} = 0\text{ V}$  and  $+2.7\text{ V}$ ,  $T_{OP} = +25\text{ }^{\circ}\text{C}$ ,  $P_{IN} = 0\text{ dBm}$ , Characteristic Impedance [ $Z_0$ ] =  $50\ \Omega$ , Blocking Capacitors =  $100\text{ pF}$ , Bypass Capacitors =  $33\text{ pF}$ , Unless Otherwise Noted)

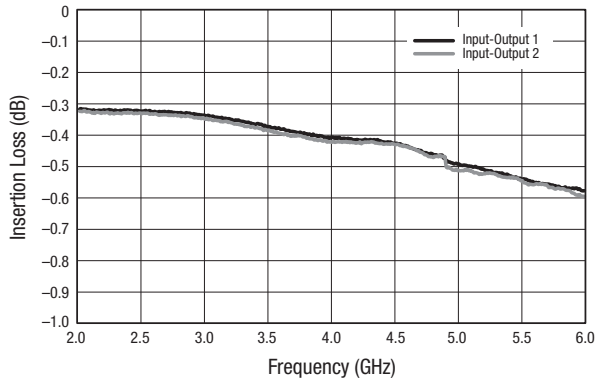

Figure 3. Typical Insertion Loss

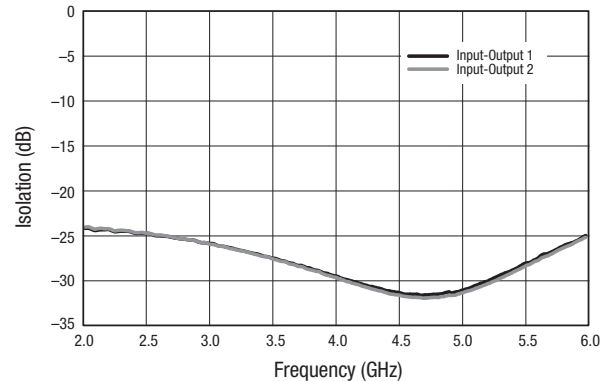

Figure 4. Typical Isolation

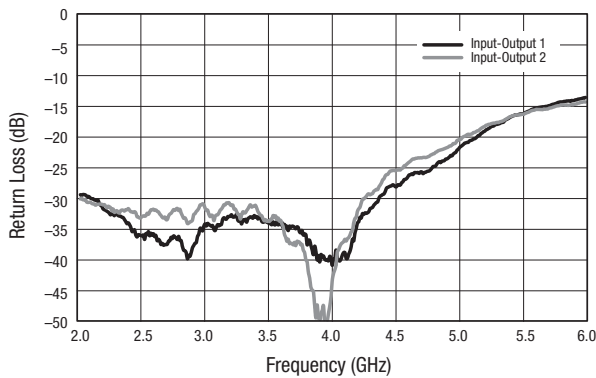

Figure 5. Typical Return Loss

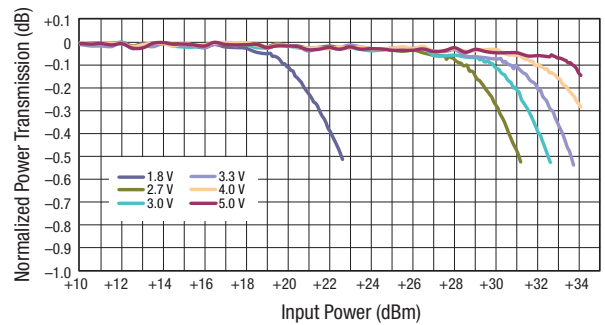

Figure 6. Compression vs Control Voltage (2450 MHz)

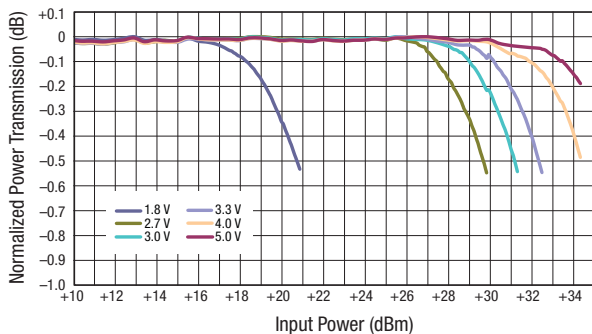

Figure 7. Compression vs Control Voltage (5.2 to 5.8 GHz)

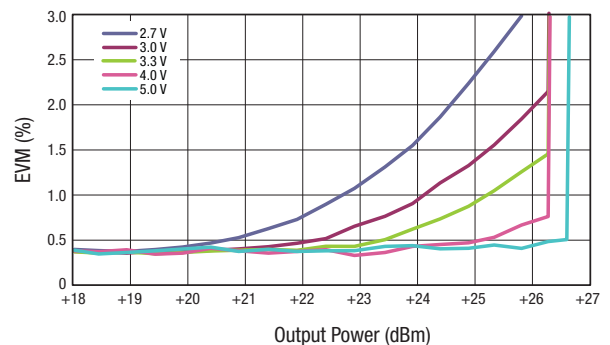

Figure 8. 802.11g EVM vs Output Power @ 2.45 GHz, 54 Mbps

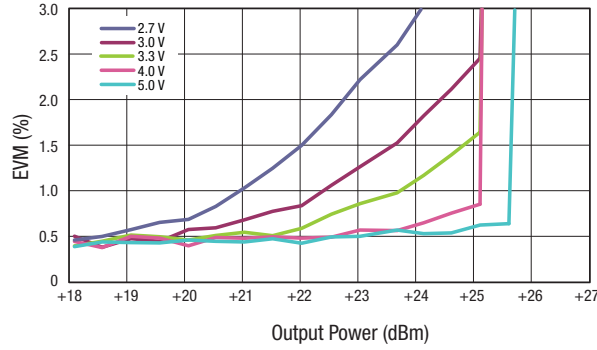

Figure 9. 802.11a EVM vs Output Power, 5.2 to 5.8 GHz, 54 Mbps

Table 5. SKYA21012 Truth Table<sup>1</sup>

| VCTL1 (Pin 6) | VCTL2 (Pin 4) | INPUT to OUTPUT1 Path | INPUT to OUTPUT2 Path |
|---------------|---------------|-----------------------|-----------------------|
| 1             | 0             | Isolation             | Insertion loss        |
| 0             | 1             | Insertion loss        | Isolation             |

<sup>1</sup> "1" = +1.8 V to +5 V. "0" = 0 V to +0.2 V.  
 Any state other than described in this Table places the switch into an undefined state.  
 An undefined state will not damage the device.

### Evaluation Board Description

The SKYA21012 Evaluation Board is used to test the performance of the SKYA21012 SPDT Switch. An Evaluation Board schematic diagram is provided in Figure 10. An assembly drawing for the Evaluation Board is shown in Figure 11.

### Package Dimensions

The PCB layout footprint for the SKYA21012 is provided in Figure 12. Typical part markings are shown in Figure 13. Package dimensions are shown in Figure 14, and tape and reel dimensions are provided in Figure 15.

### Package and Handling Information

Instructions on the shipping container label regarding exposure to moisture after the container seal is broken must be followed. Otherwise, problems related to moisture absorption may occur when the part is subjected to high temperature during solder assembly.

The SKYA21012 is rated to Moisture Sensitivity Level 1 (MSL1) at 260 °C. It can be used for lead or lead-free soldering. For additional information, refer to the Skyworks Application Note, *Solder Reflow Information*, document number 200164.

Care must be taken when attaching this product, whether it is done manually or in a production solder reflow environment. Production quantities of this product are shipped in a standard tape and reel format.

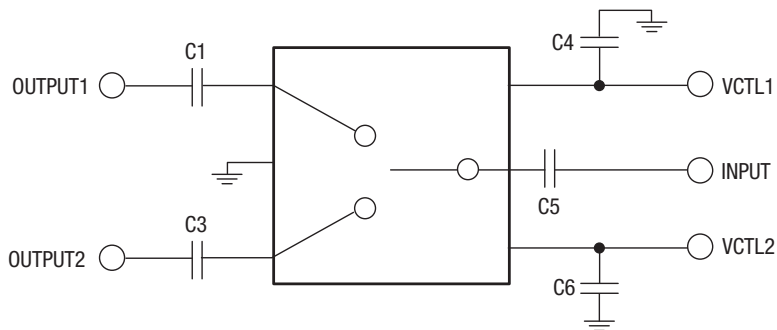

C1, C3, and C5 are DC blocking capacitors (100 pF)  
C4 and C6 are bypass capacitors (33 pF)

Use 10 nF DC blocking capacitors (C1, C3, and C5)  
for <50 MHz operation.

S1496

Figure 10. SKYA21012 Evaluation Board Schematic

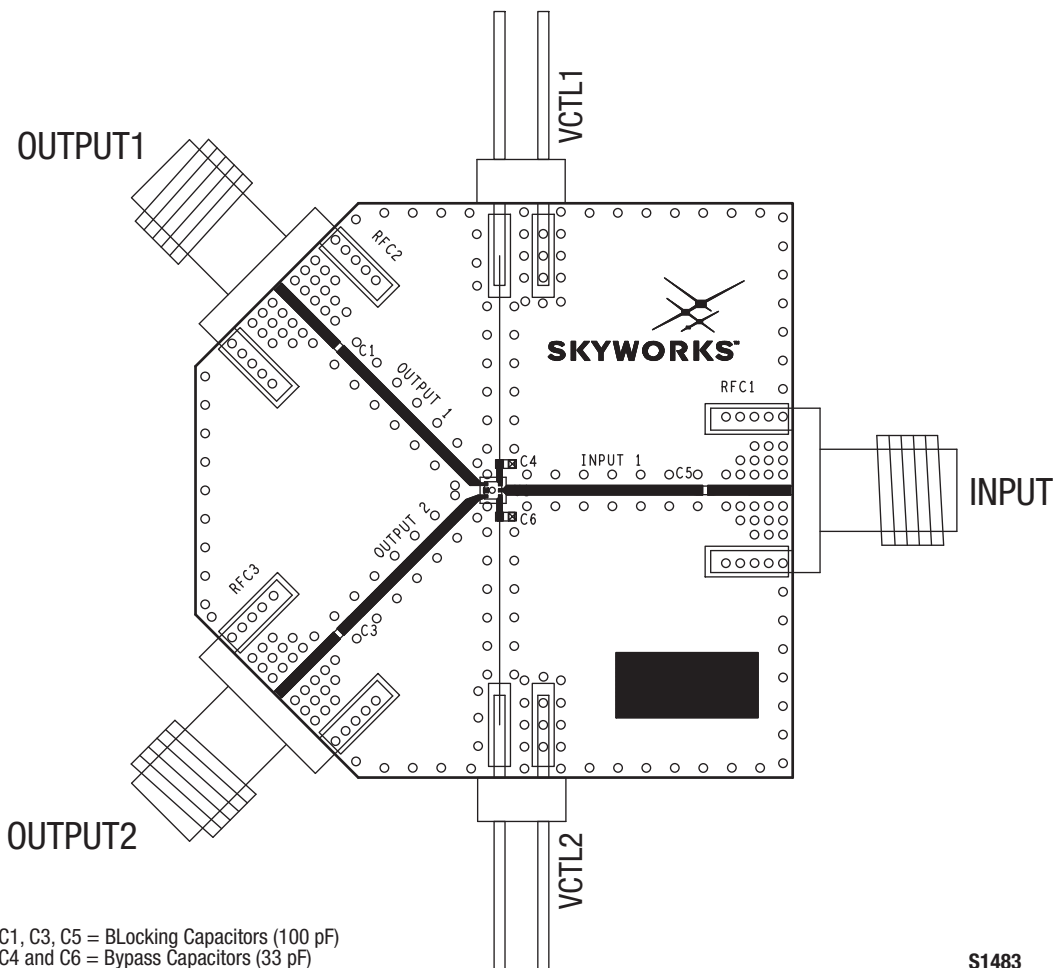

C1, C3, C5 = Blocking Capacitors (100 pF)  
C4 and C6 = Bypass Capacitors (33 pF)

S1483

Figure 11. SKYA21012 Evaluation Board Assembly Diagram

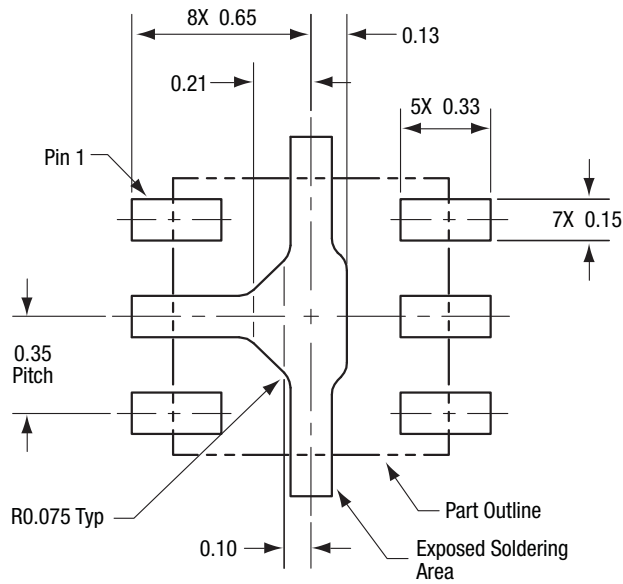

All measurements in millimeters

S1484

**Figure 12. SKYA21012 PCB Layout Footprint (Top View)**

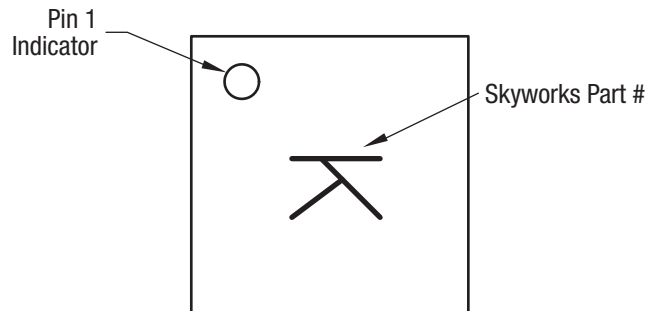

**Figure 13. Typical Part Markings (Top View)**

**DATA SHEET • SKYA21012: 20 MHz TO 6.0 GHz GaAs SPDT SWITCH**

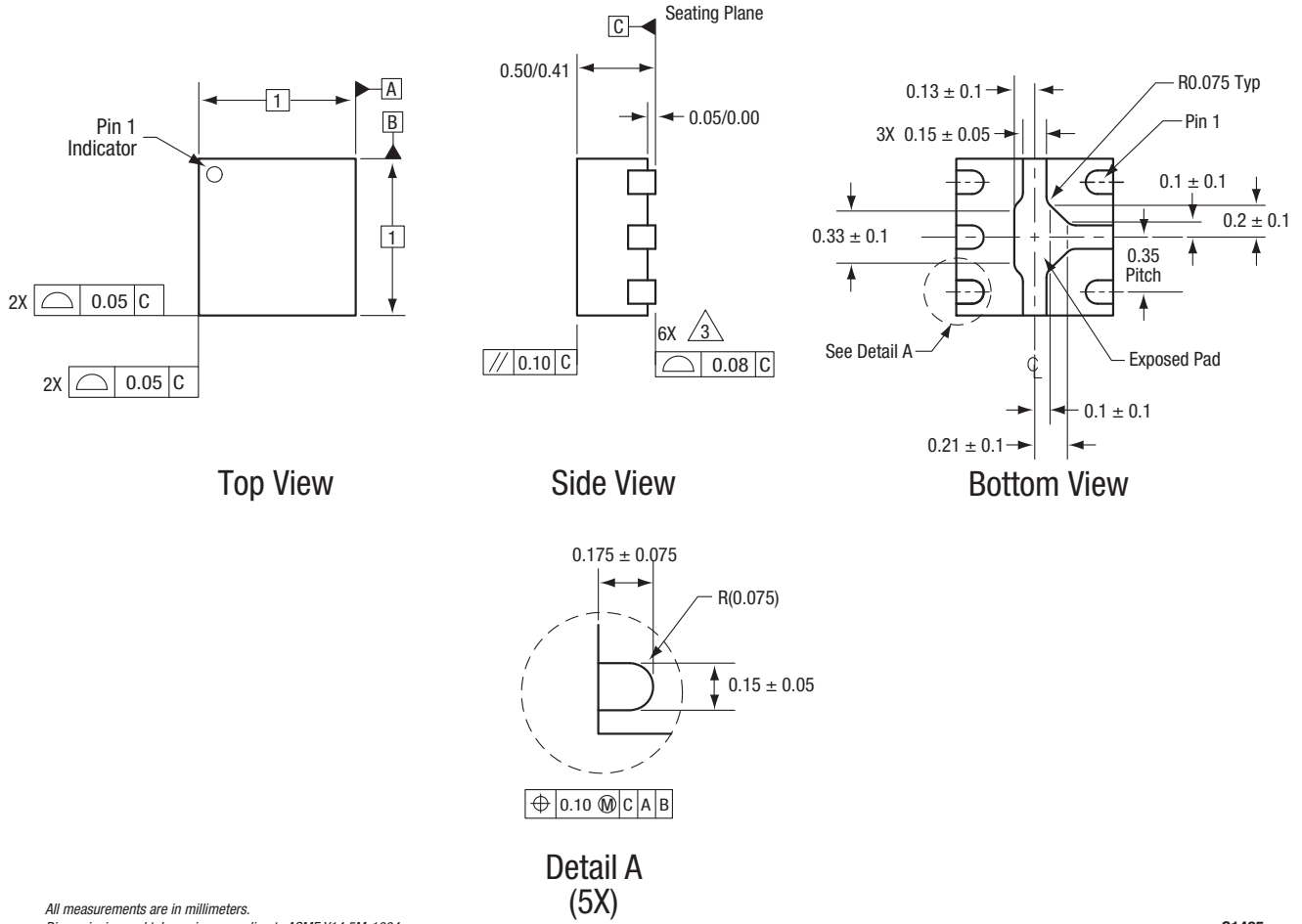

All measurements are in millimeters.  
Dimensioning and tolerancing according to ASME Y14.5M-1994.

S1485

**Figure 14. SKYA21012 Package Dimensions**



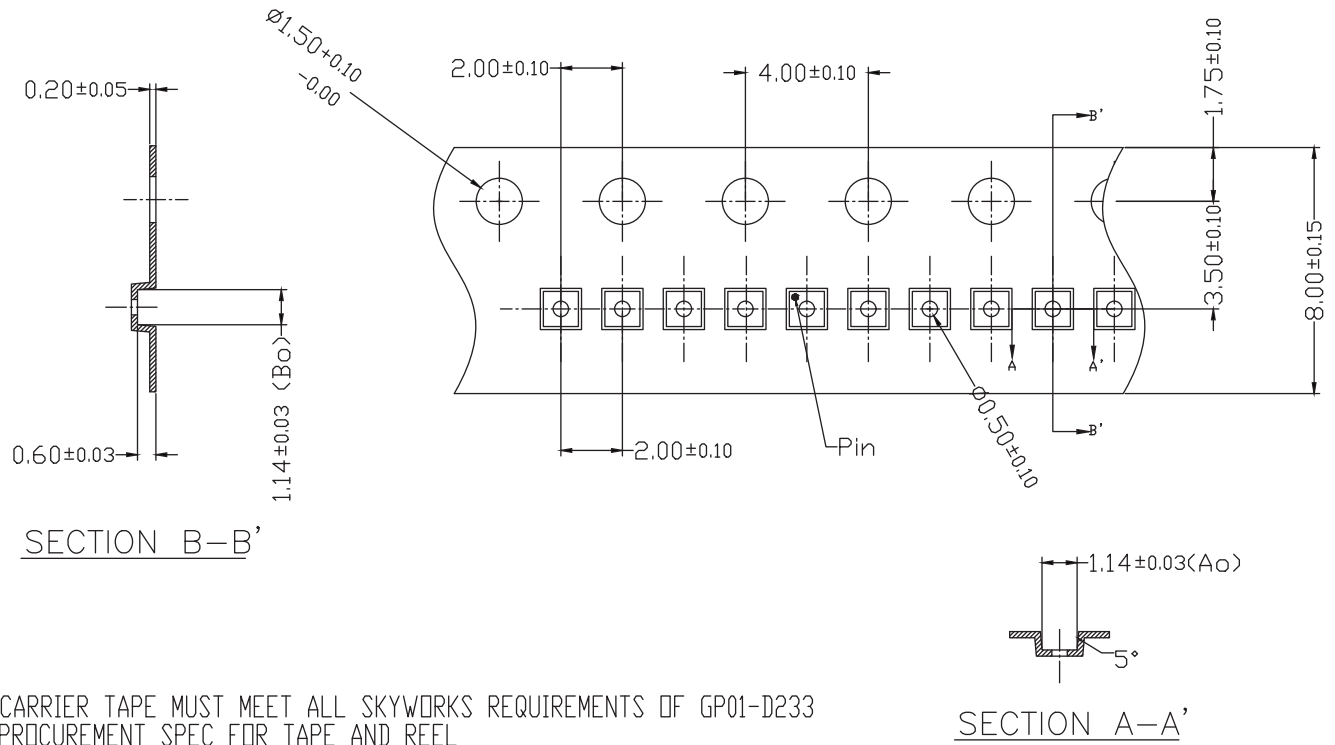

1. CARRIER TAPE MUST MEET ALL SKYWORKS REQUIREMENTS OF GP01-D233 PROCUREMENT SPEC FOR TAPE AND REEL
2. CARRIER TAPE SHALL BE BLACK CONDUCTIVE POLYCARBONATE.
3. COVER TAPE SHALL BE TRANSPARENT CONDUCTIVE MATERIAL
4. ESD-SURFACE RESISTIVITY SHALL MEET GP01-D233
5. 10 SPROCKET HOLE PITCH CUMULATIVE TOLERANCE :  $\pm 0.20\text{mm}$
6.  $A_o$  &  $B_o$  MEASURED ON PLANE  $0.30\text{mm}$  ABOVE THE BOTTOM OF THE POCKET.
7. ALL DIMENSIONS ARE IN MILLIMETERS.

SECTION A-A'

203021-015

**Figure 15. SKYA21012 Tape and Reel Dimensions**

## Ordering Information

| Part Number | Product Description                | Evaluation Board Part Number |
|-------------|------------------------------------|------------------------------|
| SKYA21012   | 20 MHz to 6.0 GHz GaAs SPDT Switch | SKYA21012-EVB                |

Copyright © 2013, 2017-2018 Skyworks Solutions, Inc. All Rights Reserved.

Information in this document is provided in connection with Skyworks Solutions, Inc. ("Skyworks") products or services. These materials, including the information contained herein, are provided by Skyworks as a service to its customers and may be used for informational purposes only by the customer. Skyworks assumes no responsibility for errors or omissions in these materials or the information contained herein. Skyworks may change its documentation, products, services, specifications or product descriptions at any time, without notice. Skyworks makes no commitment to update the materials or information and shall have no responsibility whatsoever for conflicts, incompatibilities, or other difficulties arising from any future changes.

No license, whether express, implied, by estoppel or otherwise, is granted to any intellectual property rights by this document. Skyworks assumes no liability for any materials, products or information provided hereunder, including the sale, distribution, reproduction or use of Skyworks products, information or materials, except as may be provided in Skyworks Terms and Conditions of Sale.

THE MATERIALS, PRODUCTS AND INFORMATION ARE PROVIDED "AS IS" WITHOUT WARRANTY OF ANY KIND, WHETHER EXPRESS, IMPLIED, STATUTORY, OR OTHERWISE, INCLUDING FITNESS FOR A PARTICULAR PURPOSE OR USE, MERCHANTABILITY, PERFORMANCE, QUALITY OR NON-INFRINGEMENT OF ANY INTELLECTUAL PROPERTY RIGHT; ALL SUCH WARRANTIES ARE HEREBY EXPRESSLY DISCLAIMED. SKYWORKS DOES NOT WARRANT THE ACCURACY OR COMPLETENESS OF THE INFORMATION, TEXT, GRAPHICS OR OTHER ITEMS CONTAINED WITHIN THESE MATERIALS. SKYWORKS SHALL NOT BE LIABLE FOR ANY DAMAGES, INCLUDING BUT NOT LIMITED TO ANY SPECIAL, INDIRECT, INCIDENTAL, STATUTORY, OR CONSEQUENTIAL DAMAGES, INCLUDING WITHOUT LIMITATION, LOST REVENUES OR LOST PROFITS THAT MAY RESULT FROM THE USE OF THE MATERIALS OR INFORMATION, WHETHER OR NOT THE RECIPIENT OF MATERIALS HAS BEEN ADVISED OF THE POSSIBILITY OF SUCH DAMAGE.

Skyworks products are not intended for use in medical, lifesaving or life-sustaining applications, or other equipment in which the failure of the Skyworks products could lead to personal injury, death, physical or environmental damage. Skyworks customers using or selling Skyworks products for use in such applications do so at their own risk and agree to fully indemnify Skyworks for any damages resulting from such improper use or sale.

Customers are responsible for their products and applications using Skyworks products, which may deviate from published specifications as a result of design defects, errors, or operation of products outside of published parameters or design specifications. Customers should include design and operating safeguards to minimize these and other risks. Skyworks assumes no liability for applications assistance, customer product design, or damage to any equipment resulting from the use of Skyworks products outside of stated published specifications or parameters.

Skyworks and the Skyworks symbol are trademarks or registered trademarks of Skyworks Solutions, Inc. or its subsidiaries in the United States and other countries. Third-party brands and names are for identification purposes only, and are the property of their respective owners. Additional information, including relevant terms and conditions, posted at [www.skyworksinc.com](http://www.skyworksinc.com), are incorporated by reference.

# Mouser Electronics

Authorized Distributor

Click to View Pricing, Inventory, Delivery & Lifecycle Information:

[Skyworks:](#)

[SKYA21012](#)