

DO NOT SCALE FROM THIS PRINT

TABLE 1						MATED HEIGHT WITH QSE-01
STYLE	"B"	"C"	BODY	GROUND PLANE	TERMINAL	
-01	.1680 [4.267]	.1600 [4.064]	QTE-20-01-D-XX	T-1G1-01-XXX	T-1S39-01-XXX	.197 [5.00] REF
-02	.2861 [7.267]	.2781 [7.064]	QTE-20-02-D-XX	T-1G1-02-XXX	T-1S59-02-XXX	.315 [8.00] REF
-03	.4042 [10.267]	.3962 [10.063]	QTE-20-03-D-XX	T-1G1-03-XXX	T-1S39-03-XXX	.433 [11.00] REF

TABLE 3		
No OF POS	"A"	"D"
-020	.788 [20.00]	.728 [18.48]
-040	1.575 [40.01]	1.515 [38.48]
-060	2.363 [60.01]	2.303 [58.48]
-080	3.150 [80.01]	3.090 [78.49]
-100	3.938 [100.01]	3.878 [98.49]

TABLE 2	
No OF POSITIONS	COPLANARITY INCLUDING GP
-020 THRU -060	.004 [0.10]
-080 THRU -100	.006 [0.15]

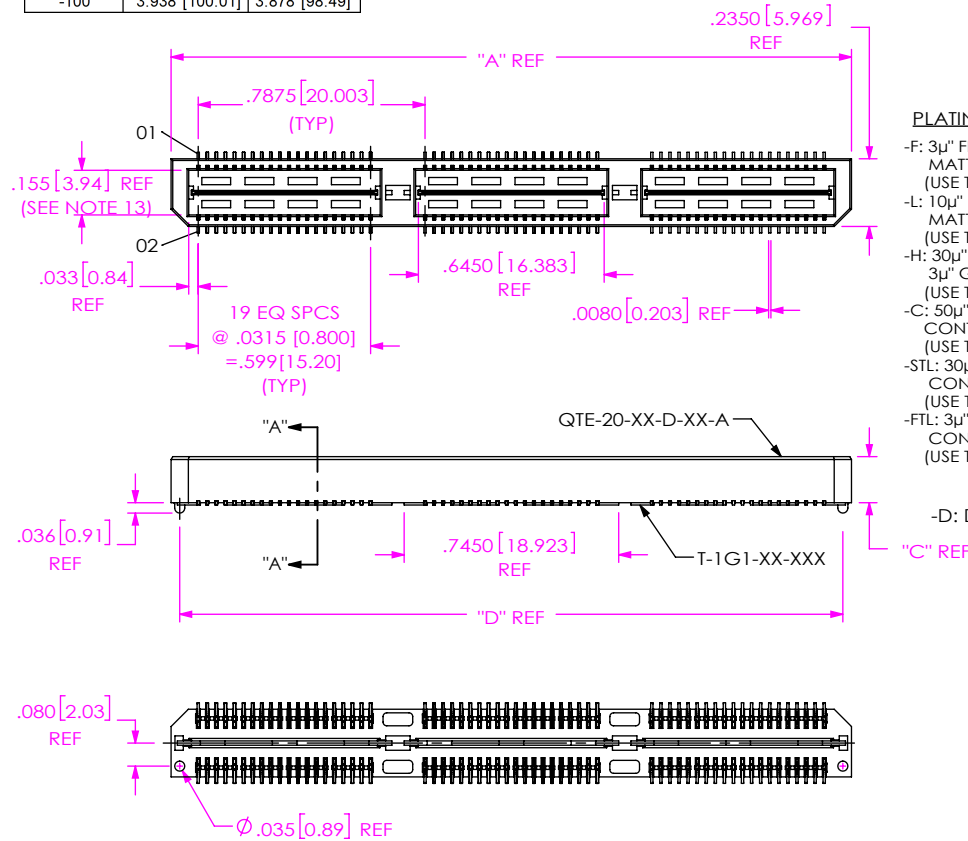

NOTES:

1. $\text{\textcircled{C}}$ REPRESENTS A CRITICAL DIMENSION.
2. MINIMUM TERMINAL RETENTION: 8 OZ.
3. MINIMUM GROUND PLANE RETENTION: 1 LB.
4. PARTS TO BE MOLDED TO POSITION.
5. MAXIMUM VARIANCE OF .002 [0.05].
6. DIMENSION APPLIES TO TERMINALS AND GROUND PLANE.
7. T-1SXX-XX-L CAN BE SUBSTITUTED FOR T-1SXX-XX-F.
8. NOTE DELETED.
9. GROUND PLANE PRESS HEIGHT MUST BE .003[0.08] LESS THAN THE MAX HEIGHT OR .001 [0.03] GREATER THAN THE MINIMUM HEIGHT OF THE TERMINALS.
10. T-1R36 RETENTION TO BODY TO BE 1.0 LBF.
11. NOTE DELETED.
12. DUE TO THE HIGH AMOUNT OF INSERTION FORCE NEEDED, THE -LC OPTION IS NOT COMPATIBLE WITH AUTO PLACEMENT. SAMTEC RECOMMENDS MANUAL PLACEMENT FOR ALL ASSEMBLIES WITH THE -LC OPTION.
13. PIN CAN EXTEND PAST WALL .003[0.08] MAX.
14. AVAILABLE FOR EXISTING CUSTOMERS ONLY.
15. NOTE DELETED.
16. NOTE DELETED.
17. NOTE DELETED.
18. TRAYS ARE STANDARD PACKAGING.
19. ORDERS WILL BE PACKAGED ACCORDING TO THE SAMTEC PACKAGING EFFICIENCY STANDARDS (SPES) FOUND ON WWW.SAMTEC.COM
20. ATACH LABEL -4X2 TO EACH REEL.

FIG 1
-A: ALIGNMENT PIN OPTION (QTE-060-01-XXX-D-A SHOWN) (STYLE -01, -02 & -03 ONLY)

QTE-XXX-XX-XXX-D-XXX-X-XX

No OF POSITIONS

- 020, -040, -060, *080, *100 (PER ROW)
- * = (SEE NOTE 14)

LEAD STYLE

- 01: .1680 [4.267]
- 02: .2861 [7.267]
- 03: .4042 [10.267]
- 04: .6010 [15.265]
- 05: .7190 [18.263]
- 06: .8370 [21.260]
- 07: .9540 [24.231]
- 08: 1.1510 [29.260]
- 09: .5220 [13.258]
- 10: .5606 [14.239]

PLATING SPECIFICATION

- F: 3 μ " FLASH GOLD IN CONTACT AREA, MATTE TIN ON TAIL (USE T-1SXX-XX-F, T-1G1-XX-F) (SEE NOTE 07)
- L: 10 μ " LIGHT GOLD IN CONTACT AREA, MATTE TIN ON TAIL (USE T-1SXX-XX-L, T-1G1-XX-L)
- H: 30 μ " HEAVY GOLD IN CONTACT AREA, 3 μ " GOLD ON TAIL (USE T-1SXX-XX-H, T-1G1-XX-G)
- C: 50 μ " ELECTRO-POLISHED SELECTIVE IN CONTACT AREA, MATTE TIN ON TAIL (USE T-1SXX-XX-C, T-1G1-XX-L)
- STL: 30 μ " HEAVY SELECTIVE GOLD IN CONTACT AREA, TIN LEAD ON TAIL (USE T-1SXX-XX-STL, T-1G1-XX-STL)
- FTL: 3 μ " FLASH SELECTIVE GOLD IN CONTACT AREA, TIN LEAD ON TAIL (USE T-1SXX-XX-FTL, T-1G1-XX-FTL)

ROW SPECIFICATION

- D: DOUBLE (USE QTE-20-XX-D-XX & QTEH-20-XX-D-XX)

No OF BANKS

PACKAGING

- BLANK: TRAYS (SEE NOTES 18 & 19)
- TR: TAPE & REEL (SEE FIG 13, SHT 7) (60 POS. MAX) (40 POS. MAX FOR -GP OPTION) (NOT AVAILABLE ON STYLE -05, -06, -07, & -08) (SEE NOTES 19 & 20)
- FR: FULL REEL QTY. TAPE & REEL (60 POS. MAX) (40 POS. MAX FOR -GP OPTION) (NOT AVAILABLE ON STYLE -05, -06, -07, & -08) (SEE NOTES 19 & 20)

PICK & PLACE PAD

- K: POLYIMIDE FILM (SEE FIG 3, SHT 2) (NOT AVAILABLE ON STYLE -07, & -08)

OPTION

- A: ALIGNMENT PINS
- LC: LOCKING CLIPS (SEE NOTE 12) (SEE FIG 2, SHT 2)
- GP: GUIDE POSTS (SEE FIG 4, SHT 3) (AVAILABLE ON -01 ONLY) (T & R PACK: 40 POS. MAX.)
- SD: SCREW DOWN (SEE FIG 5, SHT 3) (AVAILABLE ON -01 ONLY) (N/A WITH -GP)
- FL: FRICTION LOCKS (SEE FIG 9, SHT 5) (AVAILABLE ON -01 & -02 ONLY) (NOT AVAILABLE WITH -GP, -SD)
- RT1: RETENTION OPTION (SEE FIG 11, SHT 6) (AVAILABLE ON -01 ONLY) (NOT AVAILABLE WITH -LC, -GP, -SD, OR -FL) (NOT AVAILABLE ON -100 POS)
- L: LATCHING OPTION (40 POS. MAX.) (SEE FIG 12, SHT 6) (AVAILABLE ON -A ONLY) (AVAILABLE ON -01 ONLY) (NOT AVAILABLE WITH -LC, -GP, -SD, -FL, OR -RT1)

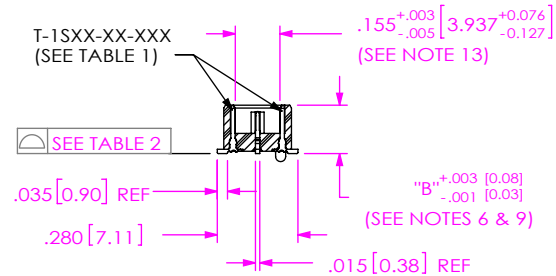

SECTION "A"-"A"

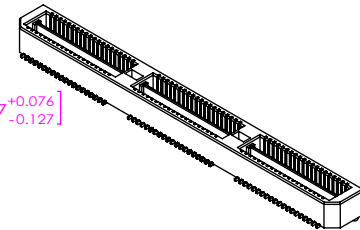

UNLESS OTHERWISE SPECIFIED, DIMENSIONS ARE IN INCHES. TOLERANCES ARE:		PROPRIETARY NOTE	 <p>520 PARK EAST BLVD, NEW ALBANY, IN 47150 PHONE: 812-944-6733 FAX: 812-948-5047 e-Mail info@SAMTEC.com code 55322</p>
DECIMALS	ANGLES	<p>THIS DOCUMENT CONTAINS CONFIDENTIAL AND PROPRIETARY INFORMATION AND ALL DESIGN, MANUFACTURING, REPRODUCTION, USE, PATENT RIGHTS AND SALES RIGHTS ARE EXPRESSLY RESERVED BY SAMTEC, INC. THIS DOCUMENT SHALL NOT BE DISCLOSED, IN WHOLE OR PART, TO ANY UNAUTHORIZED PERSON OR ENTITY NOR REPRODUCED, TRANSFERRED OR INCORPORATED IN ANY OTHER PROJECT IN ANY MANNER WITHOUT THE EXPRESS WRITTEN CONSENT OF SAMTEC, INC.</p>	
.XX: ± 0.1 [0.3]	2°		DESCRIPTION: .8mm DOUBLE ROW HS TERMINAL ASSEMBLY
.XXX: ± 0.05 [0.13]			DWG. NO. QTE-XXX-XX-XXX-D-XXX-X-XX
.XXXX: ± 0.020 [0.051]			BY: DEAN P 09-14-2010 SHEET 1 OF 7
<p>MATERIAL: DO NOT SCALE DRAWING SHEET SCALE: 1.5:1</p> <p>INSULATOR: LCP, UL94V-0; COLOR: BLACK</p> <p>TERMINAL: PHOS BRONZE</p> <p>GROUND PLANE: PHOS BRONZE</p>			
<p>F:\DWG\MISC\MKTG\QTE-XXX-XX-XXX-D-XXX-X-XX-MKT.SLDDRW</p>			

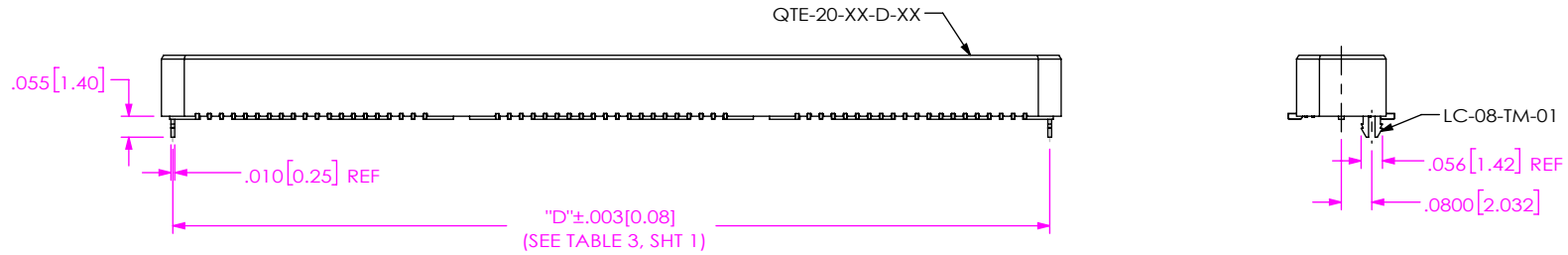

FIG 2
 -LC: LOCKING CLIP OPTION
 (QTE-060-01-XXX-D-LC SHOWN)
 (DIFFERENT AS SHOWN, OTHERWISE SAME AS FIG 1)

No OF POS	"R"				"S"			
	-LC, -A, -FL	-GP, -SD	-RT1	-L	-LC, -A, -FL	-GP, -SD	-RT1	-L
-020	.788 [20.00]	1.305 [33.15]	1.438 [36.53]	.906 [23.00]	.256 [6.50]	.515 [13.07]	.581 [14.76]	.315 [7.99]
-040	1.575 [40.01]	2.093 [53.15]	2.226 [56.53]	1.693 [43.00]	.650 [16.50]	.908 [23.07]	.975 [24.76]	.709 [18.00]
-060	2.363 [60.01]	2.880 [73.15]	3.013 [76.53]	N/A	1.043 [26.50]	1.302 [33.07]	1.369 [34.76]	N/A
-080	3.150 [80.01]	3.668 [93.15]	3.801 [96.53]	N/A	1.437 [36.50]	1.696 [43.07]	1.762 [44.76]	N/A
-100	3.938 [100.01]	4.455 [113.16]	N/A	N/A	1.831 [46.50]	2.090 [53.07]	N/A	N/A

STYLE	"T"
-01	.173[4.39]
-02	.291[7.39]
-03	.409[10.39]
-04	.605[15.37]
-05	.721[18.31]
-06	.840[21.33]
-09	.528 [13.41]
-10	.567[14.37]

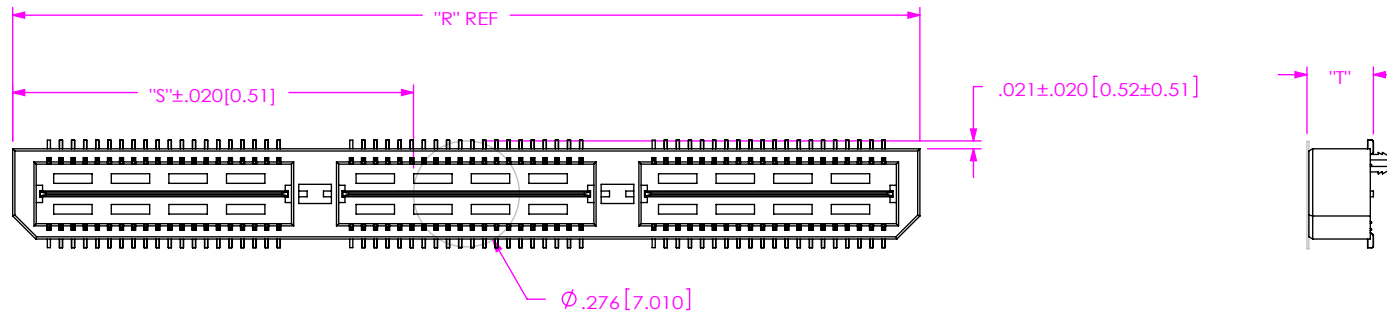

FIG 3
 -K: POLYIMIDE FILM PAD
 (USE K-DOT-.276-.375-.005)

DO NOT SCALE DRAWING SHEET SCALE: 2:1	<p>PROPRIETARY NOTE</p> <p>THIS DOCUMENT CONTAINS CONFIDENTIAL AND PROPRIETARY INFORMATION AND ALL DESIGN, MANUFACTURING, REPRODUCTION, USE, PATENT RIGHTS AND SALES RIGHTS ARE EXPRESSLY RESERVED BY SAMTEC, INC. THIS DOCUMENT SHALL NOT BE DISCLOSED, IN WHOLE OR PART, TO ANY UNAUTHORIZED PERSON OR ENTITY NOR REPRODUCED, TRANSFERRED OR INCORPORATED IN ANY OTHER PROJECT IN ANY MANNER WITHOUT THE EXPRESS WRITTEN CONSENT OF SAMTEC, INC.</p>	<p>samtec</p> <p>520 PARK EAST BLVD, NEW ALBANY, IN 47150 PHONE: 812-944-6733 FAX: 812-948-5047 e-Mail: info@SAMTEC.com code 55322</p>
	DESCRIPTION: .8mm DOUBLE ROW HS TERMINAL ASSEMBLY	
	DWG. NO. QTE-XXX-XX-XXX-D-XXX	
BY: DEAN P 09-14-2010 SHEET 2 OF 7		

TABLE 6		
POS	"E"	"F"
-020	1.305 [33.15]	1.013 [25.72]
-040	2.093 [53.15]	1.800 [45.72]
-060	2.880 [73.15]	2.588 [65.72]
-080	3.668 [93.15]	3.375 [85.73]
-100	4.455 [113.16]	4.163 [105.73]

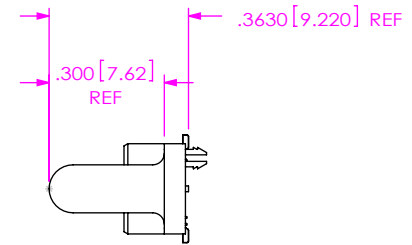
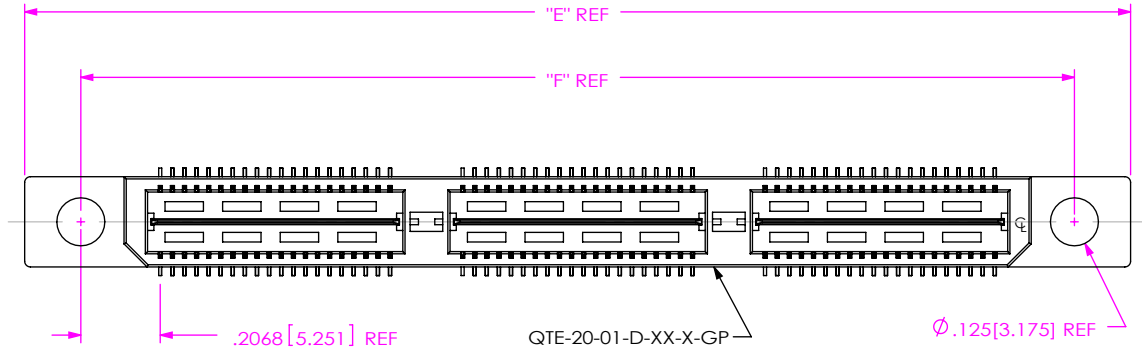

FIG 4
 -GP: GUIDE POST OPTION
 (QTE-060-01-XXX-D-GP SHOWN)
 (DIFFERENT AS SHOWN, OTHERWISE SAME AS FIG 1)
 (AVAILABLE ON STYLE -01 ONLY)

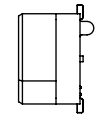
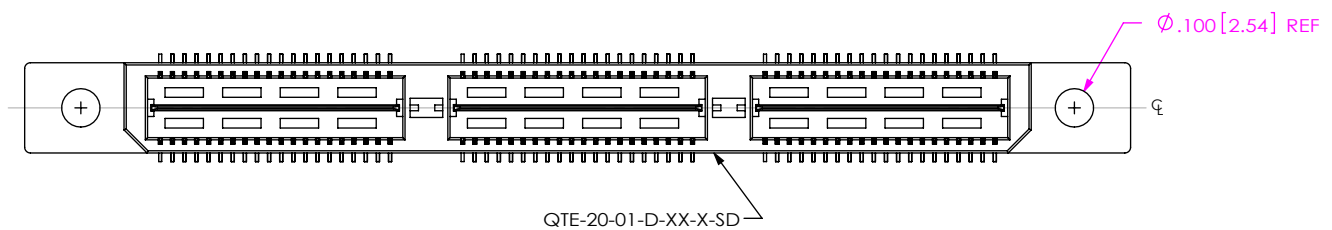

FIG 5
 -SD: SCREW DOWN OPTION
 (QTE-060-01-XXX-D-A-SD SHOWN)
 (DIFFERENT AS SHOWN, OTHERWISE SAME AS FIG 4)
 (AVAILABLE ON STYLE -01 ONLY)

<p>DO NOT SCALE DRAWING</p> <p>SHEET SCALE: 2:1</p>	<p>PROPRIETARY NOTE</p> <p>THIS DOCUMENT CONTAINS CONFIDENTIAL AND PROPRIETARY INFORMATION AND ALL DESIGN, MANUFACTURING, REPRODUCTION, USE, PATENT RIGHTS AND SALES RIGHTS ARE EXPRESSLY RESERVED BY SAMTEC, INC. THIS DOCUMENT SHALL NOT BE DISCLOSED, IN WHOLE OR PART, TO ANY UNAUTHORIZED PERSON OR ENTITY NOR REPRODUCED, TRANSFERRED OR INCORPORATED IN ANY OTHER PROJECT IN ANY MANNER WITHOUT THE EXPRESS WRITTEN CONSENT OF SAMTEC, INC.</p>	<p>samtec</p> <p>520 PARK EAST BLVD, NEW ALBANY, IN 47150 PHONE: 812-944-6733 FAX: 812-948-5047 e-Mail info@SAMTEC.com code 55322</p>
	<p>DESCRIPTION: .8mm DOUBLE ROW HS TERMINAL ASSEMBLY</p>	
	<p>DWG. NO. QTE-XXX-XX-XXX-D-XXX-X- BY: DEAN P 09-14-2010 SHEET 3 OF 7</p>	

FIG 6
QTE-060-04-X-D-LC SHOWN
(DIFFERENT AS SHOWN, OTHERWISE SAME AS FIG 1)
(STYLES -04, -05 & -06)

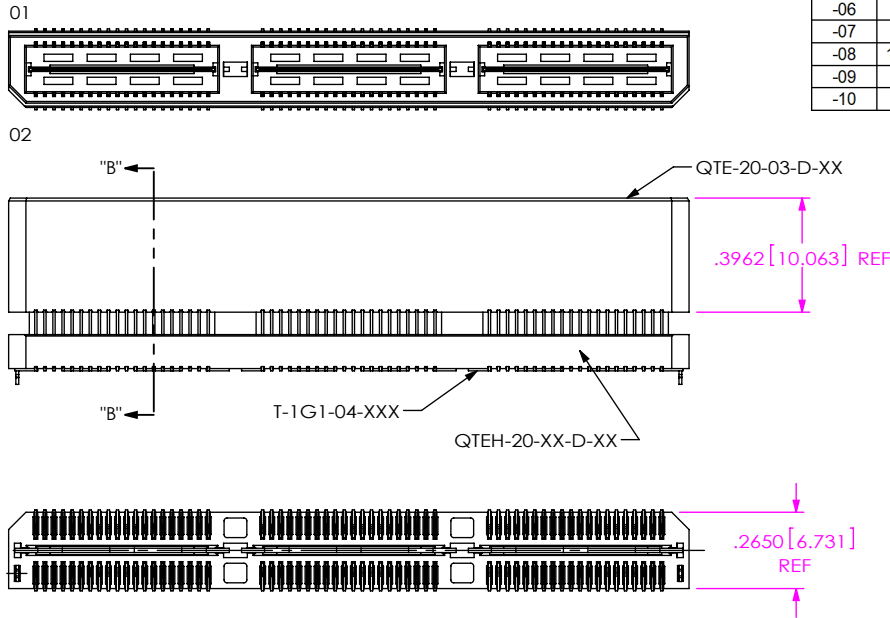

TABLE 7						MATED HEIGHT WITH QSE-01
STYLE	"B"	GROUND PLANE	TERMINAL	BOTTOM SPACER BODY	TOP BODY	
-04	.6010 [15.265]	T-1G1-04-XXX	T-1S41-04-XXX	QTEH-20-01-D-XX-X	QTE-20-03-D-XX-X	.630[16.00] REF
-05	.7190 [18.263]	T-1G1-05-XXX	T-1S41-05-XXX	QTEH-20-01-D-XX-X	QTE-20-03-D-XX-X	.748[19.00] REF
-06	.8370 [21.260]	T-1G1-06-XXX	T-1S41-06-XXX	QTEH-20-02-D-XX-X	QTE-20-03-D-XX-X	.866[22.00] REF
-07	.9540 [24.232]	T-1G17-01-XXX	T-1S61-21-XXX	QTEH-20-04-D-XX-X	QTE-20-02-D-XX-X	.984[25.00] REF
-08	1.1510 [29.235]	T-1G17-02-XXX	T-1S61-22-XXX	QTEH-20-04-D-XX-X	QTE-20-02-D-XX-X	1.181[30.00] REF
-09	.5220 [13.259]	T-1G1-09-XXX	T-1S60-09-XXX	QTEH-20-01-D-XX-X	QTE-20-02-D-XX-X	.551[14.00] REF
-10	.5606 [14.239]	T-1G1-10-XXX	T-1S60-10-XXX	QTEH-20-01-D-XX-X	QTE-20-02-D-XX-X	.591[15.00] REF

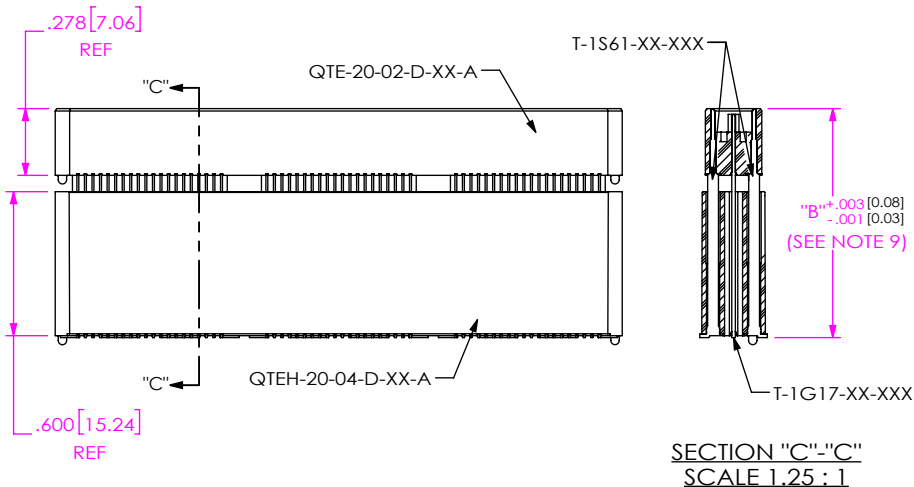
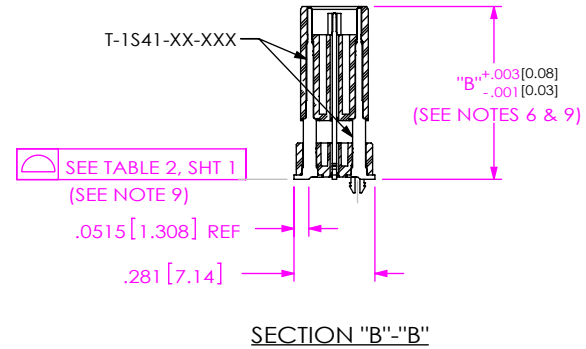

FIG 7
QTE-060-07-X-D-A SHOWN
(DIFFERENT AS SHOWN, OTHERWISE SAME AS FIG 6)
(STYLES -07 & -08)

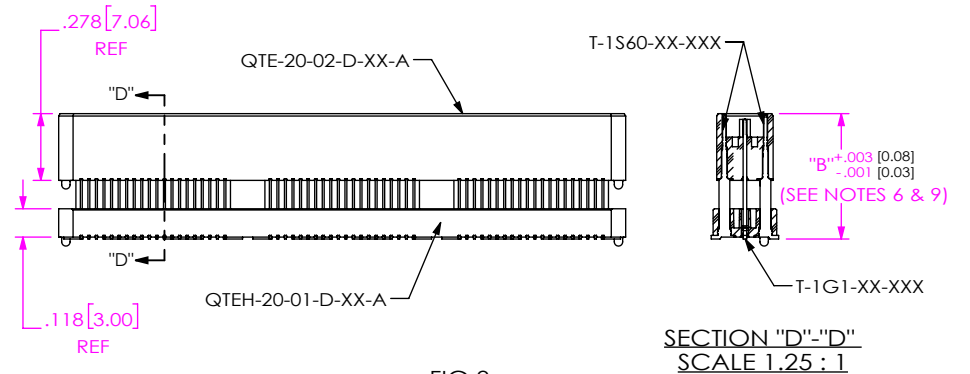

FIG 8
QTE-060-09-X-D-A SHOWN
(DIFFERENT AS SHOWN, OTHERWISE SAME AS FIG 6)
(STYLES -09 & -10)

F:\DWG\MISC\MKTG\QTE-XXX-XX-XXX-D-XXX-X-XX-MKT.SLDDRW

PROPRIETARY NOTE

THIS DOCUMENT CONTAINS CONFIDENTIAL AND PROPRIETARY INFORMATION AND ALL DESIGN, MANUFACTURING, REPRODUCTION, USE, PATENT RIGHTS AND SALES RIGHTS ARE EXPRESSLY RESERVED BY SAMTEC, INC. THIS DOCUMENT SHALL NOT BE DISCLOSED, IN WHOLE OR PART, TO ANY UNAUTHORIZED PERSON OR ENTITY NOR REPRODUCED, TRANSFERRED OR INCORPORATED IN ANY OTHER PROJECT IN ANY MANNER WITHOUT THE EXPRESS WRITTEN CONSENT OF SAMTEC, INC.



520 PARK EAST BLVD, NEW ALBANY, IN 47150
PHONE: 812-944-6733 FAX: 812-948-5047
e-Mail: info@SAMTEC.com code 55322

DO NOT SCALE DRAWING

SHEET SCALE: 1.5:1

DESCRIPTION:
.8mm DOUBLE ROW HS TERMINAL ASSEMBLY

DWG. NO.

QTE-XXX-XX-XXX-D-XXX

BY: DEAN P 09-14-2010 SHEET 4 OF 7

FIG 9
 -FL: FRICTION LOCKS
 (QTE-020-01-XXX-D-A-FL SHOWN)
 (DIFFERENT AS SHOWN, OTHERWISE SAME AS FIG 1)
 (ONLY AVAILABLE ON -01 & -02 LEAD STYLES)
 (NOT AVAILABLE WITH -GP, -SD OPTIONS)

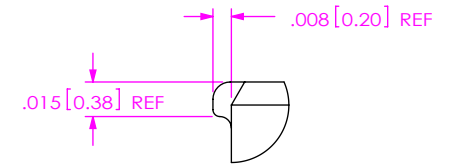
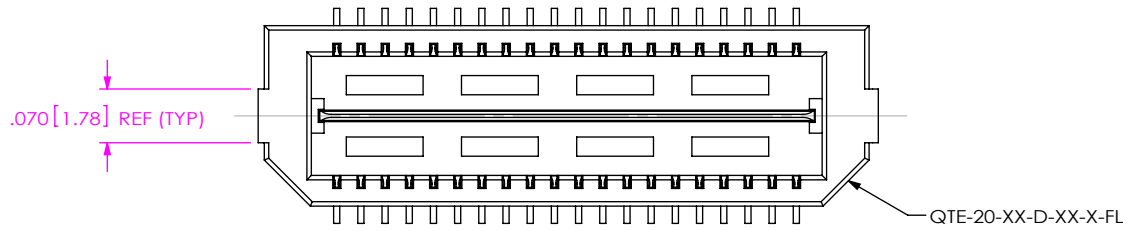

DETAIL 'E'
 SCALE 12 : 1

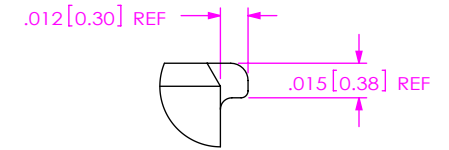
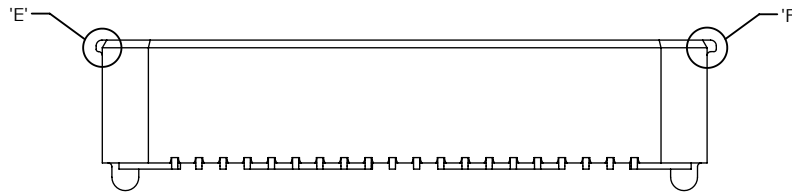

DETAIL 'F'
 SCALE 12 : 1

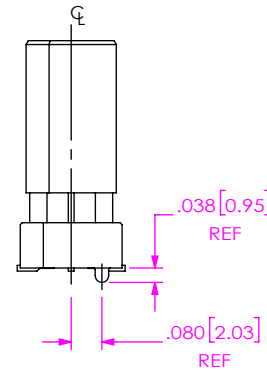
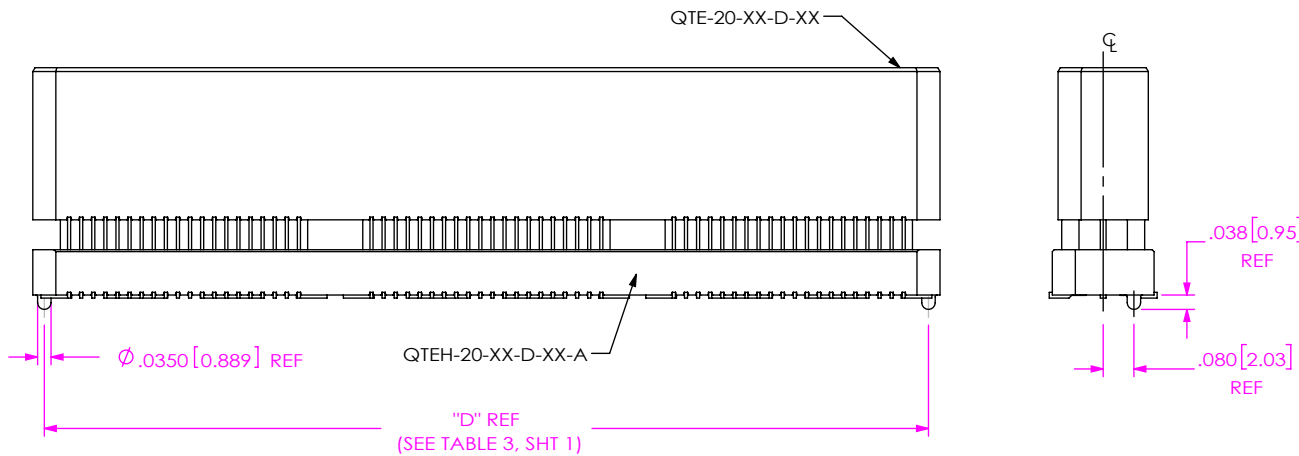

FIG 10
 (QTE-060-04-XXX-D-A SHOWN)
 (DIFFERENT AS SHOWN, OTHERWISE SAME AS FIG 1)
 (STYLES -04, -05, -06, -07, -08, -09 & -10, SEE TABLE 7, SHT 4)

PROPRIETARY NOTE

THIS DOCUMENT CONTAINS CONFIDENTIAL AND PROPRIETARY INFORMATION AND ALL DESIGN, MANUFACTURING, REPRODUCTION, USE, PATENT RIGHTS AND SALES RIGHTS ARE EXPRESSLY RESERVED BY SAMTEC, INC. THIS DOCUMENT SHALL NOT BE DISCLOSED, IN WHOLE OR PART, TO ANY UNAUTHORIZED PERSON OR ENTITY NOR REPRODUCED, TRANSFERRED OR INCORPORATED IN ANY OTHER PROJECT IN ANY MANNER WITHOUT THE EXPRESS WRITTEN CONSENT OF SAMTEC, INC.



520 PARK EAST BLVD, NEW ALBANY, IN 47150
 PHONE: 812-944-6733 FAX: 812-948-5047
 e-Mail: info@SAMTEC.com code 55322

DO NOT SCALE DRAWING

SHEET SCALE: 2:1

DESCRIPTION:
 .8mm DOUBLE ROW HS TERMINAL ASSEMBLY

DWG. NO.
QTE-XXX-XX-XXX-D-XXX

BY: DEAN P 09-14-2010 SHEET 5 OF 7

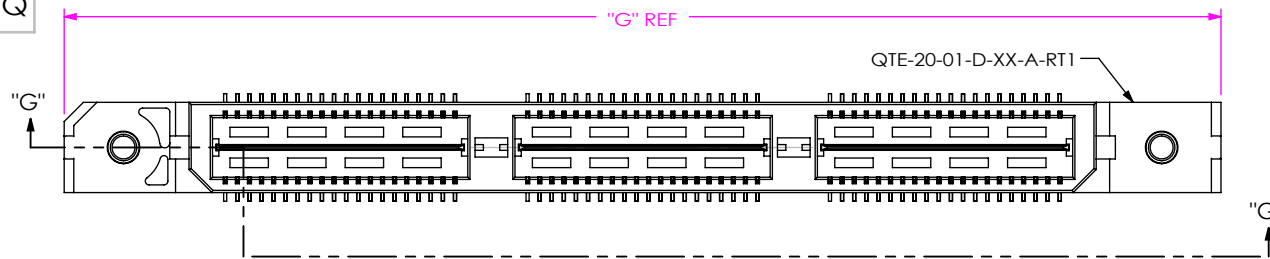

POS	"G"	"H"
-020	1.438 [36.53]	1.129 [28.68]
-040	2.226 [56.53]	1.917 [48.68]
-060	3.013 [76.53]	2.704 [68.68]
-080	3.801 [96.53]	3.492 [88.68]
-100	N/A	N/A

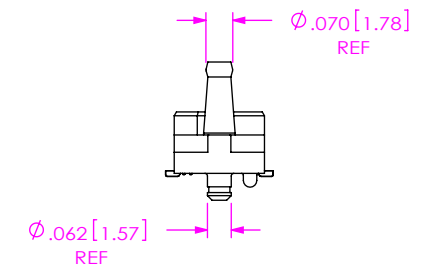
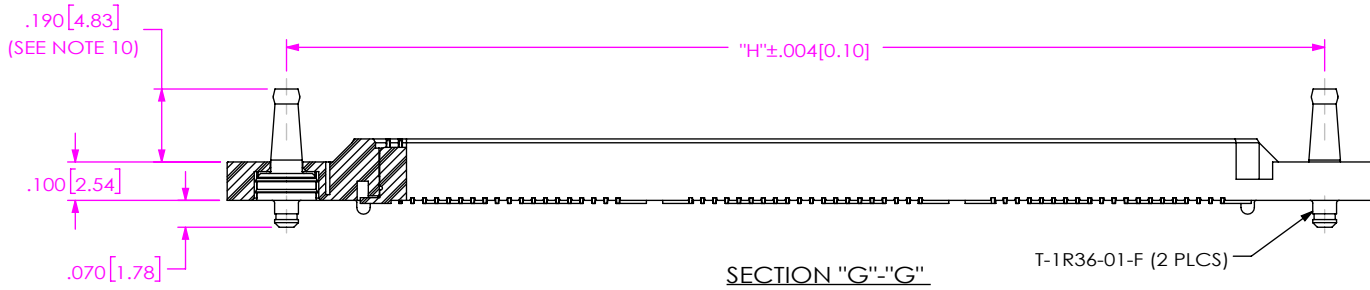
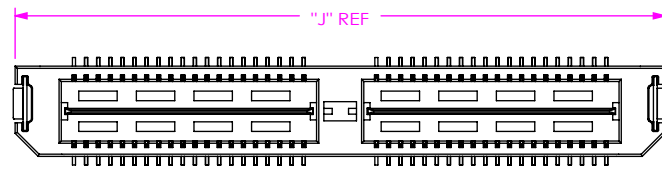

FIG 11
 -RT1: RETENTION OPTION
 (QTE-060-01-XXX-D-A-RT1 SHOWN)
 (DIFFERENT AS SHOWN, OTHERWISE SAME AS FIG 1)
 (ONLY AVAILABLE ON -01 LEAD STYLE) (MUST USE -A OPTION)
 (NOT AVAILABLE WITH -LC, -GP, -SD, OR -FL OPTIONS)
 (NOT AVAILABLE ON -100 POSITION)



POS	"J"	"K"	"L"
-020	.906 [23.00]	.915 [23.24]	.854 [21.69]
-040	1.693 [43.00]	1.703 [43.24]	1.642 [41.69]
-060	N/A	N/A	N/A
-080	N/A	N/A	N/A
-100	N/A	N/A	N/A

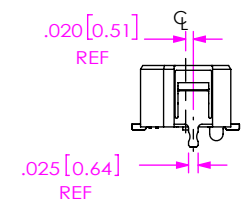
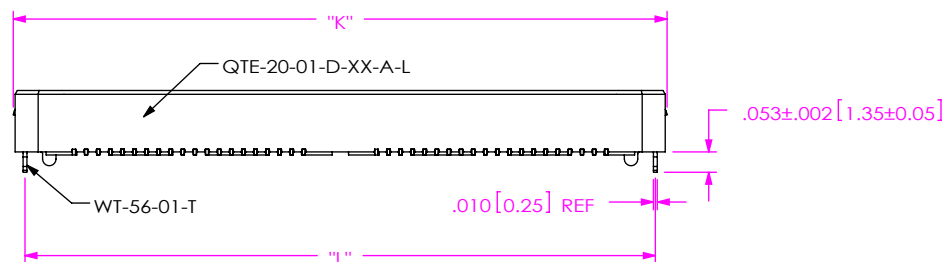

FIG 12
 -L: LATCHING OPTION
 (QTE-040-01-XXX-D-A-L SHOWN)
 (DIFFERENT AS SHOWN, OTHERWISE SAME AS FIG 1)
 (40 POS. MAX.) (MUST USE -A OPTION)
 (AVAILABLE ON -01 LEAD STYLE ONLY)
 (NOT AVAILABLE WITH -LC, -GP, -SD, -FL, OR -RT1)

PROPRIETARY NOTE
 THIS DOCUMENT CONTAINS CONFIDENTIAL AND PROPRIETARY INFORMATION AND ALL DESIGN, MANUFACTURING, REPRODUCTION, USE, PATENT RIGHTS AND SALES RIGHTS ARE EXPRESSLY RESERVED BY SAMTEC, INC. THIS DOCUMENT SHALL NOT BE DISCLOSED, IN WHOLE OR PART, TO ANY UNAUTHORIZED PERSON OR ENTITY NOR REPRODUCED, TRANSFERRED OR INCORPORATED IN ANY OTHER PROJECT IN ANY MANNER WITHOUT THE EXPRESS WRITTEN CONSENT OF SAMTEC, INC.



520 PARK EAST BLVD, NEW ALBANY, IN 47150
 PHONE: 812-944-6733 FAX: 812-948-5047
 e-Mail: info@SAMTEC.com code 55322

DO NOT SCALE DRAWING
 SHEET SCALE: 2:1

DESCRIPTION:
 .8mm DOUBLE ROW HS TERMINAL ASSEMBLY
 DWG. NO.

QTE-XXX-XX-XXX-D-XXX

BY: DEAN P 09-14-2010 SHEET 6 OF 7

FIG 13
 -TR: PACKAGING OPTION
 (QTE-060-01-XXX-D-LC-TR SHOWN)
 (DIFFERENT AS SHOWN, OTHERWISE SAME AS FIG 1)
 (60 POS MAX)
 (40 POS MAX WITH -GP OPTION)
 (NOT AVAILABLE ON LEAD SYTTLES -05, -06, -07 & -08)

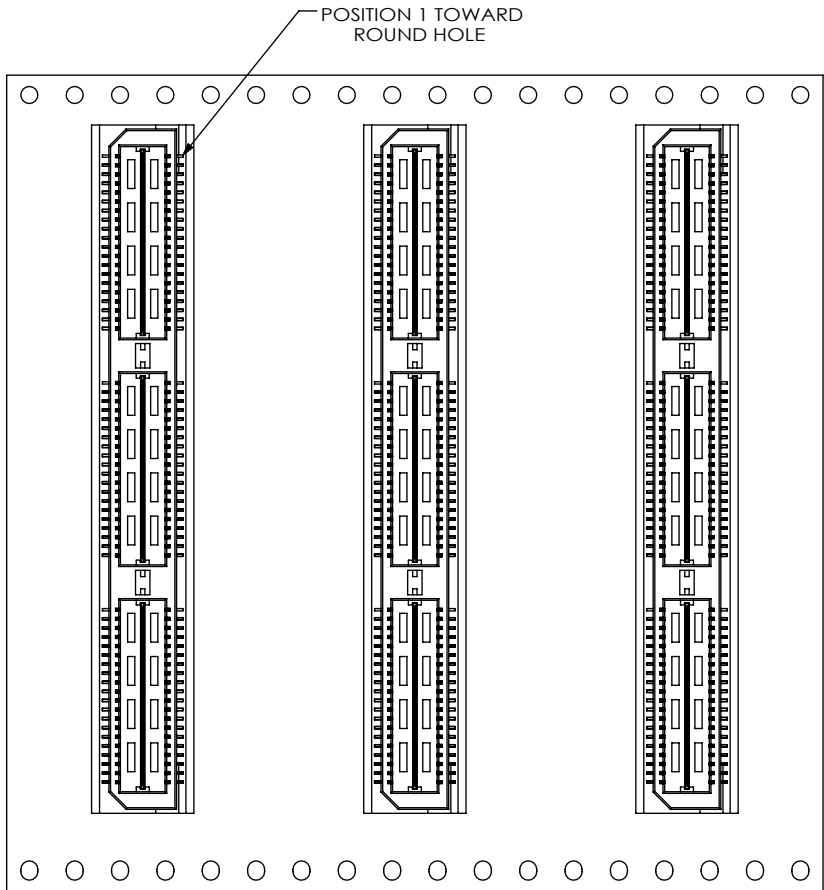

USER DIRECTION OF UN-REELING →
 POCKET NOT DETAILED

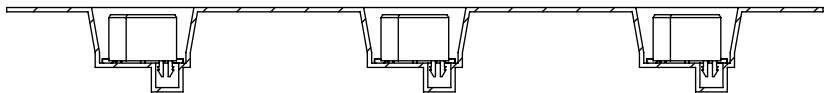

CRITICAL DIMENSION INSPECTION INSTRUCTION TABLE	
ASSEMBLY OPERATION	IN PROCESS INSPECTION
FILL T-1SXX	C1, C2, C4, C5, C13
ADD -LC OPTION	C14
ADD -RT1 OPTION	C6, C8
ADD -L OPTION	C9, C10, C11
ADD -K OPTION	C16, C15
CPC'S INTENTIONALLY DELETED: C7, C12	

PROPRIETARY NOTE
 THIS DOCUMENT CONTAINS CONFIDENTIAL AND PROPRIETARY INFORMATION AND ALL DESIGN, MANUFACTURING, REPRODUCTION, USE, PATENT RIGHTS AND SALES RIGHTS ARE EXPRESSLY RESERVED BY SAMTEC, INC. THIS DOCUMENT SHALL NOT BE DISCLOSED, IN WHOLE OR PART, TO ANY UNAUTHORIZED PERSON OR ENTITY NOR REPRODUCED, TRANSFERRED OR INCORPORATED IN ANY OTHER PROJECT IN ANY MANNER WITHOUT THE EXPRESS WRITTEN CONSENT OF SAMTEC, INC.



520 PARK EAST BLVD, NEW ALBANY, IN 47150
 PHONE: 812-944-6733 FAX: 812-948-5047
 e-Mail info@SAMTEC.com code 55322

DO NOT SCALE DRAWING

SHEET SCALE: 1:0.8

DESCRIPTION:
 .8mm DOUBLE ROW HS TERMINAL ASSEMBLY

DWG. NO. QTE-XXX-XX-XXX-D-XXX

BY: DEAN P 09-14-2010 SHEET 7 OF 7