

SERIES: PDM1-S | **DESCRIPTION:** DC-DC CONVERTER**FEATURES**

- 1 W isolated output
- smaller package
- single/dual unregulated output
- 1,500 Vdc isolation
- short circuit protection
- extended temperature range (-40~105°C)
- antistatic protection up to 8kV
- high efficiency at light load
- efficiency up to 80%

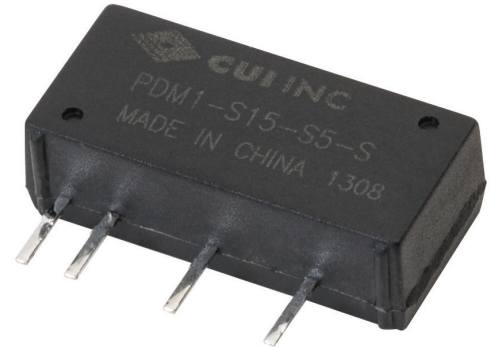

| MODEL | input voltage | | output voltage | output current | | output power | ripple and noise ² | efficiency |
|-------------------------------|---------------|-------------|----------------|----------------|----------|--------------|-------------------------------|------------|
| | typ (Vdc) | range (Vdc) | (Vdc) | min (mA) | max (mA) | max (W) | typ (mVp-p) | typ (%) |
| PDM1-S3-S3-S* | 3.3 | 2.97~3.63 | 3.3 | 31 | 303 | 1 | 60 | 72 |
| PDM1-S3-S5-S* | 3.3 | 2.97~3.63 | 5 | 20 | 200 | 1 | 60 | 78 |
| PDM1-S3-S9-S* | 3.3 | 2.97~3.63 | 9 | 11 | 111 | 1 | 60 | 78 |
| PDM1-S3-S12-S* | 3.3 | 2.97~3.63 | 12 | 9 | 84 | 1 | 60 | 78 |
| PDM1-S3-S15-S* | 3.3 | 2.97~3.63 | 15 | 7 | 67 | 1 | 60 | 78 |
| PDM1-S3-D5-S* | 3.3 | 2.97~3.63 | ±5 | ±10 | ±100 | 1 | 60 | 78 |
| PDM1-S3-D12-S* | 3.3 | 2.97~3.63 | ±12 | ±5 | ±42 | 1 | 60 | 78 |
| PDM1-S3-D15-S* | 3.3 | 2.97~3.63 | ±15 | ±4 | ±34 | 1 | 60 | 76 |
| PDM1-S5-S3-S* | 5 | 4.5~5.5 | 3.3 | 31 | 303 | 1 | 60 | 74 |
| PDM1-S5-S5-S ^{1,*} | 5 | 4.5~5.5 | 5 | 20 | 200 | 1 | 60 | 80 |
| PDM1-S5-S9-S ^{1,*} | 5 | 4.5~5.5 | 9 | 11 | 111 | 1 | 60 | 80 |
| PDM1-S5-S12-S ^{1,*} | 5 | 4.5~5.5 | 12 | 9 | 84 | 1 | 60 | 80 |
| PDM1-S5-S15-S ^{1,*} | 5 | 4.5~5.5 | 15 | 7 | 67 | 1 | 60 | 80 |
| PDM1-S5-S24-S ^{1,*} | 5 | 4.5~5.5 | 24 | 5 | 42 | 1 | 60 | 80 |
| PDM1-S5-D3-S | 5 | 4.5~5.5 | ±3.3 | ±15 | ±152 | 1 | 60 | 71 |
| PDM1-S5-D5-S ^{1,*} | 5 | 4.5~5.5 | ±5 | ±10 | ±100 | 1 | 60 | 80 |
| PDM1-S5-D9-S ^{1,*} | 5 | 4.5~5.5 | ±9 | ±6 | ±56 | 1 | 60 | 80 |
| PDM1-S5-D12-S ¹ | 5 | 4.5~5.5 | ±12 | ±5 | ±42 | 1 | 60 | 80 |
| PDM1-S5-D15-S ¹ | 5 | 4.5~5.5 | ±15 | ±4 | ±34 | 1 | 60 | 80 |
| PDM1-S5-D24-S ^{1,*} | 5 | 4.5~5.5 | ±24 | ±3 | ±21 | 1 | 60 | 80 |
| PDM1-S9-D9-S* | 9 | 8.1~9.9 | ±9 | ±6 | ±56 | 1 | 60 | 80 |
| PDM1-S9-D15-S* | 9 | 8.1~9.9 | ±15 | ±4 | ±34 | 1 | 60 | 80 |
| PDM1-S12-S3-S* | 12 | 10.8~13.2 | 3.3 | 31 | 303 | 1 | 60 | 76 |
| PDM1-S12-S5-S ¹ | 12 | 10.8~13.2 | 5 | 20 | 200 | 1 | 60 | 80 |
| PDM1-S12-S9-S ^{1,*} | 12 | 10.8~13.2 | 9 | 11 | 111 | 1 | 60 | 80 |
| PDM1-S12-S12-S ^{1,*} | 12 | 10.8~13.2 | 12 | 9 | 84 | 1 | 60 | 80 |
| PDM1-S12-S15-S ^{1,*} | 12 | 10.8~13.2 | 15 | 7 | 67 | 1 | 60 | 80 |

Notes: 1. UL approved
 2. Ripple and noise are measured at 20 MHz BW by "parallel cable" method with 1 μF ceramic and 10 μF electrolytic capacitors on the output.
 3. * Discontinued model.

| MODEL (CONTINUED) | input voltage | | output voltage | output current | | output power | ripple and noise ² | efficiency |
|-------------------------------|---------------|-------------|----------------|----------------|----------|--------------|-------------------------------|------------|
| | typ (Vdc) | range (Vdc) | (Vdc) | min (mA) | max (mA) | max (W) | typ (mVp-p) | typ (%) |
| PDM1-S12-S24-S ^{1,*} | 12 | 10.8~13.2 | 24 | 5 | 42 | 1 | 60 | 80 |
| PDM1-S12-D3-S* | 12 | 10.8~13.2 | ±3.3 | ±15 | ±152 | 1 | 60 | 76 |
| PDM1-S12-D5-S ^{1,*} | 12 | 10.8~13.2 | ±5 | ±10 | ±100 | 1 | 60 | 80 |
| PDM1-S12-D9-S ^{1,*} | 12 | 10.8~13.2 | ±9 | ±6 | ±56 | 1 | 60 | 80 |
| PDM1-S12-D12-S ¹ | 12 | 10.8~13.2 | ±12 | ±5 | ±42 | 1 | 60 | 80 |
| PDM1-S12-D15-S ¹ | 12 | 10.8~13.2 | ±15 | ±4 | ±34 | 1 | 60 | 80 |
| PDM1-S12-D24-S ^{1,*} | 12 | 10.8~13.2 | ±24 | ±3 | ±21 | 1 | 60 | 80 |
| PDM1-S15-S5-S* | 15 | 13.5~16.5 | 5 | 20 | 200 | 1 | 60 | 80 |
| PDM1-S15-S9-S* | 15 | 13.5~16.5 | 9 | 11 | 111 | 1 | 60 | 80 |
| PDM1-S15-S12-S* | 15 | 13.5~16.5 | 12 | 9 | 84 | 1 | 60 | 80 |
| PDM1-S15-S15-S* | 15 | 13.5~16.5 | 15 | 7 | 67 | 1 | 60 | 80 |
| PDM1-S15-S24-S* | 15 | 13.5~16.5 | 24 | 5 | 42 | 1 | 60 | 80 |
| PDM1-S15-D5-S* | 15 | 13.5~16.5 | ±5 | ±10 | ±100 | 1 | 60 | 80 |
| PDM1-S15-D9-S* | 15 | 13.5~16.5 | ±9 | ±6 | ±56 | 1 | 60 | 80 |
| PDM1-S15-D12-S* | 15 | 13.5~16.5 | ±12 | ±5 | ±42 | 1 | 60 | 80 |
| PDM1-S15-D15-S* | 15 | 13.5~16.5 | ±15 | ±4 | ±34 | 1 | 60 | 80 |
| PDM1-S15-D24-S* | 15 | 13.5~16.5 | ±24 | ±3 | ±21 | 1 | 60 | 80 |
| PDM1-S24-S3-S* | 24 | 21.6~26.4 | 3.3 | 31 | 303 | 1 | 60 | 74 |
| PDM1-S24-S5-S ^{1,*} | 24 | 21.6~26.4 | 5 | 20 | 200 | 1 | 60 | 80 |
| PDM1-S24-S9-S ^{1,*} | 24 | 21.6~26.4 | 9 | 11 | 111 | 1 | 60 | 80 |
| PDM1-S24-S12-S ^{1,*} | 24 | 21.6~26.4 | 12 | 9 | 84 | 1 | 60 | 80 |
| PDM1-S24-S15-S ^{1,*} | 24 | 21.6~26.4 | 15 | 7 | 67 | 1 | 60 | 80 |
| PDM1-S24-S24-S ¹ | 24 | 21.6~26.4 | 24 | 5 | 42 | 1 | 60 | 80 |
| PDM1-S24-D5-S ^{1,*} | 24 | 21.6~26.4 | ±5 | ±10 | ±100 | 1 | 60 | 80 |
| PDM1-S24-D9-S ^{1,*} | 24 | 21.6~26.4 | ±9 | ±6 | ±56 | 1 | 60 | 80 |
| PDM1-S24-D12-S ¹ | 24 | 21.6~26.4 | ±12 | ±5 | ±42 | 1 | 60 | 80 |
| PDM1-S24-D15-S ^{1,*} | 24 | 21.6~26.4 | ±15 | ±4 | ±34 | 1 | 60 | 80 |
| PDM1-S24-D24-S ^{1,*} | 24 | 21.6~26.4 | ±24 | ±3 | ±21 | 1 | 60 | 80 |

Notes: 1. UL approved
 2. Ripple and noise are measured at 20 MHz BW by "parallel cable" method with 1 µF ceramic and 10 µF electrolytic capacitors on the output.
 3. * Discontinued model.

PART NUMBER KEY

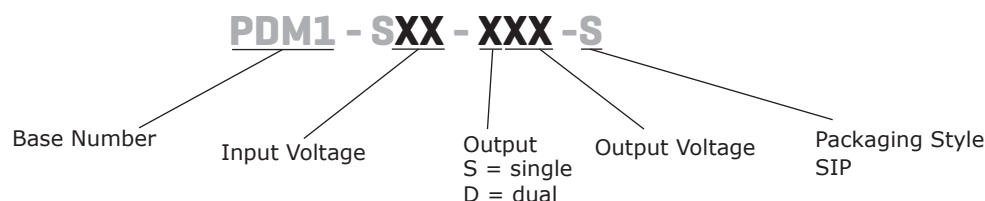

INPUT

| parameter | conditions/description | min | typ | max | units |
|-------------------------|-------------------------|------|-----|------|-------|
| operating input voltage | 3.3 Vdc input models | 2.97 | 3.3 | 3.63 | Vdc |
| | 5 Vdc input models | 4.5 | 5 | 5.5 | Vdc |
| | 9 Vdc input models | 8.1 | 9 | 9.9 | Vdc |
| | 12 Vdc input models | 10.8 | 12 | 13.2 | Vdc |
| | 15 Vdc input models | 13.5 | 15 | 16.5 | Vdc |
| | 24 Vdc input models | 21.6 | 24 | 26.4 | Vdc |
| surge voltage | for maximum of 1 second | | | | |
| | 3.3 Vdc input models | -0.7 | | 5 | Vdc |
| | 5 Vdc input models | -0.7 | | 9 | Vdc |
| | 9 Vdc input models | -0.7 | | 12 | Vdc |
| | 12 Vdc input models | -0.7 | | 18 | Vdc |
| | 15 Vdc input models | -0.7 | | 21 | Vdc |
| 24 Vdc input models | -0.7 | | 30 | Vdc | |
| filter | capacitance filter | | | | |

OUTPUT

| parameter | conditions/description | min | typ | max | units |
|-------------------------|-------------------------------------|-----|-----|-------|-------|
| line regulation | for Vin change of 1% | | | | |
| | 3.3 Vdc output models | | | ±1.5 | % |
| | all other models | | | ±1.2 | % |
| load regulation | measured from 10% load to full load | | | | |
| | 3.3 Vdc output models | | 18 | | % |
| | 5 Vdc output models | | 12 | | % |
| | 9 Vdc output models | | 9 | | % |
| | 12 Vdc output models | | 8 | | % |
| | 15 Vdc output models | | 7 | | % |
| 24 Vdc output models | | 6 | | % | |
| voltage accuracy | see tolerance envelope curve | | | | |
| switching frequency | 100% load, nominal input voltage | | 100 | | kHz |
| temperature coefficient | 100% load | | | ±0.03 | %/°C |

PROTECTIONS

| parameter | conditions/description | min | typ | max | units |
|---------------------------------------|--|-----|-----|-----|-------|
| short circuit protection ¹ | 3.3 Vdc input single output models, 24 Vdc input single/dual output models, PDM1-S5-S24-S, PDM1-S5-D24-S, PDM1-S3-D15-S all other models: continuous, auto recovery | | | 1 | s |

Notes: 1. The supply voltage must be discontinued at the end of the short circuit duration

SAFETY AND COMPLIANCE

| parameter | conditions/description | min | typ | max | units |
|-------------------------------|--|-----------|-----|-----|-------|
| isolation voltage | input to output, for 1 minute at 1 mA max. | 1,500 | | | Vdc |
| isolation resistance | input to output at 500 Vdc | 1,000 | | | MΩ |
| isolation capacitance | input to output at 100kHz/0.1V | | 20 | | pF |
| safety approvals ² | certified to 60950: EN certified to 60950-1: UL | | | | |
| conducted emissions | CISPR32/EN55032 class B (external circuit required, see Figure 1) | | | | |
| radiated emissions | CISPR32/EN55032 class B (external circuit required, see Figure 1) | | | | |
| ESD | IEC/EN61000-4-2, class B, contact ± 8kV for single outputs IEC/EN61000-4-2, class B, contact ± 6kV for dual outputs | | | | |
| MTBF | as per MIL-HDBK-217F at 25°C | 3,500,000 | | | hours |
| RoHS | yes | | | | |

Notes: 2. See specific models noted on pages 1 and 2

ENVIRONMENTAL

| parameter | conditions/description | min | typ | max | units |
|-----------------------|------------------------|-----|-----|-----|-------|
| operating temperature | see derating curve | -40 | | 105 | °C |
| storage temperature | | -55 | | 125 | °C |
| storage humidity | non-condensing | | | 95 | % |
| temperature rise | Ta = 25°C | | 25 | | °C |

SOLDERABILITY

| parameter | conditions/description | min | typ | max | units |
|----------------|---------------------------------|-----|-----|-----|-------|
| hand soldering | 1.5 mm from case for 10 seconds | | | 300 | °C |
| wave soldering | see wave soldering profile | | | 260 | °C |

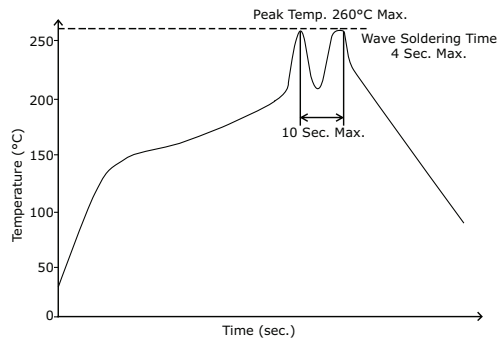

MECHANICAL

| parameter | conditions/description | min | typ | max | units |
|---------------|--|-----|-----|-----|-------|
| dimensions | 19.50 x 6.00 x 9.30 (0.768 x 0.236 x 0.366 inch) | | | | mm |
| case material | epoxy resin (UL94-V0) | | | | |
| weight | | | 2.4 | | g |

MECHANICAL DRAWING

units: mm[inch]
tolerance: ±0.25[±0.010]
pin section tolerance: ±0.10[±0.004]

| PIN CONNECTIONS | | |
|-----------------|---------------|-------------|
| PIN | Single Output | Dual Output |
| 1 | Vin | Vin |
| 2 | GND | GND |
| 4 | 0V | -Vo |
| 5 | No Pin | 0V |
| 6 | +Vo | +Vo |

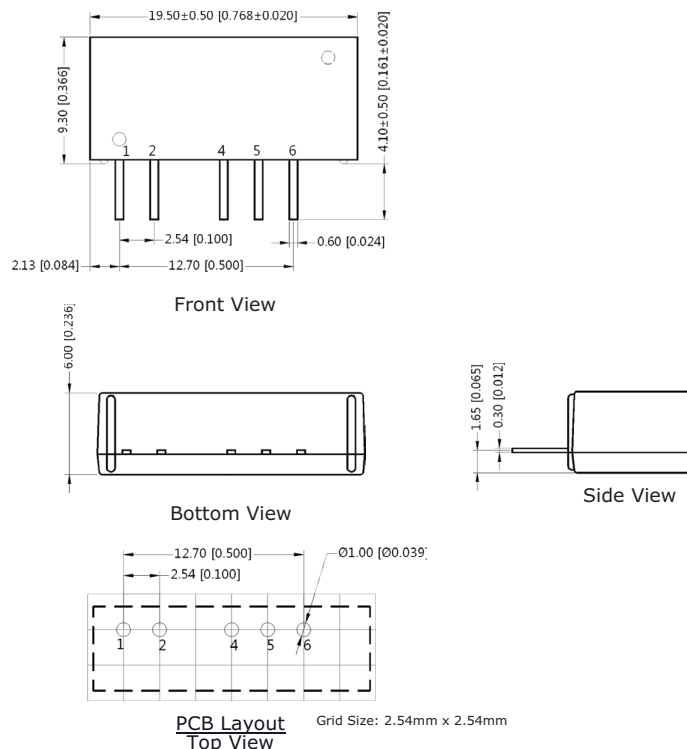

DERATING CURVES

OUTPUT REGULATION CURVE
3.3 Vdc output model
(nominal input)

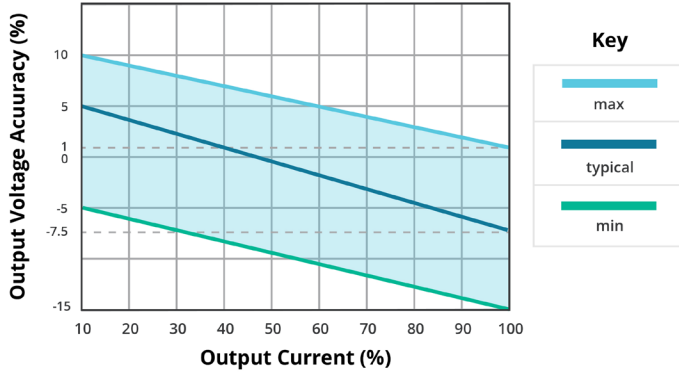

OUTPUT REGULATION CURVE
all other output models
(nominal input)

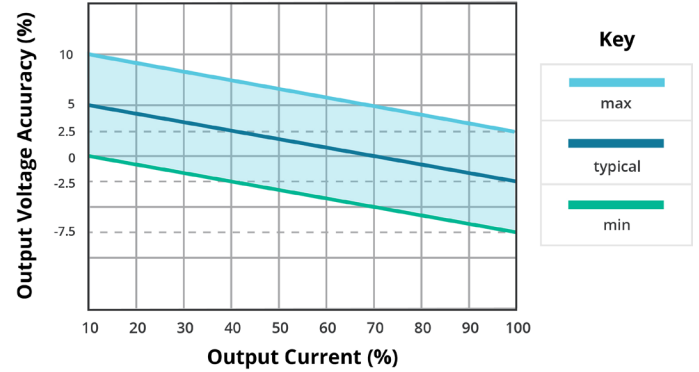

TEMPERATURE DERATING CURVE

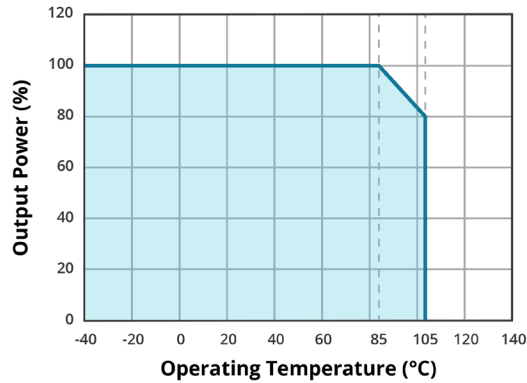

EMC RECOMMENDED CIRCUIT

Figure 1

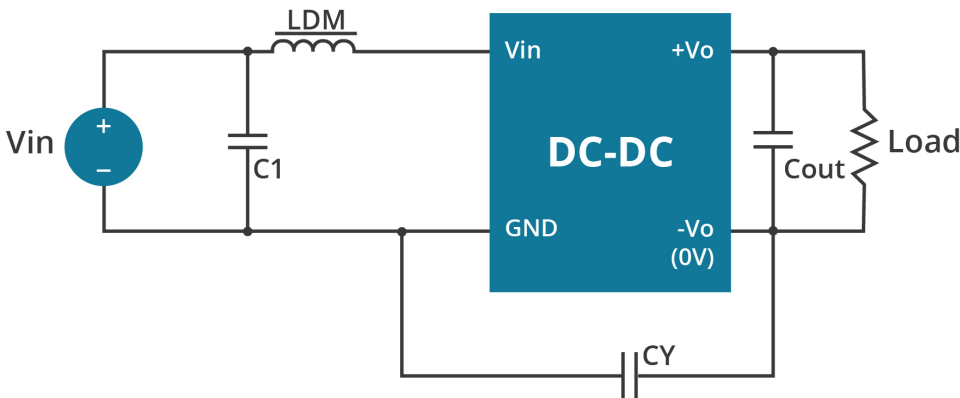

Table 1

| Recommended external circuit components | | | |
|---|-----------|---------|-------|
| Vin (Vdc) | C1 | CY | LDM |
| 3.3 | 4.7μF/50V | -- | 6.8μH |
| 5 | 4.7μF/50V | -- | 6.8μH |
| 9 | 4.7μF/50V | -- | 6.8μH |
| 12 | 4.7μF/50V | -- | 6.8μH |
| 15 | 4.7μF/50V | 1nF/2KV | 6.8μH |
| 24 | 4.7μF/50V | 1nF/2KV | 6.8μH |

Note: 1. See Table 2 for Cout values.

APPLICATION NOTES

1. Output load requirement

To ensure this module can operate efficiently and reliably, the minimum output load may not be less than 10% of the full load during operation. If the actual output power is low, connect a resistor at the output end in parallel to increase the load.

2. Recommended circuit

If you want to further decrease the input/output ripple, you can increase the capacitance accordingly or choose capacitors with low ESR (see Figure 2 & Table 2). However, the capacitance of the output filter capacitor must be appropriate. If the capacitance is too high, a startup problem might arise. For every channel of the output, to ensure safe and reliable operation, the maximum capacitance must be less than the maximum capacitive load (see Table 3).

Figure 2

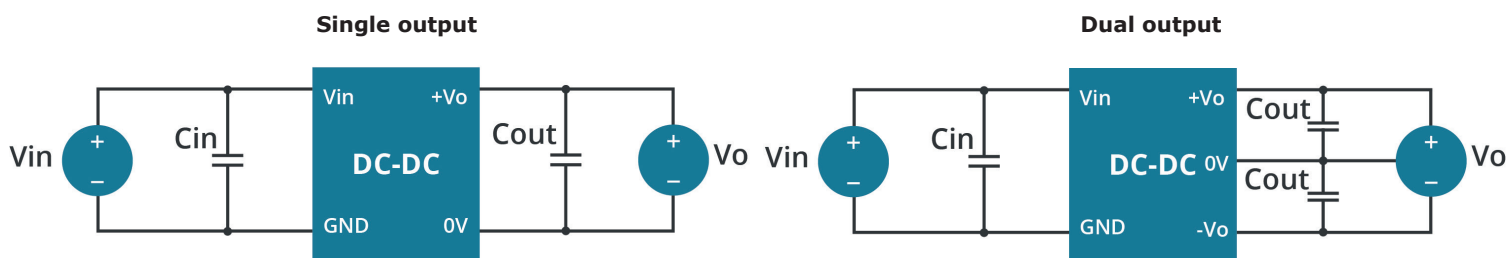

Table 2

| Vin (Vdc) | Cin (μF) | Single Vo (Vdc) | Cout (μF) | Dual Vo (Vdc) | Cout (μF) |
|-----------|----------|-----------------|-----------|---------------|-----------|
| 3.3 | 4.7 | 3.3 | 10 | ±3.3 | 4.7 |
| 5 | 4.7 | 5 | 10 | ±5 | 4.7 |
| 9 | 2.2 | 9 | 2.2 | ±9 | 1 |
| 12 | 2.2 | 12 | 2.2 | ±12 | 1 |
| 15 | 2.2 | 15 | 1 | ±15 | 0.47 |
| 24 | 1 | 24 | 1 | ±24 | 0.47 |

Note: It's not recommended to connect any external capacitors in applications with less than 0.5 watt output.

Table 3

| Single Vout (Vdc) | Max. Capacitive Load (μF) | Dual Vout (Vdc) | Max. Capacitive Load ¹ (μF) |
|-------------------|---------------------------|-----------------|--|
| 3.3 | 220 | 3.3 | 100 |
| 5 | 220 | 5 | 100 |
| 9 | 220 | 9 | 100 |
| 12 | 220 | 12 | 100 |
| 15 | 220 | 15 | 100 |
| 24 | 220 | 24 | 100 |

Note: 1. For each output.

Note: 1. Operation under minimum load will not damage the converter; however, they may not meet all specifications listed.
 2. Max. capacitive load tested at input voltage range and full load.
 3. All specifications measured at: Ta=25°C, humidity<75%, nominal input voltage and rated output load, unless otherwise specified.

REVISION HISTORY

| rev. | description | date |
|------|--|------------|
| 1.0 | initial release | 03/18/2013 |
| 1.01 | added models, added UL approval to some models | 11/14/2014 |
| 1.02 | added UL approval to some models | 02/10/2015 |
| 1.03 | updated tolerance envelope curves | 09/12/2018 |
| 1.04 | safeties updated in features and safety line | 01/18/2021 |
| 1.05 | derating curves and circuit figures updated | 07/01/2021 |
| 1.06 | CE removed | 10/27/2022 |
| 1.07 | discontinued model PDM1-S3-D5-S, PDM1-S5-D24-S, PDM1-S5-S24-S, PDM1-S9-D15-S | 12/14/2022 |
| 1.08 | discontinued model PDM1-S5-S3-S, PDM1-S5-S9-S, PDM1-S5-S12-S & PDM1-S15-S9-S | 02/02/2023 |
| 1.09 | updated safeties | 02/10/2023 |
| 1.10 | discontinued models | 06/29/2023 |

The revision history provided is for informational purposes only and is believed to be accurate.



CUI INC
a bel group

Headquarters
20050 SW 112th Ave.
Tualatin, OR 97062
800.275.4899

Fax 503.612.2383
cui.com
techsupport@cui.com

CUI offers a two (2) year limited warranty. Complete warranty information is listed on our website.

CUI reserves the right to make changes to the product at any time without notice. Information provided by CUI is believed to be accurate and reliable. However, no responsibility is assumed by CUI for its use, nor for any infringements of patents or other rights of third parties which may result from its use.

CUI products are not authorized or warranted for use as critical components in equipment that requires an extremely high level of reliability. A critical component is any component of a life support device or system whose failure to perform can be reasonably expected to cause the failure of the life support device or system, or to affect its safety or effectiveness.