

DO NOT SCALE FROM THIS PRINT

TABLE 1			
"A" RANGE	BODY STYLE (SEE NOTE 5 & 6)		FIG
	UPPER	LOWER	
.095[2.41] - .129[3.28]	FTM-XX-D	FTM-XX-D	2
.130[3.30] - .245[6.22]	FTMH-XX-D	MW-XX-D	1

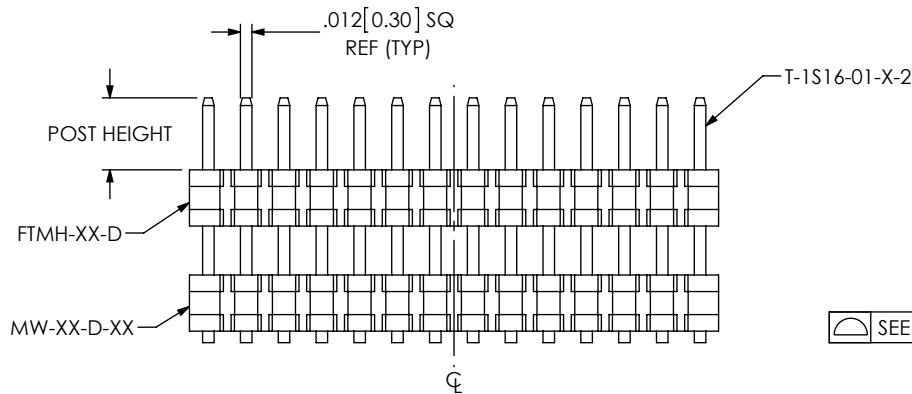
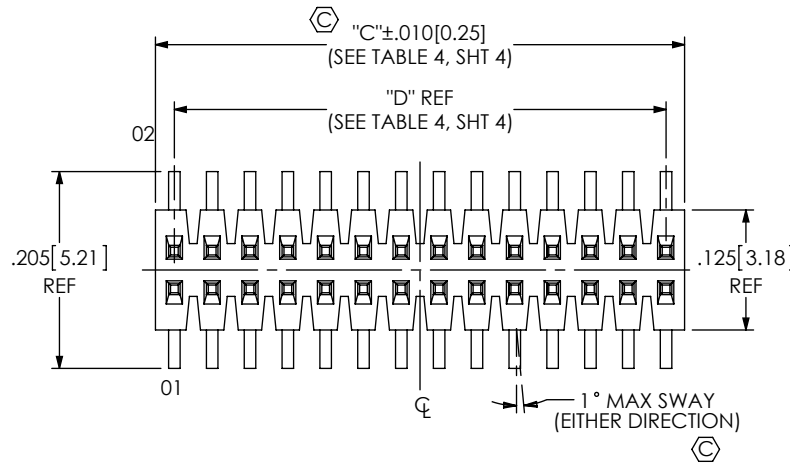

MW-XX-03-X-D-XXX-XXX-XX

No OF POSITIONS
-02 THRU -50 (PER ROW)

LEAD STYLE
USE T-1S16-01-X-2 (SEE NOTE 7)

PLATING SPECIFICATION
-F: 3μ" SELECTIVE GOLD IN CONTACT AREA, MATTE TIN ON TAIL
-L: 10μ" SELECTIVE GOLD IN CONTACT AREA, MATTE TIN ON TAIL
-G: 10μ" GOLD IN CONTACT AREA, 3μ" GOLD ON TAIL
-H: 30μ" GOLD IN CONTACT AREA, 3μ" GOLD ON TAIL

ROW SPECIFICATION
-D: DOUBLE (SEE TABLE 1 FOR BODY)

BOARD SPACE OPTION
"A": .245 [6.22] MAX w/ .065 [1.65] POST, .095 [2.41] MIN.

OPTION
-P: PICK & PLACE PAD (SEE SHT 2, FIG 3, USE PPP-30) (7 POS PER ROW MIN) (USE PPP-30-NT FOR -TR ONLY)
-ES: END SHROUDS (9 POS PER ROW MIN) (SEE SHT 2, FIG 4) (MAX POST: .075 [1.91]) (SEE NOTE 8)
-EP: GUIDE POST (9 POS PER ROW MIN) (SEE SHT 2, FIG 5) (MAX POST: .075 [1.91]) (SEE NOTE 8)
-A: ALIGNMENT PINS (MOLDED OR STAKED, SAMTEC'S DISCRETION ON WHICH)(SEE FIGS 6 & 7, SHT 3) (STAKED: 7 POS MIN, 60 POS MAX) (MOLDED: 5 POS MIN, 75 POS MAX) (SEE NOTE 8)
-TR: TAPE & REEL (ALL POSITIONS) (MAX HEIGHT: .6875)

POST HEIGHT
.065 [1.65] MIN (POST + BOARD SPACE = .310 [7.87] MAX)

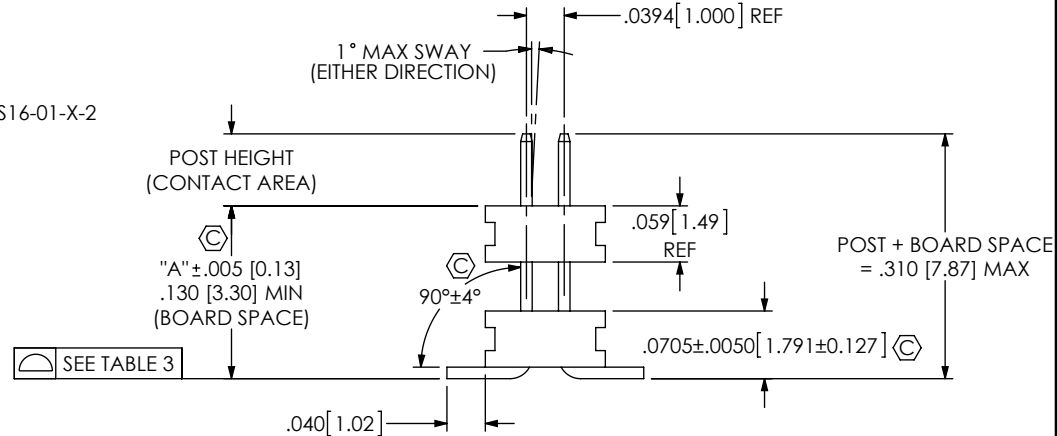

FIG 1
MW-14-03-X-D-180-075 SHOWN

- NOTES:
- ⊕ REPRESENTS A CRITICAL DIMENSION.
 - ⊕ PARTS MAY BE CUT TO POSITION; MAXIMUM CUT FLASH: .010 [0.25].
 - ⊕ SHEAR TAILS TO DIMENSION SHOWN; BURR ALLOWANCE: .003 [0.038] MAX. (FOR HAND TOOLING ONLY)
 - PACKAGE POSITIONS 05 THROUGH 50 IN TUBES; LAYER PACKAGE POSITIONS 02 THROUGH 04.
 - ⊕ HAND ASSEMBLED PARTS TO BE 2 BLACK BODIES AND MACHINE ASSEMBLED TO BE TOP: BLACK; BOTTOM: NATURAL, BOARD SPACE .130-245. BOARD SPACE .095-.129 WILL HAVE BLACK FTM BODY
 - FOR HAND FILL, USE FTMH-XX-D FOR LOWER BODY.
 - FOR MACHINE FILLED, USE T-1S16-03-X-2.
 - AVAILABLE ONLY WITH BOARD SPACE .130 TO .245.
 - 75 POSITION AVAILABLE FOR SAMTEC INVENTORY ONLY.
 - FOR ADDED MECHANICAL STABILITY, SAMTEC RECOMMENDS MECHANICAL BOARD SPACERS BE USED IN APPLICATIONS WITH GOLD OR SELECTIVE GOLD PLATED CONNECTORS. CONTACT IPG@SAMTEC.COM FOR MORE INFORMATION.

TABLE 3	
No. OF POS	"A"
02-30 POS	.004 [0.10]
31-50 POS	.006 [0.15]

<p>UNLESS OTHERWISE SPECIFIED, DIMENSIONS ARE IN INCHES.</p> <p>TOLERANCES ARE:</p> <table border="0"> <tr> <td>DECIMALS</td> <td>ANGLES</td> </tr> <tr> <td>.XX: ±.01 [0.3]</td> <td>2°</td> </tr> <tr> <td>.XXX: ±.005 [0.13]</td> <td></td> </tr> <tr> <td>.XXXX: ±.0020 [0.051]</td> <td></td> </tr> </table>	DECIMALS	ANGLES	.XX: ±.01 [0.3]	2°	.XXX: ±.005 [0.13]		.XXXX: ±.0020 [0.051]		<p>PROPRIETARY NOTE</p> <p>THIS DOCUMENT CONTAINS CONFIDENTIAL AND PROPRIETARY INFORMATION AND ALL DESIGN, MANUFACTURING, REPRODUCTION, USE, PATENT RIGHTS AND SALES RIGHTS ARE EXPRESSLY RESERVED BY SAMTEC, INC. THIS DOCUMENT SHALL NOT BE DISCLOSED, IN WHOLE OR PART, TO ANY UNAUTHORIZED PERSON OR ENTITY NOR REPRODUCED, TRANSFERRED OR INCORPORATED IN ANY OTHER PROJECT IN ANY MANNER WITHOUT THE EXPRESS WRITTEN CONSENT OF SAMTEC, INC.</p>	<p>520 PARK EAST BLVD, NEW ALBANY, IN 47150 PHONE: 812-944-6733 FAX: 812-948-5047 e-Mail: info@SAMTEC.com code 55322</p>
	DECIMALS	ANGLES								
.XX: ±.01 [0.3]	2°									
.XXX: ±.005 [0.13]										
.XXXX: ±.0020 [0.051]										
<p>MATERIAL: DO NOT SCALE DRAWING SHEET SCALE: 5:1</p> <p>INSULATOR: LCP; FTM-XX-D & FTMH-XX-D COLOR: BLACK MW-XX-D-XX COLOR: NATURAL</p> <p>TERMINAL: PHOS BRONZE</p> <p>MAX FLASH ALLOWED: .002 [0.05] MAX GATE VESTIGE: .002 [0.05]</p>	<p>DESCRIPTION: 1mm x 1mm SM BOARD STACKER ASSEMBLY</p> <p>DWG. NO. MW-XX-03-X-D-XXX-XXX-XX</p> <p>BY: BRATCHER 4/3/1995 SHEET 1 OF 4</p>									

REVISION AT

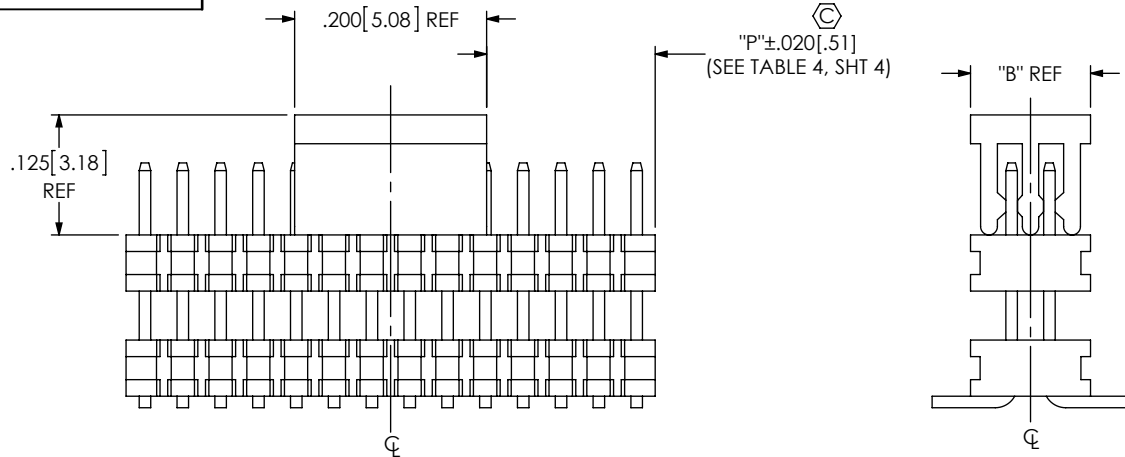

FIG 3
MW-14-03-X-D-180-075-P SHOWN
(DIFFERENT AS SHOWN, OTHERWISE SAME AS FIG 1)

TABLE 2	
PART NO	"B"
PPP-30	.125 [3.18]
PPP-30-NT	.190 [4.83]

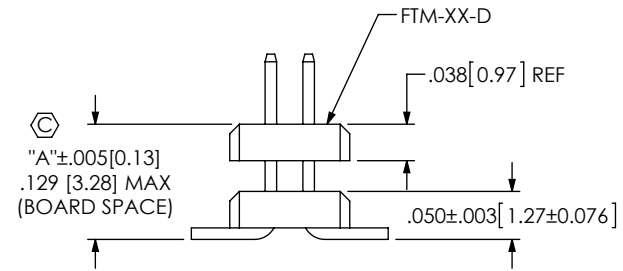

FIG 2
MW-10-03-X-D-120-073 SHOWN
(DIFFERENT AS SHOWN, OTHERWISE SAME AS FIG 1)

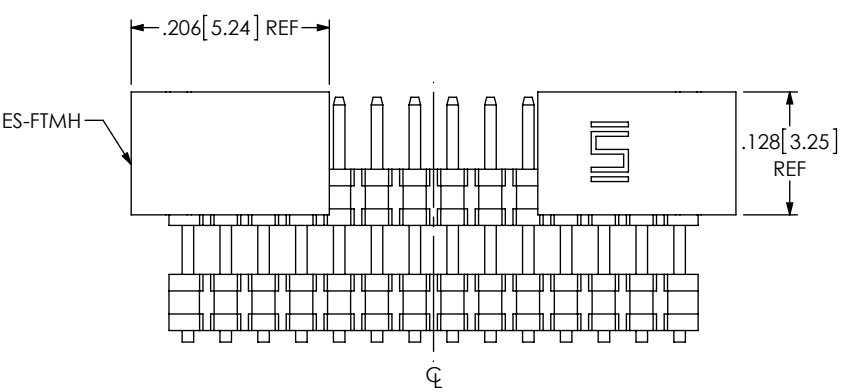
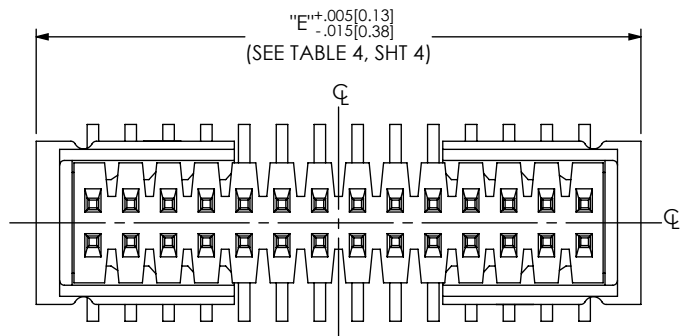
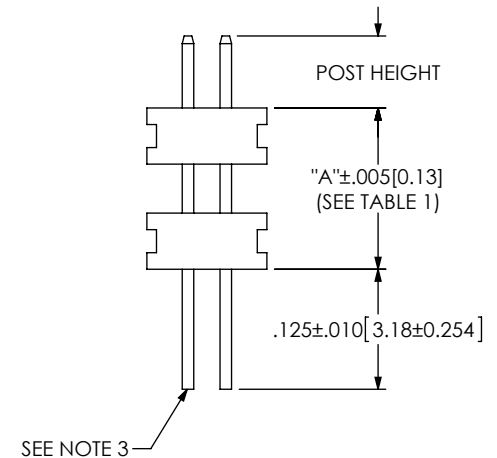
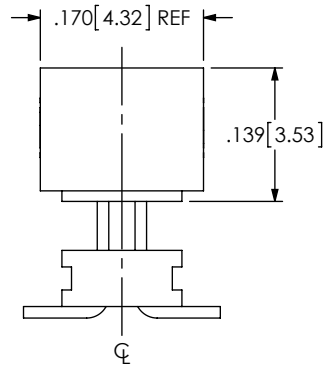

FIG 4
MW-14-03-X-D-180-075-ES SHOWN
(DIFFERENT AS SHOWN, OTHERWISE SAME AS FIG 1)



IN-PROCESS
*FOR HAND TOOLING ONLY

PROPRIETARY NOTE
THIS DOCUMENT CONTAINS CONFIDENTIAL AND PROPRIETARY INFORMATION AND ALL DESIGN, MANUFACTURING, REPRODUCTION, USE, PATENT RIGHTS AND SALES RIGHTS ARE EXPRESSLY RESERVED BY SAMTEC, INC. THIS DOCUMENT SHALL NOT BE DISCLOSED, IN WHOLE OR PART, TO ANY UNAUTHORIZED PERSON OR ENTITY NOR REPRODUCED, TRANSFERRED OR INCORPORATED IN ANY OTHER PROJECT IN ANY MANNER WITHOUT THE EXPRESS WRITTEN CONSENT OF SAMTEC, INC.

DO NOT SCALE DRAWING
SHEET SCALE: 5:1



520 PARK EAST BLVD. NEW ALBANY, IN 47150
PHONE: 812-944-6733 FAX: 812-948-5047
e-Mail info@SAMTEC.com code 55322

DESCRIPTION:
1mm x 1mm SM BOARD STACKER ASSEMBLY
DWG. NO.
MW-XX-03-X-D-XXX-XXX-XX
BY: BRATCHER 4/3/1995 SHEET 2 OF 4

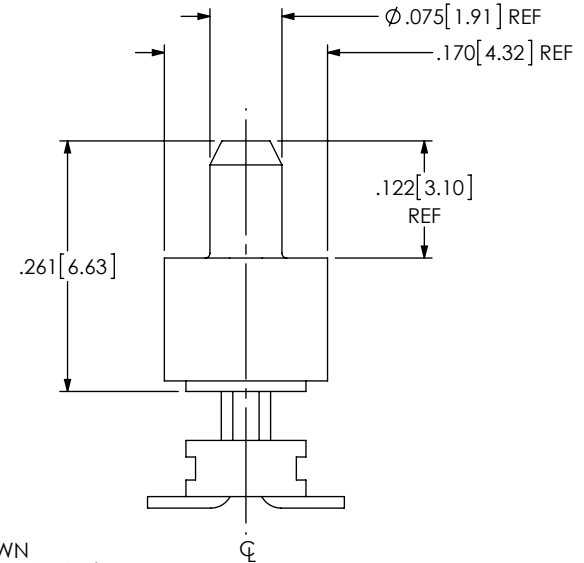
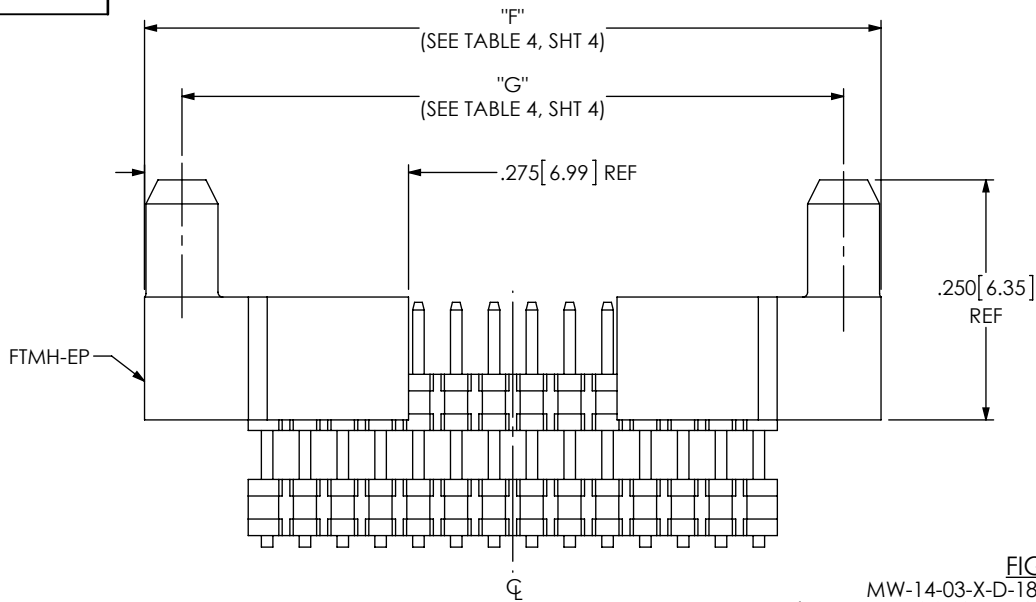

FIG 5
MW-14-03-X-D-180-075-EP SHOWN
(DIFFERENT AS SHOWN, OTHERWISE SAME AS FIG 1)

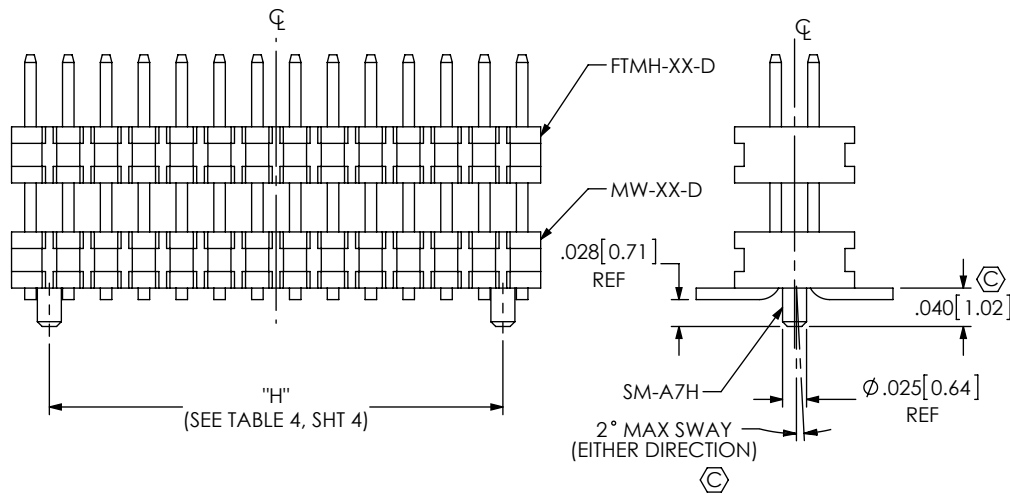

FIG 6
STAKED -A OPTION
MW-14-03-X-D-180-075-A SHOWN
(60 POSITION MAX)
(DIFFERENT AS SHOWN, OTHERWISE SAME AS FIG 1)

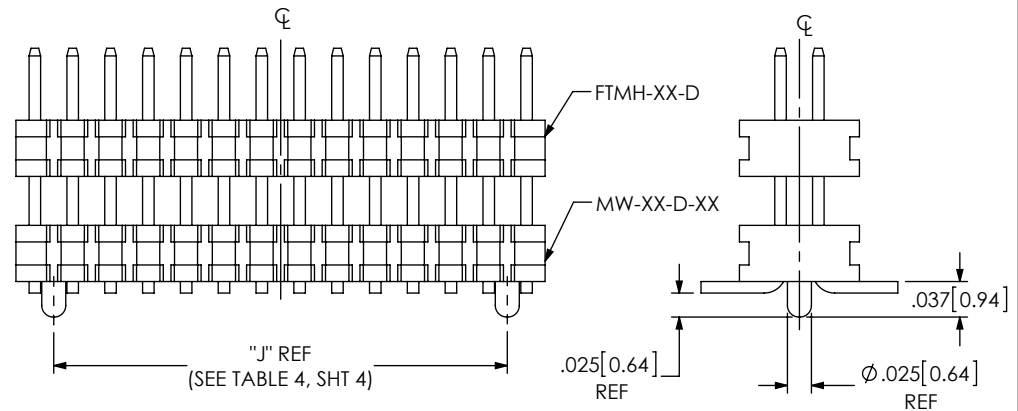

FIG 7
MOLDED -A OPTION
MW-14-03-X-D-180-075-A SHOWN
(75 POSITION MAX)
(DIFFERENT AS SHOWN, OTHERWISE SAME AS FIG 1)

PROPRIETARY NOTE
THIS DOCUMENT CONTAINS CONFIDENTIAL AND PROPRIETARY INFORMATION AND ALL DESIGN, MANUFACTURING, REPRODUCTION, USE, PATENT RIGHTS AND SALES RIGHTS ARE EXPRESSLY RESERVED BY SAMTEC, INC. THIS DOCUMENT SHALL NOT BE DISCLOSED, IN WHOLE OR IN PART, TO ANY UNAUTHORIZED PERSON OR ENTITY NOR REPRODUCED, TRANSFERRED OR INCORPORATED IN ANY OTHER PROJECT IN ANY MANNER WITHOUT THE EXPRESS WRITTEN CONSENT OF SAMTEC, INC.

DO NOT SCALE DRAWING

SHEET SCALE: 5:1

samtec

520 PARK EAST BLVD. NEW ALBANY, IN 47150
PHONE: 812-944-6733 FAX: 812-948-5047
e-Mail info@SAMTEC.com code 55322

DESCRIPTION:
1mm x 1mm SM BOARD STACKER ASSEMBLY

DWG. NO.
MW-XX-03-X-D-XXX-XXX-XX

BY: BRATCHER 4/3/1995 SHEET 3 OF 4

REVISION AT

PT-1-24-02-60
TP-03

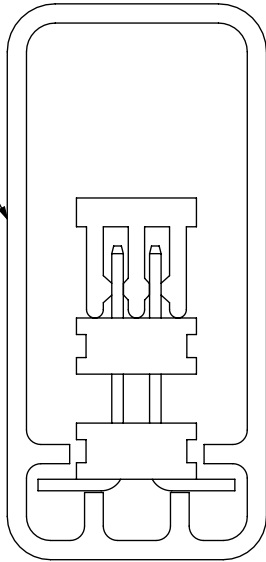

PACKAGING VIEW

No. OF POS	TABLE 4							
	"C"	"D"	"E"	"F"	"G"	"H"	"J"	"P"
02	.079 [2.00]	.039 [1.00]	N/A	N/A	N/A	N/A	N/A	N/A
03	.118 [3.00]	.079 [2.00]	N/A	N/A	N/A	N/A	N/A	N/A
04	.157 [4.00]	.118 [3.00]	N/A	N/A	N/A	N/A	N/A	N/A
05	.197 [5.00]	.157 [4.00]	N/A	N/A	N/A	N/A	.118 [3.00]	N/A
06	.236 [6.00]	.197 [5.00]	N/A	N/A	N/A	N/A	.157 [4.00]	N/A
07	.276 [7.00]	.236 [6.00]	N/A	N/A	N/A	.197 [5.00]	.197 [5.00]	.038 [0.96]
08	.315 [8.00]	.276 [7.00]	N/A	N/A	N/A	.236 [6.00]	.236 [6.00]	.057 [1.46]
09	.354 [9.00]	.315 [8.00]	.433 [11.00]	.570 [14.48]	.491 [12.47]	.276 [7.00]	.276 [7.00]	.077 [1.96]
10	.394 [10.00]	.354 [9.00]	.472 [12.00]	.609 [15.48]	.530 [13.47]	.315 [8.00]	.315 [8.00]	.097 [2.46]
11	.433 [11.00]	.394 [10.00]	.512 [13.00]	.649 [16.48]	.570 [14.47]	.354 [9.00]	.354 [9.00]	.117 [2.96]
12	.472 [12.00]	.433 [11.00]	.551 [14.00]	.688 [17.48]	.609 [15.47]	.394 [10.00]	.394 [10.00]	.136 [3.46]
13	.512 [13.00]	.472 [12.00]	.591 [15.00]	.728 [18.48]	.648 [16.47]	.433 [11.00]	.433 [11.00]	.156 [3.96]
14	.551 [14.00]	.512 [13.00]	.630 [16.00]	.767 [19.48]	.688 [17.47]	.472 [12.00]	.472 [12.00]	.176 [4.46]
15	.591 [15.00]	.551 [14.00]	.669 [17.00]	.806 [20.48]	.727 [18.47]	.512 [13.00]	.512 [13.00]	.195 [4.96]
16	.630 [16.00]	.591 [15.00]	.709 [18.00]	.846 [21.48]	.767 [19.47]	.551 [14.00]	.551 [14.00]	.215 [5.46]
17	.669 [17.00]	.630 [16.00]	.748 [19.00]	.885 [22.48]	.806 [20.47]	.591 [15.00]	.591 [15.00]	.235 [5.96]
18	.709 [18.00]	.669 [17.00]	.787 [20.00]	.924 [23.48]	.845 [21.47]	.630 [16.00]	.630 [16.00]	.254 [6.46]
19	.748 [19.00]	.709 [18.00]	.827 [21.00]	.964 [24.48]	.885 [22.47]	.669 [17.00]	.669 [17.00]	.274 [6.96]
20	.787 [20.00]	.748 [19.00]	.866 [22.00]	1.003 [25.48]	.924 [23.47]	.709 [18.00]	.709 [18.00]	.294 [7.46]
21	.827 [21.00]	.787 [20.00]	.906 [23.00]	1.043 [26.48]	.963 [24.47]	.748 [19.00]	.748 [19.00]	.313 [7.96]
22	.866 [22.00]	.827 [21.00]	.945 [24.00]	1.082 [27.48]	1.003 [25.47]	.787 [20.00]	.787 [20.00]	.333 [8.46]
23	.906 [23.00]	.866 [22.00]	.984 [25.00]	1.121 [28.48]	1.042 [26.47]	.827 [21.00]	.827 [21.00]	.353 [8.96]
24	.945 [24.00]	.906 [23.00]	1.024 [26.00]	1.161 [29.48]	1.081 [27.47]	.866 [22.00]	.866 [22.00]	.372 [9.46]
25	.984 [25.00]	.945 [24.00]	1.063 [27.00]	1.200 [30.48]	1.121 [28.47]	.906 [23.00]	.906 [23.00]	.392 [9.96]
26	1.024 [26.00]	.984 [25.00]	1.102 [28.00]	1.239 [31.48]	1.160 [29.47]	.945 [24.00]	.945 [24.00]	.412 [10.46]
27	1.063 [27.00]	1.024 [26.00]	1.142 [29.00]	1.279 [32.48]	1.200 [30.47]	.984 [25.00]	.984 [25.00]	.431 [10.96]
28	1.102 [28.00]	1.063 [27.00]	1.181 [30.00]	1.318 [33.48]	1.239 [31.47]	1.024 [26.00]	1.024 [26.00]	.451 [11.46]
29	1.142 [29.00]	1.102 [28.00]	1.220 [31.00]	1.357 [34.48]	1.278 [32.47]	1.063 [27.00]	1.063 [27.00]	.471 [11.96]
30	1.181 [30.00]	1.142 [29.00]	1.260 [32.00]	1.397 [35.48]	1.318 [33.47]	1.102 [28.00]	1.102 [28.00]	.491 [12.46]
31	1.220 [31.00]	1.181 [30.00]	1.299 [33.00]	1.436 [36.48]	1.357 [34.47]	1.142 [29.00]	1.142 [29.00]	.510 [12.96]
32	1.260 [32.00]	1.220 [31.00]	1.339 [34.00]	1.476 [37.48]	1.396 [35.47]	1.181 [30.00]	1.181 [30.00]	.530 [13.46]
33	1.299 [33.00]	1.260 [32.00]	1.378 [35.00]	1.515 [38.48]	1.436 [36.47]	1.220 [31.00]	1.220 [31.00]	.550 [13.96]
34	1.339 [34.00]	1.299 [33.00]	1.417 [36.00]	1.554 [39.48]	1.475 [37.47]	1.260 [32.00]	1.260 [32.00]	.569 [14.46]
35	1.378 [35.00]	1.339 [34.00]	1.457 [37.00]	1.594 [40.48]	1.515 [38.47]	1.299 [33.00]	1.299 [33.00]	.589 [14.96]
36	1.417 [36.00]	1.378 [35.00]	1.496 [38.00]	1.633 [41.48]	1.554 [39.47]	1.339 [34.00]	1.339 [34.00]	.609 [15.46]
37	1.457 [37.00]	1.417 [36.00]	1.535 [39.00]	1.672 [42.48]	1.593 [40.47]	1.378 [35.00]	1.378 [35.00]	.628 [15.96]
38	1.496 [38.00]	1.457 [37.00]	1.575 [40.00]	1.712 [43.48]	1.633 [41.47]	1.417 [36.00]	1.417 [36.00]	.648 [16.46]
39	1.535 [39.00]	1.496 [38.00]	1.614 [41.00]	1.751 [44.48]	1.672 [42.47]	1.457 [37.00]	1.457 [37.00]	.668 [16.96]
40	1.575 [40.00]	1.535 [39.00]	1.654 [42.00]	1.791 [45.48]	1.711 [43.47]	1.496 [38.00]	1.496 [38.00]	.687 [17.46]
41	1.614 [41.00]	1.575 [40.00]	1.693 [43.00]	1.830 [46.48]	1.751 [44.47]	1.535 [39.00]	1.535 [39.00]	.707 [17.96]
42	1.654 [42.00]	1.614 [41.00]	1.732 [44.00]	1.869 [47.48]	1.790 [45.47]	1.575 [40.00]	1.575 [40.00]	.727 [18.46]
43	1.693 [43.00]	1.654 [42.00]	1.772 [45.00]	1.909 [48.48]	1.830 [46.47]	1.614 [41.00]	1.614 [41.00]	.746 [18.96]
44	1.732 [44.00]	1.693 [43.00]	1.811 [46.00]	1.948 [49.48]	1.869 [47.47]	1.654 [42.00]	1.654 [42.00]	.766 [19.46]
45	1.772 [45.00]	1.732 [44.00]	1.850 [47.00]	1.987 [50.48]	1.908 [48.47]	1.693 [43.00]	1.693 [43.00]	.786 [19.96]
46	1.811 [46.00]	1.772 [45.00]	1.890 [48.00]	2.027 [51.48]	1.948 [49.47]	1.732 [44.00]	1.732 [44.00]	.806 [20.46]
47	1.850 [47.00]	1.811 [46.00]	1.929 [49.00]	2.066 [52.48]	1.987 [50.47]	1.772 [45.00]	1.772 [45.00]	.825 [20.96]
48	1.890 [48.00]	1.850 [47.00]	1.969 [50.00]	2.106 [53.48]	2.026 [51.47]	1.811 [46.00]	1.811 [46.00]	.845 [21.46]
49	1.929 [49.00]	1.890 [48.00]	2.008 [51.00]	2.145 [54.48]	2.066 [52.47]	1.850 [47.00]	1.850 [47.00]	.865 [21.96]
50	1.969 [50.00]	1.929 [49.00]	2.047 [52.00]	2.184 [55.48]	2.105 [53.47]	1.890 [48.00]	1.890 [48.00]	.884 [22.46]

PROPRIETARY NOTE
 THIS DOCUMENT CONTAINS CONFIDENTIAL AND PROPRIETARY INFORMATION AND ALL DESIGN, MANUFACTURING, REPRODUCTION, USE, PATENT RIGHTS AND SALES RIGHTS ARE EXPRESSLY RESERVED BY SAMTEC, INC. THIS DOCUMENT SHALL NOT BE DISCLOSED, IN WHOLE OR PART, TO ANY UNAUTHORIZED PERSON OR ENTITY NOR REPRODUCED, TRANSFERRED OR INCORPORATED IN ANY OTHER PROJECT IN ANY MANNER WITHOUT THE EXPRESS WRITTEN CONSENT OF SAMTEC, INC.

DO NOT SCALE DRAWING

SHEET SCALE: 5:1



520 PARK EAST BLVD, NEW ALBANY, IN 47150
 PHONE: 812-944-6733 FAX: 812-948-5047
 e-Mail info@SAMTEC.com code 55322

DESCRIPTION:
 1mm x 1mm SM BOARD STACKER ASSEMBLY

DWG. NO.
MW-XX-03-X-D-XXX-XXX-XX

BY: BRATCHER 4/3/1995 SHEET 4 OF 4