

MAX6018

Precision, Micropower, 1.8V Supply, Low-Dropout, SOT23 Voltage Reference

General Description

The MAX6018 is a precision, low-voltage, low-dropout, micropower voltage reference in a SOT23 package. This three-terminal reference operates with an input voltage from ($V_{OUT} + 200\text{mV}$) to 5.5V, and is available with output voltage options of 1.2V, 1.6V, 1.8V, and 2.048V

The MAX6018 voltage reference consumes less than 5 μA (max) of supply current and can source and sink up to 1mA of load current. Unlike conventional shunt-mode (two-terminal) references that waste supply current and require an external resistor, devices in the MAX6018 family offer a supply current that is virtually independent of supply voltage (with only 0.1 $\mu\text{A/V}$ variation with supply voltage) and do not require an external resistor. The MAX6018 has initial accuracies of 0.2% (A grade) and 0.4% (B grade) and temperature drift of 50ppm/ $^{\circ}\text{C}$ (max). The low-dropout voltage and the ultra-low, supply voltage-independent supply current make this device ideal for two-cell alkaline, end-of-life, battery-monitoring systems. The MAX6018 is available in a tiny 3-pin SOT23 package.

Applications

- Two-Cell, Battery-Operated Systems
- Battery-Operated Equipment
- Hand-Held Equipment
- Data-Acquisition Systems
- Industrial and Process-Control Systems

Typical Application Circuit

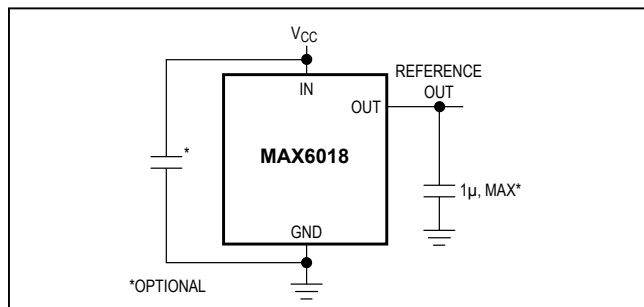

Pin Configuration

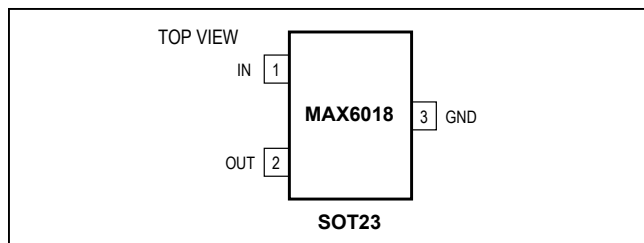

Benefits and Features

- Ultra-Low Supply Current: 5 μA (max)
- 1.6V Output from 1.8V Input
- Ultra-Small, 3-Pin SOT23 Package
- Initial Accuracy: $\pm 0.2\%$ (max)
- Low Temperature Drift: 50ppm/ $^{\circ}\text{C}$ (max)
- 200mV Dropout Voltage
- Load Regulation (1mA Source): 700 $\mu\text{V}/\text{mA}$ (max)
- Line Regulation ($V_{OUT} + 200\text{mV}$) to 5.5V: 250 $\mu\text{V}/\text{V}$ (max)
- Four Output Voltage Options: 1.2V, 1.6V, 1.8V, 2.048V

Ordering Information

| PART | TEMP RANGE | PIN-PACKAGE | TOP MARK |
|-----------------|--|-------------|----------|
| MAX6018AEUR12+T | -40 $^{\circ}\text{C}$ to +85 $^{\circ}\text{C}$ | 3 SOT23-3 | FZJH |
| MAX6018BEUR12+T | -40 $^{\circ}\text{C}$ to +85 $^{\circ}\text{C}$ | 3 SOT23-3 | FZJI |
| MAX6018AEUR16+T | -40 $^{\circ}\text{C}$ to +85 $^{\circ}\text{C}$ | 3 SOT23-3 | FZJJ |
| MAX6018BEUR16+T | -40 $^{\circ}\text{C}$ to +85 $^{\circ}\text{C}$ | 3 SOT23-3 | FZJK |
| MAX6018AEUR18+T | -40 $^{\circ}\text{C}$ to +85 $^{\circ}\text{C}$ | 3 SOT23-3 | FZJL |
| MAX6018BEUR18+T | -40 $^{\circ}\text{C}$ to +85 $^{\circ}\text{C}$ | 3 SOT23-3 | FZJM |
| MAX6018AEUR21+T | -40 $^{\circ}\text{C}$ to +85 $^{\circ}\text{C}$ | 3 SOT23-3 | FZJN |
| MAX6018BEUR21+T | -40 $^{\circ}\text{C}$ to +85 $^{\circ}\text{C}$ | 3 SOT23-3 | FZJO |

Selector Guide

| PART | OUTPUT VOLTAGE (V) | INITIAL ACCURACY (%) |
|---------------|--------------------|----------------------|
| MAX6018AEUR12 | 1.263 | ± 0.2 |
| MAX6018BEUR12 | 1.263 | ± 0.4 |
| MAX6018AEUR16 | 1.600 | ± 0.2 |
| MAX6018BEUR16 | 1.600 | ± 0.4 |
| MAX6018AEUR18 | 1.800 | ± 0.2 |
| MAX6018BEUR18 | 1.800 | ± 0.4 |
| MAX6018AEUR21 | 2.048 | ± 0.2 |
| MAX6018BEUR21 | 2.048 | ± 0.4 |

MAX6018

Precision, Micropower, 1.8V Supply, Low-Dropout, SOT23 Voltage Reference

Absolute Maximum Ratings

(Voltages Referenced to GND)

V_{IN} -0.3V to +6V
 Output Short-Circuit Duration to GND or V_{IN} Continuous
 Continuous Power Dissipation ($T_A = +70^\circ\text{C}$)
 3-Pin SOT23 (derate 4.0mW/°C above +70°C) 320mW

Operating Temperature Range -40°C to +85°C
 Junction Temperature +150°C
 Storage Temperature Range -65°C to +150°C
 Lead Temperature (soldering, 10s) +300°C

Stresses beyond those listed under "Absolute Maximum Ratings" may cause permanent damage to the device. These are stress ratings only, and functional operation of the device at these or any other conditions beyond those indicated in the operational sections of the specifications is not implied. Exposure to absolute maximum rating conditions for extended periods may affect device reliability.

Electrical Characteristics (MAX6018_12–1.263V)

($V_{IN} = 1.8\text{V}$; $C_{OUT} = 47\text{nF}$, $I_{OUT} = 0$; $T_A = T_{MIN}$ to T_{MAX} , unless otherwise noted. Typical values are at $T_A = +25^\circ\text{C}$.) (Note 1)

| PARAMETER | SYMBOL | CONDITIONS | MIN | TYP | MAX | UNITS |
|--|---|--|--------|--------|--------|---------------------------|
| OUTPUT | | | | | | |
| Output Voltage | V_{OUT} | MAX6018A_12 (0.2%) | 1.2605 | 1.2630 | 1.2655 | V |
| | | MAX6018B_12 (0.4%) | 1.2580 | 1.2630 | 1.2681 | |
| Output Voltage Temperature Drift | TCV_{OUT} | (Note 2) | | 16 | 50 | ppm/°C |
| Line Regulation | $\frac{\Delta V_{OUT}}{\Delta V_{IN}}$ | $1.8\text{V} \leq V_{IN} \leq 5.5\text{V}$ | | 50 | 400 | $\mu\text{V/V}$ |
| Load Regulation | $\frac{\Delta V_{OUT}}{\Delta I_{OUT}}$ | $0 \leq I_{OUT} \leq 1\text{mA}$ | | 90 | 700 | $\mu\text{V/mA}$ |
| | | $-100\mu\text{A} \leq I_{OUT} \leq 0$ | | 2 | 9 | $\mu\text{V}/\mu\text{A}$ |
| Short-Circuit Current | I_{SC} | Sourcing to GND | | 3 | | mA |
| | | Sinking from V_{IN} | | 6 | | |
| Long-Term Stability | $\frac{\Delta V_{OUT}}{\text{Time}}$ | 1000hrs at $T_A = +25^\circ\text{C}$ | | 100 | | ppm |
| Thermal Hysteresis | | (Note 4) | | 130 | | ppm |
| DYNAMIC CHARACTERISTICS | | | | | | |
| Noise Voltage | e_{OUT} | 0.1Hz to 10Hz | | 45 | | μV_{p-p} |
| | | 10Hz to 10kHz | | 100 | | μV_{RMS} |
| Ripple Rejection | | $V_{IN} = 1.8\text{V} \pm 100\text{mV}$ ($f = 120\text{Hz}$) | | 85 | | dB |
| Turn-On Settling Time | t_R | Settling to 0.1%; $C_{OUT} = 5\text{nF}$ | | 200 | | μs |
| Capacitive-Load Stability Range | C_{OUT} | (Note 2) | 47 | | 1000 | nF |
| INPUT | | | | | | |
| Supply Voltage Range | V_{IN} | Guaranteed by Line Regulation Test | 1.8 | | 5.5 | V |
| Quiescent Supply Current | I_{IN} | $T_A = +25^\circ\text{C}$ | | 3 | 5 | μA |
| | | $T_A = T_{MIN}$ to T_{MAX} | | 3 | 6 | |
| Change in Quiescent Supply Current vs. Input Voltage | $\frac{\Delta I_{IN}}{\Delta V_{IN}}$ | $1.8\text{V} \leq V_{IN} \leq 5.5\text{V}$ | | 0.1 | 0.5 | $\mu\text{A/V}$ |

Electrical Characteristics (MAX6018_16–1.600V)(V_{IN} = 1.8V; C_{OUT} = 47nF, I_{OUT} = 0; T_A = T_{MIN} to T_{MAX}, unless otherwise noted. Typical values are at T_A = +25°C.) (Note 1)

| PARAMETER | SYMBOL | CONDITIONS | MIN | TYP | MAX | UNITS | |
|--|---|---|------------------------|--------|--------|-------------------|---|
| OUTPUT | | | | | | | |
| Output Voltage | V _{OUT} | MAX6018A_16 (0.2%) | T _A = +25°C | 1.5968 | 1.6000 | 1.6032 | V |
| | | MAX6018B_16 (0.4%) | T _A = +25°C | 1.5936 | 1.6000 | 1.6064 | |
| Output Voltage Temperature Drift | TCV _{OUT} | (Note 2) | | 16 | 50 | ppm/°C | |
| Line Regulation | $\frac{\Delta V_{OUT}}{\Delta V_{IN}}$ | 1.8V ≤ V _{IN} ≤ 5.5V | | 40 | 250 | μV/V | |
| Load Regulation | $\frac{\Delta V_{OUT}}{\Delta I_{OUT}}$ | 0 ≤ I _{OUT} ≤ 1mA | | 90 | 700 | μV/mA | |
| | | -750μA ≤ I _{OUT} ≤ 0 | | 0.6 | 50 | μV/μA | |
| Dropout Voltage (Note 3) | V _{IN} - V _{OUT} | I _{OUT} = 1mA | | 100 | 200 | mV | |
| Short-Circuit Current | I _{SC} | Sourcing to GND | | 6 | | mA | |
| | | Sinking from V _{IN} | | 2 | | | |
| Long-Term Stability | $\frac{\Delta V_{OUT}}{\text{Time}}$ | 1000hrs at T _A = +25°C | | 100 | | ppm | |
| Thermal Hysteresis | | (Note 4) | | 130 | | ppm | |
| DYNAMIC CHARACTERISTICS | | | | | | | |
| Noise Voltage | e _{OUT} | 0.1Hz to 10Hz | | 40 | | μV _{p-p} | |
| | | 10Hz to 10kHz | | 150 | | μV _{RMS} | |
| Ripple Rejection | | V _{IN} = 1.8V ±100mV (f = 120Hz) | | 85 | | dB | |
| Turn-On Settling Time | t _R | Settling to 0.1%; C _{OUT} = 5nF | | 200 | | μs | |
| Capacitive-Load Stability Range | C _{OUT} | (Note 2) | 0.1 | | 1000 | nF | |
| INPUT | | | | | | | |
| Supply Voltage Range | V _{IN} | Guaranteed by Line Regulation Test | 1.8 | | 5.5 | V | |
| Quiescent Supply Current | I _{IN} | T _A = +25°C | | 3 | 5 | μA | |
| | | T _A = T _{MIN} to T _{MAX} | | 3 | 6 | | |
| Change in Quiescent Supply Current vs. Input Voltage | $\Delta I_{IN}/\Delta V_{IN}$ | 1.8V ≤ V _{IN} ≤ 5.5V | | 0.1 | 0.5 | μA/V | |

Electrical Characteristics (MAX6018_18–1.800V)(V_{IN} = 2.0V; C_{OUT} = 47nF, I_{OUT} = 0; T_A = T_{MIN} to T_{MAX}, unless otherwise noted. Typical values are at T_A = +25°C.) (Note 1)

| PARAMETER | SYMBOL | CONDITIONS | MIN | TYP | MAX | UNITS | |
|--|---|---|------------------------|--------|--------|-------------------|---|
| OUTPUT | | | | | | | |
| Output Voltage | V _{OUT} | MAX6018A_18 (0.2%) | T _A = +25°C | 1.7964 | 1.8000 | 1.8036 | V |
| | | MAX6018B_18 (0.4%) | T _A = +25°C | 1.7928 | 1.8000 | 1.8072 | |
| Output Voltage Temperature Drift | TCV _{OUT} | (Note 2) | | 16 | 50 | ppm/°C | |
| Line Regulation | $\frac{\Delta V_{OUT}}{\Delta V_{IN}}$ | 2.0V ≤ V _{IN} ≤ 5.5V | | 40 | 275 | μV/V | |
| Load Regulation | $\frac{\Delta V_{OUT}}{\Delta I_{OUT}}$ | 0 ≤ I _{OUT} ≤ 1mA | | 90 | 800 | μV/mA | |
| | | -1mA ≤ I _{OUT} ≤ 0 | | 0.4 | 50 | μV/μA | |
| Dropout Voltage (Note 3) | V _{IN} - V _{OUT} | I _{OUT} = 1mA | | 100 | 200 | mV | |
| Short-Circuit Current | I _{SC} | Sourcing to GND | | 7.5 | | mA | |
| | | Sinking from V _{IN} | | 3 | | | |
| Long-Term Stability | $\frac{\Delta V_{OUT}}{\text{Time}}$ | 1000hrs at T _A = +25°C | | 100 | | ppm | |
| Thermal Hysteresis | | (Note 4) | | 130 | | ppm | |
| DYNAMIC CHARACTERISTICS | | | | | | | |
| Noise Voltage | e _{OUT} | 0.1Hz to 10Hz | | 45 | | μV _{p-p} | |
| | | 10Hz to 10kHz | | 160 | | μV _{RMS} | |
| Ripple Rejection | | V _{IN} = 2.0V ±100mV (f = 120Hz) | | 85 | | dB | |
| Turn-On Settling Time | t _R | Settling to 0.1%; C _{OUT} = 5nF | | 200 | | μs | |
| Capacitive-Load Stability Range | C _{OUT} | (Note 2) | 0.1 | | 1000 | nF | |
| INPUT | | | | | | | |
| Supply Voltage Range | V _{IN} | Guaranteed by Line Regulation Test | 2.0 | | 5.5 | V | |
| Quiescent Supply Current | I _{IN} | T _A = +25°C | | 3 | 5 | μA | |
| | | T _A = T _{MIN} to T _{MAX} | | 3 | 6 | | |
| Change in Quiescent Supply Current vs. Input Voltage | $\Delta I_{IN}/\Delta V_{IN}$ | 2V ≤ V _{IN} ≤ 5.5V | | 0.1 | 0.5 | μA/V | |

Electrical Characteristics (MAX6018_21–2.048V)(V_{IN} = 2.25V; C_{OUT} = 47nF, I_{OUT} = 0; T_A = T_{MIN} to T_{MAX}, unless otherwise noted. Typical values are at T_A = +25°C.) (Note 1)

| PARAMETER | SYMBOL | CONDITIONS | MIN | TYP | MAX | UNITS | |
|--|---|---|------------------------|--------|--------|-------------------|---|
| OUTPUT | | | | | | | |
| Output Voltage | V _{OUT} | MAX6018A_21 (0.2%) | T _A = +25°C | 2.0439 | 2.0480 | 2.0521 | V |
| | | MAX6018B_21 (0.4%) | T _A = +25°C | 2.0398 | 2.0480 | 2.0562 | |
| Output Voltage Temperature Drift | TCV _{OUT} | (Note 2) | | 16 | 50 | ppm/°C | |
| Line Regulation | $\frac{\Delta V_{OUT}}{\Delta V_{IN}}$ | 2.25V ≤ V _{IN} ≤ 5.5V | | 45 | 330 | μV/V | |
| Load Regulation | $\frac{\Delta V_{OUT}}{\Delta I_{OUT}}$ | 0 ≤ I _{OUT} ≤ 1mA | | 90 | 1000 | μV/mA | |
| | | -1mA ≤ I _{OUT} ≤ 0 | | 0.3 | 50 | μV/μA | |
| Dropout Voltage (Note 3) | V _{IN} - V _{OUT} | I _{OUT} = 1mA | | 100 | 200 | mV | |
| Short-Circuit Current | I _{SC} | Sourcing to GND | | 10 | | mA | |
| | | Sinking from V _{IN} | | 4 | | | |
| Long-Term Stability | $\frac{\Delta V_{OUT}}{\text{Time}}$ | 1000hrs at T _A = +25°C | | 100 | | ppm | |
| Thermal Hysteresis | | (Note 4) | | 130 | | ppm | |
| DYNAMIC CHARACTERISTICS | | | | | | | |
| Noise Voltage | e _{OUT} | 0.1Hz to 10Hz | | 50 | | μV _{p-p} | |
| | | 10Hz to 10kHz | | 175 | | μV _{RMS} | |
| Ripple Rejection | | V _{IN} = 2.25V ±100mV (f = 120Hz) | | 85 | | dB | |
| Turn-On Settling Time | t _R | Settling to 0.1%; C _{OUT} = 5nF | | 200 | | μs | |
| Capacitive-Load Stability Range | C _{OUT} | (Note 2) | 0.1 | | 1000 | nF | |
| INPUT | | | | | | | |
| Supply Voltage Range | V _{IN} | Guaranteed by Line Regulation Test | 2.25 | | 5.5 | V | |
| Quiescent Supply Current | I _{IN} | T _A = +25°C | | 3 | 5 | μA | |
| | | T _A = T _{MIN} to T _{MAX} | | 3 | 6 | | |
| Change in Quiescent Supply Current vs. Input Voltage | $\Delta I_{IN}/\Delta V_{IN}$ | 2.25V ≤ V _{IN} ≤ 5.5V | | 0.1 | 0.5 | μA/V | |

Note 1: Devices are 100% production tested at T_A = +25°C and are guaranteed by design from T_A = T_{MIN} to T_{MAX}.**Note 2:** Not production tested. Guaranteed by design.**Note 3:** Dropout voltage is the minimum input voltage at which V_{OUT} changes ≤ 0.2% from V_{OUT} at rated V_{IN} and is guaranteed by Load Regulation Test.**Note 4:** Thermal hysteresis is defined as the change in T_A = +25°C output voltage before and after temperature cycling of the device (from T_A = T_{MIN} to T_{MAX}). Initial measurement at T_A = +25°C is followed by temperature cycling the device to T_A = +85°C then to T_A = -40°C and another measurement at T_A = +25°C is compared to the original measurement at T_A = +25°C.

Typical Operating Characteristics

($T_A = +25^\circ\text{C}$, unless otherwise noted.)

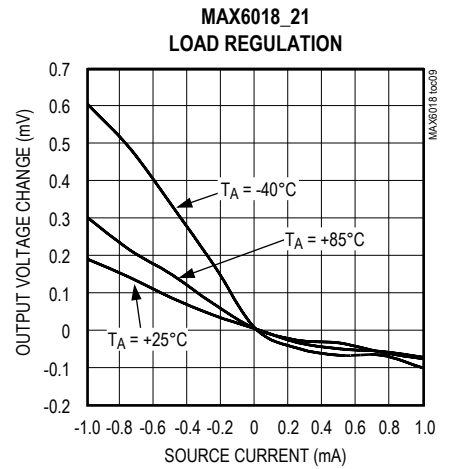
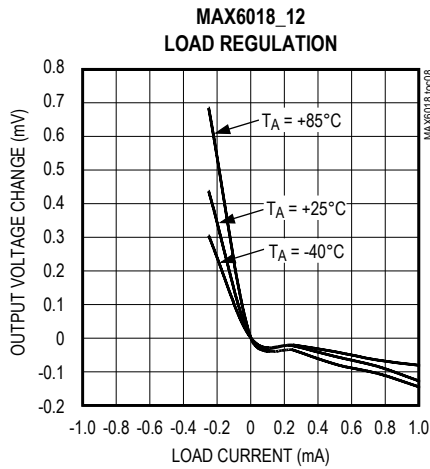
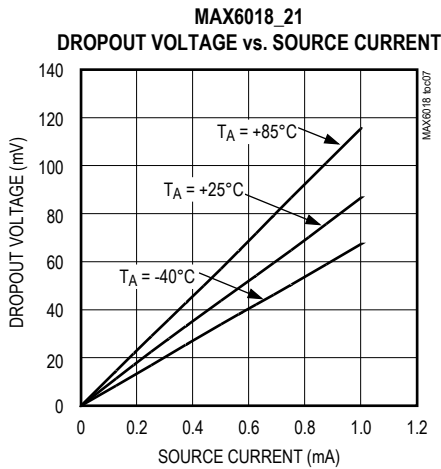
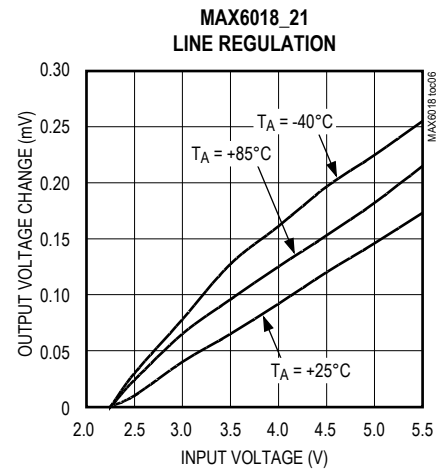
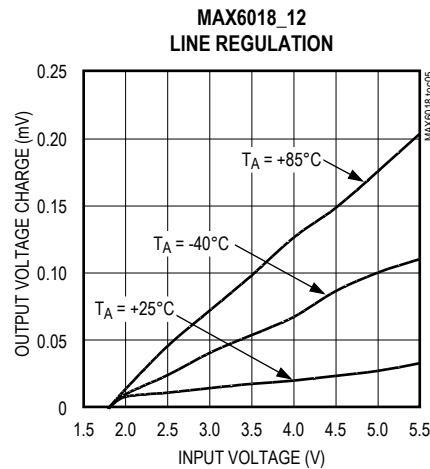
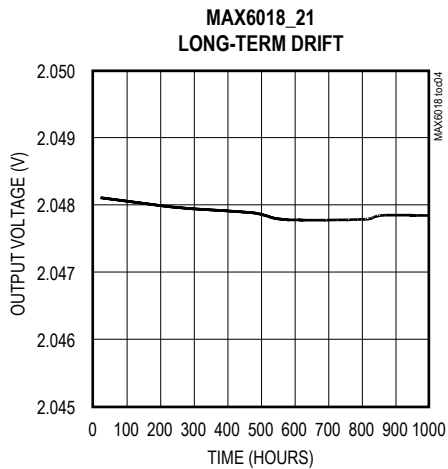
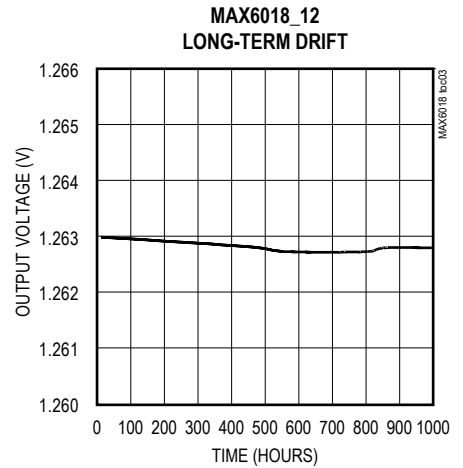
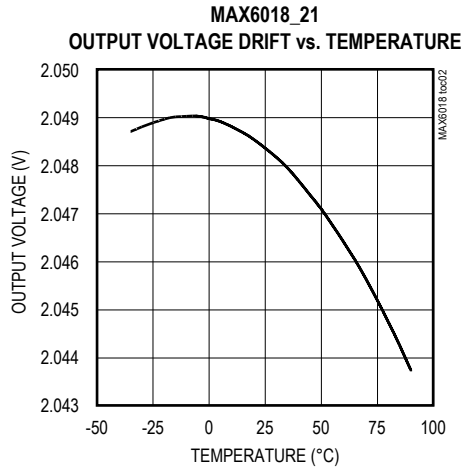
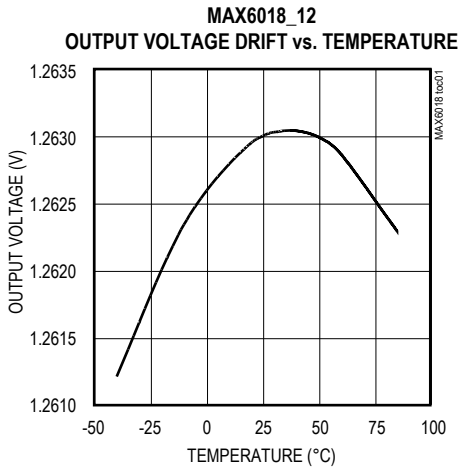

Typical Operating Characteristics (continued)

(TA = +25°C, unless otherwise noted.)

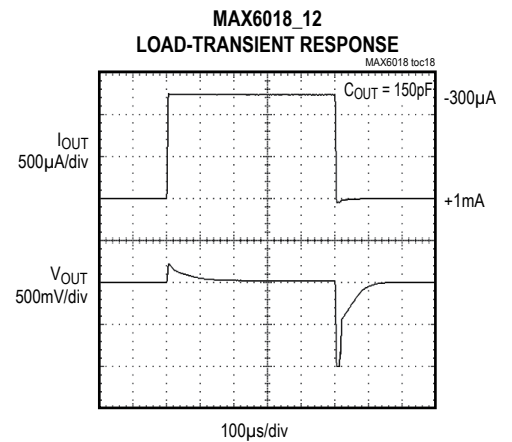
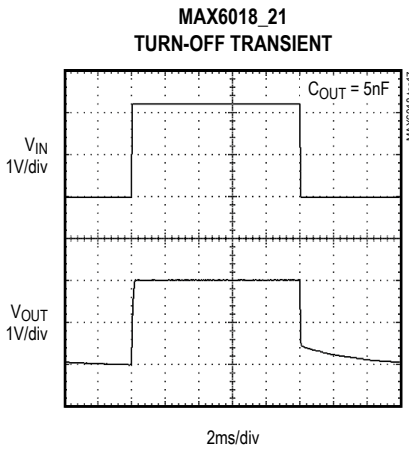
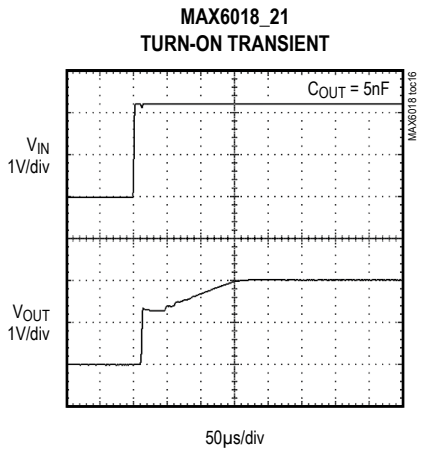
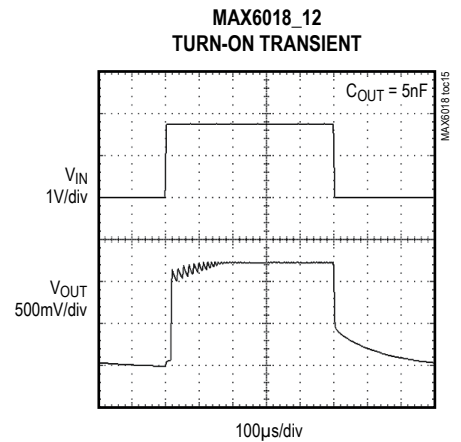
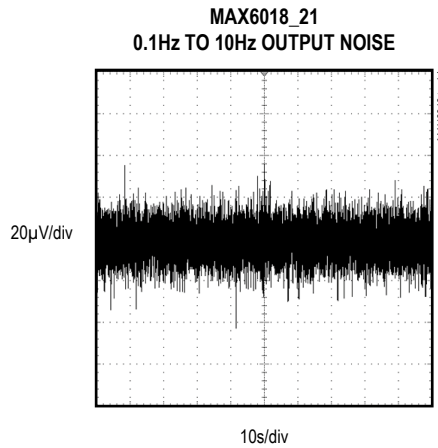
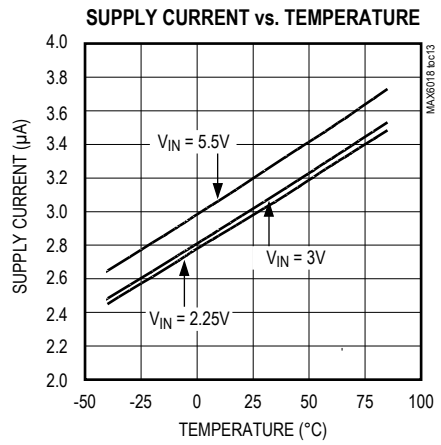
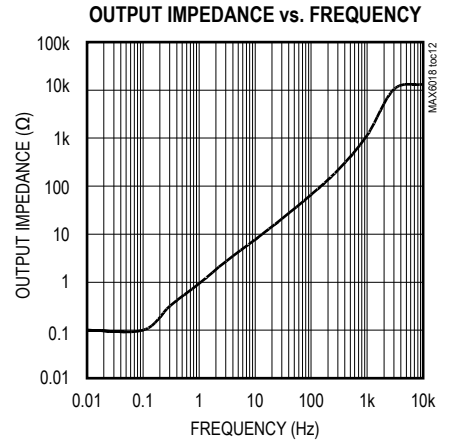
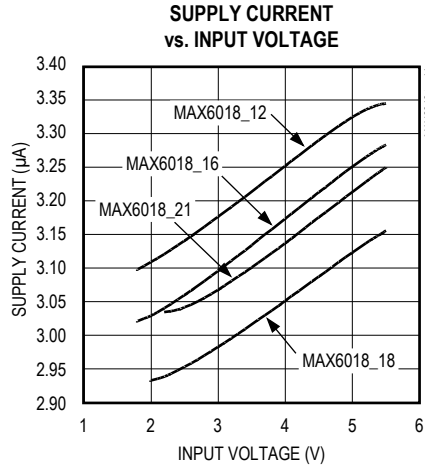
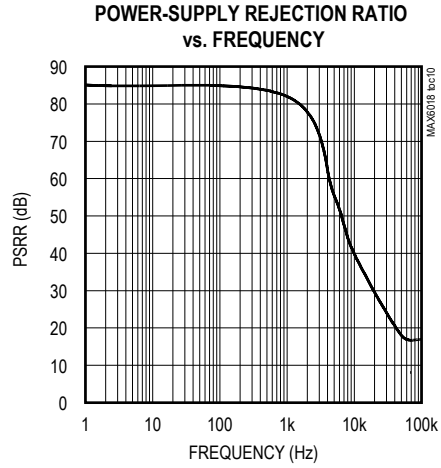

Typical Operating Characteristics (continued)

(TA = +25°C, unless otherwise noted.)

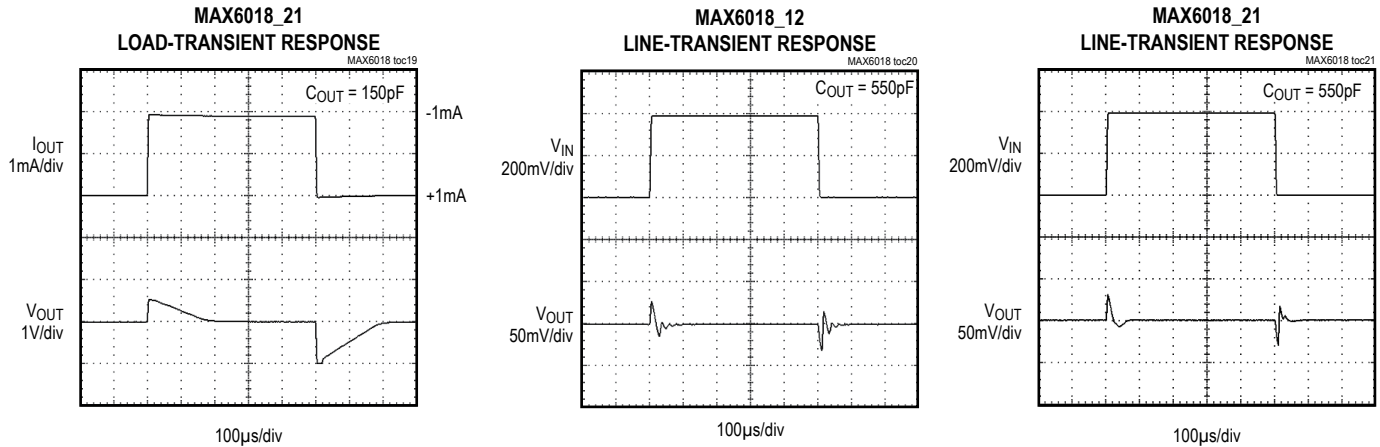

Detailed Description

The MAX6018 is a precision, low-voltage, low-dropout, micropower, bandgap voltage reference in a SOT23 package. This three-terminal reference operates with an input voltage from (VOUT + 200mV) to 5.5V, and is available with output voltage options of 1.2V, 1.6V, 1.8V, and 2.048V. These devices can source up to 1mA with <200mV of dropout voltage, making them attractive for use in low-voltage applications.

Applications Information

Output/Load Capacitance

These devices require a minimum of 100pF load to maintain output stability.

They remain stable for capacitive loads as high as 1μF. In applications where the load or the supply can experience step changes, a larger output capacitor reduces the amount of overshoot (or undershoot) and assists the circuit's transient response. Otherwise, applications may not need more than 100pF.

Supply Current

The 5μA maximum supply current varies only 0.1μA/V with the supply voltage.

When the supply voltage is below the minimum-specified input voltage (as during turn-on), the devices can draw up to 20μA beyond the nominal supply current. The input voltage source must be capable of providing this current to ensure reliable turn-on.

Pin Description

| PIN | NAME | FUNCTION |
|-----|------|---|
| 1 | IN | Supply Voltage Input. Bypass with a 0.1μF capacitor to ground. |
| 2 | OUT | Reference Voltage Output. Bypass with at least 100pF to ground. (See <i>Output/Load Capacitance</i> section). |
| 3 | GND | Ground |

Turn-On Time

These devices typically turn on and settle to within 0.1% of their final value in 200μs. The turn-on time can increase up to 1ms with the device operating at the minimum dropout voltage and the maximum load.

MAX6018

Precision, Micropower, 1.8V Supply,
Low-Dropout, SOT23 Voltage Reference

Package Information

For the latest package outline information and land patterns (footprints), go to www.maximintegrated.com/packages. Note that a "+", "#", or "-" in the package code indicates RoHS status only. Package drawings may show a different suffix character, but the drawing pertains to the package regardless of RoHS status.

| PACKAGE TYPE | PACKAGE CODE | OUTLINE NO. | LAND PATTERN NO. |
|--------------|--------------|-------------------------|-------------------------|
| 3 SOT23 | U3+1 | 21-0051 | 90-0179 |

Chip Information

TRANSISTOR COUNT: 87

PROCESS: BiCMOS

MAX6018

Precision, Micropower, 1.8V Supply,
Low-Dropout, SOT23 Voltage Reference

Revision History

| REVISION NUMBER | REVISION DATE | DESCRIPTION | PAGES CHANGED |
|-----------------|---------------|-------------------------|---------------|
| 3 | 10/15 | Added lead-free options | 1 |

For pricing, delivery, and ordering information, please contact Maxim Direct at 1-888-629-4642, or visit Maxim Integrated's website at www.maximintegrated.com.

Maxim Integrated cannot assume responsibility for use of any circuitry other than circuitry entirely embodied in a Maxim Integrated product. No circuit patent licenses are implied. Maxim Integrated reserves the right to change the circuitry and specifications without notice at any time. The parametric values (min and max limits) shown in the Electrical Characteristics table are guaranteed. Other parametric values quoted in this data sheet are provided for guidance.

Mouser Electronics

Authorized Distributor

Click to View Pricing, Inventory, Delivery & Lifecycle Information:

[Analog Devices Inc.:](#)

[MAX6018AEUR12+T](#) [MAX6018BEUR18+T](#) [MAX6018BEUR21+T](#) [MAX6018AEUR16+T](#) [MAX6018AEUR18+T](#)
[MAX6018AEUR21+T](#) [MAX6018BEUR12+T](#) [MAX6018BEUR16+T](#) [MAX6018BEUR18+](#)