

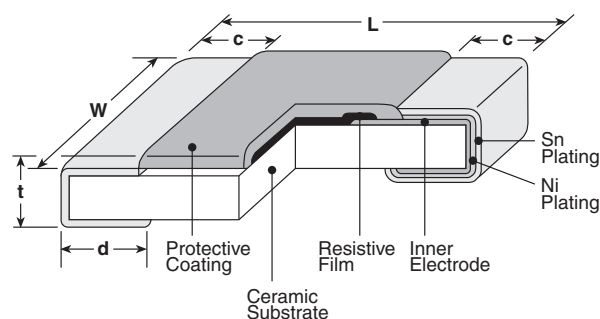

### features

- Superior to RK73 series in maximum working voltage
- Suitable for flow and reflow solderings
- Products meet EU RoHS requirements. EU RoHS regulation is not intended for Pb-glass contained in electrode, resistor element and glass.
- Suitable for high reliable applications like automotives
- AEC-Q200 qualified

### dimensions and construction



Type (Inch Size Code)	Dimensions inches (mm)				
	L	W	c	d	t
<b>1J</b> (0603)	.063±.008 (1.6±0.2)	.031±.004 (0.8±0.1)	.012±.004 (0.3±0.1)	.012±.004 (0.3±0.1)	.018±.004 (0.45±0.1)
<b>2A</b> (0805)	.079±.008 (2.0±0.2)	.049±.004 (1.25±0.1)	.016±.008 (0.4±0.2)	.012 <sup>+0.008</sup> <sub>-.004</sub> (0.3 <sup>+0.2</sup> <sub>-.1</sub> )	.02±.004 (0.5±0.1)
<b>2B</b> (1206)	.126±.008 (3.2±0.2)	.063±.008 (1.6±0.2)	.02±.012 (0.5±0.3)	.016 <sup>+0.008</sup> <sub>-.004</sub> (0.4 <sup>+0.2</sup> <sub>-.1</sub> )	.024±.004 (0.6±0.1)

### Derating Curve

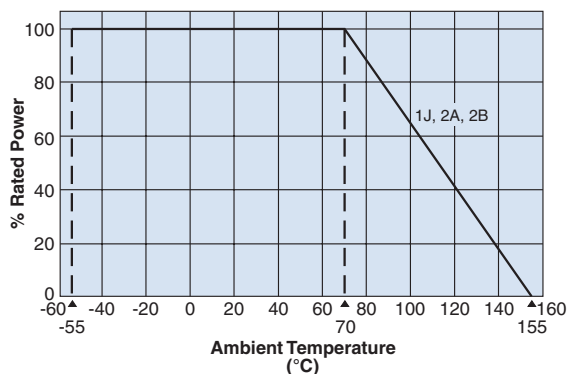

For resistors operated at an ambient temperature of 70°C or above, a power rating shall be derated in accordance with the above derating curve.

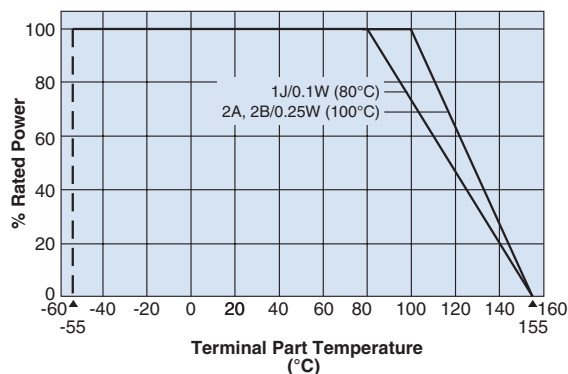

For resistors operated at a terminal part temperature of described for each size or above, a power rating shall be derated in accordance with the above derating curve.

Please refer to "Introduction of the derating curve based on the terminal part temperature" in the beginning of our catalog before use.

### ordering information

<b>HV73V</b>	<b>2A</b>	<b>T</b>	<b>TD</b>	<b>104</b>	<b>J</b>
Type	Size	Termination Material	Packaging	Nominal Resistance	Resistance Tolerance
HV73V	1J: 0.1W 2A: 0.25W 2B: 0.25W	T: Sn	TD: 7" 4mm pitch punched paper TE: 7" 4mm pitch embossed plastic For further information on packaging, please refer to Appendix A	±0.5%, ±1%: 3 significant figures + 1 multiplier ±2%, ±5%: 2 significant figures +1 multiplier	D: ±0.5% F: ±1% G: ±2% J: ±5%

### applications and ratings

Part Designation	Power Rating @ 70°C	Rated Ambient Temp.	Rated Terminal Part Temp.	T.C.R. (ppm/°C) Max.	Resistance Range (Ω)				Maximum Working Voltage	Maximum Overload Voltage (D.C.)*	Operating Temperature Range
					E-24/E-96 (D±0.5%)	E-24/E-96 (F±1%)	E-24 (G±2%)	E-24 (J±5%)			
HV73V1J	0.1W	70°C	80°C	±100**	—	10k - 10M	10k - 10M	10k - 10M	350V	500V*	-55°C to +155°C
HV73V2A	0.25W	70°C	100°C	±100	100k - 1M	100k - 10M	100k - 10M	100k - 10M	400V	800V*	
				±200	—	—	—	11M - 51M			
HV73V2B	0.25W	70°C	100°C	±100	100k - 1M	100k - 10M	100k - 10M	100k - 10M	800V	1000V*	
				±200	—	—	—	11M - 51M			

Rated voltage =  $\sqrt{\text{Power rating} \times \text{resistance value}}$  or max. working voltage, whichever is lower

\* Maximum Overload Voltage is specified by D.C. voltage    \*\* Cold T.C.R. (-55°C ~ +25°C) of 1.02MΩ ~ 10MΩ is +200x10<sup>-6</sup>/K

If any questions should arise whether to use the "Rated Ambient Temperature" or the "Rated Terminal Part Temperature," please give priority to the "Rated Terminal Part Temperature." Prior to use and for more details refer to "Introduction of the derating curves on the terminal part temperature" in the beginning of the catalog.

### environmental applications

#### Temperature Rise

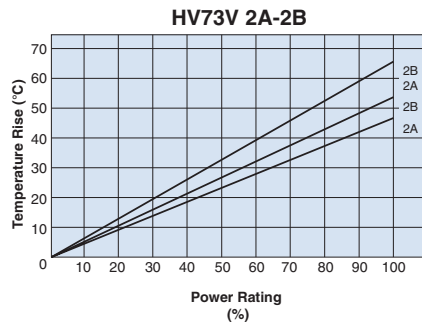
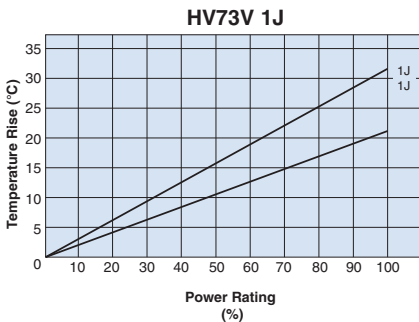

Regarding the temperature rise, the value of the temperature varies per conditions and board for use since the temperature is measured under our measuring conditions.

Measurement condition  
Room temperature: 25°C  
PCB: FR-4t = 1.6mm  
Cu foil thickness: 35μm

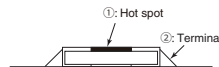

#### One-Pulse Limiting Electric Power

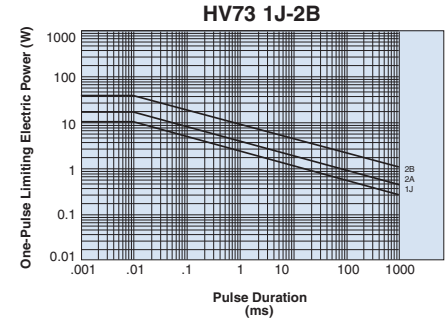

The maximum applicable voltage is equal to the max. overload voltage. Please contact factory for resistance characteristics of continuous applied pulse.

### Performance Characteristics

Parameter	Requirement Δ R ±(%+0.1Ω)		Test Method
	Limit	Typical	
Resistance	Within regulated tolerance	—	25°C
T.C.R.	Within specified T.C.R.	—	+25°C/-55°C and +25°C/+125°C
Overload (Short time)	±2%	±0.5%	Rated Voltage (D.C.) x 2.5 for 5 seconds
Resistance to Solder Heat	±1%	±0.5%	260°C ± 5°C, 10 seconds ± 1 second
Rapid Change of Temperature	±0.5%: (10kΩ≤R≤10MΩ) ±1%: (11MΩ≤R≤51MΩ)	±0.3%: (10kΩ≤R≤10MΩ) ±0.5%: (11MΩ≤R≤51MΩ)	-55°C (30 minutes), +125°C (30 minutes), 100 cycles
Moisture Resistance	±2%	±0.75%	40°C ± 2°C, 90%-95% RH, 1000 hours, 1.5 hr ON, 0.5 hr OFF cycle
Endurance at 70°C	±2%	±0.75%	70°C ± 2°C, 1000 hours, 1.5 hr ON, 0.5 hr OFF cycle
High Temperature Exposure	±2%	±0.3%	+155°C, 1000 hours

Additional environmental applications can also be found at [www.koaspeer.com](http://www.koaspeer.com)

Specifications given herein may be changed at any time without prior notice. Please confirm technical specifications before you order and/or use.

11/05/19