

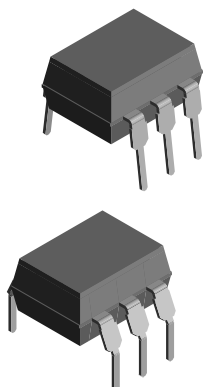

Optocoupler, Phototransistor Output, with Base Connection

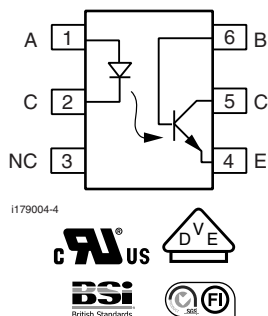

17201_4



FEATURES

- Isolation test voltage 5000 V_{RMS}
- Long term stability
- Industry standard dual-in-line package
- V_{IORM} = 850 V
- Material categorization:
For definitions of compliance please see www.vishay.com/doc?99912



RoHS
COMPLIANT

AGENCY APPROVALS

- UL file no. E52744
- cUL tested to CSA 22.2 bulletin 5A
- DIN EN 60747-5-5 (0884-5) available with option 1
- BSI IEC 60950-1:2006 IEC 60065
- FIMKO
- CQC

DESCRIPTION

The CNY17 is an optically coupled pair consisting of a gallium arsenide infrared emitting diode optically coupled to a silicon NPN phototransistor.

Signal information, including a DC level, can be transmitted by the device while maintaining a high degree of electrical isolation between input and output.

The CNY17 can be used to replace relays and transformers in many digital interface applications, as well as analog applications such as CRT modulation.

| ORDERING INFORMATION | | | | | | | | |
|---------------------------|---|----------|-----------|------------|------------|---|--|--|
| C | N | Y | 1 | 7 | - | # | | |
| PART NUMBER | | | | | | | | |
| AGENCY CERTIFIED/PACKAGE | | CTR (%) | | | | | | |
| cUL, VDE, BSI, FIMKO, CQC | | 40 to 80 | 63 to 125 | 100 to 200 | 160 to 320 | | | |
| DIP-6 | | CNY17-1. | CNY17-2. | CNY17-3. | CNY17-4. | | | |
| DIP-6, 400 mil | | CNY17G-1 | CNY17G-2 | CNY17G-3 | CNY17G-4 | | | |

| ABSOLUTE MAXIMUM RATINGS (T _{amb} = 25 °C, unless otherwise specified) | | | | |
|---|----------------|-------------------|-------|------|
| PARAMETER | TEST CONDITION | SYMBOL | VALUE | UNIT |
| INPUT | | | | |
| Reverse voltage | | V _R | 5 | V |
| Forward current | | I _F | 60 | mA |
| Surge current | t ≤ 10 μs | I _{FSM} | 3 | A |
| Power dissipation | | P _{diss} | 100 | mW |
| OUTPUT | | | | |
| Collector emitter breakdown voltage | | BV _{CEO} | 70 | V |
| Emitter base breakdown voltage | | BV _{EBO} | 7 | V |
| Collector current | | I _C | 50 | mA |
| | t < 1 ms | I _C | 100 | mA |
| Power dissipation | | P _{diss} | 150 | mW |



| ABSOLUTE MAXIMUM RATINGS ($T_{amb} = 25\text{ }^{\circ}\text{C}$, unless otherwise specified) | | | | |
|--|--|------------|----------------|--------------------|
| PARAMETER | TEST CONDITION | SYMBOL | VALUE | UNIT |
| COUPLER | | | | |
| Isolation test voltage between emitter and detector referred to climate DIN 50014, part 2, Nov. 74 | $t = 1\text{ min}$ | V_{ISO} | 5000 | V_{RMS} |
| Creepage distance (CNY17.) | | | ≥ 7 | mm |
| Clearance distance (CNY17.) | | | ≥ 7 | mm |
| Creepage distance (CNY17G) | | | ≥ 8 | mm |
| Clearance distance (CNY17G) | | | ≥ 8 | mm |
| Isolation thickness between emitter and detector | | | ≥ 0.4 | mm |
| Comparative tracking index per DIN IEC 112/VDE 0303, part 1 | | | 250 | |
| Isolation resistance | $V_{IO} = 500\text{ V}, T_{amb} = 25\text{ }^{\circ}\text{C}$ | R_{IO} | $\geq 10^{12}$ | Ω |
| | $V_{IO} = 500\text{ V}, T_{amb} = 100\text{ }^{\circ}\text{C}$ | R_{IO} | $\geq 10^{11}$ | Ω |
| Storage temperature | | T_{stg} | - 55 to + 125 | $^{\circ}\text{C}$ |
| Operating temperature | | T_{amb} | - 55 to + 100 | $^{\circ}\text{C}$ |
| Soldering temperature ⁽¹⁾ | max. 10 s, dip soldering: distance to seating plane $\geq 1.5\text{ mm}$ | T_{slid} | 260 | $^{\circ}\text{C}$ |

Notes

- Stresses in excess of the absolute maximum ratings can cause permanent damage to the device. Functional operation of the device is not implied at these or any other conditions in excess of those given in the operational sections of this document. Exposure to absolute maximum ratings for extended periods of the time can adversely affect reliability.

⁽¹⁾ Refer to wave profile for soldering conditions for through hole devices.

| ELECTRICAL CHARACTERISTICS ($T_{amb} = 25\text{ }^{\circ}\text{C}$, unless otherwise specified) | | | | | | | |
|--|---|---------|-------------|------|------|------|---------------|
| PARAMETER | TEST CONDITION | PART | SYMBOL | MIN. | TYP. | MAX. | UNIT |
| INPUT | | | | | | | |
| Forward voltage | $I_F = 60\text{ mA}$ | | V_F | | 1.25 | 1.65 | V |
| Breakdown voltage | $I_R = 10\text{ }\mu\text{A}$ | | V_{BR} | 6 | | | V |
| Reverse current | $V_R = 6\text{ V}$ | | I_R | | 0.01 | 10 | μA |
| Capacitance | $V_R = 0\text{ V}, f = 1\text{ MHz}$ | | C_O | | 25 | | pF |
| Thermal resistance | | | R_{th} | | 750 | | K/W |
| OUTPUT | | | | | | | |
| Collector emitter capacitance | $V_{CE} = 5\text{ V}, f = 1\text{ MHz}$ | | C_{CE} | | 5.2 | | pF |
| Collector base capacitance | $V_{CB} = 5\text{ V}, f = 1\text{ MHz}$ | | C_{CB} | | 6.5 | | pF |
| Emitter base capacitance | $V_{EB} = 5\text{ V}, f = 1\text{ MHz}$ | | C_{EB} | | 7.5 | | pF |
| Thermal resistance | | | R_{th} | | 500 | | K/W |
| COUPLER | | | | | | | |
| Collector emitter, saturation voltage | $I_F = 10\text{ mA}, I_C = 2.5\text{ mA}$ | | V_{CEsat} | | 0.25 | 0.4 | V |
| Coupling capacitance | | | C_C | | 0.6 | | pF |
| Collector emitter, leakage current | $V_{CE} = 10\text{ V}$ | CNY17-1 | I_{CEO} | | 2 | 50 | nA |
| | | CNY17-2 | I_{CEO} | | 2 | 50 | nA |
| | | CNY17-3 | I_{CEO} | | 5 | 100 | nA |
| | | CNY17-4 | I_{CEO} | | 5 | 100 | nA |

Note

- Minimum and maximum values were tested requirements. Typical values are characteristics of the device and are the result of engineering evaluations. Typical values are for information only and are not part of the testing requirements.



| CURRENT TRANSFER RATIO | | | | | | | |
|------------------------|---|---------|--------|------|------|------|------|
| PARAMETER | TEST CONDITION | PART | SYMBOL | MIN. | TYP. | MAX. | UNIT |
| I_C/I_F | $V_{CE} = 5\text{ V}, I_F = 10\text{ mA}$ | CNY17-1 | CTR | 40 | | 80 | % |
| | | CNY17-2 | CTR | 63 | | 125 | % |
| | | CNY17-3 | CTR | 100 | | 200 | % |
| | | CNY17-4 | CTR | 160 | | 320 | % |
| | $V_{CE} = 5\text{ V}, I_F = 1\text{ mA}$ | CNY17-1 | CTR | 13 | 30 | | % |
| | | CNY17-2 | CTR | 22 | 45 | | % |
| | | CNY17-3 | CTR | 34 | 70 | | % |
| | | CNY17-4 | CTR | 56 | 90 | | % |

Note

- Current transfer ratio and collector-emitter leakage current by dash number (T_{amb} °C).

| SWITCHING CHARACTERISTICS ($T_{amb} = 25\text{ °C}$, unless otherwise specified) | | | | | | | |
|--|---|---------|-----------|------|------|------|---------------|
| PARAMETER | TEST CONDITION | PART | SYMBOL | MIN. | TYP. | MAX. | UNIT |
| LINEAR OPERATION (WITHOUT SATURATION) | | | | | | | |
| Turn-on time | $I_F = 10\text{ mA}, V_{CC} = 5\text{ V}, R_L = 75\ \Omega$ | | t_{on} | | 3 | | μs |
| Rise time | $I_F = 10\text{ mA}, V_{CC} = 5\text{ V}, R_L = 75\ \Omega$ | | t_r | | 2 | | μs |
| Turn-off time | $I_F = 10\text{ mA}, V_{CC} = 5\text{ V}, R_L = 75\ \Omega$ | | t_{off} | | 2.3 | | μs |
| Fall time | $I_F = 10\text{ mA}, V_{CC} = 5\text{ V}, R_L = 75\ \Omega$ | | t_f | | 2 | | μs |
| Cut-off frequency | $I_F = 10\text{ mA}, V_{CC} = 5\text{ V}, R_L = 75\ \Omega$ | | f_{CO} | | 250 | | kHz |
| SWITCHING OPERATION (WITH SATURATION) | | | | | | | |
| Turn-on time | $I_F = 20\text{ mA}$ | CNY17-1 | t_{on} | | 3 | | μs |
| | $I_F = 10\text{ mA}$ | CNY17-2 | t_{on} | | 4.2 | | μs |
| | | CNY17-3 | t_{on} | | 4.2 | | μs |
| | $I_F = 5\text{ mA}$ | CNY17-4 | t_{on} | | 6 | | μs |
| Rise time | $I_F = 20\text{ mA}$ | CNY17-1 | t_r | | 2 | | μs |
| | $I_F = 10\text{ mA}$ | CNY17-2 | t_r | | 3 | | μs |
| | | CNY17-3 | t_r | | 3 | | μs |
| | $I_F = 5\text{ mA}$ | CNY17-4 | t_r | | 4.6 | | μs |
| Turn-off time | $I_F = 20\text{ mA}$ | CNY17-1 | t_{off} | | 18 | | μs |
| | $I_F = 10\text{ mA}$ | CNY17-2 | t_{off} | | 23 | | μs |
| | | CNY17-3 | t_{off} | | 23 | | μs |
| | $I_F = 5\text{ mA}$ | CNY17-4 | t_{off} | | 25 | | μs |
| Fall time | $I_F = 20\text{ mA}$ | CNY17-1 | t_f | | 11 | | μs |
| | $I_F = 10\text{ mA}$ | CNY17-2 | t_f | | 14 | | μs |
| | | CNY17-3 | t_f | | 14 | | μs |
| | $I_F = 5\text{ mA}$ | CNY17-4 | t_f | | 15 | | μs |



TYPICAL CHARACTERISTICS ($T_{amb} = 25\text{ }^{\circ}\text{C}$, unless otherwise specified)

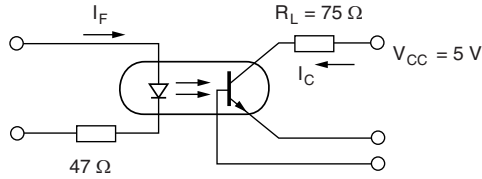

icny17_01

Fig. 1 - Linear Operation (without Saturation)

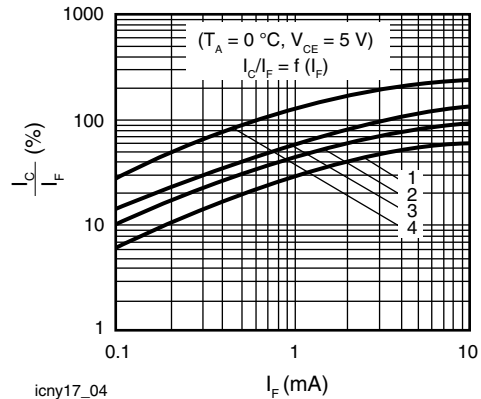

icny17_04

Fig. 3 - Current Transfer Ratio vs. Diode Current

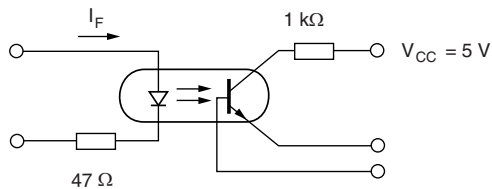

icny17_02

Fig. 1 - Switching Operation (with Saturation)

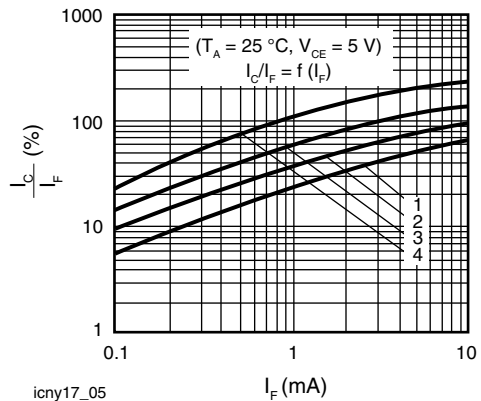

icny17_05

Fig. 4 - Current Transfer Ratio vs. Diode Current

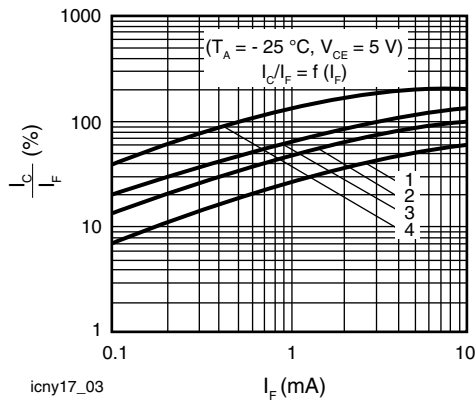

icny17_03

Fig. 2 - Current Transfer Ratio vs. Diode Current

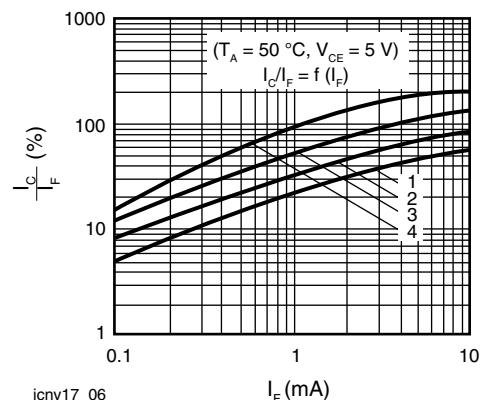

icny17_06

Fig. 5 - Current Transfer Ratio vs. Diode Current

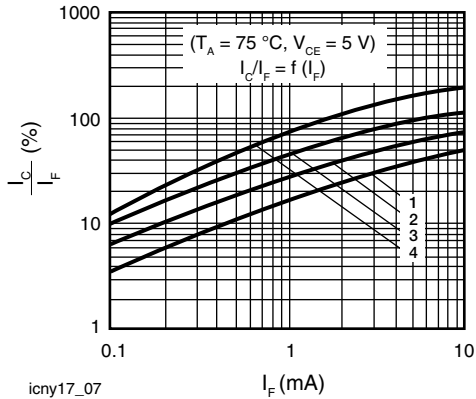

Fig. 6 - Current Transfer Ratio vs. Diode Current

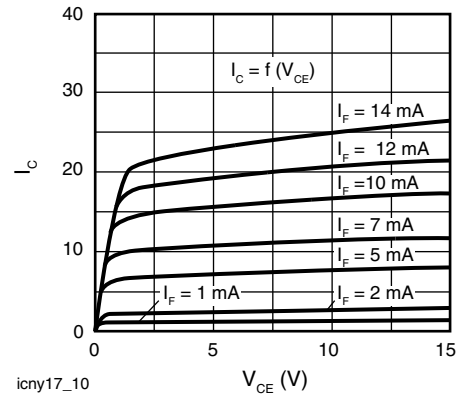

Fig. 9 - Output Characteristics

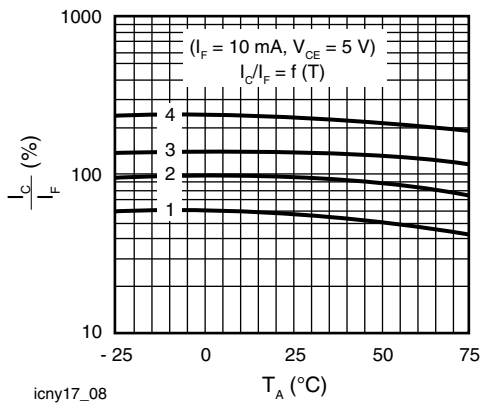

Fig. 7 - Current Transfer Ratio (CTR) vs. Temperature

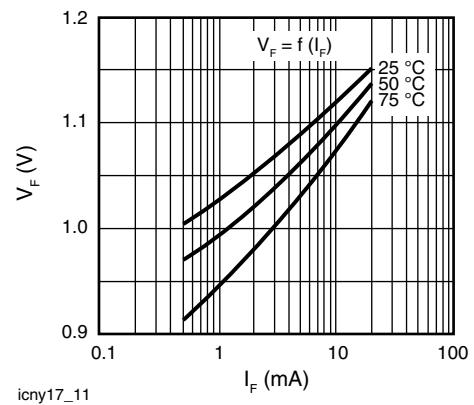

Fig. 10 - Forward Voltage vs. Forward Current

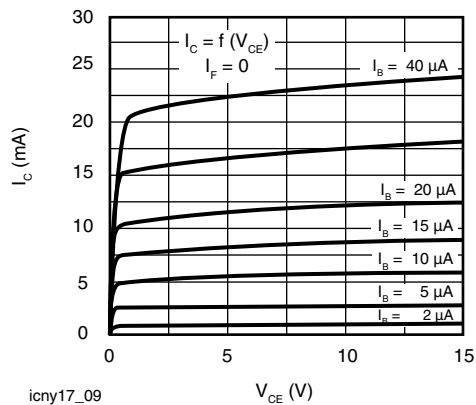

Fig. 8 - Transistor Characteristics

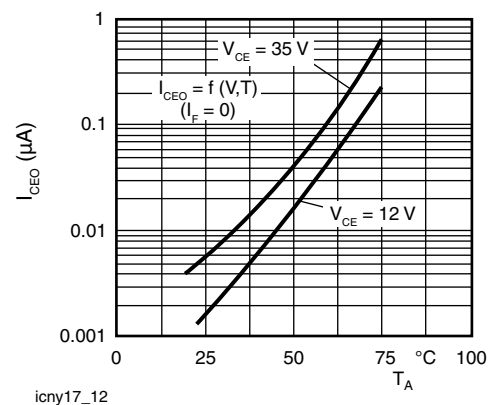

Fig. 11 - Leakage Current vs. Ambient Temperature

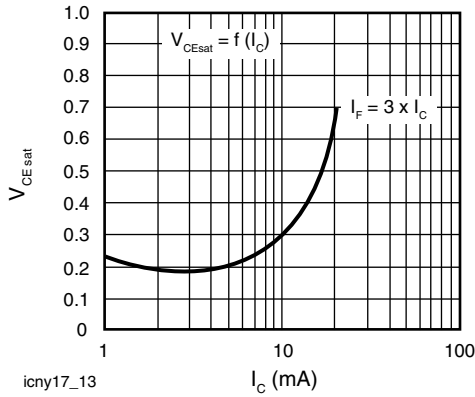

Fig. 12 - Saturation Voltage vs. Collector Current and Modulation Depth CNY17-1

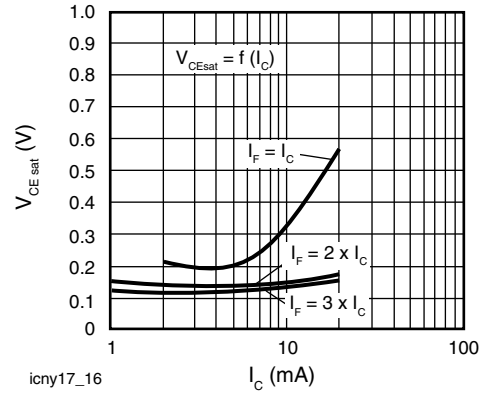

Fig. 15 - Saturation Voltage vs. Collector Current and Modulation Depth CNY17-4

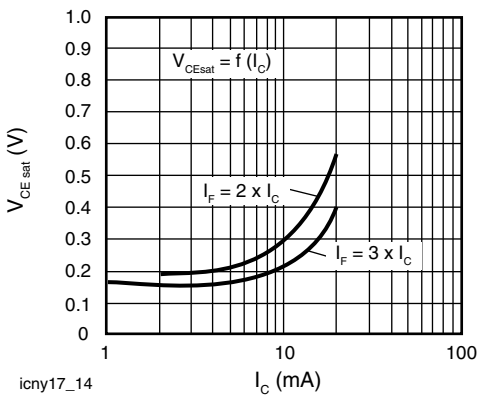

Fig. 13 - Saturation Voltage vs. Collector Current and Modulation Depth CNY17-2

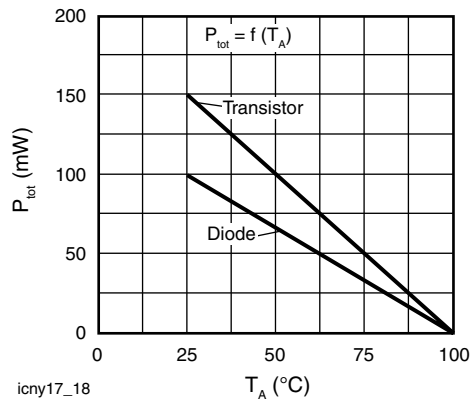

Fig. 16 - Permissible Power Dissipation for Transistor and Diode

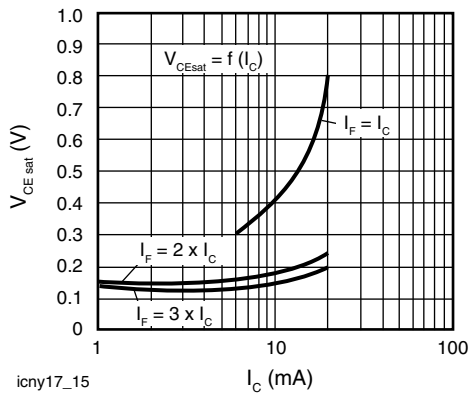
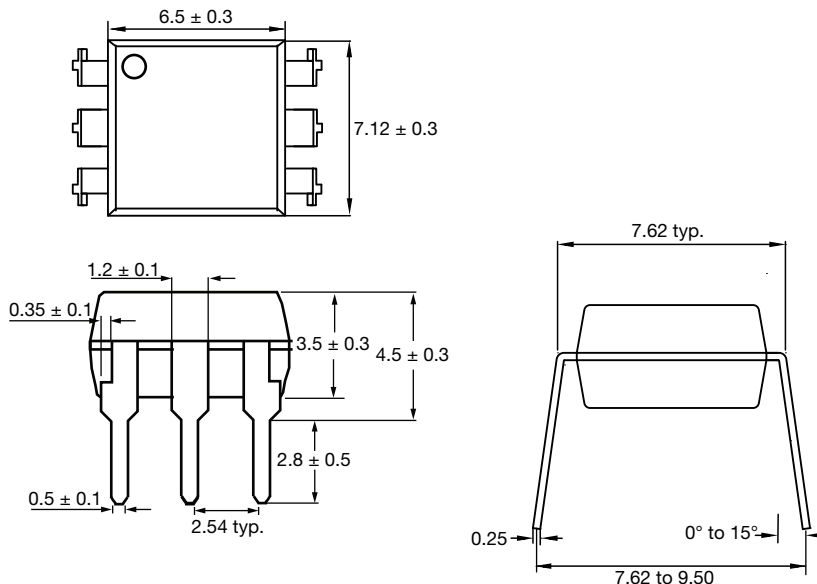

Fig. 14 - Saturation Voltage vs. Collector Current and Modulation Depth CNY17-3



PACKAGE DIMENSIONS in millimeters

DIP-6



DIP-6, 400 mil

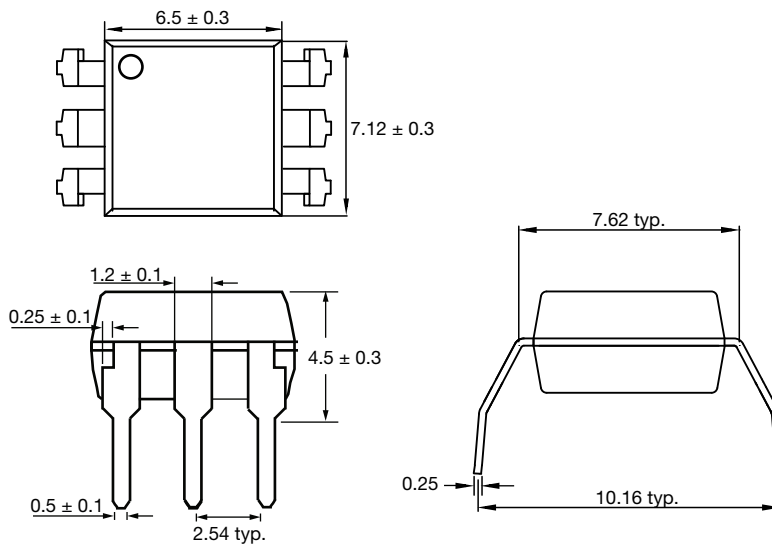

PACKAGE MARKING

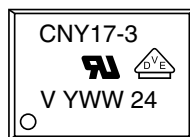



Disclaimer

ALL PRODUCT, PRODUCT SPECIFICATIONS AND DATA ARE SUBJECT TO CHANGE WITHOUT NOTICE TO IMPROVE RELIABILITY, FUNCTION OR DESIGN OR OTHERWISE.

Vishay Intertechnology, Inc., its affiliates, agents, and employees, and all persons acting on its or their behalf (collectively, "Vishay"), disclaim any and all liability for any errors, inaccuracies or incompleteness contained in any datasheet or in any other disclosure relating to any product.

Vishay makes no warranty, representation or guarantee regarding the suitability of the products for any particular purpose or the continuing production of any product. To the maximum extent permitted by applicable law, Vishay disclaims (i) any and all liability arising out of the application or use of any product, (ii) any and all liability, including without limitation special, consequential or incidental damages, and (iii) any and all implied warranties, including warranties of fitness for particular purpose, non-infringement and merchantability.

Statements regarding the suitability of products for certain types of applications are based on Vishay's knowledge of typical requirements that are often placed on Vishay products in generic applications. Such statements are not binding statements about the suitability of products for a particular application. It is the customer's responsibility to validate that a particular product with the properties described in the product specification is suitable for use in a particular application. Parameters provided in datasheets and / or specifications may vary in different applications and performance may vary over time. All operating parameters, including typical parameters, must be validated for each customer application by the customer's technical experts. Product specifications do not expand or otherwise modify Vishay's terms and conditions of purchase, including but not limited to the warranty expressed therein.

Except as expressly indicated in writing, Vishay products are not designed for use in medical, life-saving, or life-sustaining applications or for any other application in which the failure of the Vishay product could result in personal injury or death. Customers using or selling Vishay products not expressly indicated for use in such applications do so at their own risk. Please contact authorized Vishay personnel to obtain written terms and conditions regarding products designed for such applications.

No license, express or implied, by estoppel or otherwise, to any intellectual property rights is granted by this document or by any conduct of Vishay. Product names and markings noted herein may be trademarks of their respective owners.