

REVISIONS					
P	LTR	DESCRIPTION	DATE	DRN	APVD
R		REVISED PER ECO-17-002583	08APR2017	RS	MM
S		REVISED PER ECO-20-001323	17JUN2020	SM	JO

- 1 HOUSING: FLAME RETARDANT, LCP, BLACK
POST: BRASS
- 2 POINT OF MEASUREMENT FOR PLATING THICKNESS
- 3 THE NOTED DIMENSIONS APPLY FROM THE BASIC DIMENSION LINE (NOT THE POST CENTERLINE) TO THE SURFACE INDICATED
- 4 ON ASSEMBLIES WITH FOUR OR MORE POSITIONS, TWO POLARIZATION SLOTS.
ON ASSEMBLIES WITH TWO OR THREE POSITIONS, ONE POLARIZATION SLOT.
- 5 FOR USE WITH .062±.008 PRINTED CIRCUIT BOARD
- 6 .000030 GOLD IN THE CONTACT AREA,
.000100-.000200 MATTE TIN-LEAD ON THE SOLDER TAIL, ALL OVER .000050 NICKEL
- 7 .000030 GOLD IN THE CONTACT AREA,
.000100-.000200 MATTE TIN ON THE SOLDER TAIL, ALL OVER .000050 NICKEL
- 8 HIGH TEMPERATURE CONFIGURATION.
- 9 OBSOLETE PARTS: OBSOLETE CIS STREAMLINING PER D.RENAUD/D.SINISI
- 10 .010 RECESS PERMISSIBLE IN THIS AREA FOR MOLD SHUT OFF

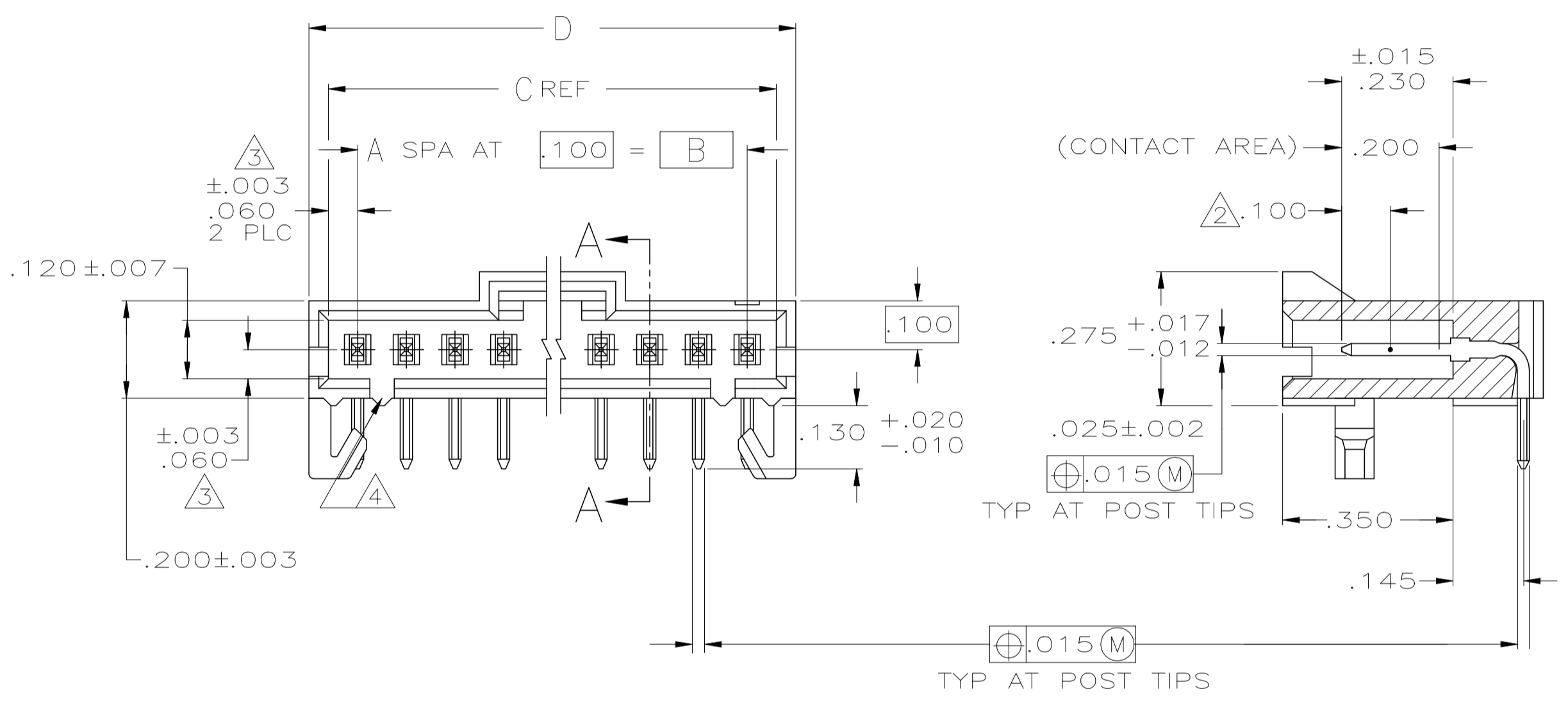

SECTION A-A

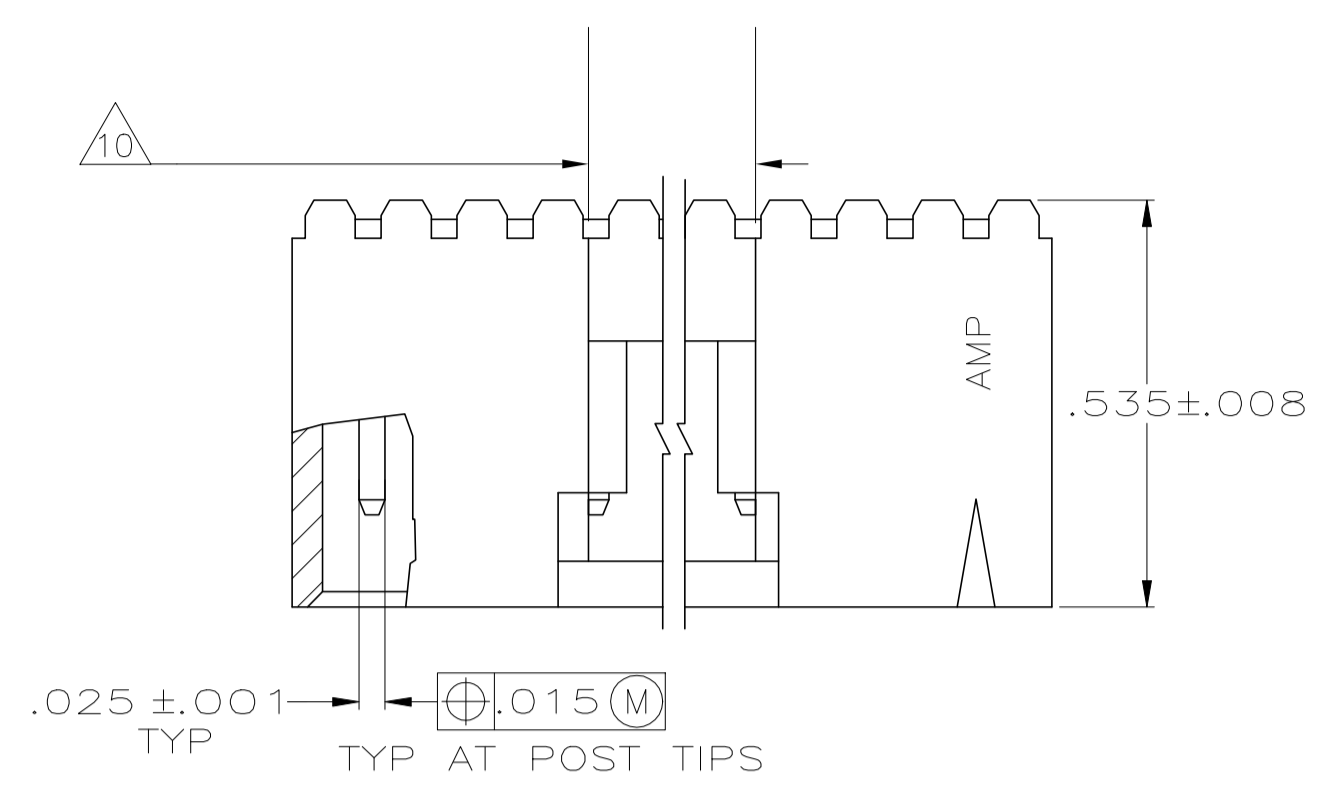
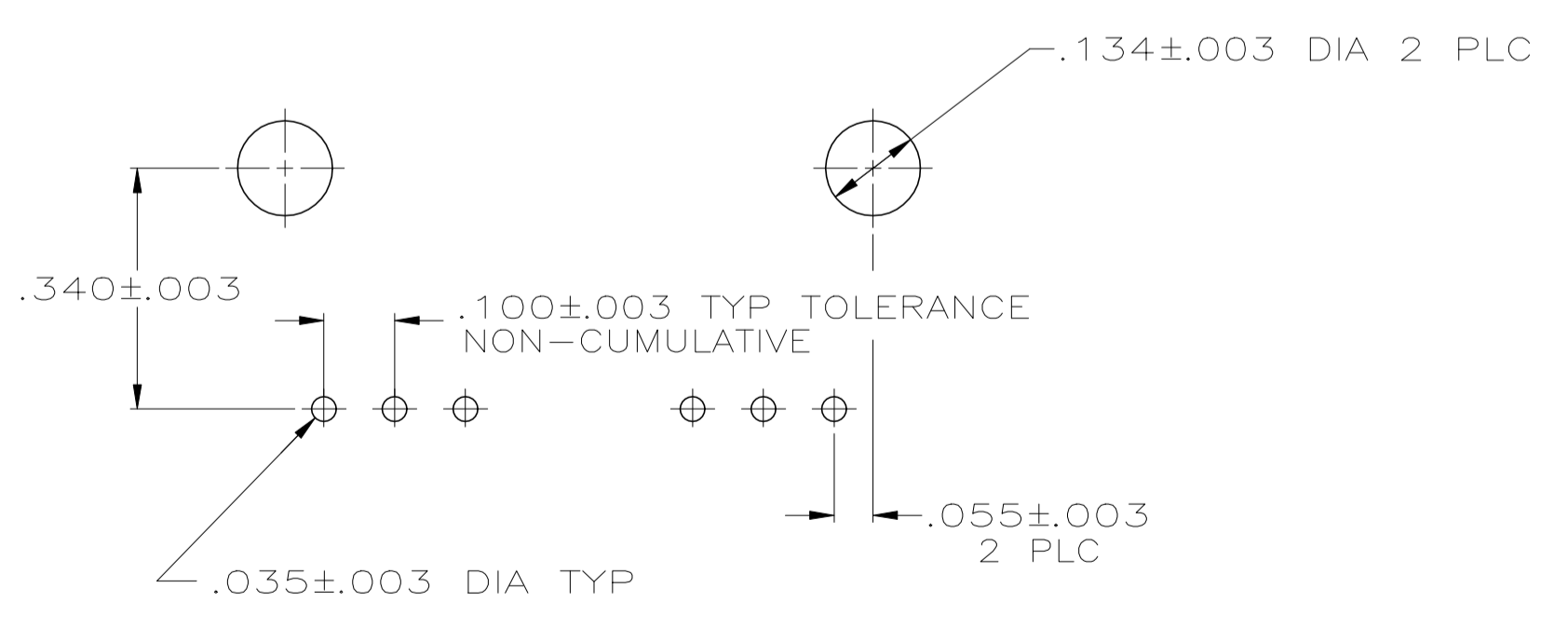

RECOMMENDED HOLE LAYOUT

REMARKS	PLATING	D	C	B	A	NO OF POS	ASSEMBLY PART NUMBER
OBSOLETE		2.595	2.520	2.400	24	25	7-103904-4
		2.495	2.420	2.300	23	24	7-103904-3
		2.395	2.320	2.200	22	23	7-103904-2
		2.295	2.220	2.100	21	22	7-103904-1
		2.195	2.120	2.000	20	21	7-103904-0
		2.095	2.020	1.900	19	20	6-103904-9
		1.995	1.920	1.800	18	19	6-103904-8
		1.895	1.820	1.700	17	18	6-103904-7
		1.795	1.720	1.600	16	17	6-103904-6
		1.695	1.620	1.500	15	16	6-103904-5
		1.595	1.520	1.400	14	15	6-103904-4
		1.495	1.420	1.300	13	14	6-103904-3
		1.395	1.320	1.200	12	13	6-103904-2
		1.295	1.220	1.100	11	12	6-103904-1
		1.195	1.120	1.000	10	11	6-103904-0
		1.095	1.020	.900	9	10	5-103904-9
		.995	.920	.800	8	9	5-103904-8
		.895	.820	.700	7	8	5-103904-7
		.795	.720	.600	6	7	5-103904-6
		.695	.620	.500	5	6	5-103904-5
		.595	.520	.400	4	5	5-103904-4
		.495	.420	.300	3	4	5-103904-3
		.395	.320	.200	2	3	5-103904-2
		.295	.220	.100	1	2	5-103904-1
		2.595	2.520	2.400	24	25	2-103904-4
		2.495	2.420	2.300	23	24	2-103904-3
		2.395	2.320	2.200	22	23	2-103904-2
		2.295	2.220	2.100	21	22	2-103904-1
		2.195	2.120	2.000	20	21	2-103904-0
		2.095	2.020	1.900	19	20	1-103904-9
		1.995	1.920	1.800	18	19	1-103904-8
		1.895	1.820	1.700	17	18	1-103904-7
		1.795	1.720	1.600	16	17	1-103904-6
		1.695	1.620	1.500	15	16	1-103904-5
		1.595	1.520	1.400	14	15	1-103904-4
		1.495	1.420	1.300	13	14	1-103904-3
		1.395	1.320	1.200	12	13	1-103904-2
		1.295	1.220	1.100	11	12	1-103904-1
		1.195	1.120	1.000	10	11	1-103904-0
		1.095	1.020	.900	9	10	103904-9
		.995	.920	.800	8	9	103904-8
		.895	.820	.700	7	8	103904-7
		.795	.720	.600	6	7	103904-6
		.695	.620	.500	5	6	103904-5
		.595	.520	.400	4	5	103904-4
		.495	.420	.300	3	4	103904-3
		.395	.320	.200	2	3	103904-2
		.295	.220	.100	1	2	103904-1

9 SUPERCEDED BY 6-103904-2

THIS DRAWING IS A CONTROLLED DOCUMENT. DWN E. BRANDBERG 5-17-93
DRW J. GESFORD 5-17-93

STE TE Connectivity

PRODUCT SPEC: 108-25034
APPLICATION SPEC: ---

SIZE: A1 CAGE CODE: 00779 DRAWING NO: 103904
SCALE: 4:1 SHEET 1 OF 1 REV S

MATERIAL: 1 SEE TABLE WEIGHT: ---

CUSTOMER DRAWING

Mouser Electronics

Authorized Distributor

Click to View Pricing, Inventory, Delivery & Lifecycle Information:

[TE Connectivity:](#)

[5-103904-1](#)