

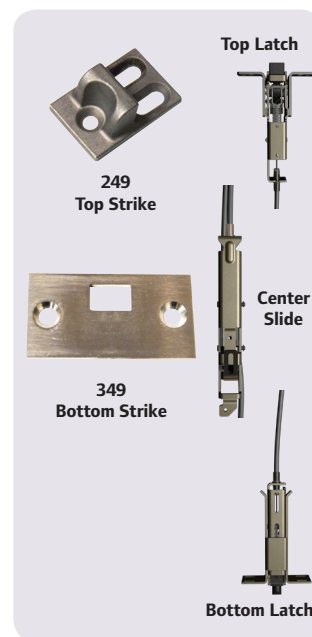

Hex key dogging comes standard on 9849/9949 Concealed Vertical Cable Devices



9849/9949 concealed vertical cable device for use on single or metal doors, UL listed for Panic Exit Hardware. Devices are ANSI A156.3 – 2001 Grade 1. The 9849 device has a smooth mechanism case and the 9949 device has a grooved case. The concealed vertical cable device is non-handed except when the following device options are used: SD (Special Dogging), or SS (Signal Switch). See Opposite page for available outside trim and device functions.

Finishes – US3, US3A, US4, US4A, US10, US15, US26, US26D, US26D-AM Antimicrobial, US28, 313, 315 & 643E. US32D available with 98 Series only.

Specifications

Device Functions	Device ships EO/DT/NL. Field selectable. For TP, K or L remove NL drive screw from device.
Device Lengths	2' 2' (610mm) Door Size 3' 2'4" to 3' (711mm to 914 mm) Door Size 4' 2'10" to 4' (864 mm to 1219 mm) Door Size
Device Centerline from Finished Floor	39 5/8" (1006 mm) Standard
Center Case Dimensions	8" x 2 3/4" x 2 3/8" (203mm x 70mm x 60mm)
Mechanism Case Dimensions	2 1/4" x 2 1/4" (57mm x 57mm)
Projection	Pushbar Neutral – 3 13/16" (97 mm) Pushbar Depressed – 3 1/16" (78 mm)
Latch Bolt	Deadlocking Top & Bottom Bolt, 1/2" (13mm) throw
Door Undercut	3/4" (19mm) maximum
Top & Bottom Latch Case	5 13/16" x 1 1/4" x 1 7/16" (147mm x 32mm x 37mm)
Vertical Cable	7/32" (6mm) Diameter Stainless Steel Cables
Fasteners & Sex Bolts (SNB)	Includes screw pack for 1 3/4" (44mm) and 2 1/4" (57mm) thick metal doors. Optional 425 SNB available.
Electric Options	ALK Alarm Exit Kit CX Chexit Delayed Exit E Electric Unlocking and Locking Trim EL Electric Latch Retraction HD-EL Electric Latch Retraction w/ Hex Dogging LX Latchbolt Monitor Switch QEL Quiet Electric Latch Retraction RX2 Double Pushpad Monitor Switch RX996L Trim Monitor Switch RX Pushpad Monitor Switch RXLC Pushpad Monitor Switch - Low Current SS Signal Switch WP-RX Waterproof Request to Exit
Mechanical Options	GBK Glass Bead Kit LBL Less Bottom Latch PN Pneumatic Latch Retraction SEC Security Screws SG Safety Glow SLM SLM Blocking SNB Sex Bolts
Dogging Feature	Hex key dogging standard
Dogging Options	CD Cylinder Dogging LD Less Dogging SD Special Center Case Dogging DI Dogging Indicator CDI Cylinder Dogging Indicator
Strikes	Top - 249 - Unfinished, Bottom - 349 - Unfinished

QEL
Quiet Electric Latch Retraction

- Bolt retraction via switch
- Converts exit door to push-pull operation

CD
Cylinder Dogging

- Replaces hex key dogging
- Requires standard 1 1/4" mortise cylinder

CX
Chexit Delayed Exit

- Meets NFPA 101 requirements
- Self-contained controls, locking, alarm

RX
Pushpad Monitor Switch

- Signals use of an opening
- SPDT switch to monitor pushpad

EL
Electric Latch Retraction

- Enables remote unlatching
- Alternative to manual dogging

ALK
Alarm Exit Kit

- Unauthorized opening triggers 85-decibel horn
- Set in armed or disarmed mode by key

PN
Pneumatic Latch Retraction

- For areas where electrical devices banned
- Special linkage for mechanical or pneumatic dogging

DI
Dogging Indicator

- Monitor dogging status without a control panel
- Red indicator light shows visibility to dogging from over 75 feet

E (E 996L)
Electrified Breakaway Lever



- Electrified remote locking/unlocking
- Standard in fail safe condition





SG
Safety Glow



- Self illuminating touchpad
- No batteries or electronics

9849/9949 Concealed Vertical Cable Device

Standard Trim

	EO	DT	NL	NL-OP
				
	Exit only	Dummy Trim Pull When Dogged	Night Latch Key Retracts Latchbolt	Night Latch Key Retracts Latchbolt Optional Pull Required
Product Description	9849EO 9949EO	9849DT 9949DT	9849NL 9949NL	9849NL-OP 9949NL-OP
Trim Description	—	990DT	990NL-R/V	110NL-MD
Escutcheon Plate Size	—	3" x 14 ³ / ₁₆ " x ³ / ₃₂ " (76x360x2mm)	3" x 14 ³ / ₁₆ " x ³ / ₃₂ " (76x360x2mm)	—
Pull Center to Center	—	5 ¹ / ₂ " (140mm)	5 ¹ / ₂ " (140mm)	—
Projection	—	2" (51mm)	2" (51mm)	—
ANSI Function	01	02	03	03
Cylinder Type	—	—	Rim	Rim
Handing	—	—	—	—
Optional Trim <i>see pages 44-46</i>	x990EO x996EO	x996K-DT x996L-DT x697DT	x996K-NL x996L-NL x697NL	
Quantity needed Optional 425 SNB	6	2	2	6

	L	L-NL	L-BE	L-DT
				
	Lever Key Locks & Unlocks	Lever - Night Latch Key Retracts Latchbolt	Lever - Blank Escutcheon Always operable (No Cylinder)	Lever Dummy Trim Pull When Dogged
Product Description	9849L 9949L	9849L-NL 9949L-NL	9849L-BE 9959L-BE	9849L-DT 9949 L-DT
Trim Description	996L-R/V*	996L-NL-R/V	996L-BE-R/V*	996L-DT
Escutcheon Plate Size	2 ³ / ₄ " X 10 ³ / ₄ " X ²⁷ / ₃₂ " (70x273x21mm)	2 ³ / ₄ " X 10 ³ / ₄ " X ²⁷ / ₃₂ " (70x273x21mm)	2 ³ / ₄ " X 10 ³ / ₄ " X ²⁷ / ₃₂ " (70x273x21mm)	2 ³ / ₄ " X 10 ³ / ₄ " X ²⁷ / ₃₂ " (70x273x21mm)
Pull Center to Center	—	—	—	—
Projection	2 ⁷ / ₈ " (73mm)	2 ⁷ / ₈ " (73mm)	2 ⁷ / ₈ " (73mm)	2 ⁷ / ₈ " (73mm)
ANSI Function	08	03	14	02
Cylinder Type	Rim	Rim	—	—
Handing	Handed/Reversible	Handed/Reversible	Handed/Reversible	Handed/Reversible
Quantity needed Optional 425 SNB	2	2	2	2

Optional Trim
 Knobs
 Thumbpieces
 Lever Designs

* Electrified lever operation available.

Standard Door Height	
Feet	Inches
6'8"	80"
7'	84"
8'	96"
9'	108"
10'	120"

Note:

Non-standard sizes available with extended lead time.
Consult Customer Care for more information 1-877-671-7011.



9849-F/9949-F fire exit concealed vertical cable device for use on pairs of doors up to 8' x 10' (2438mm x 3048mm), UL listed for Fire Exit Hardware. See page 61 for detailed information on UL listed fire exit hardware label and door opening size information. Devices are ANSI A156.3 – 2001 Grade 1. The 9849-F device has a smooth mechanism case and the 9949-F device has a grooved case. The concealed vertical cable device is non-handed except when the following device option is used: SS (Signal Switch) devices. See Opposite page for available outside trim and functions.

Finishes – US3, US3A, US4, US4A, US10, US15, US26, US26D, US26D-AM Antimicrobial, US28, 313, 315 & 643E. US32D available with 98 Series only.

Specifications

Device Functions	Device ships EO/DT/NL. Field selectable. For TP, K or L remove NL drive screw from device.
Device Lengths	2' 2' (610mm) Door Size 3' 2'4" to 3' (711mm to 914 mm) Door Size 4' 2'10" to 4' (864 mm to 1219 mm) Door Size
Device Centerline from Finished Floor	39 5/8" (1006 mm) Standard Adjustable from 35 5/8" (905mm) to 49 5/8" (1260mm)
Center Case Dimensions	8" x 2 3/4" x 2 3/8" (203mm x 70mm x 60mm)
Mechanism Case Dimensions	2 1/4" x 2 1/4" (57mm x 57mm)
Projection	Pushbar Neutral – 3 13/16" (97 mm) Pushbar Depressed – 3 1/16" (78 mm)
Latch Bolt	Deadlocking Anti-friction Top & Bottom Bolt, 1/2" (13mm) throw
Door Undercut	3/4" (19mm) maximum
Top & Bottom Latch Case	5 13/16" x 1 1/4" x 1 7/16" (147mm x 32mm x 37mm)
Vertical Cable	7/32" (6mm) Diameter Stainless Steel Cables
Fasteners & Sex Bolts (SNB)	Includes screw pack for 1 3/4" (44mm) and 2 1/4" (57mm) thick metal doors. Optional 425 SNB available.
Electric Options	ALK Alarm Exit Kit CX Chexit Delayed Exit E Electric Unlocking and Locking Trim EL Electric Latch Retraction HD-EL Electric Latch Retraction w/ Hex Dogging LX Latchbolt Monitor Switch QEL Quiet Electric Latch Retraction RX2 Double Pushpad Monitor Switch RX996L Trim Monitor Switch RX Pushpad Monitor Switch RXLC Pushpad Monitor Switch - Low Current SS Signal Switch WP-RX Waterproof Request to Exit
Mechanical Options	GBK Glass Bead Kit LBL Less Bottom Latch PN Pneumatic Latch Retraction SEC Security Screws SG Safety Glow SLM SLM Blocking SNB Sex Bolts
Dogging Feature	No mechanical dogging. EL and QEL option available.
Dogging Options	
Strikes	Top - 249 - Unfinished, Bottom - 349 - Unfinished

QEL
Quiet Electric Latch Retraction
 • Bolt retraction via switch
 • Converts exit door to push-pull operation

RX
Pushpad Monitor Switch
 • Signals use of an opening
 • SPDT switch to monitor pushpad

CX
Chexit Delayed Exit
 • Meets NFPA 101 requirements
 • Self-contained controls, locking, alarm

ALK
Alarm Exit Kit
 • Unauthorized opening triggers 85-decibel horn
 • Set in armed or disarmed mode by key

EL
Electric Latch Retraction
 • Enables remote unlatching
 • Alternative to manual dogging



SG
Safety Glow
 • Shows exit door location in darkness or smoke
 • Developed to meet MEA standards





PN
Pneumatic Latch Retraction
 • For areas where electrical devices banned
 • Special linkage for mechanical or pneumatic dogging



SS
Signal Switch
 • Signals unauthorized use of an opening
 • Switch makes latch bolt tamper-resistant

E (E 996L)
Electrified Breakaway Lever
 • Electrified remote locking/unlocking
 • Standard in fail safe condition

Standard Trim

	EO	DT	NL	NL-OP
				
	Exit only	Dummy Trim Pull When Dogged (Not recommended for fire device)	Night Latch Key Retracts Latchbolt	Night Latch Key Retracts Latchbolt Optional Pull Required
Product Description	9849EO-F 9949EO-F	— —	9849NL-F 9949NL-F	9849NL-OP-F 9949NL-OP-F
Trim Description	—	990DT	990NL-R/V	110NL-MD
Escutcheon Plate Size	—	3" x 14 ³ / ₁₆ " x ³ / ₃₂ " (76x360x2mm)	3" x 14 ³ / ₁₆ " x ³ / ₃₂ " (76x360x2mm)	—
Pull Center to Center	—	5 ¹ / ₂ " (140mm)	5 ¹ / ₂ " (140mm)	—
Projection	—	2" (51mm)	2" (51mm)	—
ANSI Function	01	02	03	03
Cylinder Type	—	—	Rim	Rim
Handing	—	—	—	—
Optional Trim see pages 44-46	x990EO x996EO	x996K-DT x996L-DT x696DT x697DT	x996K-NL x996L-NL x696NL x697NL	
Quantity needed Optional 425 SNB	6	2	2	6

	L	L-NL	L-BE	L-DT
				
	Lever Key Locks & Unlocks	Lever - Night Latch Key Retracts Latchbolt	Lever - Blank Escutcheon Always operable (No Cylinder)	Lever Dummy Trim Pull When Dogged (Not recommended for fire device)
Product Description	9849L-F 9949L-F	9849L-NL-F 9949L-NL-F	9849L-BE-F 9959L-BE-F	— —
Trim Description	996L-R/V*	996L-NL-R/V	996L-BE-R/V*	996L-DT
Escutcheon Plate Size	2 ³ / ₄ " X 10 ³ / ₄ " X ²⁷ / ₃₂ " (70x273x21mm)	2 ³ / ₄ " X 10 ³ / ₄ " X ²⁷ / ₃₂ " (70x273x21mm)	2 ³ / ₄ " X 10 ³ / ₄ " X ²⁷ / ₃₂ " (70x273x21mm)	2 ³ / ₄ " X 10 ³ / ₄ " X ²⁷ / ₃₂ " (70x273x21mm)
Pull Center to Center	—	—	—	—
Projection	2 ⁷ / ₈ " (73mm)	2 ⁷ / ₈ " (73mm)	2 ⁷ / ₈ " (73mm)	2 ⁷ / ₈ " (73mm)
ANSI Function	08	03	14	02
Cylinder Type	Rim	Rim	—	—
Handing	Handed/Reversible	Handed/Reversible	Handed/Reversible	Handed/Reversible
Quantity needed Optional 425 SNB	2	2	2	2

Optional Trim
 Knobs
 Thumbpieces
 Lever Designs

* Electrified lever operation available.

Standard Door Height	
Feet	Inches
6'8"	80"
7'	84"
8'	96"
9'	108"
10'	120"

Note:

Non-standard sizes available with extended lead time.
Consult Customer Care for more information 1-877-671-7011.

9849WDC/9949WDC

VON DUPRIN

Wood Door Concealed Vertical Cable Device



Hex key dogging comes standard on 9849/9949 Wood Door Concealed Vertical Cable Devices

9849WDC/9949WDC concealed vertical cable device for use on single or double wood doors, UL listed for Panic Exit Hardware. Devices are ANSI A156.3 – 2001 Grade 1. The 9847WDC device has a smooth mechanism case and the 9947WDC device has a grooved case. The concealed vertical cable device is non-handed except when the following device options are used: SD (Special Dogging), or SS (Signal Switch). See Opposite page for available outside trim and functions.

Scalp Plate – Device is furnished standard with an 8" (203mm) long scalp plate for easy access to rods. *Note: Do not use on pair of doors with 9875/9975.*

Finishes – US3, US3A, US4, US4A, US10, US15, US26, US26D, US26D-AM Antimicrobial, US28, 313, 315 & 643E. US32D available with 98 Series only.



Specifications	
Device Functions	Device ships EO/DT/NL. Field selectable. For TP, K or L remove NL drive screw from device.
Device Lengths	2' 2' (610mm) Door Size 3' 2'4" to 3' (711mm to 914 mm) Door Size 4' 2'10" to 4' (864 mm to 1219 mm) Door Size
Device Centerline from Finished Floor	39 13/16" (1006 mm) Standard Adjustable from 35 5/8" (905mm) to 49 5/8" (1260mm)
Center Case Dimensions	8" x 2 3/4" x 2 3/8" (203mm x 70mm x 60mm)
Mechanism Case Dimensions	2 1/4" x 2 1/4" (57mm x 57mm)
Projection	Pushbar Neutral – 3 13/16" (97 mm) Pushbar Depressed – 3 1/16" (78 mm)
Latch Bolt	Deadlocking Top & Bottom Bolt, 1 1/2" (38mm) throw
Door Undercut	3/4" (19mm) maximum
Top & Bottom Latch Case	5 13/16" x 1 1/4" x 1 7/16" (147mm x 32mm x 37mm)
Vertical Cables	7/32" (6mm) Diameter Stainless Steel Cables
Fasteners & Sex Bolts (SNB)	Includes screw pack for 1 3/4" (44mm) and 2 1/4" (57mm) thick wood doors. 425 SNB <i>required</i> on wood doors without SLM blocking.
Electric Options	ALK Alarm Exit Kit CX Chexit Delayed Exit E Electric Unlocking and Locking Trim EL Electric Latch Retraction HD-EL Electric Latch Retraction w/ Hex Dogging LX Latchbolt Monitor Switch QEL Quiet Electric Latch Retraction RX2 Double Pushpad Monitor Switch RX996L Trim Monitor Switch RX Pushpad Monitor Switch RXLC Pushpad Monitor Switch - Low Current SS Signal Switch WP-RX Waterproof Request to Exit
Mechanical Options	GBK Glass Bead Kit LBL Less Bottom Latch PN Pneumatic Latch Retraction SEC Security Screws SG Safety Glow SLM SLM Blocking SNB Sex Bolts
Dogging Feature	Hex key dogging standard
Dogging Options	CD Cylinder Dogging SD Special Center Case Dogging LD Less Dogging DI Dogging Indicator CDI Cylinder Dogging Indicator
Strikes	Top – 249 – Unfinished, Bottom – 349 – Unfinished

QEL
Quiet Electric Latch Retraction
• Bolt retraction via switch
• Converts exit door to push-pull operation

CD
Cylinder Dogging
• Replaces hex key dogging
• Requires standard 1 1/4" mortise cylinder

CX
Chexit Delayed Exit
• Meets NFPA 101 requirements
• Self-contained controls, locking, alarm

RX
Pushpad Monitor Switch
• Signals use of an opening
• SPDT switch to monitor pushpad

EL
Electric Latch Retraction
• Enables remote unlatching
• Alternative to manual dogging

ALK
Alarm Exit Kit
• Unauthorized opening triggers 85-decibel horn
• Set in armed or disarmed mode by key



PN
Pneumatic Latch Retraction
• For areas where electrical devices banned
• Special linkage for mechanical or pneumatic dogging





LX
Latchbolt Monitor Switch
• Signals use of an opening
• SPDT switch to monitor latch bolt

E (E 996L)
Electrified Breakaway Lever
• Electrified remote locking/unlocking
• Standard in fail safe condition

9849/9949 Wood Door Concealed Vertical Cable Device

Standard Trim

	EO	DT	NL	NL-OP
				
	Exit only	Dummy Trim Pull When Dogged	Night Latch Key Retracts Latchbolt	Night Latch Key Retracts Latchbolt Optional Pull Required
Product Description	9849WDC-EO 9949WDC-EO	9849WDC-DT 9949WDC-DT	9849WDC-NL 9949WDC-NL	9849WDC-NL-OP 9949WDC-NL-OP
Trim Description	—	990DT	990NL-R/V	110NL-WD
Escutcheon Plate Size	—	3" x 14 ³ / ₁₆ " x ⁹ / ₃₂ " (76x360x2mm)	3" x 14 ³ / ₁₆ " x ⁹ / ₃₂ " (76x360x2mm)	—
Pull Center to Center	—	5 ¹ / ₂ " (140mm)	5 ¹ / ₂ " (140mm)	—
Projection	—	2" (51mm)	2" (51mm)	—
ANSI Function	01	02	03	03
Cylinder Type	—	—	Rim	Rim
Handing	—	—	—	—
Optional Trim <i>see pages 44-46</i>	x990EO x996EO	x996K-DT x996L-DT x696DT x697DT	x996K-NL x996L-NL x696NL x697NL	
Quantity needed Optional 425 SNB	6	2	2	6

	L	L-NL	L-BE	L-DT
				
	Lever Key Locks & Unlocks	Lever - Night Latch Key Retracts Latchbolt	Lever - Blank Escutcheon Always operable (No Cylinder)	Lever Dummy Trim Pull When Dogged
Product Description	9849WDC-L 9949WDC-L	9849WDC-L-NL 9949WDC-L-NL	9849WDC-L-BE 9949WDC-L-BE	9849WDC-L-DT 9949WDC-L-DT
Trim Description	996L-R/V*	996L-NL-R/V	996L-BE-R/V*	996L-DT
Escutcheon Plate Size	2 ³ / ₄ " X 10 ³ / ₄ " X ²⁷ / ₃₂ " (70x273x21mm)	2 ³ / ₄ " X 10 ³ / ₄ " X ²⁷ / ₃₂ " (70x273x21mm)	2 ³ / ₄ " X 10 ³ / ₄ " X ²⁷ / ₃₂ " (70x273x21mm)	2 ³ / ₄ " X 10 ³ / ₄ " X ²⁷ / ₃₂ " (70x273x21mm)
Pull Center to Center	—	—	—	—
Projection	2 ⁷ / ₈ " (73mm)	2 ⁷ / ₈ " (73mm)	2 ⁷ / ₈ " (73mm)	2 ⁷ / ₈ " (73mm)
ANSI Function	08	03	14	02
Cylinder Type	Rim	Rim	—	—
Handing	Handed/Reversible	Handed/Reversible	Handed/Reversible	Handed/Reversible
Quantity needed Optional 425 SNB	2	2	2	2

* Electrified lever operation available.

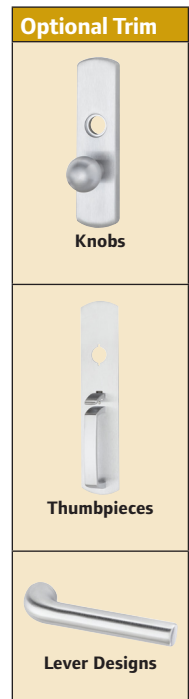

Standard Door Height	
Feet	Inches
6'8"	80"
7'	84"
8'	96"
9'	108"
10'	120"

Note:

Non-standard sizes available with extended lead time.
Consult Customer Care for more information 1-877-671-7011.

9849WDC-F/9949WDC-F

VON DUPRIN

Wood Door Concealed Vertical Cable Fire Device



9849WDC-F/9949WDC-F fire exit concealed vertical cable device for use on pairs of doors up to 8' x 9' 3" (2438mm x 2819mm) double wood doors, UL listed for Fire Exit Hardware. See page 61 for detailed information on UL listed fire exit hardware label and door opening size information. Devices are ANSI A156.3 – 2001 Grade 1. The 9849WDC-F device has a smooth mechanism case and the 9949WDC-F device has a grooved case. The concealed vertical cable device is non-handed except when the following device options are used: SS (Signal Switch). See Opposite page for available outside trim and functions.

Scalp Plate – Device is furnished standard with an 8" (203mm) long scalp plate for easy access to rods.
Note: Do not use on pair of doors with 9975.

Finishes – US3, US3A, US4, US4A, US10, US15, US26, US26D, US26D-AM Antimicrobial, US28, 313, 315 & 643E. US32D available with 98 Series only.

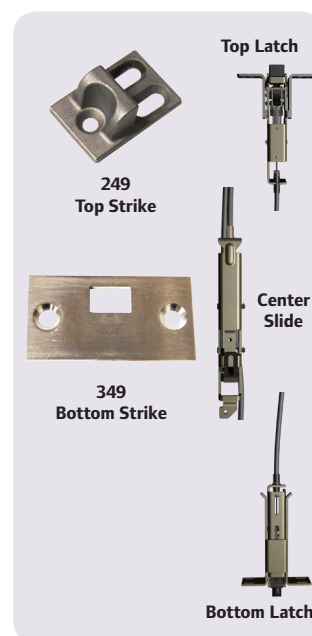

Specifications

Device Functions	Device ships EO/DT/NL. Field selectable. For TP, K or L remove NL drive screw from device.
Device Lengths	2' 2' (610mm) Door Size 3' 2'4" to 3' (711mm to 914 mm) Door Size 4' 2'10" to 4' (864 mm to 1219 mm) Door Size
Device Centerline from Finished Floor	39 13/16" (1006 mm) Standard
Center Case Dimensions	8" x 2 3/4" x 2 3/8" (203mm x 70mm x 60mm)
Mechanism Case Dimensions	2 1/4" x 2 1/4" (57mm x 57mm)
Projection	Pushbar Neutral – 3 13/16" (97 mm) Pushbar Depressed – 3 1/16" (78 mm)
Latch Bolt	Deadlocking Top & Bottom Bolt, 1 1/2" (38mm) throw
Door Undercut	3/4" (19mm) maximum
Top & Bottom Latch Case	5 13/16" x 1 1/4" x 1 7/16" (147mm x 32mm x 37mm)
Vertical Rods	7/32" (6mm) Diameter Stainless Steel Cables
Fasteners & Sex Bolts (SNB)	Includes screw pack for 1 3/4" (44mm) and 2 1/4" (57mm) thick wood doors. 425 SNB <i>required</i> on wood doors without SLM blocking.
Electric Options	ALK Alarm Exit Kit CX Chexit Delayed Exit E Electric Unlocking and Locking Trim EL Electric Latch Retraction HD-EL Electric Latch Retraction w/ Hex Dogging LX Latchbolt Monitor Switch QEL Quiet Electric Latch Retraction RX2 Double Pushpad Monitor Switch RX996L Trim Monitor Switch RX Pushpad Monitor Switch RXLC Pushpad Monitor Switch - Low Current SS Signal Switch WP-RX Waterproof Request to Exit
Mechanical Options	GBK Glass Bead Kit LBL Less Bottom Latch PN Pneumatic Latch Retraction SEC Security Screws SG Safety Glow SLM SLM Blocking SNB Sex Bolts
Dogging Option	No Mechanical Dogging. EL and QEL option available.
Strikes	Top - 249 - Unfinished, Bottom - 349 - Unfinished

QEL
Quiet Electric Latch Retraction
 • Bolt retraction via switch
 • Converts exit door to push-pull operation

RX
Pushpad Monitor Switch
 • Signals use of an opening
 • SPDT switch to monitor pushpad

CX
Chexit Delayed Exit
 • Meets NFPA 101 requirements
 • Self-contained controls, locking, alarm

ALK
Alarm Exit Kit
 • Unauthorized opening triggers 85-decibel horn
 • Set in armed or disarmed mode by key

EL
Electric Latch Retraction
 • Enables remote unlatching
 • Alternative to manual dogging

SG
Safety Glow
 • Shows exit door location in darkness or smoke
 • Developed to meet MEA standards



PN
Pneumatic Latch Retraction
 • For areas where electrical devices banned
 • Special linkage for mechanical or pneumatic dogging





LX
Latchbolt Monitor Switch
 • Signals use of an opening
 • SPDT switch to monitor latch bolt



E (E 996L)
Electrified Breakaway Lever
 • Electrified remote locking/unlocking
 • Standard in fail safe condition

9849WDC-F/9949WDC-F Wood Door Concealed Vertical Cable Fire Device

Standard Trim

	EO	DT 	NL 	NL-OP 
	Exit only	Dummy Trim Pull When Dogged (Not recommended for fire device)	Night Latch Key Retracts Latchbolt	Night Latch Key Retracts Latchbolt Optional Pull Required
Product Description	9849WDC-EO-F 9949WDC-EO-F	— —	9849WDC-NL-F 9949WDC-NL-F	9849WDC-NL-OP-F 9949WDC-NL-OP-F
Trim Description	—	990DT	990NL-R/V	110NL-WD
Escutcheon Plate Size	—	3" x 14 ³ / ₁₆ " x ³ / ₃₂ " (76x360x2mm)	3" x 14 ³ / ₁₆ " x ³ / ₃₂ " (76x360x2mm)	—
Pull Center to Center	—	5 ¹ / ₂ " (140mm)	5 ¹ / ₂ " (140mm)	—
Projection	—	2" (51mm)	2" (51mm)	—
ANSI Function	01	02	03	03
Cylinder Type	—	—	Rim	Rim
Handing	—	—	—	—
Optional Trim see pages 44-46	x990EO x996EO	x996K-DT x996L-DT) x996L-DT x696DT x697DT	x996K-NL x996L-NL x996L-NL x696NL x697NL	
Quantity needed Optional 425 SNB	6	2	2	6

	L 	L-NL 	L-BE 	L-DT 
	Lever Key Locks & Unlocks	Lever - Night Latch Key Retracts Latchbolt	Lever - Blank Escutcheon Always operable (No Cylinder)	Lever Dummy Trim Pull When Dogged (Not recommended for fire device)
Product Description	9849WDC-L-F 9949WDC-L-F	9849WDC-L-NL-F 9949WDC-L-NL-F	9849WDC-L-BE-F 9949WDC-L-BE-F	— —
Trim Description	996L-R/V	996L-NL-R/V	996L-BE-R/V*	996L-DT
Escutcheon Plate Size	2 ³ / ₄ " X 10 ³ / ₄ " X ²⁷ / ₃₂ " (70x273x21mm)	2 ³ / ₄ " X 10 ³ / ₄ " X ²⁷ / ₃₂ " (70x273x21mm)	2 ³ / ₄ " X 10 ³ / ₄ " X ²⁷ / ₃₂ " (70x273x21mm)	2 ³ / ₄ " X 10 ³ / ₄ " X ²⁷ / ₃₂ " (70x273x21mm)
Pull Center to Center	—	—	—	—
Projection	2 ⁷ / ₈ " (73mm)	2 ⁷ / ₈ " (73mm)	2 ⁷ / ₈ " (73mm)	2 ⁷ / ₈ " (73mm)
ANSI Function	08	03	14	02
Cylinder Type	Rim	Rim	—	—
Handing	Handed/Reversible	Handed/Reversible	Handed/Reversible	Handed/Reversible
Quantity needed Optional 425 SNB	2	2	2	2

Optional Trim
 Knobs
 Thumbpieces
 Lever Designs

* Electrified lever operation available.

Standard Door Height	
Feet	Inches
6'8"	80"
7'	84"
8'	96"
9'	108"
10'	120"

Note:

Non-standard sizes available with extended lead time.
Consult Customer Care for more information 1-877-671-7011.