

3349A/3549A Concealed Vertical Cable Device

VON DUPRIN.



3349A and 3549A for all types of single and double doors, UL listed for Panic Exit Hardware. Devices are ANSI A156.3 – 2001 Grade 1. The 3549A has a smooth mechanism case and the 3349A has grooved case. The concealed vertical cable device is non-handed except when the SS (Signal Switch) option is used. See opposite page for available outside trim and device functions.

3349A/3549A fits door stiles as narrow as 2-1/8" (44 mm), wood door stiles as narrow as 4" (102mm). Newly designed device has a one piece center case cover.

Finishes – US3, US3A, US4, US4A, US10, US15 (3549 Only), US26, US26D, US26D-AM Antimicrobial, US28, 313, 315 and 643E.



Specifications

Device Lengths	2' 2' (610mm) Door Size 3' 2'2" to 3' (660mm to 914 mm) Door Size 4' 2'8" to 4' (813 mm to 1219 mm) Door Size
Device Centerline from Finished Floor	39 ⁵ / ₈ " (1006mm) Standard, Adjustable from 35 ⁵ / ₈ " (905mm) to 49 ⁵ / ₈ " (1260mm)
Center Case Dimensions	8 ³ / ₁₆ " x 2 ¹³ / ₃₂ " x 1 ⁹ / ₁₆ " (208mm x 62mm x 40mm)
Mechanism Case Dimensions	2 ¹ / ₄ " x 2 ¹ / ₄ " (57mm x 57mm)
Projection	Pushbar Neutral – 3 ¹³ / ₁₆ " (97 mm) Pushbar Depressed – 3 ¹ / ₁₆ " (78 mm)
Latch Bolt	Deadlocking Anti-friction Top & Bottom Bolt 1/2" (13mm) throw
Door Undercut	3/4" (19mm) Maximum
Top & Bottom Latch	5 ¹³ / ₁₆ " x 1 ¹ / ₄ " x 1 ⁷ / ₁₆ " (147mm x 32mm x 37mm)
Vertical Cables	7/32" (6mm) Diameter Stainless Steel Cables
Fasteners & Sex Bolts (SNB)	Includes 1 ³ / ₄ " (44mm) – 2 ¹ / ₄ " (57mm) Wood & Metal Doors #425 SNB furnished standard for end case #325 SNB furnished standard for EO (exit only device)
Electric Options	ALK Alarm Exit Kit E Electric Locking/Unlocking Trim EL Electric Latch Retraction HD-EL Electric Latch Retraction with Hex Dogging LX Latchbolt Monitor Switch QEL Quiet Electric Latch Retraction RX Pushpad Monitor Switch RXLC Pushpad Monitor Switch - Low Current RX2 Double Pushpad Monitor Switch SS Signal Switch WP-RX Waterproof Pushpad Monitor Switch
Miscellaneous Options	GBK Glass Bead Kit HH Hurricane INS-2 1/2" Insulclad panel INS-4 1/4" Insulclad panel LBL Less Bottom Latch PN Pneumatic Latch Retraction SEC Security Screws SG Safety Glow SNB Sex Bolts
Dogging Feature Dogging Options	Hex key dogging standard CD Cylinder Dogging CDI Cylinder Dogging Indicator DI Dogging Indicator LD Less Dogging
Strikes	Top – 249 , Bottom – 349

QEL

Quiet Electric Latch Retraction

- Bolt retraction via switch
- Converts exit door to push-pull operation

CD

Cylinder Dogging

- Replaces hex key dogging
- Requires standard 1¹/₄" mortise cylinder

CX

Chexit Delayed Exit

- Meets NFPA 101 requirements
- Self-contained controls, locking, alarm

RX

Pushpad Monitor Switch

- Signals use of an opening
- SPDT switch to monitor pushpad

EL

Electric Latch Retraction

- Enables remote unlatching
- Alternative to manual dogging

ALK

Alarm Exit Kit

- Unauthorized opening triggers 85-decibel horn
- Set in armed or disarmed mode by key

PN

Pneumatic Latch Retraction

- For areas where electrical devices banned
- Special linkage for mechanical or pneumatic dogging

DI

Dogging Indicator

- Monitor dogging status without a control panel
- Red indicator light shows visibility to dogging from over 75 feet

E (E360L)

Electric Lever Trim



- Electrified remote locking/unlocking
- Fail safe & fail secure options available





SG

Safety Glow

- Self illuminating touchpad
- No batteries or electronics

Standard Trim

	EO	DT	NL	NL-OP
				
	Exit Only	Dummy Trim Pull when Dogged	Night Latch Key Retracts Latchbolt	Night Latch Key Retracts Latchbolt Optional Pull Required
Product Description	3349A-EO 3549A-EO	3349A-DT 3549A-DT	3349A-NL 3549A-NL	3349A-NL-OP 3549A-NL-OP
Trim Description	—	386DT	386NL	388
Base Size	—	7 ¹⁵ / ₃₂ " x 1 ⁵ / ₈ " (190x41mm)	7 ¹⁵ / ₃₂ " x 1 ⁵ / ₈ " (190x41mm)	7 ¹ / ₂ " x 1 ¹¹ / ₁₆ " (190x43mm)
Grip Size	—	8 ¹ / ₂ " x 4 ⁵ / ₁₆ " (216x110mm)	8 ¹ / ₂ " x 4 ⁵ / ₁₆ " (216x110mm)	—
Projection	—	2 ⁷ / ₁₆ " (62mm)	2 ⁷ / ₁₆ " (62mm)	1" (25mm)
ANSI Function	01	02	03	03
Cylinder Type	—	—	Rim	Rim
Handing	—	—	Handed	—
Optional Trim	—	x 360L-DT x 550DT x IVES 8190	—	x 550DT x IVES 8190 10"

	L	L-BE	T	T-BE
				
	Lever Key Locks and Unlocks	Lever Blank Escutcheon Always Operable (No Cylinder)	Thumbturn Key Locks and Unlocks (Behind C/Case)	Thumbturn Always Operable (No Cylinder) (Behind C/Case)
Product Description	3349A-L 3549A-L	3349A-L-BE 3549A-L-BE	3349A-T 3549A-T	3349A-T-BE 3549A-T-BE
Trim Description	360L	360L-BE	360T	360T-BE
Base Size	7 ¹ / ₂ " x 1 ¹¹ / ₁₆ " x 7 ⁷ / ₈ " (190x43x22mm)	7 ¹ / ₂ " x 1 ¹¹ / ₁₆ " x 7 ⁷ / ₈ " (190x43x22mm)	7 ¹ / ₂ " x 1 ¹¹ / ₁₆ " x 7 ⁷ / ₈ " (190x43x22mm)	7 ¹ / ₂ " x 1 ¹¹ / ₁₆ " x 7 ⁷ / ₈ " (190x43x22mm)
Grip Size	—	—	—	—
Projection	3" (76mm)	3" (76mm)	1 ¹³ / ₁₆ " (46mm)	1 ¹³ / ₁₆ " (46mm)
ANSI Function	08 or 09 Field Selectable	—	11 or 12 Field Selectable	—
Cylinder Type	1 ¹ / ₄ " Mortise	—	1 ¹ / ₄ " Mortise	—
Handing	Handed / Reversible	Handed / Reversible	—	—
Optional Trim	—	E360L-BE	—	E360T-BE

Standard Door Height	
Feet	Inches
6'8"	80"
7'	84"
8'	96"
9'	108"
10'	120"

Note:

Non-standard sizes available with extended lead time.
Consult Customer Care for more information 1-877-671-7011.

3349A-F/3549A-F Fire Exit Concealed Vertical Cable Device **VON DUPRIN**

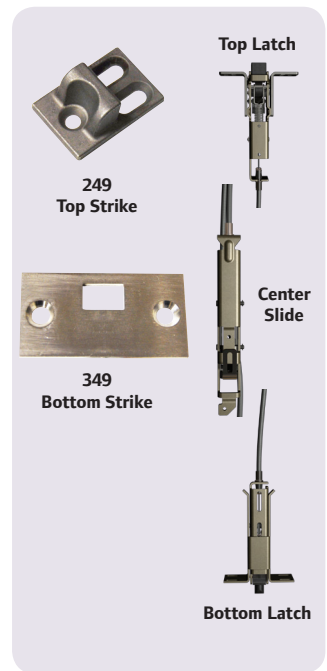

3349A-F and 3549A-F for all types of double doors up to 8' x 10' (2438mm x 2540mm), UL listed for Fire Exit Hardware. **See product catalog for detailed information on UL listed fire exit hardware label and door opening size information.** Devices are ANSI A156.3 – 2001 Grade 1. The 3549A-F has a smooth mechanism case and the 3349A-F has grooved case. The concealed vertical cable device is non-handed except when the SS (Signal Switch) option is used. See opposite page for available outside trim and device functions.

3349A-F/3529A-F fits door stiles as narrow as 3 1/2" (90mm). Newly designed device has a one piece center case cover.

Finishes – US3, US3A, US4, US4A, US10, US15 (3549 Only), US26, US26D, US26D-AM Antimicrobial, US28, 313, 315 and 643E.

Specifications

Device Lengths	2' 2" (610mm) Door Size 3' 2"2" to 3' (660mm to 914 mm) Door Size 4' 2"8" to 4' (813 mm to 1219 mm) Door Size
Device Centerline from Finished Floor	39 5/8" (1006mm) Standard, Adjustable from 35 5/8" (905mm) to 49 5/8" (1260mm)
Center Case Dimensions	8 3/16" x 2 13/32" x 1 9/16" (208mm x 62mm x 40mm)
Mechanism Case Dimensions	2 1/4" x 2 1/4" (57mm x 57mm)
Projection	Pushbar Neutral – 3 13/16" (97 mm) Pushbar Depressed – 3 1/16" (78 mm)
Latch Bolt	Deadlocking Anti-friction Top & Bottom Bolt 1/2" (13mm) throw
Door Undercut	5/8" (16mm) Maximum
Top & Bottom Latch	5 13/16" x 1 1/4" x 1 7/16" (147mm x 32mm x 37mm)
Vertical Cables	7/32" (6mm) Diameter Stainless Steel Cables
Fasteners & Sex Bolts (SNB)	Includes 1 3/4" (44mm) – 2 1/4" (57mm) Wood & Metal Doors #425 SNB furnished standard for end case #325 SNB furnished standard for EO (exit only device)
Electric Options	ALK Alarm Exit Kit E Electric Locking/Unlocking Trim EL Electric Latch Retraction HD-EL Electric Latch Retraction with Hex Dogging LX Latchbolt Monitor Switch QEL Quiet Electric Latch Retraction RX Pushpad Monitor Switch RXLC Pushpad Monitor Switch - Low Current RX2 Double Pushpad Monitor Switch SS Signal Switch WP-RX Waterproof Pushpad Monitor Switch
Miscellaneous Options	GBK Glass Bead Kit HH Hurricane INS-2 1/2" Insulclad panel INS-4 1/4" Insulclad panel LBL Less Bottom Latch PN Pneumatic Latch Retraction SEC Security Screws SG Safety Glow SNB Sex Bolts
Dogging Feature	No mechanical Dogging, EL & QEL option available
Strikes	Top – 249 , Bottom – 349

QEL
Quiet Electric Latch Retraction
• Bolt retraction via switch
• Converts exit door to push-pull operation

RX
Pushpad Monitor Switch
• Signals use of an opening
• SPDT switch to monitor pushpad

CX
Chexit Delayed Exit
• Meets NFPA 101 requirements
• Self-contained controls, locking, alarm

ALK
Alarm Exit Kit
• Unauthorized opening triggers 85-decibel horn
• Set in armed or disarmed mode by key

EL
Electric Latch Retraction
• Enables remote unlatching
• Alternative to manual dogging

DI
Dogging Indicator
• Monitor dogging status without a control panel
• Red indicator light shows visibility to dogging from over 75 feet



PN
Pneumatic Latch Retraction
• For areas where electrical devices banned
• Special linkage for mechanical or pneumatic dogging





SG
Safety Glow
• Self illuminating touchpad
• No batteries or electronics

E (E360L)
Electric Lever Trim
• Electrified remote locking/unlocking
• Fail safe & fail secure options available

3349A-F/3549A-F Fire Exit Concealed Vertical Cable Device

Standard Trim

	EO	DT	NL	NL-OP
				
	Exit Only	Dummy Trim Pull when Dogged	Night Latch Key Retracts Latchbolt	Night Latch Key Retracts Latchbolt Optional Pull Required
Product Description	3349A-EO 3549A-EO	3349A-DT 3549A-DT	3349A-NL 3549A-NL	3349A-NL-OP 3549A-NL-OP
Trim Description	—	386DT	386NL	388
Base Size	—	7 ¹⁵ / ₃₂ " x 1 ⁵ / ₈ " (190x41mm)	7 ¹⁵ / ₃₂ " x 1 ⁵ / ₈ " (190x41mm)	7 ¹ / ₂ " x 1 ¹¹ / ₁₆ " (190x43mm)
Grip Size	—	8 ¹ / ₂ " x 4 ⁵ / ₁₆ " (216x110mm)	8 ¹ / ₂ " x 4 ⁵ / ₁₆ " (216x110mm)	—
Projection	—	2 ⁷ / ₁₆ " (62mm)	2 ⁷ / ₁₆ " (62mm)	1" (25mm)
ANSI Function	01	02	03	03
Cylinder Type	—	—	Rim	Rim
Handing	—	—	Handed	—
Optional Trim	—	x 360L-DT x 550DT x IVES 8190	—	x 550DT x IVES 8190 10"

	L	L-BE	T	T-BE
				
	Lever Key Locks and Unlocks	Lever Blank Escutcheon Always Operable (No Cylinder)	Thumbturn Key Locks and Unlocks (Behind C/Case)	Thumbturn Always Operable (No Cylinder) (Behind C/Case)
Product Description	3349A-L 3549A-L	3349A-L-BE 3549A-L-BE	3349A-T 3549A-T	3349A-T-BE 3549A-T-BE
Trim Description	360L	360L-BE	360T	360T-BE
Base Size	7 ¹ / ₂ " x 1 ¹¹ / ₁₆ " x 7 ⁷ / ₈ " (190x43x22mm)	7 ¹ / ₂ " x 1 ¹¹ / ₁₆ " x 7 ⁷ / ₈ " (190x43x22mm)	7 ¹ / ₂ " x 1 ¹¹ / ₁₆ " x 7 ⁷ / ₈ " (190x43x22mm)	7 ¹ / ₂ " x 1 ¹¹ / ₁₆ " x 7 ⁷ / ₈ " (190x43x22mm)
Grip Size	—	—	—	—
Projection	3" (76mm)	3" (76mm)	1 ¹³ / ₁₆ " (46mm)	1 ¹³ / ₁₆ " (46mm)
ANSI Function	08 or 09 Field Selectable	—	11 or 12 Field Selectable	—
Cylinder Type	1 ¹ / ₄ " Mortise	—	1 ¹ / ₄ " Mortise	—
Handing	Handed / Reversible	Handed / Reversible	—	—
Optional Trim	—	E360L-BE	—	E360T-BE

Standard Door Height	
Feet	Inches
6'8"	80"
7'	84"
8'	96"
9'	108"
10'	120"

Note:

Non-standard sizes available with extended lead time.
Consult Customer Care for more information 1-877-671-7011.