

Product information presented here reflects conditions at time of publication. Consult factory regarding discrepancies or inconsistencies.

MAIL TO: P.O. BOX 16347 • Louisville, KY 40256-0347  
 SHIP TO: 3649 Cane Run Road • Louisville, KY 40211-1961  
 (502) 778-2731 • 1 (800) 928-PUMP • FAX (502) 774-3624

visit our web site:  
[www.zoeller.com](http://www.zoeller.com)

## SUMP/SEWAGE BASINS

### COMPARE THESE FEATURES







- Available in high density polyethylene structural foam, polyethylene or fiberglass.
- Ideal for residential, commercial and industrial applications.
- Complete with necessary sealing hardware and flanges.
- Available with 2" or 3" vent and 2" or 3" discharge.
- Lid with gasket and 4" C. I. inlet hub with anticorrosion coating are included with the sewage basins.
- Centerline of hub is located 10½" from top of basin (std.). Custom locations available.
- Polyethylene sewage pump basins are IAPMO approved. For 10' stack test models, refer to charts on pages 2 and 3.
- Sealed (Radon) basins for sump pumps in 18" x 22" and 18" x 30" sizes.
- Polyethylene sump basin available with plastic non-sealed covers in 18" x 22".
- Sewage basins are watertight and gas-tight when properly installed.
- Durable steel cover with gasket standard on simplex and duplex sewage basins.
- One-piece, seam-free construction on all basins.
- Duplex covers include two pump plates and inspection plate.
- Ready to install for economical and simple installation.
- Dimensional Engineering data available.
- Temperature rated 130°F.
- Fiberglass models available that will pass the 10' water stack test (Refer to charts on pages 2 and 3). (L. A. - RR-5311)
- Various custom diameters & lengths available in fiberglass, consult factory. Also with 10' water stack test.

### CONSULT FACTORY FOR LARGER SIZE BASINS OR SPECIAL APPLICATIONS.

18" SUMP BASIN COVERS ONLY		
One Piece, Polyethylene Molded with 3" x 13" Opening  P/N 17-0135	One Piece, Steel with 3" Vent, 1½" Discharge, and Cord Grommet (Radon Lid)  P/N 17-0131	18" Cover - One Piece, Polyethylene with 1 ½" Discharge and Cord Grommet.  P/N 17-0294
SUMP AND RADON BASINS		SEWAGE BASINS
18" x 22" Heavy Duty Polyethylene, no inlet hole and hub (P/N 31-0444). 18" x 22" Radon basin with inlet and hub (P/N 31-0251). 18" x 30" Poly, 4" inlet-grommet (loose), no inlet hole. Includes one-piece blank poly cover w/cord seal (P/N 31-1855). 		18" x 30" Premium Basin with Split Cover, AFD, Torque Stops, Black.  P/N 31-1606

Products may not be exactly as pictured

**NOTE:** Polyethylene basins should be used for indoor installations only.

SIMPLEX SEWAGE BASINS		DUPLEX SEWAGE BASINS	
18" x 30" 24" x 30"	Polyethylene Structural Foam, Polyethylene or Fiberglass Polyethylene or Fiberglass	30" x 36" 36" x 36" 48" x 48"	Polyethylene or Fiberglass Polyethylene or Fiberglass Fiberglass
			
		 <b>COMBO HUB</b> (Poly Structural Foam Only)	
		 <b>THREE BOLT HUB</b> <b>FOR DWV PIPE</b>	
		 <b>PIPE SEAL HUB</b>	
		 <b>SNAP-IN HUB</b> (Poly Structural Foam Only)	
<b>SIMPLEX BASIN and COVER INCLUDES:</b> Discharge and Vent Flange Cord Seal 4" Inlet Hub - Cast Iron Shown Gaskets and hardware		<b>DUPLEX BASIN AND COVER INCLUDES:</b> Discharge and Vent Flange Cord Seals 4" Inlet Hub Inspection Plate Gaskets and hardware	



**18" & 24" DIAMETER BASIN AND COVERS  
 POLYETHYLENE/POLYETHYLENE STRUCTURAL FOAM/FIBERGLASS**

SIMPLEX BASINS & COVERS								
Size	2" Vent	3" Vent		BASIN		COVERS		4" Inlet
	2" Discharge	2" Discharge	3" Discharge	STYLE	IAPMO LISTED	STYLE	IAPMO CAPABLE	
18" X 30"	31-0081	N/A	N/A	Poly	N	Steel - Split	N	Cast Iron Hub
18" X 30"	31-0091	31-0084	31-0082	Poly	Y	Steel - Solid	N	Cast Iron Hub
18" X 30"	31-0154	31-0157	31-0155	Fiberglass	N	Steel - Split	N	Cast Iron Hub
18" X 30"	31-0159	31-0162	31-0161	Poly	Y	Steel - Solid - 10' Stack	Y	Pipe Seal
18" X 30"	31-0214	31-0217	31-0215	Fiberglass	N	Steel - Solid - 10' Stack	Y	Cast Iron Hub
18" X 30"	31-1649	31-1650	31-1651	Poly Structural Foam, AFD	N	PSF - Solid - 10' Stack	Y	Snap-In Hub
18" X 30"	31-1652	31-1653	31-1654	Poly Structural Foam	N	PSF - Solid - 10' Stack	Y	Combo Hub
18" X 30"	31-1655	31-1656	31-1657	Poly Structural Foam	N	PSF - Solid - 10' Stack	Y	Snap-In Hub
18" X 30"	31-0608	31-0611	31-0609	Poly (Integral Side Vent)	N	Poly - Solid	N	Pipe Seal
18" X 30"	31-0615	N/A	N/A	Poly	Y	Steel - Solid	N	Pipe Seal
18" X 30"	31-1098	N/A	N/A	Poly Structural Foam	N	Poly - Solid	N	Combo Hub
18" X 30"	31-1099	31-1101	31-1100	Poly Structural Foam	N	Poly - Split	N	Combo Hub
18" X 30"	31-1338	31-1338	N/A	Poly Structural Foam	N	Poly - Solid	N	Snap-In Hub
24" X 30"	31-0004	31-0027	31-0006	Fiberglass	N	Steel - Solid	N	Cast Iron Hub
24" X 30"	31-0039	31-0042	31-0040	Poly	N	Steel - Solid	N	Cast Iron Hub
24" X 30"	31-0218	31-0221	31-0219	Fiberglass	N	Steel - Solid - 10' Stack	Y	Cast Iron Hub
24" X 36"	31-1102	31-1104	31-1103	Poly Structural Foam	N	Poly - Split	N	Combo Hub

SUMP BASINS	
Item No.	Description
31-0444	Polyethylene Basin without Hub & Hole - 18" x 22"
31-0251	Polyethylene Basin with Inlet Hole, without Hub - 18" x 22"

SUMP BASIN COVERS	
Item No.	Description
17-0135	18" Cover - One Piece, Polyethylene Molded with 3" x 13" Opening
17-0131	18" Cover - One Piece, Steel with 3" Vent, 1 1/2" Discharge, and Cord Grommet (Radon Lid)
17-0294	18" Cover - One Piece, Polyethylene with 1 1/2" Discharge and Cord Grommet.



## 30", 36" & 48" DIAMETER BASIN AND COVERS - POLYETHYLENE/FIBERGLASS

DUPLIX BASINS & COVERS								
Size	2" Vent		3" Vent		BASIN		COVERS	
	2" Discharge	2" Discharge	3" Discharge	STYLE	IAPMO LISTED	STYLE	IAPMO CAPABLE	4" Inlet
30" X 36"	31-1105	31-1107	31-1106	Structural Foam	N	Solid - FG* - Duplex	N	Combo Hub
30" X 36"	31-0043	31-0046	31-0044	Poly	N	Steel - Solid - Duplex	N	Cast Iron Hub
30" X 36"	31-0071	31-0074	31-0072	Fiberglass	N	Steel - Solid - Duplex	N	Cast Iron Hub
30" X 36"	31-0222	31-0225	31-0223	Fiberglass	N	Steel - Solid - Duplex - 10' Stack	Y	Cast Iron Hub
36" X 36"	31-0047	31-0050	31-0048	Poly	N	Steel - Solid - Duplex	N	Cast Iron Hub
36" X 36"	31-0010	31-0057	31-0011	Fiberglass	N	Steel - Solid - Duplex - 10' Stack	Y	Cast Iron Hub
48" X 48"	31-0124	31-0127	31-0125	Fiberglass	N	Steel - Solid - Duplex - 10' Stack	Y	Cast Iron Hub

Hub Size (Flat Mount - Cast Iron)	Basin Size					
	18"	24"	30"	36"	42"	48"
4"	005198 (Fits all basins with a flat on side)					

Hub Size (Pipe Seal Grommets)	All Basin Sizes	Hole Size Required in Basin
1/4"	008813	2"
1/4"	009838	3"
1/2"	005882	2-1/2"
1/2"	009170	3"
2"	005588	3"
3"	005587	4"
4"	005196	5"
6"	009850	7"

Hub Size (Curved Mount - Cast Iron)	Basin Size					
	18"	24"	30"	36"	42"	48"
2"	010749	010749	010749	010749	010749	010749
3"	010124	010124	010124	010124	010124	010124
4"	NA	004997	004997	004997	004997	004997
5"	NA	010125	010125	010125	010125	010125
6"	NA	007818	007818	007818	007818	007818
8"	NA	010057	010057	010057	010057	010057

Curved mount requires mounting on curved side of basin.

Hub Size (Combo Hub)	Basin Size (Poly structural foam only)		
	18"	24"	30"
3"	013505	013505	013505
4"	012094	012094	012094

**NOTE:** Basins are not designed to be installed where saturated soil hydrostatic pressure extends above the top of the pit unless the pressure is relieved by an independent drainage system. Basin cover vent and discharge seals may be rubber insert or bolted on flange design.

BASIN DIMENSIONS										
Available in:			Size	Gallon Capacity	A	B	C	D	E	
Str. Foam	Poly	Fiber Glass								
x	x	x	18" x 30"	30	30"	16 1/2"	18"	22"	10 1/2"	
NA	x	x	24" x 30"	60	30"	24"	26"	30"	10 1/2"	
x	NA	NA	24" x 36"	72	36"	22 1/2"	25 1/2"	30"	10 1/2"	
NA	x	x	30" x 36"	108	36"	30"	32"	36"	10 1/2"	
NA	x	x	36" x 36"	159	36"	36"	38"	42"	10 1/2"	
NA	NA	x	48" x 48"	376	48"	48"	48 1/2"	55 1/2"	10 1/2"	

THICKNESS OF BASINS			
Size	Structural Foam	Poly	Fiberglass
18" x 30"	0.200	0.200	0.188
24" x 30"	N/A	0.200	0.188
24" x 36"	0.250	N/A	N/A
30" x 36"	0.312	0.230	0.188
36" x 36"	N/A	0.230	0.188
48" x 48"	N/A	N/A	0.250

THICKNESS OF COVERS					
Size	Steel Split	Steel Solid	Poly Solid	Poly Split	Fiberglass
18"	0.075	0.115	0.345	0.312	N/A
24"	N/A	0.115	N/A	0.343	N/A
30"	N/A	0.125	N/A	N/A	0.250
36"	N/A	0.125	N/A	N/A	0.375
48"	N/A	0.250	N/A	N/A	0.500

**CONSULT FACTORY FOR LARGER SIZE BASINS OR SPECIAL APPLICATIONS**

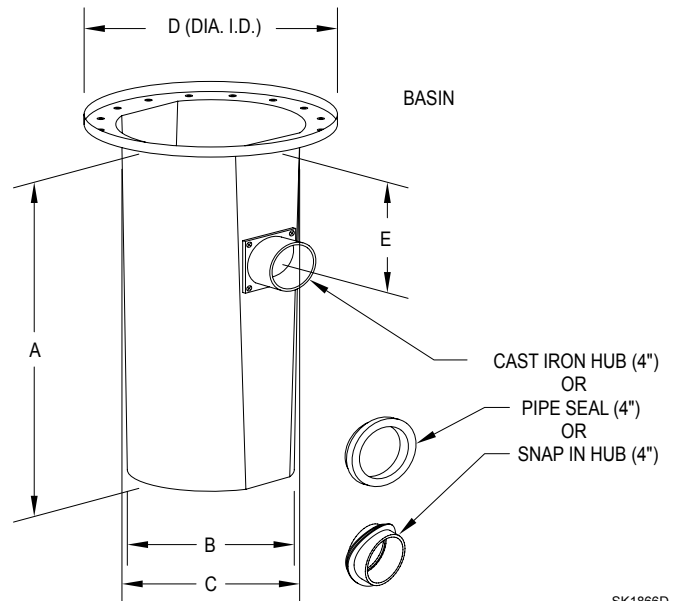

SK1866D

# OUTDOOR BASINS AND ACCESSORIES

## SIMPLEX OUTDOOR BASINS - FIBERGLASS ONLY - NO HOLES DRILLED

Size	Item No.	Description
24" X 48"	31-0866	Solid Fiberglass Basin with Solid Fiberglass Cover and Anti-Flotation Ring
24" X 60"	31-0946	Solid Fiberglass Basin with Solid Fiberglass Cover and Anti-Flotation Ring
24" X 72"	31-0594	Solid Fiberglass Basin with Solid Fiberglass Cover and Anti-Flotation Ring
30" X 48"	31-1830	Solid Fiberglass Basin with Solid Fiberglass Cover and Anti-Flotation Ring
30" X 60"	31-1831	Solid Fiberglass Basin with Solid Fiberglass Cover and Anti-Flotation Ring
30" X 72"	31-1586	Solid Fiberglass Basin with Solid Fiberglass Cover and Anti-Flotation Ring

All basins include 5 field installed adapta-flex seals - (1) 1 1/4", (1) 1 1/2", (2) 2" and (1) 4" grommets.

## DUPLEX OUTDOOR BASINS - FIBERGLASS ONLY - NO HOLES DRILLED

Size	Item No.	Description
36" X 48"	31-1450	Solid Fiberglass Basin with Solid Fiberglass Cover and Anti-Flotation Ring
36" X 60"	31-1451	Solid Fiberglass Basin with Solid Fiberglass Cover and Anti-Flotation Ring
36" X 72"	31-1452	Solid Fiberglass Basin with Solid Fiberglass Cover and Anti-Flotation Ring

All basins include 5 field installed adapta-flex seals - (1) 1 1/4", (1) 1 1/2", (2) 2" and (1) 4" grommets.

ADDITIONAL BASIN SIZES WITH OPTIONS (ie Rail Studs) ARE AVAILABLE. CONSULT FACTORY.

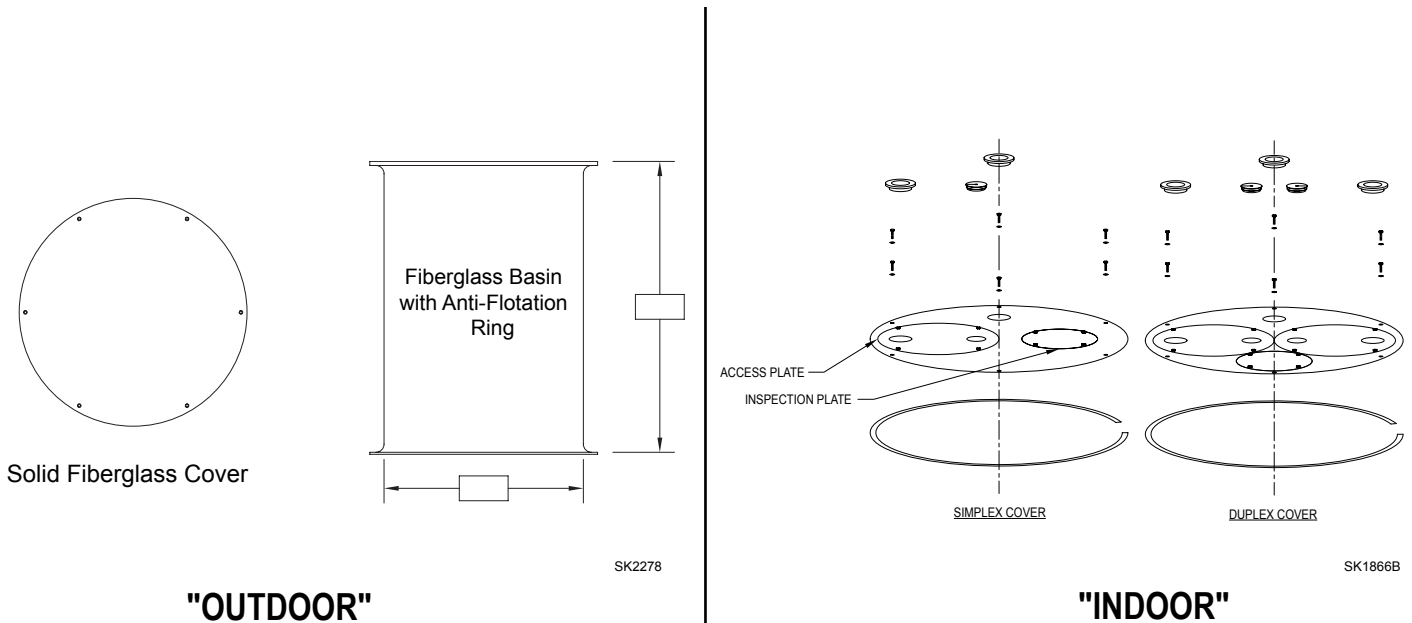

## OUTDOOR TANK VENTS

Item No.	Color	Material	Size	Dimension (W x H)	Pipe Area	Screen Area
10-1753	Black	Plastic	2" Male NPT	4.625" X 3.125"	3.1 sq. in.	6.9 sq. in.
10-1461	Green	Metal	2" Male NPT	4.625" X 3.125"	3.1 sq. in.	6.9 sq. in.
10-1462	Green	Metal	3" Male NPT	6.875" X 4.500"	7.1 sq. in.	19.6 sq. in.
10-1463	Green	Metal	4" Male NPT	9.250" X 5.000"	12.6 sq. in.	35.8 sq. in.
10-1464	Green	Metal	6" Male NPT	11.125" X 6.625"	28.3 sq. in.	42.5 sq. in.



www.zoeller.com

**ZOELLER**  
PUMP CO.

MAIL TO: P.O. BOX 16347  
Louisville, KY 40256-0347  
SHIP TO: 3649 Cane Run Road  
Louisville, KY 40211-1961  
(502) 778-2731 • 1 (800) 928-PUMP  
FAX (502) 774-3624

Manufacturers of..

"QUALITY PUMPS SINCE 1939"