

# Z-FLEX®

Advanced Venting Solutions



# Z-DENS

## Polypropylene Vent Systems

for High Efficiency Condensing Appliances

*Single Wall Rigid • Flexible Liner*

*Cascade • Concentric*

Affirmed as  
replacement to  
comparable PVC  
& CPVC vent on CSA  
listed high efficiency  
condensing  
appliances

Intertek Tested,  
Approved & Listed  
to ULC S636 as a  
Type BH  
Gas Vent System



## Why Z-DENS Polypropylene Vent System

Polypropylene (PP) is comprised of only 2 elements carbon & hydrogen and is made without the use of any toxic or carcinogenic materials, heavy metals or chlorides.

PP is manufactured from propylene monomer, a waste gas of the petroleum industry which used to be burned off increasing greenhouse gases. Therefore the more PP used the LESS greenhouse gases are emitted.

PP has a higher maximum flue gas temperature limit (230°F) as compared to PVC (149°F) & CPVC (194°F). PP is easily 100% recyclable where PVC & CPVC is not due to its chemical composition and various additives.

- PP is environmentally friendly.
- PP has a higher temperature limit and range (working & softening) making it a safer vent material.
- PP is non-toxic.
- PP is more chemically resistant to aromatic hydrocarbons (found in fuels i.e. benzene and toluene) and acids (sulfuric, nitric & hydrochloric) as compared to PVC & CPVC.
- PP will not leach out any chlorides which can attack metal heat exchangers.
- When burned PP releases less smoke and no toxic smoke.

Poly vinyl chloride (PVC) & chlorinated polyvinyl chloride (CPVC) are comprised of 3 elements carbon, hydrogen & chlorine and is made from vinyl chloride monomer (VCM) which is very toxic.

VCM exposure has been linked to rare form of liver cancer, angiosarcoma. EPA has classified vinyl chloride as a Group A, human carcinogen.

To make PVC & CPVC more flexible plasticizers called phthalates are added. Phthalates are carcinogens and can leach out. When burned PVC produces more smoke than PP. When burned (building or back yard fires or incinerated) PVC & CPVC also produce a mixture of highly toxic gases such as hydrogen chloride and dioxins due to the chlorine in PVC & CPVC where PP does not.

### U.S. EPA states:

*"Dioxins are called persistent organic pollutants (POPs), meaning they take a long time to break down once they are in the environment. Dioxins are highly toxic and can cause cancer, reproductive and developmental problems, damage to the immune system and can interfere with hormones."*

PVC also has a lower surface energy and ages faster when compared to PP.

# Table of Contents

Z-DENS Technical Information	1
Z-DENS Direct Vent Application & Drawings	2 - 6
Z-DENS Single Wall Technical Information & Specifications	7
Z-DENS Flexible Technical Information	8
Z-DENS Concentric Technical Information	9
Z-DENS Termination Information	10
Z-DENS 2" Single Wall Rigid Components	11 - 14
Z-DENS 2" Flexible Components	15 - 17
Z-DENS 3" Single Wall Rigid Components	18 - 22
Z-DENS 3" Flexible Components	23 - 25
Z-DENS 4" Single Wall Rigid Components	26 - 31
Z-DENS 4" Flexible Components	32 - 33
Z-DENS 5" Single Wall Rigid Components	34 - 36
Z-DENS 6" Single Wall Rigid Components	37 - 40
Z-DENS 8" Single Wall Rigid Components	41 - 43
Z-DENS Cascade Components	44
Z-DENS 2"/4" Concentric Components	45 - 47
Z-DENS 3"/5" Concentric Components	48 - 50
Z-DENS 4"/6" Concentric Components	51 - 53
Z-DENS Limited Warranty	54
Z-Quote	55
Additional Products	56



## Z-Flex® Joins Forces with Cox Geelen®

**Z-Flex®** North America's leading independent manufacturer of specialty venting systems for over 35 years; has joined forces with Cox Geelen®, one of Europe's leading innovators and manufacturers of polypropylene venting systems.

Cox Geelen's manufacturing roots date back over a century and are recognized today worldwide for their technical knowledge, OEM experience and environmentally responsible business philosophy in the polypropylene venting industry.

**Z-Flex®** is proud to offer this polypropylene venting system, branded Z-DENS, to our highly acclaimed product line-up which includes Z-VENT® and NovaVENT®.

Recent developments in flue systems for use with high efficiency heating appliances, combined with the increased familiarity of use and installer confidence in polypropylene venting systems, has led to the development and continuous improvement of the polypropylene Z-DENS system.

### Designed and Tested Safe

Unlike most PVC and CPVC pipe:

- Z-DENS is specifically designed, tested and listed as a vent system.
- Z-DENS is manufactured from environmentally safe and sustainable fire retardant polypropylene, offering superior performance.
- Z-DENS does not require explosive or toxic cleaners, primers or cements; eliminating the safety and health concerns associated with these products.
- Z-DENS Self-Sealing design does not require any curing time, significantly reducing installation times and allows immediate system start up.
- Z-DENS can be used to vent appliances in New York City where PVC is **NOT PERMITTED**.

Z-DENS is available in diameters 2" (60 mm), 3" (80 mm), 4" (110 mm), 5" (125 mm), 6" (160 mm) and 8" (200 mm). Z-DENS is also fully compatible with Z-DENS FLEXIBLE and Z-DENS CONCENTRIC making for a complete and safe flue gas system.

### Approvals

- Tested and Listed to ULC S636
- Conforms to the UL1738 requirements for category IV condensing appliances
- CE marked according to the European standard EN 14471
- Conforms to Gastec Qa 83-1

### Recyclable

At the end of its life cycle, Z-DENS can be completely recycled.



Z-DENS  
SINGLE WALL  
RIGID



Z-DENS  
CONCENTRIC



Z-DENS FLEXIBLE

# Z-DENS Direct Vent Applications\*

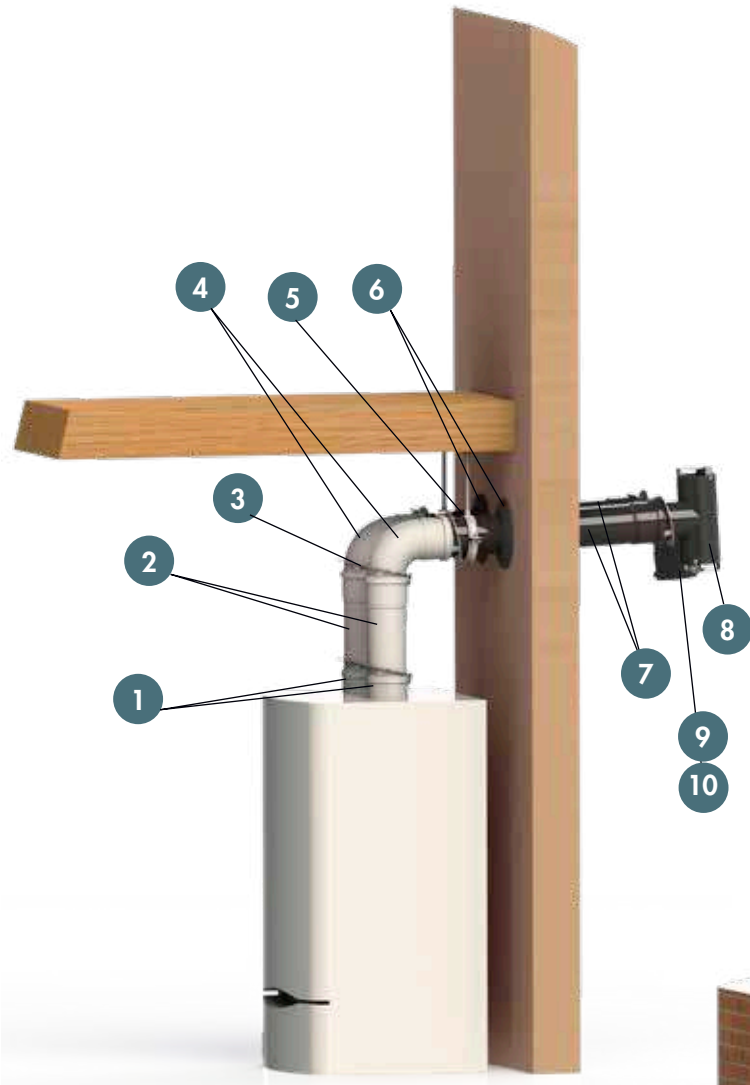

Horizontal Vent and Air - Same Pressure Zone

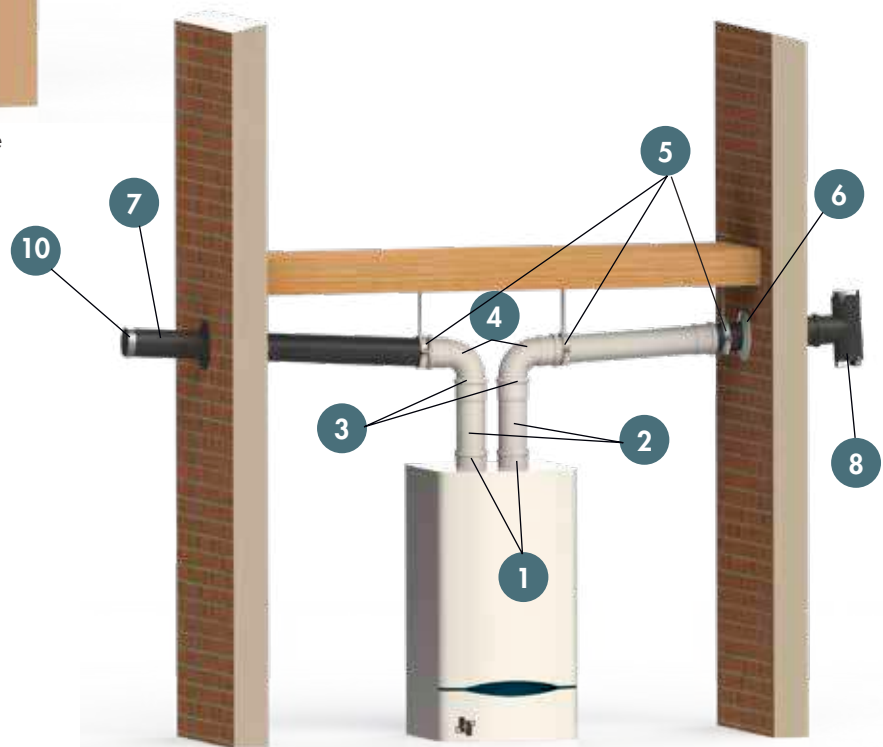

Horizontal Vent and Air - Different Pressure Zones

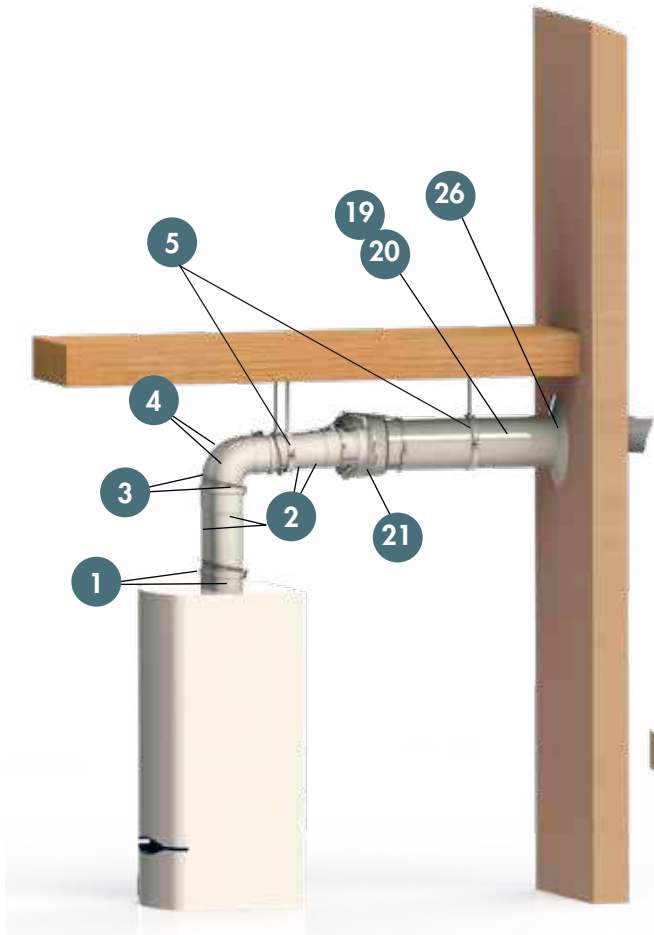

Horizontal Vent and Air with Horizontal Concentric Termination Kit

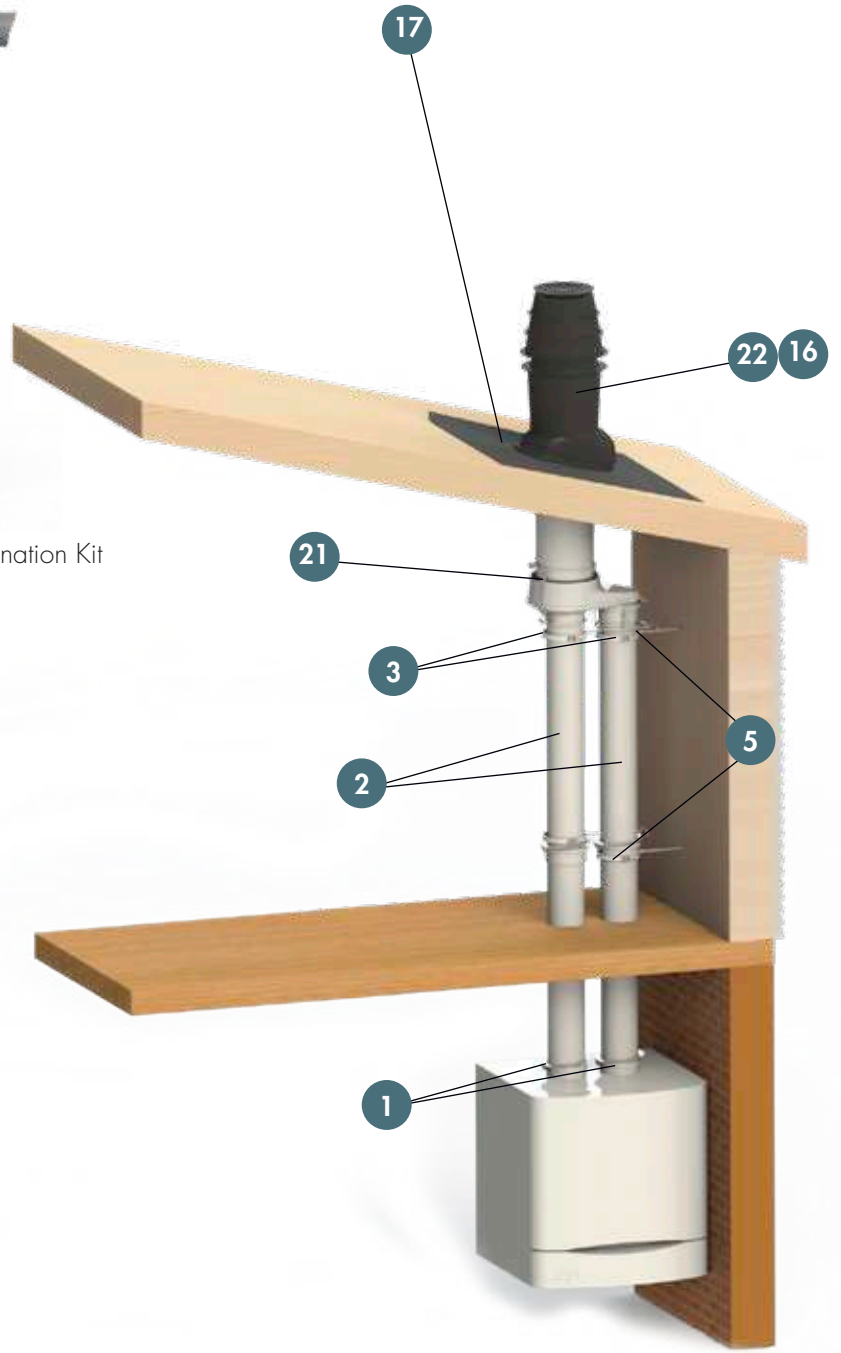

Vertical Vent and Air with Vertical Concentric Termination Kit

# Z-DENS Direct Vent Applications\*

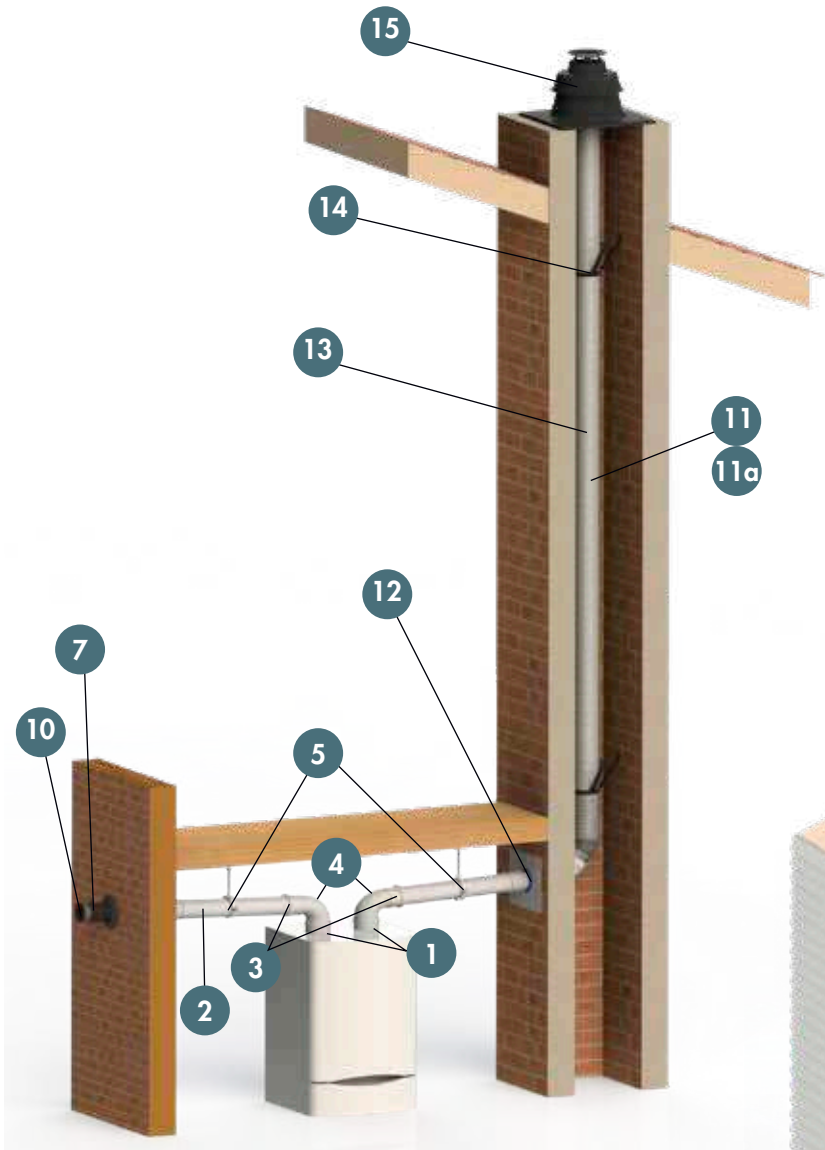

Vertical Flexible Vent in Clean Unused Chimney with Chimney Cover and Horizontal Air

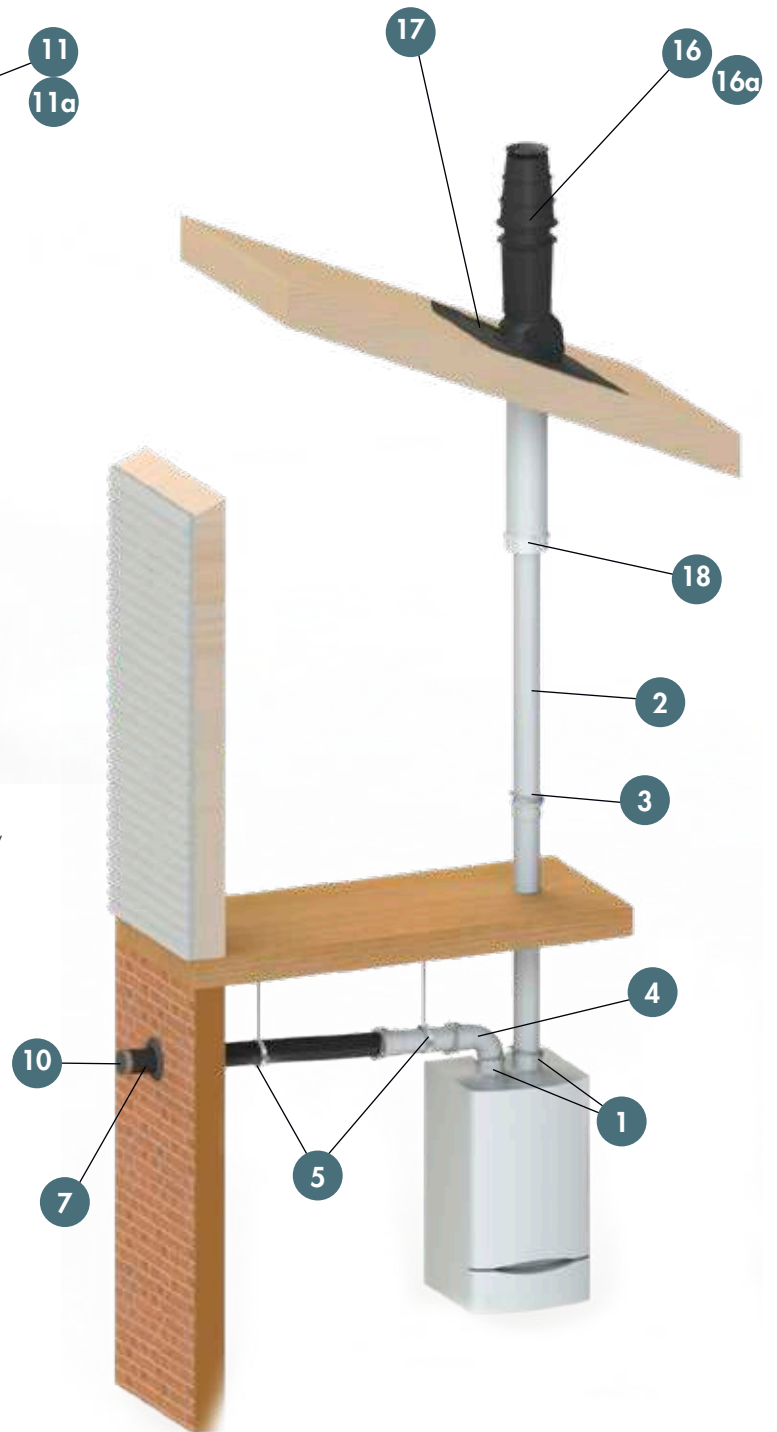

Vertical Vent and Horizontal Air with Vertical Termination

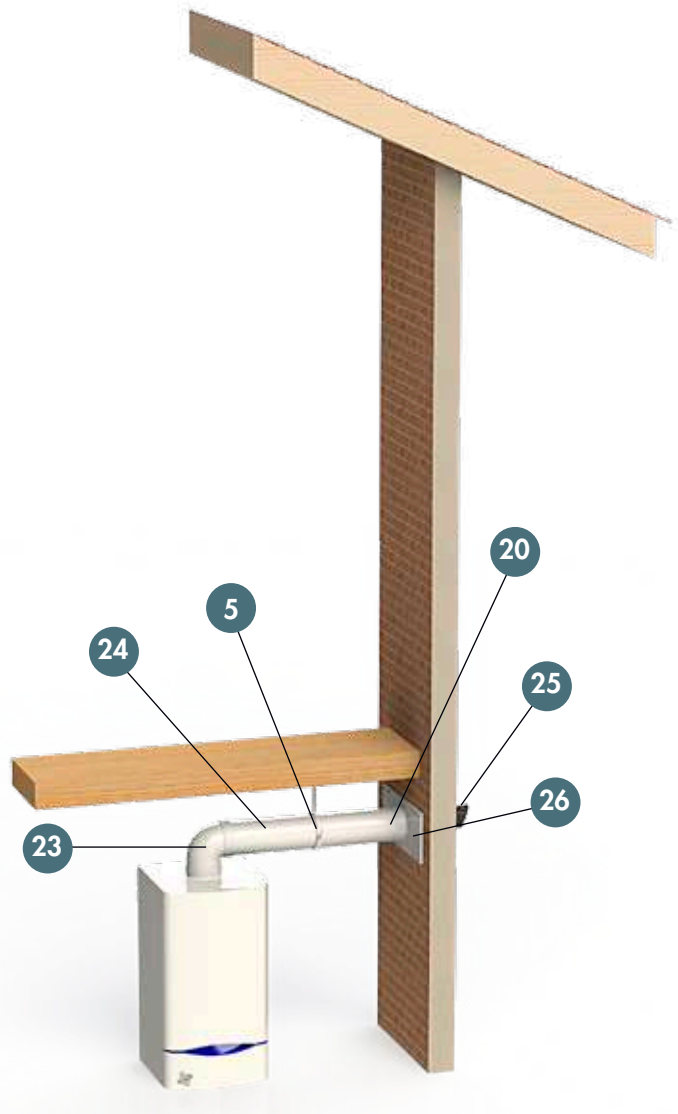

Concentric Horizontal

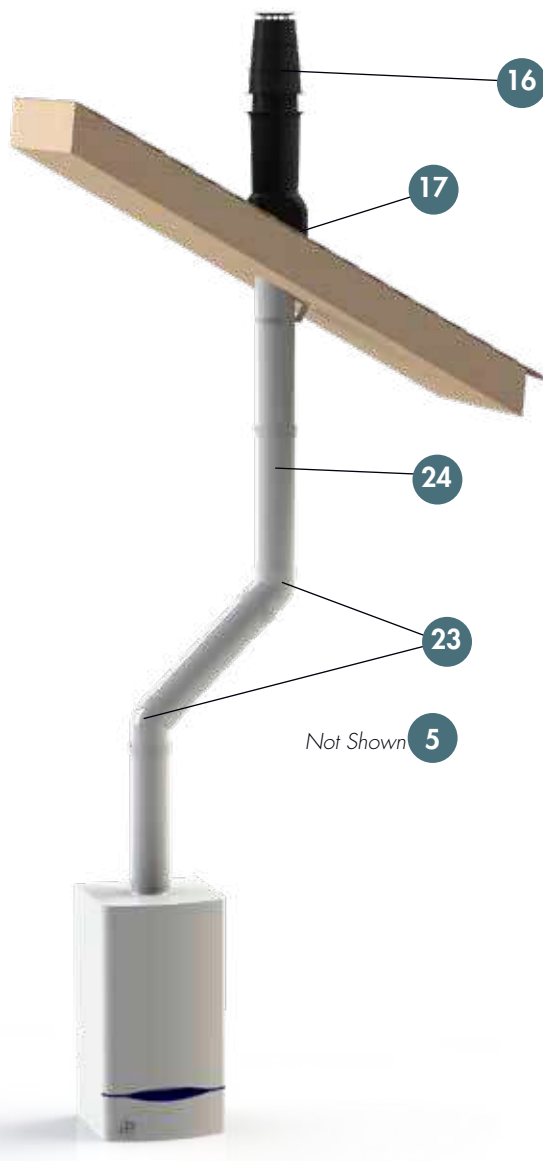

Concentric Vertical

# Z-DENS Direct Vent Applications\*

Item #	Part ID	Description
	2ZDCPVC(2,3,4,6,8)	Adaptor CPVC/PVC Coupling
	2ZDCPVCF(3,4,6)	Adaptor CPVC/PVC Pipe
	2ZDCPVCG(2,3,4,6,8)	Adaptor - Appliance with Gasket & Clamp CPVC/PVC
	2ZDCPVCG3L	Adaptor - Appliance with Gasket & Clamp CPVC/PVC - US Boiler Alpine Wall Mount
	2ZDIBC4	Adaptor IBC SL 4"
<b>1</b>	2ZDCPVCS(3,4)	Adaptor - Appliance with Seal CPVC/PVC - Bosch Greenstar
	2ZDZV(3,4,6,8)	Adaptor Z-Vent to Z-DENS
	2ZD2ZV(3,4,6,8)	Adaptor Z-DENS to Z-Vent
	2ZDTA(42,43,4)	Adaptor Takagi TH3-DV/140-540
	2ZDLAMT0(6,8)	Adaptor Laars MagnaTherm MGTH/V
	2ZDAEDR(6,8)	Adaptor Fulton Endura
	2DAABM(06,08)	Adaptor Aerco Benchmark
	2ZDWASF10(06,08)	Adaptor Weil McLain Slimfit
	2ZDCDFA(4,6,8)	Adaptor Camus DynaForce
	2ZDARA(6,8)	Adaptor Riello Array
	2ZDAHf(3,4,6,8)	Adaptor Saf-T-Vent
<b>2</b>	2ZDP(2,3,4) (12,24,36,72) or 2ZDP(5,6,8)(24,36,72)	Pipe
	2ZDAP(2,3,4)	Adjustable Pipe
<b>3</b>	2ZDLC(2,3,4,5,6,8)B	Locking Clamp Band - 1/Join Required
<b>4</b>	2ZDE(2,3,5,6,8) (45,87) or 2ZDE4(45,87)UV	Elbow 45° or 87°
<b>5</b>	2ZDFB(2,3,4,5,6,8)	Fixing Bracket/Support Clamp See Note 3
<b>6</b>	2ZDWPB(2,3) or 2ZDWVP(5,6)	Wall Plate
<b>7</b>	2ZDP(2,3)(12,24,36) UV	Pipe UV-Black

Item #	Part ID	Description
<b>8</b>	2ZDTT(2,3,4,5,6,8)	Termination Tee with Screens
<b>9</b>	2ZDE(2,3,4)(45,87)UV	Elbow UV-Black (2" & 3") Grey (4")
<b>10</b>	2ZDES(2,3,4,5,6,8)	End Screen
<b>11</b>	2ZDFK(2,3,4)(25,35)	Flexible Kit - Chimney - 25' or 35' (Includes Items <b>12 13 14 15</b> )
<b>11a</b>	2ZDFKX(2,3,4)	Flexible Kit Extension - 10' (Includes Items <b>13 14</b> & Flexible Coupling 2ZDFC(2,3,4))
<b>12</b>	2ZDFBK(2,3,4)	Flexible Base Kit
<b>13</b>	2ZDFL(41,82)(2,3) or 2ZDFL(494,824)	Flexible Liner (41' or 49' or 82')
<b>14</b>	2ZDFS(2,3,4)	Flexible Spacer /Bracing Bracket (2 pieces)
<b>15</b>	2ZD2FLK(2,3,4)	Flexible Liner Kit (Includes Item <b>14</b> (5 pieces) & Chimney Cap with Flexible Connection)
<b>16</b>	2ZDCTV(24,35,46)	Concentric Termination Vertical
<b>16a</b>	2ZDRT(5,6,8)	Roof Termination
	2ZDAF(2,4)	Adjustable Flashing 5°-25°
<b>17</b>	2ZDAFM(2,4,8)	Adjustable Flashing 25°-45°
	2ZDFF(2,4,5,8)	Flat Flashing
<b>18</b>	2ZDCTAC(4,5,6)	Concentric Termination Air Cap
<b>19</b>	2ZDHK(2,3,4)	Horizontal Kit [Includes Items <b>1 2ZDCPVC(2,3,4), 3 20 21</b> ; 2/ea of Items <b>1 3</b> ]
<b>20</b>	2ZDCTH(24,35,46)	Concentric Termination Horizontal
<b>21</b>	2ZDACLC(2224, 3335,4446)	Adaptor Collinear to Concentric
<b>22</b>	2ZDVK(2,3,4)	Vertical Kit [Includes Items <b>1 2ZDCPVC(2,3,4), 3 16 21</b> ; 2/ea of Items <b>1 3</b> ]
<b>23</b>	2ZDCE(24,35,46) (45,87)	Concentric Elbow 45° or 87°
<b>24</b>	2ZDCP(24,35,46) (12,24,36)	Concentric Pipe
	2ZDCAP(24,35,46)	Concentric Adjustable Pipe
<b>25</b>	2ZDTG(4,5,6)	Termination Guard
<b>26</b>	2ZDWPT(24,35,46) or 2ZDWVP(4,5,6)	Wall Plate
<b>27</b>	2ZDGL	Gasket Lubricant - See Note 4

## Notes:

1. Z-DENS is Intertek listed to ULC S636 for zero clearance to combustibles and maximum flue gas temperature of 230°F.
2. Z-DENS conforms to UL1738.
3. Support Z-DENS at: appliance adaptor, elbows, vertically every 78" & horizontally every: 39" (3" to 8") & 19" (2") along the length.

4. Use only Z-DENS Gasket Lubricant: 2ZDGL to ease assembly of joints, apply sparingly on leading edge of gasket.
5. Z-DENS is recyclable and environmentally friendly.
6. Z-DENS is warranted as a vent system unlike most PVC & CPVC.

\*Consult appliance manufacturer's instructions for approved vent applications



# Z-DENS Single Wall

Z-DENS is certified for use with condensing gas and oil fired heating appliances having flue gas temperatures up to 230°F (110°C).

## Specifications

- Specially developed, fire retardant polypropylene
- ULC S636 certified for flue temperatures up to 230°F (110°C)
- Resistant up to a max flue temperature of 248°F (120°C)
- Cat II, IV Special Gas Vent
- Gas Vent BH, Class IIc
- Suitable for use with negative and positive pressure appliances
- Pressure tested to 20 inches W.C. (5000 pa, level H1)
- Available in appliance white finish in diameters 2" and 3"\*  
\*UV stabilized parts available
- Available in UV stabilized grey finish in diameters 4", 5", 6" and 8"

## Significant Advantages

- Vent system made from fire retardant polypropylene
- Long lasting and easy to install as no cure time is required
- Greater resistance to acidic flue gas condensate
- No leaching of chloride, as found in PVC and CPVC reducing boiler contaminates
- No primer or glue containing VOC's
- Environmentally friendly
- Recyclable and LEED compliant
- Non-toxic smoke or fumes if burned, compared to PVC and CPVC

## Safety

All polypropylene material expands and contracts with temperature change. To ensure that the installation initially is and remains completely flue gas tight, it is necessary that the Z-DENS locking clamps and brackets are used. For the correct installation of the locking clamp and bracket, follow the instructions in the installation manual (download at [www.z-flex.com](http://www.z-flex.com)). Only by following these instructions can Z-DENS guarantee a safe and flue gas tight installation. Use only Z-DENS lubricant when installing Z-DENS polypropylene to ensure a quick, reliable and safe connection.

## Environment

During the production of polypropylene flue gas systems less CO<sub>2</sub> is produced than with the production of traditional metal flue gas systems.

## Design Considerations

Greater system efficiencies and a more aesthetically pleasing installation can also be achieved by using Z-DENS Concentric.

# Specification

## Approved polypropylene vent manufacturers

Supplier	Model
Z-Flex U.S. Inc. 20 Commerce Park N, Bedford, NH, 03110 Ph. 800-654-5600	Z-DENS Single Wall, Flexible, Concentric



# Z-DENS Flexible

The flexible polypropylene vent system is specifically designed for connection to condensing gas or oil fired heating appliances with a maximum flue temperature of 230°F (110°C)

## Specifications:

- Made from fire retardant polypropylene
- Resistant up to max flue temperature of 248°F (120° C)
- Operates in negative and positive pressure modes
- Pressure tested to 20" WC (5000 pa, level H1)
- Chimney termination is UV resistant, flexible is not UV resistant
- Designed as a vertical flue system installation but is safe to run at angles up to 45° from vertical
- Available in white

## Simple installation is ensured because:

- Flexible pipe can be cut to length on site
- Coupling connectors allow easy joining of shorter lengths which can virtually eliminate waste
- Lightweight flue system for ease of installation
- Compact packaging due to its great flexibility
- Wide range of accessories

## Installation

The installation manual of Z-DENS Flexible shows just how simple it is to assemble and install the flexible vent system.

Z-DENS Flexible installation instructions and [video are available](#) in the download section of our website at [www.z-flex.com](http://www.z-flex.com).

**This flexible flue system is available in 3 diameters:**

Nominal Diameter    2" (60 mm)    3" (80 mm)    4" (110 mm)

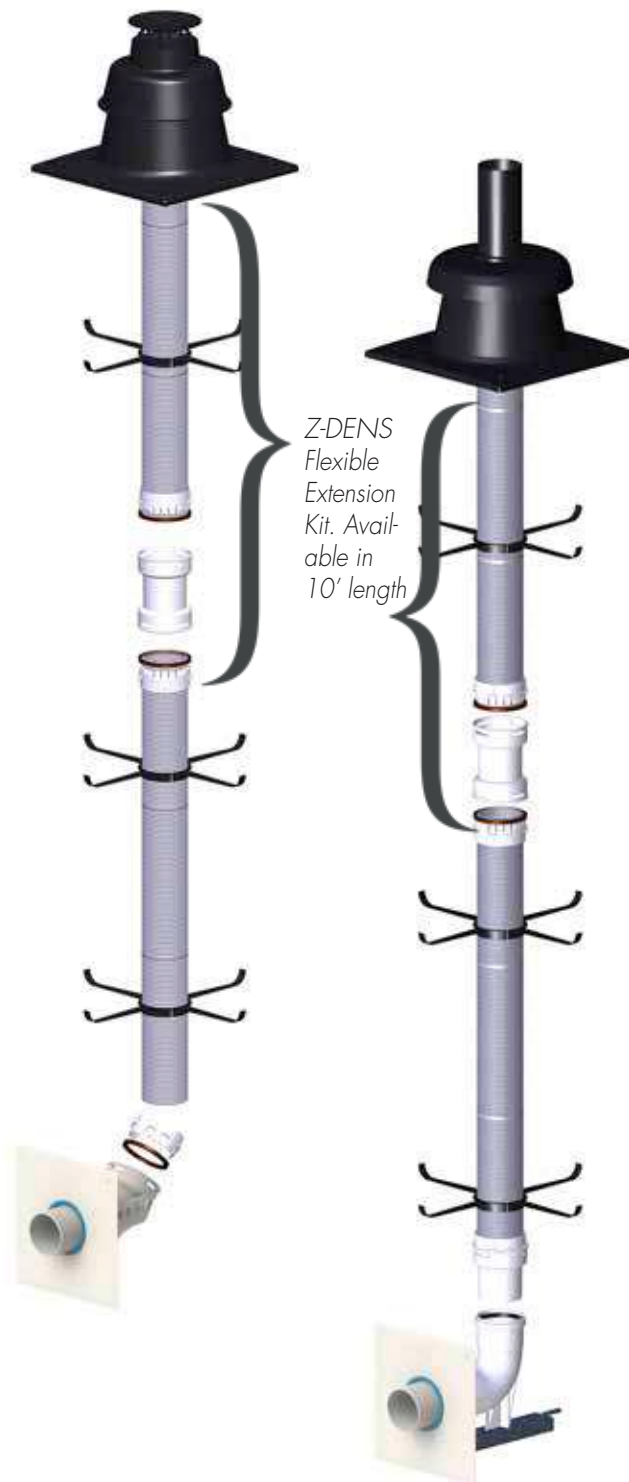

Z-DENS Flexible Extension Kit. Available in 10' length

2" (60 mm)  
3" (80 mm)

4" (110 mm)

## Z-DENS Flexible Chimney Kits

- Kits are available in 25' & 35' lengths and 10' extension



## Z-DENS Concentric

Z-DENS CONCENTRIC is precisely designed for use with condensing gas and oil heating appliances.

Certified to ULC S636 and CE Marked to European standards EN 1856-1 and EN 14471.

Z-DENS CONCENTRIC, through continuous improvement, is engineered for optimum performance.

The outer pipe is aluminum and the inner flue pipe is manufactured with fire retardant polypropylene.

*(Please Note: Z-DENS CONCENTRIC can only be selected for use with high efficiency/condensing appliances.)*

The inner pipe is centered in the outer pipe by the patented connection (Patent number: NL C 1022411). This system is available in concentric diameter sizes 2"/4" (60/100 mm), 3"/5" (80/125 mm) and 4"/6" (110/160 mm). Colour of outer pipe is white (RAL9016).

### Significant Advantages

- The system is easy to assemble
- The system is particularly rigid
- It is modern in appearance
- The same system can be used indoors as well as outdoors
- Patent number: NL C 1022411
- Certified to ULC S636 Gas Vent-BH Class II C - 110°C/ 230°F
- CE Marked according the European standards EN 1856-1 and EN 14471



### Z-DENS CONCENTRIC The Next Generation in Flue Systems

2"/4" | 3"/5" | 4"/6" (60/100 | 80/125 | 110/160 mm)

Z-DENS CONCENTRIC designed for use with condensing heating appliances. The system has an inner polypropylene flue outlet pipe which is centered in the outer aluminum air intake pipe by the patented CONNEX<sub>T</sub><sup>®</sup>-connection. The system is available in the nominal concentric measurements 2"/4", 3"/5" and 4"/6" (60/100, 80/125 and 110/160 mm), in the colour white (RAL 9016).

## Vertical

## Vertical Kit



## Horizontal



## Horizontal Kit



## Additional Terminations



# Z-DENS Concentric Terminations

Z-DENS CONCENTRIC TERMINATIONS are suitable for any condensing appliance.

Designed with exceptional features including; modern appearance, outstanding aerodynamics, rain water management, cleaning and concentric or collinear (horizontal & vertical kit) options.

### Vertical Design Features:

- Upper roof part is made of black RAL9005; UV resistant polypropylene for 2"/4" (60/100 mm) and 3"/5" (80/125 mm) or aluminum cap and galvanized outer air intake pipe for 4"/6" (110/160 mm)
- Outer air intake pipe below roof is made of white RAL 9016 galvanized steel
- Flue pipe is made of fire retardant polypropylene
- **Icicle-Free** - The cap allows some rain water to enter vent reducing icicle formation and aids in diluting PH of condensate
- **Aerodynamics** - Outstanding aerodynamic behaviour, with very low influence of wind

### Horizontal Design Features:

- Outer wall part is made of grey RAL7001 UV resistant polypropylene for 2"/4" (60/100 mm) and 3"/5" (80/125 mm) or white RAL 9016 aluminum end and galvanized outer air intake pipe for 4"/6" (110/160 mm)
- Flue pipe is made of fire retardant polypropylene
- **Nozzle/Water Outlet** - The specially designed nozzle end prevents ingress of rain water. A collector with drip edge makes sure rain water and condensation are drained directly to the ground and not down the wall.
- **Aerodynamics** - Outstanding aerodynamic behaviour, with very low influence of wind
- **Removing/Cleaning** - The removal to clean nozzle end is simple, only a screw driver is needed

### Z-DENS ADDITIONAL TERMINATIONS











- Z-DENS has additional UV resistant polypropylene terminations including; pipes, 45° and 90° elbows all for use with stainless steel end screens.
- Z-DENS has additional stainless steel terminations including: tees with built in screens and horizontal low profile kits.

# Z-DENS 2" Single Wall Rigid

Polypropylene Vent System for High Efficiency Condensing Appliances

Image	Part ID	Description
	2ZDCPVC2	Z-DENS Adaptor 2" CPVC/PVC Coupling to 2" (60 mm) Z-DENS L = 4" L <sub>E</sub> = 2.5" - Stainless Steel
	2ZDCPVCG2	Z-DENS Adaptor - Appliance with Gasket & Clamp - 2" CPVC/PVC to 2" (60 mm) Z-DENS L = 4" L <sub>E</sub> = 2.5" - Stainless Steel
	2ZDTA42	Z-DENS Adaptor - Takagi T-H3-DV/140-540 to 2" (60 mm) Z-DENS L <sub>E</sub> = 7.7" - Stainless Steel
	2ZDP212	Z-DENS Pipe 2" (60 mm) L = 12" L <sub>E</sub> = 10.2" White
	2ZDP212UV	Z-DENS Pipe 2" (60 mm) L = 12" L <sub>E</sub> = 10.2" UV-Black
	2ZDP224	Z-DENS Pipe 2" (60 mm) L = 24" L <sub>E</sub> = 22.2" White
	2ZDP224UV	Z-DENS Pipe 2" (60 mm) L = 24" L <sub>E</sub> = 22.2" UV-Black
	2ZDP236	Z-DENS Pipe 2" (60 mm) L = 36" L <sub>E</sub> = 34.2" White
	2ZDP236UV	Z-DENS Pipe 2" (60 mm) L = 36" L <sub>E</sub> = 34.2" UV-Black
	2ZDP272	Z-DENS Pipe 2" (60 mm) L = 72" L <sub>E</sub> = 70.2" White
		2ZDAP2
	2ZDTP2	Z-DENS Test Port 2" (60 mm) L = 7" L <sub>E</sub> = 5.1" White
	2ZDTP2G	Z-DENS Test Port or Temperature Gauge with 1/8" - 27 NPT Threads 2" (60 mm) L = 9.8" L <sub>E</sub> = 8.0" White
	2ZDE245	Z-DENS Elbow 2" (60 mm) 45° L <sub>1</sub> = 2.8" L <sub>3</sub> = 3.2" L <sub>3E</sub> = 1.4" White
	2ZDE245UV	Z-DENS Elbow 2" (60 mm) 45° L <sub>1</sub> = 2.8" L <sub>3</sub> = 3.2" L <sub>3E</sub> = 1.4" UV-Black
	2ZDE287	Z-DENS Elbow 2" (60 mm) 87° L <sub>1</sub> = 4.3" L <sub>3</sub> = 4.7" L <sub>3E</sub> = 3.0" White
	2ZDE287UV	Z-DENS Elbow 2" (60 mm) 87° L <sub>1</sub> = 4.3" L <sub>3</sub> = 4.7" L <sub>3E</sub> = 3.0" UV-Black

Product Catalogue & Dimensional Data  
**Z-DENS 2" Single Wall Rigid**  
 Polypropylene Vent System for High Efficiency Condensing Appliances

Image	Part ID	Description
	2ZDCD2	Z-DENS Condensate Drain 2" (60 mm) L = 5.9" L <sub>E</sub> = 4.1" Drain O.D. = 0.79" Horizontal/Vertical White
	2ZDCT	Z-DENS Condensate Trap [Trap with 1.26" Inlet & 0.98" Outlet, 0.98" x 40" L Outlet Hose & <b>For 2" to 4" Diameters</b> (1.26 x 0.79" Reducer & <b>For Condensate Drains Installed Vertically:</b> 0.79" x Barb Fitting, 0.75" x 40" L Inlet Hose & Hose Clamp for Condensate Drain Connection)] H = 9.5"
	2ZDI23	Z-DENS Increaser 2" to 3" (60 to 80 mm) L = 5.3" L <sub>E</sub> = 3.5" Eccentric - White
	2ZDR32	Z-DENS Reducer 3" to 2" (80 to 60 mm) L = 5.3" L <sub>E</sub> = 3.5" Concentric - White
	2SVSLSF02	Z-DENS Storm Collar 2" (60 mm) W = 6" - Stainless Steel
	2SVSADJF02	Z-DENS Adjustable Flashing 2" (60 mm) 0° - 30° H = 5" W = 14" x 14" - Stainless Steel
	2ZDTT2	Z-DENS Termination Tee with Screen 2" (60 mm) - Stainless Steel
	2ZDES2	Z-DENS End Screen 2" (60 mm) - Stainless Steel
	2ZDES2V	Z-DENS End Screen 2" (60 mm) VERTICAL - Stainless Steel. For use with 2ZDCC2
	2ZDCC2	Z-DENS Chimney Cover (RIGID) 2" (60 mm) H = 10.7" W = 13.7" x 13.7" UV-Black

# Z-DENS 2" Single Wall Rigid

Polypropylene Vent System for High Efficiency Condensing Appliances

Image	Part ID	Description
	2ZDRS2	Z-DENS Rigid Spacer 2" (60 mm) W = 15.7" (2 pieces) 1 Every 78" Centers Pipe in Chimney/Chase/B-Vent
	2ZDRBK2	Z-DENS Rigid Base Kit 2" (60 mm) L <sub>1</sub> = 4.3" L <sub>3</sub> = 4.7" L <sub>3E</sub> = 3" H = 9.8" W = 9.8" Bracket = 15.4"
	2ZDHKLP2	Z-DENS Horizontal Kit Low Profile for 2" (60 mm) Z-DENS L = 12" L <sub>E</sub> = 10.2" H = 7.5" W = 10.5" - Stainless Steel
	2ZDHKLP2A	Z-DENS Horizontal Kit Low Profile Adaptor - 2" CPVC/PVC (Iplex System 636) to 2" (60 mm) Z-DENS Vent & 2" CPVC/PVC Air L = 12" L <sub>E</sub> = 10.2" - Stainless Steel
	2ZDHVK2	Z-DENS Horizontal Vent Kit 2" (60 mm) (End Screen, UV Pipe 24" Long, Elbow 87°, Pipe 36" Long, 2 Locking Clamps & 2 Wall Plates)
	2ZDHK2	Z-DENS Horizontal Kit 2" (60 mm) (Concentric Termination Horizontal, Adaptor Collinear to Concentric, 2 locking clamps & 2 Adaptors CPVC/PVC Coupling to PP)
	2ZDCTH24	Z-DENS Concentric Termination Horizontal 2"/4" (60/100 mm) L = 31.5"
	2ZDVK2	Z-DENS Vertical Kit 2" (60 mm) (Concentric Termination Vertical, Adaptor Collinear to Concentric, 2 locking clamps & 2 Adaptors CPVC/PVC Coupling to PP)
	2ZDCTV24	Z-DENS Concentric Termination Vertical 2"/4" (60/100 mm) H <sub>1</sub> = 21.4" H <sub>2</sub> = 45.3"

Product Catalogue & Dimensional Data  
**Z-DENS 2" Single Wall Rigid**  
 Polypropylene Vent System for High Efficiency Condensing Appliances

Image	Part ID	Description
E = 3.9" Centerline = 4.7""/>	2ZDACLC2224	Z-DENS Adaptor Collinear to Concentric 2" - 2" to 2" / 4" (60 mm to 60/100 mm) L = 5.9" L <sub>E</sub> = 3.9" Centerline = 4.7"
	2ZDCTAC4	Z-DENS Concentric Termination Air Cap 4" (100 mm)
	2ZDFF2	Z-DENS Flat Flashing 2" / 4" (60/100 mm) or 3" / 5" (80/125 mm) 0° H = 3.9" W = 16.1"
	2ZDAF2	Z-DENS Adjustable Flashing (Small) 2" / 4" (60/100 mm) or 3" / 5" (80/125 mm) 5° - 25° W = 19.3" x 19.3"
	2ZDAFM2	Z-DENS Adjustable Flashing Medium 2" / 4" (60/100 mm) or 3" / 5" (80/125 mm) 25° - 45° W = 19.7" x 19.7"
	2SVSGB02	Z-DENS Guy Band 2" (60 mm) - Stainless Steel
	2ZDLC2	Z-DENS Locking Clamp (Accepts Threaded Rod or Lag Stud) 2" (60 mm)
	2ZDLC2B	Z-DENS Locking Clamp Band 2" (60 mm) 1/Joint Required
	2ZDFB2	Z-DENS Fixing Bracket/Support Clamp (Accepts Threaded Rod or Lag Stud) 2" (60 mm)
	2ZDWPT24	Z-DENS Wall Plate Termination SUPPORT 2" / 4" (60/100 mm) H = 6.7" W = 17.1" Aluminum-White
	2ZDWPB2	Z-DENS Wall Plate Black 2" (60 mm) W = 4.2" EPDM
	2ZDGL	Z-DENS Gasket Lubricant

Product Catalogue & Dimensional Data

**Z-DENS 2" Flexible**

Polypropylene Vent System for High Efficiency Condensing Appliances

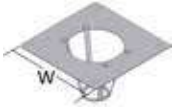





Image	Part ID	Description
	2ZDG2	Z-DENS Gasket 2" (60 mm) - Replacement Rigid or Concentric-Black EPDM
	2ZDG2V	Z-DENS Gasket 2" (60 mm) Replacement Rigid or Concentric Red/Brown FKM (Viton®)
	2ZDFK225	Z-DENS Flexible Kit - Chimney 2" (60 mm) x 25 ft.
	2ZDFK235	Z-DENS Flexible Kit - Chimney 2" (60 mm) x 35 ft.
	2ZDFKX2	Z-DENS Flexible Kit Extension 2" (60 mm) x 10 ft. (Flexible Liner, Flexible Coupling & 2 Flexible Spacers)
	2ZD2FLK2	Z-DENS Flexible Liner Kit 2" (60 mm) (Chimney Cap, Flexible Connection, 5 Flexible Spacers & Hardware) H = 11.3" W = 13.8" x 13.8"
	2ZDFL412	Z-DENS Flexible Liner 2" (60 mm) L = 41 ft.
	2ZDFL822	Z-DENS Flexible Liner 2" (60 mm) L = 82 ft.
	2ZDFS2	Z-DENS Flexible Spacer / Bracing Bracket 2" (60 mm) W = 11.5" (2 pieces) 1 Every 78" Centers Liner in Chimney/Chase/B-Vent
	2ZDFBK2	Z-DENS Flexible Base Kit 2" (60 mm) L <sub>1</sub> = 6.9" L <sub>3</sub> = 2.3" H = 9.8" W = 9.8" (B2)
	2ZDFBK2E	Z-DENS Flexible Base Kit 2" (60 mm) EXTENDABLE L <sub>1</sub> = 4.3" L <sub>3</sub> = 3.9" H = 9.8" W = 9.8" Bracket = 15.4" (B2)
	2ZDFBCL2	Z-DENS Flexible Base to Collinear 2" (60 mm) L <sub>1</sub> = 9.8" L <sub>3</sub> = 1.5" H = 7.1" W = 11.4" - Ventilated Chimney Air (C9)

Product Catalogue & Dimensional Data  
**Z-DENS 2" Flexible**  
 Polypropylene Vent System for High Efficiency Condensing Appliances

Image	Part ID	Description
	2ZDFBC2	Z-DENS Flexible Base to Concentric 2" to 2"/4" (60 to 60/100 mm) L <sub>1</sub> = 8.6" L <sub>3</sub> = 0.5" H = 9.8" W = 9.8" - Room Air (B3)
	2ZDFBC224	Z-DENS Flexible Base to Concentric 2" to 2"/4" (60 to 60/100 mm) L <sub>1</sub> = 8.6" L <sub>3</sub> = 0.5" H = 9.8" W = 9.8" - Ventilated Chimney Air (C9x)
	2ZDFBK2245	Z-DENS Flexible Base Kit 2" (60 mm) Vent - 2" (60 mm) Air 45° L <sub>1</sub> = 8.5" L <sub>3</sub> = 2.2" H = 9.8" W = 13.6" For Use with 2ZDFBKS22
	2ZDFBKS22	Z-DENS Flexible Base Kit SUPPORT (98 ft. MAX.) 2" (60 mm) Vent - 2" (60 mm) Air W = 11.4" x 11.4" W <sub>1</sub> = 13.5" x 13.5" For Use with 2ZD2FLK2
	2ZDFTT2	Z-DENS Flexible Termination Tee/Support (98 ft. MAX.) 2" (60 mm) W = 21.5"
	2ZDRCC2	Z-DENS Round Chimney Cover (FLEXIBLE) 2" (60 mm) to 4" or 5" B-Vent
	2ZD5BV2	Z-DENS Cap 5" B-Vent to 2" (60 mm) Z-DENS
	2ZDCPS2	Z-DENS Flexible Ceiling Plate 2" (60 mm) L = 3.9" L <sub>E</sub> = 2.6" W = 9.8" x 9.8" (B2)
	2ZDCPC2	Z-DENS Flexible Ceiling Plate to Concentric 2" to 2"/4" (60 to 60/100 mm) L = 3.9" L <sub>E</sub> = 2.6" W = 9.8" x 9.8" - Ventilated Chimney Air (C9x)
	2ZDCPCT2	Z-DENS Flexible Ceiling Plate to Concentric Telescopic 2" to 2"/4" (60 to 60/100 mm) L = 11.9" L <sub>E</sub> = 10.6" W = 9.8" x 9.8" - Ventilated Chimney Air (C9x)
	2ZDFC2	Z-DENS Flexible Coupling 2" (60 mm) L = 5.5" L <sub>E</sub> = 2.9"
	2ZDFFA2	Z-DENS (Rigid) Female to Flexible Adaptor 2" (60 mm) L = 4.3" L <sub>E</sub> = 3" For Use with 2ZDFFAS2

## Z-DENS 2" Flexible

Polypropylene Vent System for High Efficiency Condensing Appliances

Image	Part ID	Description
	2ZDFFAS2	Z-DENS Female to Flexible Adaptor SUPPORT (98 ft. MAX.) 2" (60 mm) W = 12.6" x 12.6"
	2ZDFRA2	Z-DENS Flexible to Rigid (Male) Adaptor 2" (60 mm) L = 3.9" L <sub>E</sub> = 2.6"
	2ZDFR2	Z-DENS Flexible Ring (& FKM/Viton® Gasket) 2" (60 mm) Replacement
	2ZDFIT2	Z-DENS Flexible Installation Tool 2" (60 mm)
	2ZDGL	Z-DENS Gasket Lubricant
	2ZDFG2	Z-DENS Flexible Gasket 2" (60 mm) Replacement - Red/Brown FKM (Viton®)

Product Catalogue & Dimensional Data  
**Z-DENS 3" Single Wall Rigid**  
 Polypropylene Vent System for High Efficiency Condensing Appliances

Image	Part ID	Description
	2ZDCPVC3	Z-DENS Adaptor 3" CPVC/PVC Coupling to 3" (80 mm) Z-DENS L = 7.3" L <sub>E</sub> = 6.3" - Stainless Steel
	2ZDCPVCG3	Z-DENS Adaptor - Appliance with Gasket & Clamp 3" CPVC/PVC to 3" (80 mm) Z-DENS L = 7.3" L <sub>E</sub> = 6.3" - Stainless Steel
	2ZDCPVCG3L	Z-DENS Adaptor - Appliance with Gasket & Clamp 3" CPVC/PVC to 3" (80 mm) Z-DENS L = 16.2" L <sub>E</sub> = 15.2" - Stainless Steel
	2ZDCPVCS3	Z-DENS Adaptor - Appliance with Seal 3" CPVC/PVC to 3" (80 mm) Z-DENS L = 7.3" L <sub>E</sub> = 6.3" - Stainless Steel
	2ZDCPVCF3	Z-DENS Adaptor 3" CPVC/PVC Pipe to 3" (80 mm) Z-DENS L = 5.8" L <sub>E</sub> = 2.5" - Stainless Steel
	2ZDTA43	Z-DENS Adaptor Takagi T-H3-DV/140-150 to 3" (80 mm) Z-DENS L = 5.7" L <sub>E</sub> = 4.2" - Stainless Steel
	2ZDZV3	Z-DENS Adaptor 3" Z-Vent to 3" (80 mm) Z-DENS L = 5.8" L <sub>E</sub> = 4.5" - Stainless Steel
	2ZD2ZV3	Z-DENS Adaptor 3" (80 mm) Z-DENS to 3" Z-Vent L = 7.9" L <sub>E</sub> = 6.0" - Stainless Steel
	2ZDAHf3	Z-DENS Adaptor 3" Saf-T-Vent to 3" (80 mm) Z-DENS - Stainless Steel
	2ZDP312	Z-DENS Pipe 3" (80 mm) L = 12" L <sub>E</sub> = 10.2" White
	2ZDP312UV	Z-DENS Pipe 3" (80 mm) L = 12" L <sub>E</sub> = 10.2" UV-Black
	2ZDP324	Z-DENS Pipe 3" (80 mm) L = 24" L <sub>E</sub> = 22.2" White
	2ZDP324UV	Z-DENS Pipe 3" (80 mm) L = 24" L <sub>E</sub> = 22.2" UV-Black
	2ZDP336	Z-DENS Pipe 3" (80 mm) L = 36" L <sub>E</sub> = 34.2" White
	2ZDP336UV	Z-DENS Pipe 3" (80 mm) L = 36" L <sub>E</sub> = 34.2" UV-Black
	2ZDP372	Z-DENS Pipe 3" (80 mm) L = 72" L <sub>E</sub> = 70.2" White
 	2ZDAP3	Z-DENS Adjustable Pipe 3" (80 mm) L = 2.4" to 8.3" White
	2ZDTP3	Z-DENS Test Port 3" (80 mm) L = 10" L <sub>E</sub> = 8.1" White
 	2ZDTP3G	Z-DENS Test Port or Temperature Gauge with 1/8" - 27 NPT Threads 3" (80 mm) L = 9.8" L <sub>E</sub> = 8.0" White

# Z-DENS 3" Single Wall Rigid

Polypropylene Vent System for High Efficiency Condensing Appliances

Image	Part ID	Description
	2ZDE345	Z-DENS Elbow 3" (80 mm) 45° L <sub>1</sub> = 3.5" L <sub>3</sub> = 3.5" L <sub>3E</sub> = 1.8" White
	2ZDE345UV	Z-DENS Elbow 3" (80 mm) 45° L <sub>1</sub> = 3.5" L <sub>3</sub> = 3.5" L <sub>3E</sub> = 1.8" UV-Black
	2ZDE387	Z-DENS Elbow 3" (80 mm) 87° L <sub>1</sub> = 4.7" L <sub>3</sub> = 5.1" L <sub>3E</sub> = 3.4" White
	2ZDE387UV	Z-DENS Elbow 3" (80 mm) 87° L <sub>1</sub> = 4.7" L <sub>3</sub> = 5.1" L <sub>3E</sub> = 3.4" UV-Black
	2ZDCD3	Z-DENS Condensate Drain 3" (80 mm) L = 6.3" L <sub>E</sub> = 4.5" Drain O.D. = 0.79" Horizontal/Vertical White
	2ZDCT	Z-DENS Condensate Trap [Trap with 1.26" Inlet & 0.98" Outlet, 0.98" x 40"L Outlet Hose & <b>For 2" to 4" Diameters</b> (1.26 x 0.79" Reducer & <b>For Condensate Drains Installed Vertically:</b> 0.79" x Barb Fitting, 0.75" x 40"L Inlet Hose & Hose Clamp for Condensate Drain Connection)] H = 9.5"
	2ZDI34	Z-DENS In increaser 3" to 4" (80 to 110 mm) L = 5.5" L <sub>E</sub> = 3.7" Eccentric - White
	2ZDR43	Z-DENS Reducer 4" to 3" (110 to 80 mm) L = 6" L <sub>E</sub> = 4.3" Eccentric
	2SVSLSF03	Z-DENS Storm Collar 3" (80 mm) W = 7" - Stainless Steel
	2SVSSCSF03	Z-DENS Flat Flashing 3" (80 mm) 0° - 5° H = 12" W = 12.5" x 12.5" - Stainless Steel
	2SVSADJF03	Z-DENS Adjustable Flashing 3" (80 mm) 0° - 30° H = 6" W = 16" x 16" - Stainless Steel

Product Catalogue & Dimensional Data  
**Z-DENS 3" Single Wall Rigid**  
 Polypropylene Vent System for High Efficiency Condensing Appliances







Image	Part ID	Description
	2ZDTT3	Z-DENS Termination Tee with Screen 3" (80 mm) - Stainless Steel
	2ZDES3	Z-DENS End Screen 3" (80 mm) Stainless Steel
	2ZDES3V	Z-DENS End Screen 3" (80 mm) VERTICAL - Stainless Steel. For use with 2ZDCC3
	2ZDCC3	Z-DENS Chimney Cover (RIGID) 3" (80 mm) H = 10.7" W = 13.7" x 13.7" UV-Black
	2ZDRS3	Z-DENS Rigid Spacer 3" (80 mm) W = 15.7" (2 pieces) 1 Every 78" Centers Pipe in Chimney/Chase/B-Vent
	2ZDRBK3	Z-DENS Rigid Base Kit 3" (80 mm) L <sub>1</sub> = 4.7" L <sub>3</sub> = 5.1" L <sub>3E</sub> = 3.4" H = 10" W = 9.8" Bracket = 15.4"
	2ZDHKLP3	Z-DENS Horizontal Kit Low Profile for 3" (80 mm) Z-DENS L = 12" L <sub>E</sub> = 10.2" H = 8.5" W = 12.5" - Stainless Steel
	2ZDHKLP3A	Z-DENS Horizontal Kit Low Profile Adaptor - 3" CPVC/PVC (Iplex System 636) to 3" (80 mm) Z-DENS Vent & 3" CPVC/PVC Air L = 12" L <sub>E</sub> = 10.2" - Stainless Steel
	2ZDHVK3	Z-DENS Horizontal Vent Kit 3" (80 mm) (End Screen, UV Pipe 24" Long, Elbow 87°, Pipe 36" Long, 2 Locking Clamps & 2 Wall Plates)
	2ZDHK3	Z-DENS Horizontal Kit 3" (80 mm) (Concentric Termination Horizontal, Adaptor Collinear to Concentric, 2 Locking Clamps & 2 Adaptors CPVC/PVC Coupling to PP)
	2ZDCTH35	Z-DENS Concentric Termination Horizontal 3"/5" (80/125mm) L = 30.9"
	2ZDVK3	Z-DENS Vertical Kit 3" (80 mm) (Concentric Termination Vertical, Adaptor Collinear to Concentric, 2 locking clamps & 2 Adaptors CPVC/PVC Coupling to PP)

# Z-DENS 3" Single Wall Rigid

Polypropylene Vent System for High Efficiency Condensing Appliances

Image	Part ID	Description
" data-bbox="65 155 175 300"/> <p>Diagram showing dimensions H<sub>1</sub> and H<sub>2</sub> for the vertical termination.</p>	2ZDCTV35	Z-DENS Concentric Termination Vertical 3"/5" (80/125 mm) H <sub>1</sub> = 21.7" H <sub>2</sub> = 45.6"
	2ZDACLC3335	Z-DENS Adaptor Collinear to Concentric 3" - 3" to 3"/5" (80 mm to 80/125 mm) L = 6.9" L <sub>E</sub> = 4.9" Centerline = 4.7"
" data-bbox="85 365 170 420"/>	2ZDACCL3533	Z-DENS Adaptor Concentric to Collinear 3"/5" to 3" - 3" (80/125 mm to 80 mm) L = 6.9" L <sub>E</sub> = 5.1" Centerline = 4.7"
 <p>Unique Item</p>	2ZDCTAC5	Z-DENS Concentric Termination Air Cap 5" (125 mm)
" data-bbox="60 510 185 555"/>	2ZDFF2	Z-DENS Flat Flashing 2"/4" (60/100 mm) or 3"/5" (80/125 mm) 0° H = 3.9" W = 16.1"
" data-bbox="85 570 175 630"/> <p>W</p>	2ZDAF2	Z-DENS Adjustable Flashing (Small) 2"/4" (60/100 mm) or 3"/5" (80/125 mm) 5° - 25° W = 19.3" x 19.3"
" data-bbox="85 640 175 700"/> <p>W</p>	2ZDAFM2	Z-DENS Adjustable Flashing Medium 2"/4" (60/100 mm) or 3"/5" (80/125 mm) 25° - 45° W = 19.7" x 19.7"
 <p>Unique Item</p>	2SVSGB03	Z-DENS Guy Band 3" (80 mm) - Stainless Steel
 <p>Unique Item</p>	2ZDLC3	Z-DENS Locking Clamp (Accepts Threaded Rod or Lag Stud) 3" (80 mm)
 <p>Unique Item</p>	2ZDLC3B	Z-DENS Locking Clamp Band 3" (80 mm) 1/Joint Required

Product Catalogue & Dimensional Data  
**Z-DENS 3" Single Wall Rigid**  
 Polypropylene Vent System for High Efficiency Condensing Appliances

Image	Part ID	Description
	2ZDFB3	Z-DENS Fixing Bracket /Support Clamp (Accepts Threaded Rod or Lag Stud) 3" (80 mm)
	2ZDWPT35	Z-DENS Wall Plate Termination SUPPORT 3"/5" (80/125 mm) H = 7.7" W = 17.1" Aluminum-White
	2ZDWPB3	Z-DENS Wall Plate Black 3" (80 mm) W = 5.6" EPDM
	2ZDGL	Z-DENS Gasket Lubricant
	2ZDG3	Z-DENS Gasket 3" (80 mm) Replacement Rigid or Concentric Black EPDM
	2ZDG3V	Z-DENS Gasket 3"(80 mm) Replacement Rigid or Concentric Red/ Brown FKM (Viton®)

## Z-DENS 3" Flexible

Polypropylene Vent System for High Efficiency Condensing Appliances

Image	Part ID	Description
	2ZDFK325	Z-DENS Flexible Kit - Chimney 3" (80 mm) x 25 ft.
	2ZDFK335	Z-DENS Flexible Kit - Chimney 3" (80 mm) x 35 ft.
	2ZDFKX3	Z-DENS Flexible Kit Extension 3" (80 mm) x 10 ft. (Flexible Liner, Flexible Coupling & Flexible Spacers)
	2ZD2FLK3	Z-DENS Flexible Liner Kit 3" (80 mm) (Chimney Cap, Flexible Connection, 5 Flexible Spacers & Hardware) H = 11.3" W = 13.8" x 13.8"
	2ZDFL413	Z-DENS Flexible Liner 3" (80 mm) L = 41 ft.
	2ZDFL823	Z-DENS Flexible Liner 3" (80 mm) L = 82 ft.
	2ZDFS3	Z-DENS Flexible Spacer / Bracing Bracket 3" (80 mm) W = 15.7" (2 pieces) 1 Every 78" Centers Liner in Chimney/Chase/B-Vent
	2ZDFBK3	Z-DENS Flexible Base Kit 3" (80 mm) L <sub>1</sub> = 7.3" L <sub>3</sub> = 0.5" H = 9.8" W = 9.8" (B2)
	2ZDFBK3E	Z-DENS Flexible Base Kit 3" (80 mm) EXTENDABLE L <sub>1</sub> = 4.7" L <sub>3</sub> = 4.6" H = 9.8" W = 9.8" Bracket = 15.4" (B2)

Product Catalogue & Dimensional Data  
**Z-DENS 3" Flexible**  
 Polypropylene Vent System for High Efficiency Condensing Appliances

Image	Part ID	Description
	2ZDFBCL3	Z-DENS Flexible Base to Collinear 3" (80 mm) $L_1 = 9.5"$ $L_3 = 0.8"$ H = 7.1" W = 11.4" - Ventilated Chimney Air (C9)
	2ZDFBC3	Z-DENS Flexible Base to Concentric 3" to 3"/5" (80 to 80/125 mm) $L_1 = 9.5"$ $L_3 = 0.5"$ H = 9.8" W = 9.8" - Room Air (B3)
	2ZDFBC335	Z-DENS Flexible Base to Concentric 3" to 3"/5" (80 to 80/125 mm) $L_1 = 7.3"$ $L_3 = 0.5"$ H = 9.8" W = 9.8" - Ventilated Chimney Air (C9x)
	2ZDFBK3345	Z-DENS Flexible Base Kit 3" (80 mm) Vent - 3" (80 mm) Air 45° $L_1 = 9.1"$ $L_3 = 2.9"$ H = 9.8" W = 13.6" For Use with 2ZDFBKS33
	2ZDFBKS33	Z-DENS Flexible Base Kit SUPPORT (98 ft. MAX.) 3" (80 mm) Vent - 8" (80 mm) Air W = 11.4" x 11.4" W1 = 13.5" x 13.5" For Use with 2ZD2FLK3
	2ZDFTT3	Z-DENS Flexible Termination Tee/Support (98 ft. MAX.) 3" (80 mm) W = 21.5"
	2ZDRCC3	Z-DENS Round Chimney Cover (FLEXIBLE) 3" (80 mm) to 5" or 6" B-Vent
	2ZD6BV3	Z-DENS Cap 6" B-Vent to 3" (80 mm) Z-DENS
	2ZDCPS3	Z-DENS Flexible Ceiling Plate 3" (80 mm) L = 6" $L_E = 4.7"$ W = 9.8" x 9.8" (B2)
	2ZDCPC3	Z-DENS Flexible Ceiling Plate to Concentric 3" to 3"/5" (80 to 80/125 mm) L = 6" $L_E = 4.7"$ W = 9.8" x 9.8" - Ventilated Chimney Air (C9x)

## Z-DENS 3" Flexible

Polypropylene Vent System for High Efficiency Condensing Appliances







Image	Part ID	Description
	2ZDCPCT3	Z-DENS Flexible Ceiling Plate to Concentric Telescopic 3" to 3"/5" (80 to 80/125 mm) L = 14.1" L <sub>E</sub> = 12.8" W = 9.8" x 9.8" - Ventilated Chimney Air (C9x)
	2ZDFC3	Z-DENS Flexible Coupling 3" (80 mm) L = 5.5" L <sub>E</sub> = 2.8"
	2ZDFFA3	Z-DENS (Rigid) Female to Flexible Adaptor 3" (80 mm) L = 4.3" L <sub>E</sub> = 3" For Use with 2ZDFFAS3
	2ZDFFAS3	Z-DENS Female to Flexible Adaptor SUPPORT (98 ft. MAX.) 3" (80 mm) W = 12.6" x 12.6"
	2ZDFRA3	Z-DENS Flexible to Rigid (Male) Adaptor 3" (80 mm) L = 3.9" L <sub>E</sub> = 2.6"
	2ZDFR3	Z-DENS Flexible Ring (& FKM/Viton® Gasket) 3" (80 mm) Replacement
	2ZDFIT3	Z-DENS Flexible Installation Tool 3" (80 mm)
	2ZDGL	Z-DENS Gasket Lubricant
	2ZDFG3	Z-DENS Flexible Gasket 3" (80 mm) Replacement - Red/Brown FKM (Viton®)

Product Catalogue & Dimensional Data  
**Z-DENS 4" Single Wall Rigid**  
 Polypropylene Vent System for High Efficiency Condensing Appliances

Image	Part ID	Description
	2ZDCPVC4	Z-DENS Adaptor 4" CPVC/PVC Coupling to 4" (110 mm) Z-DENS L = 7.3" L <sub>E</sub> = 6" - Stainless Steel
	2ZDCPVCG4	Z-DENS Adaptor Appliance with Gasket & Clamp - 4" CPVC/ PVC to 4" (110 mm) Z-DENS L = 7.3" L <sub>E</sub> = 6" - Stainless Steel
	2ZDIBC4	Z-DENS Adapter IBC SL 4" to 4" (110 mm) Z-DENS L = 6.5" L <sub>E</sub> = 3.7" - Stainless Steel
	2ZDCPVCS4	Z-DENS Adaptor - Appliance with Seal 4" CPVC/PVC to 4" (110 mm) Z-DENS L = 7.3" L <sub>E</sub> = 6" - Stainless Steel
	2ZDCPVCF4	Z-DENS Adaptor 4" CPVC/PVC Pipe to 4" (110 mm) Z-DENS L = 6.8" L <sub>E</sub> = 3.3" - Stainless Steel
	2ZDTA4	Z-DENS Adaptor Takagi T-H3-DV/140-540 to 4" (110 mm) Z-DENS L = 6.8" L <sub>E</sub> = 5.3" - Stainless Steel
	2ZDZV4	Z-DENS Adaptor 4" Z-Vent to 4" (110 mm) Z-DENS L = 5" L <sub>E</sub> = 3.6" - Stainless Steel
	2ZD2ZV4	Z-DENS Adaptor 4" (110 mm) Z-DENS to 4" Z-Vent L = 7.9" L <sub>E</sub> = 6.0" - Stainless Steel
	2ZDCDFA4	Z-DENS Adaptor - Camus Dyna Force 4" to 4" (110 mm) Z-DENS - Stainless Steel
	2ZDAHf4	Z-DENS Adaptor 4" Saf-T-Vent to 4" (110 mm) Z-DENS - Stainless Steel
	2ZDP412	Z-DENS Pipe 4" (110 mm) L = 12" L <sub>E</sub> = 10" UV-Grey
	2ZDP424	Z-DENS Pipe 4" (110 mm) L = 24" L <sub>E</sub> = 22" UV-Grey
	2ZDP436	Z-DENS Pipe 4" (110 mm) L = 36" L <sub>E</sub> = 34" UV-Grey
	2ZDP472	Z-DENS Pipe 4" (110 mm) L = 72" L <sub>E</sub> = 70" UV-Grey

## Z-DENS 4" Single Wall Rigid

Polypropylene Vent System for High Efficiency Condensing Appliances

Image	Part ID	Description
	2ZDAP4	Z-DENS Adjustable Pipe 4" (110 mm) L = 3.2" to 8.3" - UV-Grey
	2ZDTP4	Z-DENS Test Port 4" (110 mm) L = 8.7" L <sub>E</sub> = 6.7" - UV-Grey
	2ZDTP4G	Z-DENS Test Port or Temperature Gauge with 1/8" - 27 NPT Threads 4" (110 mm) L = 12.6" L <sub>E</sub> = 10.6" UV-Grey
	2ZDE445UV	Z-DENS Elbow 4" (110 mm) 45° L <sub>1</sub> = 3.3" L <sub>3</sub> = 3.5" L <sub>3E</sub> = 1.5" UV-Grey
	2ZDE487UV	Z-DENS Elbow 4" (110 mm) 87° L <sub>1</sub> = 4.3" L <sub>3</sub> = 4.7" L <sub>3E</sub> = 2.7" UV-Grey
	2ZDCD4	Z-DENS Condensate Drain 4" (110 mm) L = 5.9" L <sub>E</sub> = 3.9" Drain O.D. = 0.79" Horizontal/Vertical UV Grey

Product Catalogue & Dimensional Data  
**Z-DENS 4" Single Wall Rigid**  
 Polypropylene Vent System for High Efficiency Condensing Appliances

Image	Part ID	Description
	2ZDCT	Z-DENS Condensate Trap [Trap with 1.26" Inlet & 0.98" Outlet, 0.98" x 40"L Outlet Hose & <b>For 2" to 4" Diameters</b> (1.26 x 0.79" <b>Reducer &amp; For Condensate Drains Installed Vertically:</b> 0.79" x Barb Fitting, 0.75" x 40"L Inlet Hose & Hose Clamp for Condensate Drain Connection)] H = 9.5"
	2ZDI44	Z-DENS Increaser 4" (100 to 110 mm) L = 6.3" L <sub>E</sub> = 4.3" Concentric
	2ZDI46	Z-DENS Increaser 4" to 6" (110 to 160 mm) L = 12.5" L <sub>E</sub> = 10.6" Concentric - Stainless Steel
	2ZDI46E	Z-DENS Increaser 4" to 6" (110 to 160 mm) L = 12.5" L <sub>E</sub> = 10.6" Eccentric - Stainless Steel
	2SVSLSF04	Z-DENS Storm Collar 4" (110 mm) W = 8" - Stainless Steel
	2SVSSCSF04	Z-DENS Flat Flashing 4" (110 mm) 0° - 5° H = 12" W = 14" x 14" - Stainless Steel
	2SVSADJF04	Z-DENS Adjustable Flashing 4" (110 mm) 0° - 30° H = 6" W = 16" x 16" - Stainless Steel
	2ZDTT4	Z-DENS Termination Tee with screen 4" (110 mm) - Stainless Steel
	2ZDES4	Z-DENS End Screen 4" (110 mm) - Stainless Steel
	2ZDES4V	Z-DENS End Screen 4" (110 mm) or 5" (125 mm) VERTICAL - Stainless Steel. For use with 2ZDCC4 or 2ZDCC5 or 2ZDRT5

# Z-DENS 4" Single Wall Rigid

Polypropylene Vent System for High Efficiency Condensing Appliances

Image	Part ID	Description
	2ZDCC4	Z-DENS Chimney Cover (RIGID) 4" (110 mm) H = 7.7" W = 13.7" x 13.7" UV-Black
	2ZDRS4	Z-DENS Rigid Spacer 4" (110 mm) W = 15.7" (2 pieces) 1 Every 78" Centers Pipe in Chimney/Chase/B-Vent
	2ZDRBK4	Z-DENS Rigid Base Kit 4" (110 mm) L <sub>1</sub> = 4.3" L <sub>3</sub> = 4.7" L <sub>3E</sub> = 2.7" H = 10.2" W = 9.8" Bracket = 15.4"
	2ZDHKLP4	Z-DENS Horizontal Kit Low Profile for 4" (110 mm) Z-DENS L = 12" L <sub>E</sub> = 10" H = 9.5" W = 15.1" - Stainless Steel
	2ZDHLPA4	Z-DENS Horizontal Kit Low Profile Adaptor - 4" CPVC/PVC (Iplex System 636) to 4" (110 mm) Z-DENS Vent & 4" CPVC/PVC Air L = 12" L <sub>E</sub> = 10" - Stainless Steel
	2ZDHVK4	Z-DENS Horizontal Vent Kit 4" (110 mm) (End Screen, Pipe 24" Long, Elbow 87°, Pipe 36" Long & 2 Locking Clamps)
	2ZDHK4	Z-DENS Horizontal Kit 4" (110 mm) (Concentric Termination Horizontal, Adaptor Collinear to Concentric, 2 Locking Clamps & 2 Adaptors CPVC/PVC Coupling to PP)
" (110/160 mm) L = 27". The image shows a horizontal pipe with a termination cap. Dimension L is indicated with an arrow."/>	2ZDCTH46	Z-DENS Concentric Termination Horizontal 4"/>" (110/160 mm) L = 27"

Product Catalogue & Dimensional Data  
**Z-DENS 4" Single Wall Rigid**  
 Polypropylene Vent System for High Efficiency Condensing Appliances

Image	Part ID	Description
-------	---------	-------------



2ZDVK4

Z-DENS Vertical Kit 4" (110 mm) (Concentric Termination Vertical, Adaptor Collinear to Concentric, 2 locking clamps & 2 Adaptors CPVC/PVC Coupling to PP)



2ZDCTV46

Z-DENS Concentric Termination Vertical 4"/6" (110/160 mm)  $H_1 = 30.9"$   
 $H_2 = 47"$



2ZDACLC4446

Z-DENS Adaptor Collinear to Concentric 4" - 4" to 4"/6" (110 mm to 110/160 mm)  $L = 9.8"$   $L_E = 7.8"$  Centerline = 6.5"



2ZDCTAC6

Z-DENS Concentric Termination Air Cap 6" (160 mm)



2ZDFF4

Z-DENS Flat Flashing 4"/6" (110/160 mm) or 6" (160 mm) 0°  
 $H = 5.9"$   $W = 17.7"$



2ZDAF4

Z-DENS Adjustable Flashing (Small) 4"/6" (110/160 mm) or 6" (160 mm) 5° - 25°  $W = 19.7" \times 19.7"$



2ZDAFM4





Z-DENS Adjustable Flashing Medium 4"/6" (110/160 mm) 25° - 45°  
 $W = 23.6" \times 19.7"$

## Z-DENS 4" Single Wall Rigid

Polypropylene Vent System for High Efficiency Condensing Appliances

Image	Part ID	Description
	2SVSGB04	Z-DENS Guy Band 4" (110 mm) - Stainless Steel
	2ZDLC4	Z-DENS Locking Clamp (Accepts Threaded Rod or Lag Stud) 4" (110 mm)
	2ZDLC4B	Z-DENS Locking Clamp Band 4" (110 mm) 1/Joint Required
	2ZDFB4	Z-DENS Fixing Bracket/Support Clamp (Accepts Threaded Rod or Lag Stud) 4" (110 mm)
	2ZDWPT46	Z-DENS Wall Plate Termination SUPPORT 4"/6" (110/160 mm) H = 9.1" W = 17.1" Aluminum-White
	2ZDGL	Z-DENS Gasket Lubricant
	2ZDG4	Z-DENS Gasket 4" (110 mm) Replacement Rigid or Concentric - Black EPDM
	2ZDG4V	Z-DENS Gasket 4" (110 mm) Replacement Rigid or Concentric - Red/Brown FKM (Viton®)

Product Catalogue & Dimensional Data  
**Z-DENS 4" Flexible**  
 Polypropylene Vent System for High Efficiency Condensing Appliances

Image	Part ID	Description
	2ZDFK425	Z-DENS Flexible Kit Chimney 4" (110 mm) x 25 ft. Includes Wall Plate and Flexible Connections
	2ZDFK435	Z-DENS Flexible Kit Chimney 4" (110 mm) x 35 ft. Includes Wall Plate and Flexible Connections
	2ZDFKX4	Z-DENS Flexible Kit Extension 4" (110 mm) x 10 ft. (Flexible Liner, Flexible Coupling & 2 Flexible Spacers)
	2ZD2FLK4	Z-DENS Flexible Liner Kit 4" (110 mm) (Chimney Cap, Flexible Connection, 5 Flexible Spacers & Hardware) H = 8.3" W = 13.8" x 13.8"
	2ZDFL494	Z-DENS Flexible Liner 4" (110 mm) L = 49 ft.
	2ZDFL824	Z-DENS Flexible Liner 4" (110 mm) L = 82 ft.
	2ZDFS4	Z-DENS Flexible Spacer / Bracing Bracket 4" (110 mm) W = 15.7" (2 pieces) 1 Every 78" Centers Liner in Chimney/ Chase/B-Vent
	2ZDFBK4	Z-DENS Flexible Base Kit 4" (110 mm) L <sub>1</sub> = 4.3" L <sub>3</sub> = 6.3" H = 9.8" W = 9.8" Bracket = 15.4" (B2)
	2ZDFBK4E	Z-DENS Flexible Base Kit 4" (110 mm) EXTENDABLE L <sub>1</sub> = 4.3" L <sub>3</sub> = 4.4" H = 9.8" W = 9.8" Bracket = 15.4" (B2)
	2ZDFC4	Z-DENS Flexible Coupling 4" (110 mm) L = 5.5" L <sub>E</sub> = 2.7"

## Z-DENS 4" Flexible

Polypropylene Vent System for High Efficiency Condensing Appliances

Image	Part ID	Description
	2ZDFFA4	Z-DENS (Rigid) Female to Flexible Adaptor 4" (110 mm) L = 4.3" L <sub>E</sub> = 2.9" For Use with 2ZDFFAS4
	2ZDFFAS4	Z-DENS Female to Flexible Adaptor SUPPORT (98 ft. MAX.) 4" (110 mm) W = 12.6" x 12.6"
	2ZDFRA4	Z-DENS Flexible to Rigid (Male) Adaptor 4" (110 mm) L = 3.9" L <sub>E</sub> = 2.5"
	2ZDFR4	Z-DENS Flexible Ring (& FKM/Viton® Gasket) 4" (110 mm) Replacement
	2ZDFIT4	Z-DENS Flexible Installation Tool 4" (110 mm)
	2ZDGL	Z-DENS Gasket Lubricant
	2ZDFG4	Z-DENS Flexible Gasket 4" (110 mm) Replacement - Red/Brown FKM (Viton®)







Product Catalogue & Dimensional Data  
**Z-DENS 5" Single Wall Rigid - SPECIAL ORDER**  
 Polypropylene Vent System for High Efficiency Condensing Appliances

Image	Part ID	Description
	2ZDP524	Z-DENS Pipe 5" (125 mm) L = 24" L <sub>E</sub> = 21.7" UV-Grey
	2ZDP536	Z-DENS Pipe 5" (125 mm) L = 36" L <sub>E</sub> = 33.7" UV-Grey
	2ZDP572	Z-DENS Pipe 5" (125 mm) L = 72" L <sub>E</sub> = 69.7" UV-Grey
	2ZDTP5	Z-DENS Test Port 5" (125 mm) L = 8.7" L <sub>E</sub> = 6.4" UV-Grey
	2ZDTP5G	Z-DENS Test Port or Temperature Gauge with 1/8" - 27 NPT Threads 5" (125 mm) L = 10.8" L <sub>E</sub> = 8.5" UV-Grey
	2ZDE545	Z-DENS Elbow 5" (125 mm) 45° L <sub>1</sub> = 3.9" L <sub>3</sub> = 3.9" L <sub>3E</sub> = 1.4" UV-Grey
	2ZDE587	Z-DENS Elbow 5" (125 mm) 87° L <sub>1</sub> = 5.8" L <sub>3</sub> = 5.7" L <sub>3E</sub> = 3.2" UV-Grey
	2ZDCD5H	Z-DENS Condensate Drain 5" (125 mm) L = 8.7" L <sub>E</sub> = 6.4" Drain O.D. = 1.26" Horizontal UV-Grey
	2ZDCT	Z-DENS Condensate Trap [Trap with 1.26" Inlet & 0.98" Outlet, 0.98" x 40" L Outlet Hose & <b>For 2" to 4" Diameters</b> (1.26 x 0.79" Reducer & <b>For Condensate Drains Installed Vertically:</b> 0.79" x Barb Fitting, 0.75" x 40" L Inlet Hose & Hose Clamp for Condensate Drain Connection)] H = 9.5"

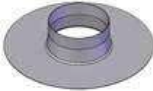
Product Catalogue & Dimensional Data  
**Z-DENS 5" Single Wall Rigid - SPECIAL ORDER**  
 Polypropylene Vent System for High Efficiency Condensing Appliances

Image	Part ID	Description
	2ZDI45	Z-DENS Increaser 4" to 5" (110 to 125 mm) L = 7" L <sub>E</sub> = 4.8" Eccentric
	2ZDI56	Z-DENS Increaser 5" to 6" (125 mm to 160 mm) L = 8.3" L <sub>E</sub> = 5.7" Eccentric
	2ZDR65	Z-DENS Reducer 6" to 5" (160 to 125 mm) L = 7.1" L <sub>E</sub> = 4.8" Eccentric
	2ZDR54	Z-DENS Reducer 5" to 4" (125 to 110 mm) L = 5.5" L <sub>E</sub> = 3.5" Eccentric
	2SVSLS05	Z-DENS Storm Collar 5" (125 mm) W = 9" - Stainless Steel
	2SVSF05	Z-DENS Flat Flashing 5" (125 mm) 0° - 5° H = 12" W = 16" x 16" - Stainless Steel
	2SVSFA05	Z-DENS Adjustable Flashing 5" (125 mm) 0° - 30° H = 6" W = 16" x 16" - Stainless Steel
	2ZDIT5	Z-DENS Termination Tee with Screen 5" (125 mm) - Stainless Steel
	2ZDES5	Z-DENS End Screen 5" (125 mm) - Stainless Steel
	2ZDES4V	Z-DENS End Screen 4" (110 mm) or 5" (125 mm) VERTICAL - Stainless Steel For use with 2ZDCC4 or 2ZDCC5 or 2ZDRT5
	2ZDCC5	Z-DENS Chimney Cover (RIGID) 5" (125 mm) H = 10.3" W = 13.6" x 13.6"
	2ZDRS5	Z-DENS Rigid Spacer 5" (125 mm) W = 15.8" (2 pieces) 1 Every 78" Centers Pipe in Chimney/Chase/B-Vent
	2ZDRBK5	Z-DENS Rigid Base Kit 5" (125 mm) L <sub>1</sub> = 5.8" L <sub>3</sub> = 5.7" L <sub>3E</sub> = 3.2" H = 10.6" W = 9.8" Bracket = 15.4"

Product Catalogue & Dimensional Data  
**Z-DENS 5" Single Wall Rigid - SPECIAL ORDER**  
 Polypropylene Vent System for High Efficiency Condensing Appliances

Image	Part ID	Description
	2ZDRT5	Z-DENS Roof Termination 5" (125 mm) H <sub>1</sub> = 34" H <sub>2</sub> = 59" with Bracket PPs/ Galvanized-Black
	2ZDFF5	Z-DENS Flat Flashing 5" (125 mm) 0° H = 3.9" W = 17.1"
	2SVSGB05	Z-DENS Guy Band 5" (125 mm) - Stainless Steel
	2ZDLC5	Z-DENS Locking Clamp (Accepts Threaded Rod or Lag Stud) 5" (125 mm)
	2ZDLC5B	Z-DENS Locking Clamp Band 5" (125 mm) 1/Joint Required
	2ZDFB5	Z-DENS Fixing Bracket/Support Clamp (Accepts Threaded Rod or Lag Stud) 5" (125 mm)
	2ZDGL	Z-DENS Gasket Lubricant
	2ZDG5	Z-DENS Gasket 5" (125 mm) Replacement Single Wall Rigid - Black EPDM
	2ZDG5V	Z-DENS Gasket 5" (125 mm) Replacement Single Wall Rigid Red/Brown FKM(Viton®)

## Z-DENS 6" Single Wall Rigid

Polypropylene Vent System for High Efficiency Condensing Appliances

Image	Part ID	Description
	2ZDCPVC6	Z-DENS Adaptor 6" CPVC/PVC Coupling to 6" (160 mm) Z-DENS L = 11.2" L <sub>E</sub> = 9.3" - Stainless Steel
	2ZDCPVCG6	Z-DENS Adaptor Appliance with Gasket & Clamp 6" CPVC/PVC to 6" (160 mm) Z-DENS L = 11.2" L <sub>E</sub> = 9.3" - Stainless Steel
	2ZDCPVCF6	Z-DENS Adaptor 6" CPVC/PVC Pipe to 6" (160 mm) Z-DENS L = 12.9" L <sub>E</sub> = 9.5" - Stainless Steel
	2ZDZV6	Z-DENS Adaptor 6" Z-Vent to 6" (160 mm) Z-DENS L = 6.8" L <sub>E</sub> = 4.8" - Stainless Steel
	2ZD2ZV6	Z-DENS Adaptor 6" (160 mm) Z-DENS to 6" Z-Vent L = 9.4" L <sub>E</sub> = 7.5" - Stainless Steel
	2ZDLAMT06	Z-DENS Adaptor - Laars MagnaTherm MGTH/V 1600 to 6" (160 mm) Z-DENS L = 8" L <sub>E</sub> = 6" - Stainless Steel
	2ZDWASF1006	Z-DENS Adaptor - Weil McLain Slim Fit (SF1000) 10" to 6" (160 mm) Z-DENS L = 13.9" L <sub>E</sub> = 11.3" - Stainless Steel
	2ZDAEDR6	Z-DENS Adaptor with High Temperature RTV Tube - Fulton Endura 6" to 6" (160mm) Z-DENS L = 6.5" L <sub>E</sub> = 4.3" - Stainless Steel
	2ZDAABM06	Z-DENS Adaptor with Viton® Gasket - Aerco Benchmark (BMK750/1000/1500) 6" to 6" (160 mm) Z-DENS L = 11.8" L <sub>E</sub> = 9.3" - Stainless Steel
	2ZDCDFA6	Z-DENS Adaptor - Camus Dyna Force 6" to 6" (160 mm) Z-DENS L = 13.4" L <sub>E</sub> = 11.0" - Stainless Steel
	2ZDAHf6	Z-DENS Adaptor 6" Saf-T-Vent to 6" (160 mm) Z-DENS - Stainless Steel

Product Catalogue & Dimensional Data  
**Z-DENS 6" Single Wall Rigid**  
 Polypropylene Vent System for High Efficiency Condensing Appliances

Image	Part ID	Description
	2ZDARA6	Z-DENS Adaptor - Riello Array 6" - Stainless Steel
	2ZDP624	Z-DENS Pipe 6" (160 mm) L = 24" L <sub>E</sub> = 21.5" UV-Grey
	2ZDP636	Z-DENS Pipe 6" (160 mm) L = 36" L <sub>E</sub> = 33.4" UV-Grey
	2ZDP672	Z-DENS Pipe 6" (160 mm) L = 72" L <sub>E</sub> = 69.5" UV-Grey
	2ZDTP6	Z-DENS Test Port 6" (160 mm) L = 9" L <sub>E</sub> = 6.5"
	2ZDTP6G	Z-DENS Test Port or Temperature Gauge with 1/8" -27 NPT Threads 6" (160 mm) L = 10.4" L <sub>E</sub> = 7.9" UV-Grey
	2ZDE645	Z-DENS Elbow 6" (160 mm) 45° L <sub>1</sub> = 4.6" L <sub>3</sub> = 4.5" L <sub>3E</sub> = 2.0" UV-Grey
	2ZDE687	Z-DENS Elbow 6" (160 mm) 87° L <sub>1</sub> = 6.4" L <sub>3</sub> = 6.3" L <sub>3E</sub> = 3.9" UV-Grey
	2ZDCD6H	Z-DENS Condensate Drain 6" (160 mm) L = 9" L <sub>E</sub> = 6.5" Drain O.D. = 1.26" Horizontal UV-Grey
	2ZDCT	Z-DENS Condensate Trap [Trap with 1.26" Inlet & 0.98" Outlet, 0.98" x 40"L Outlet Hose & <b>For 2" to 4" Diameters</b> (1.26 x 0.79" Reducer & <b>For Condensate Drains Installed Vertically:</b> 0.79" x Barb Fitting, 0.75" x 40"L Inlet Hose & Hose Clamp for Condensate Drain Connection)] H = 9.5"
	2ZDA6	Z-DENS Adaptor 6" (150 mm to 160 mm) L = 7.3" L <sub>E</sub> = 4.7" Concentric
	2ZDI68	Z-DENS Increaser 6" to 8" (160 to 200 mm) L = 12.2" L <sub>E</sub> = 7.9" Eccentric

# Z-DENS 6" Single Wall Rigid

Polypropylene Vent System for High Efficiency Condensing Appliances

Image	Part ID	Description
	2ZDR64	Z-DENS Reducer 6" to 4" (160 to 110 mm) L = 12.5" L <sub>E</sub> = 11.1" Concentric - Stainless Steel
	2ZDR86	Z-DENS Reducer 8" to 6" (200 to 160 mm) L = 10.6" L <sub>E</sub> = 8.1" Eccentric
	2SVSLS06	Z-DENS Storm Collar 6" (160 mm) W = 10" - Stainless Steel
	2SVSF06	Z-DENS Flat Flashing 6" (160 mm) 0° - 5° H = 12" W = 17" x 17" - Stainless Steel
	2SVSFA06	Z-DENS Adjustable Flashing 6" (160 mm) 0° - 30° H = 6" W = 20" x 20" - Stainless Steel
	2ZDTT6	Z-DENS Termination Tee with Screen 6" (160 mm) Stainless Steel
	2ZDES6	Z-DENS End Screen 6" (160 mm) Stainless Steel
	2ZDES6V	Z-DENS End Screen 6" (160 mm) VERTICAL - Stainless Steel. For use with 2ZDCC6 or 2ZDRT6
	2ZDCC6	Z-DENS Chimney Cover (RIGID) 6" (160 mm) H = 10.4" W = 13.6" x 13.6"
	2ZDRS6	Z-DENS Rigid Spacer 6" (160 mm) W = 15.8" (2 pieces) 1 Every 78" Centers Pipe in Chimney/Chase/B-Vent
	2ZDRBK6	Z-DENS Rigid Base Kit 6" (160 mm) L <sub>1</sub> = 6.4" L <sub>3</sub> = 6.3" L <sub>3E</sub> = 3.9" H = 13.8" W = 13.8" Bracket = 15.4"

Product Catalogue & Dimensional Data  
**Z-DENS 6" Single Wall Rigid**  
 Polypropylene Vent System for High Efficiency Condensing Appliances

Image	Part ID	Description
	2ZDHKLP6	Z-DENS Horizontal Kit Low Profile Adaptor - 6" CPVC/PVC (Iplex System 636) to 6" (160 mm) Z-DENS Vent & 6" CPVC/PVC Air L = 12" L <sub>E</sub> = 9.5" - Stainless Steel
	2ZDRT6	Z-DENS Roof Termination 6" (160 mm) H <sub>1</sub> = 35.8" H <sub>2</sub> = 59" with Bracket PPs/Galvanized-Black
	2ZDFF4	Z-DENS Flat Flashing 4"/6" (110/160 mm) or 6" (160 mm) 0° H = 5.9" W = 17.7"
	2SVSGB06	Z-DENS Guy Band 6" (160 mm) - Stainless Steel
	2ZDLC6	Z-DENS Locking Clamp (Accepts Threaded Rod or Lag Stud) 6"(160 mm)
	2ZDLC6B	Z-DENS Locking Clamp Band 6" (160 mm) 1/Joint Required
	2ZDFB6	Z-DENS Fixing Bracket/Support Clamp (Accepts Threaded Rod or Lag Stud) 6"(160 mm)
	2ZDGL	Z-DENS Gasket Lubricant
	2ZDG6	Z-DENS Gasket 6" (160 mm) Replacement Single Wall Rigid - Black EPDM
	2ZDG6V	Z-DENS Gasket 6" (160 mm) Replacement Single Wall Rigid - Red/Brown FKM (Viton®)

## Z-DENS 8" Single Wall Rigid

Polypropylene Vent System for High Efficiency Condensing Appliances

Image	Part ID	Description
	2ZDCPVC8	Z-DENS Adaptor 8" CPVC/PVC Coupling to 8" (200 mm) Z-DENS L = 13.7" L <sub>E</sub> = 9.6" - Stainless Steel
	2ZDCPVCG8	Z-DENS Adaptor Appliance with Gasket & Clamp 8" CPVC/PVC to 8" (200 mm) Z-DENS L = 13.7" L <sub>E</sub> = 9.6" - Stainless Steel
	2ZDZV8	Z-DENS Adaptor 8" Z-Vent to 8" (200 mm) Z-DENS L = 7" L <sub>E</sub> = 4.3" - Stainless Steel
	2ZD2ZV8	Z-DENS Adaptor 8" (200 mm) Z-DENS to 8" Z-Vent L = 11.8" L <sub>E</sub> = 9.9" - Stainless Steel
	2ZDLAMT08	Z-DENS Adaptor -Laars MagnaTherm MGTH/V 2000-2500 to 8" (200 mm) Z-DENS L = 9.1" L <sub>E</sub> = 5.8" - Stainless Steel
	2ZDWASF1008	Z-DENS Adaptor - Weil McLain Slim Fit (SF1000/1500/2000) 10" to 8" (200 mm) Z-DENS L = 15.3" L <sub>E</sub> = 11.3" - Stainless Steel
	2ZDAEDR8	Z-DENS Adaptor with High Temperature RTV Tube - Fulton Endura 8" to 8" (200 mm) Z-DENS L = 8.8" L <sub>E</sub> = 4.6" - Stainless Steel
	2ZDAABM08	Z-DENS Adaptor with Viton® Gasket - Aerco Benchmark (BMK 2000/2500/3000) 8" to 8" (200 mm) Z-DENS L = 11.8" L <sub>E</sub> = 8.5" - Stainless Steel
	2ZDCDFA8	Z-DENS Adaptor - Camus Dyna Force 8" to 8" (200 mm) Z-DENS - Stainless Steel
	2ZDAHf8	Z-DENS Adaptor 8" Saf-T-Vent to 8" (200 mm) Z-DENS - Stainless Steel
	2ZDARA8	Z-DENS Adaptor - Riello Array 8" - Stainless Steel
	2ZDP824	Z-DENS Pipe 8" (200 mm) L = 24" L <sub>E</sub> = 19.7" UV-Grey
	2ZDP836	Z-DENS Pipe 8" (200 mm) L = 36" L <sub>E</sub> = 31.7" UV-Grey
	2ZDP872	Z-DENS Pipe 8" (200 mm) L = 72" L <sub>E</sub> = 67.7" UV-Grey

Product Catalogue & Dimensional Data  
**Z-DENS 8" Single Wall Rigid**  
 Polypropylene Vent System for High Efficiency Condensing Appliances





Image	Part ID	Description
	2ZDTP8	Z-DENS Test Port 8" (200 mm) L = 16.5" L <sub>E</sub> = 12.2"
	2ZDTP8G	Z-DENS Test Port or Temperature Gauge with 1/8" - 27 NPT Threads 8" (200 mm) L = 16.5" L <sub>E</sub> = 12.2" UV-Grey
	2ZDE845	Z-DENS Elbow 8" (200 mm) 45° L <sub>1</sub> = 7.2" L <sub>3</sub> = 8.9" L <sub>3E</sub> = 4.6" UV-Grey
	2ZDE887	Z-DENS Elbow 8" (200 mm) 87° L <sub>1</sub> = 10.1" L <sub>3</sub> = 10" L <sub>3E</sub> = 5.6" UV-Grey
	2ZDCD8H	Z-DENS Condensate Drain 8" (200 mm) L = 16.7" L <sub>E</sub> = 12.4" Drain O.D. = 1.26" Horizontal UV-Grey
	2ZDCT	Z-DENS Condensate Trap [Trap with 1.26" Inlet & 0.98" Outlet, 0.98" x 40"L Outlet Hose & <b>For 2" to 4" Diameters</b> (1.26 x 0.79" Reducer & <b>For Condensate Drains Installed Vertically:</b> 0.79" x Barb Fitting, 0.75" x 40"L Inlet Hose & Hose Clamp for Condensate Drain Connection)] H = 9.5"
	2SVSLS08	Z-DENS Storm Collar 8" (200 mm) W = 12" - Stainless Steel
	2SVSF08	Z-DENS Flat Flashing 8" (200 mm) 0° - 5° H = 12" W = 22" x 22" - Stainless Steel
	2SVSFA08	Z-DENS Adjustable Flashing 8" (200 mm) 0° - 30° H = 6" W = 24" x 24" - Stainless Steel
	2ZDTT8	Z-DENS Termination Tee with Screen 8" (200 mm) Stainless Steel
	2ZDES8	Z-DENS End Screen 8" (200 mm) - Stainless Steel

# Z-DENS 8" Single Wall Rigid

Polypropylene Vent System for High Efficiency Condensing Appliances

Image	Part ID	Description
	2ZDES8V	Z-DENS End Screen 8" (200 mm) VERTICAL - Stainless Steel. For use with 2ZDCC8 or 2ZDRT8
	2ZDCC8	Z-DENS Chimney Cover (RIGID) 8" (200 mm) H = 10.3" W = 18.7" x 18.7"
	2ZDRS8	Z-DENS Rigid Spacer 8" (200 mm) W = 26.4" (2 pieces) 1 Every 78" Centers Pipe in Chimney/Chase/B-Vent
	2ZDRBK8	Z-DENS Rigid Base Kit 8" (200 mm) L <sub>1</sub> = 10.1" L <sub>3</sub> = 10" L <sub>3E</sub> = 5.6" H = 19.9" W = 13.8" Bracket = 23.6"
	2ZDRT8	Z-DENS Roof Termination 8" (200 mm) H <sub>1</sub> = 35.8" H <sub>2</sub> = 59" with Bracket PPs/ Galvanized- Black
	2ZDFF8	Z-DENS Flat Flashing 8" (200 mm) 0° H = 9.8" W = 19.7"
	2ZDAFM8	Z-DENS Adjustable Flashing Medium 8" (200 mm) 25° - 45° W = 39.4" x 27.6"
	2SVSGB08	Z-DENS Guy Band 8" (200 mm) - Stainless Steel
	2ZDLC8	Z-DENS Locking Clamp (Accepts Threaded Rod or Lag Stud) 8" (200 mm)
	2ZDLC8B	Z-DENS Locking Clamp Band 8" (200 mm) 1/2 Joint Required

Product Catalogue & Dimensional Data  
**Z-DENS 8" Single Wall Rigid**  
 Polypropylene Vent System for High Efficiency Condensing Appliances

Image	Part ID	Description
	2ZDFB8	Z-DENS Fixing Bracket/Support Clamp (Accepts Threaded Rod or Lag Stud) 8" (200 mm)
	2ZDGL	Z-DENS Gasket Lubricant
	2ZDG8	Z-DENS Gasket 8" (200 mm) Replacement Single Wall Rigid - Black EPDM
	2ZDG8V	Z-DENS Gasket 8" (200 mm) Replacement Single Wall Rigid - Red/Brown FKM (Viton®)

Product Catalogue & Dimensional Data  
**Z-DENS Cascade Systems**  
 Polypropylene Vent System for High Efficiency Condensing Appliances

Image	Part ID	Description
	2ZDCSK43	Z-DENS Cascade Starter Kit 4" x 3" (45°) x 25.6" L
	2ZDCEK43	Z-DENS Cascade Extension Kit 4" x 3" (45°) x 25.6" L
	2ZDCSK53	Z-DENS Cascade Starter Kit 5" x 3" (45°) x 40" L
	2ZDCEK53	Z-DENS Cascade Extension Kit 5" x 3" (45°) x 40" L
	2ZDCSK54	Z-DENS Cascade Starter Kit 5" x 4" (45°) x 40" L
	2ZDCEK54	Z-DENS Cascade Extension Kit 5" x 4" (45°) x 40" L
	2ZDCSK63	Z-DENS Cascade Starter Kit 6" x 3" (45°) x 40" L
	2ZDCEK63	Z-DENS Cascade Extension Kit 6" x 3" (45°) x 40" L
	2ZDCSK64	Z-DENS Cascade Starter Kit 6" x 4" (45°) x 40" L
	2ZDCEK64	Z-DENS Cascade Extension Kit 6" x 4" (45°) x 40" L
	2ZDCSK84	Z-DENS Cascade Starter Kit 8" x 4" (45°) x 44" L
	2ZDCEK84	Z-DENS Cascade Extension Kit 8" X 4" (45°) X 44" L

**Special  
Order**

Unique Items



2ZDNRV3 Z-DENS Non - Return Valve 3" L = 8.7" L<sub>E</sub> = 6.9" Swing Check with Water Lock Horizontal/Vertical



2ZDNR4 Z-DENS Non - Return Tee 4" L<sub>1</sub> = 5.9" L<sub>3E</sub> = 3.2" Ball Check Vertical

Starter Kit\*

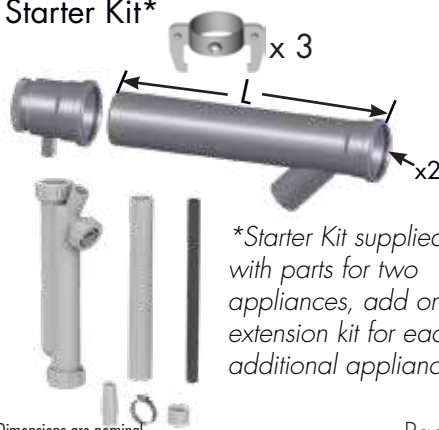

Extension Kit









*\*Starter Kit supplied with parts for two appliances, add on extension kit for each additional appliance.*

Product Catalogue & Dimensional Data  
**Z-DENS 2"/4" Concentric**  
 Polypropylene Vent System for High Efficiency Condensing Appliances

Image	Part ID	Description
" data-bbox="91 168 163 281"/>	2ZDCP2412	Z-DENS Concentric Pipe 2"/4" (60/100 mm) L = 12" L <sub>E</sub> = 10" PPs/Aluminum - White
" data-bbox="91 298 163 411"/>	2ZDCP2424	Z-DENS Concentric Pipe 2"/4" (60/100 mm) L = 24" L <sub>E</sub> = 22.1" PPs/Aluminum - White
" data-bbox="91 428 163 541"/>	2ZDCP2436	Z-DENS Concentric Pipe 2"/4" (60/100 mm) L = 36" L <sub>E</sub> = 34" PPs/Aluminum - White
" data-bbox="48 301 163 396"/> Unique Tech	2ZDCAP24	Z-DENS Concentric Adjustable Pipe 2"/4" (60/100 mm) L = 2.6" to 8.3" PPs/Aluminum-White
" data-bbox="91 403 163 476"/>	2ZDCTP24	Z-DENS Concentric Test Port 2"/4" (60/100 mm) L = 6.9" L <sub>E</sub> = 4.9" PPs/Aluminum-White
" data-bbox="81 488 173 561"/>	2ZDCE2445	Z-DENS Concentric Elbow 2"/4" (60/100 mm) 45° L <sub>1</sub> = 2.8" L <sub>3</sub> = 3.2" L <sub>3E</sub> = 1.2" PPs/Aluminum - White
" data-bbox="81 578 193 651"/>	2ZDCE2487	Z-DENS Concentric Elbow 2"/4" (60/100 mm) 87° L <sub>1</sub> = 4.3" L <sub>3</sub> = 4.7" L <sub>3E</sub> = 2.8" PPs/Aluminum - White
" data-bbox="91 668 178 751"/>	2ZDCD24	Z-DENS Concentric Drain 2"/4" (60/100 mm) L = 5.9" L <sub>E</sub> = 3.9" Drain O.D. = 0.79" Horizontal/Vertical PPs/Aluminum-White
	2ZDCT	Z-DENS Condensate Trap [Trap with 1.26" Inlet & 0.98" Outlet, 0.98" x 40"L Outlet Hose & <b>For 2" to 4" Diameters</b> (1.26 x 0.79" Reducer & <b>For Condensate Drains Installed Vertically:</b> 0.79" x Barb Fitting, 0.75" x 40"L Inlet Hose & Hose Clamp for Condensate Drain Connection)] H = 9.5"

## Z-DENS 2"/4" Concentric

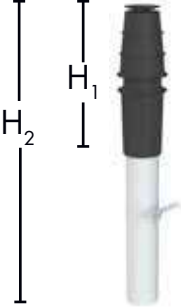
Polypropylene Vent System for High Efficiency Condensing Appliances

Image	Part ID	Description
	2ZDCHVK24	Z-DENS Concentric Horizontal Vent Kit 2"/4" (60 mm/100 mm) (Concentric Termination Horizontal, Concentric Elbow 87°, Concentric Pipe 36" Long & 2 Concentric Fixing Bracket)
	2ZDTG4	Z-DENS Termination Guard 6" x 6" Stainless Steel Horizontal
	2ZDCTH24	Z-DENS Concentric Termination Horizontal 2"/4" (60/100 mm) L = 31.5"
	2ZDCVVK24	Z-DENS Concentric Vertical Vent Kit 2"/4" (60 mm/100 mm) (Concentric Termination Vertical, Concentric Pipes 24" & 36" Long, Wall Plate & Concentric Fixing Bracket)
	2ZDCTV24	Z-DENS Concentric Termination Vertical 2"/4" (60/100 mm) H <sub>1</sub> = 21.4" H <sub>2</sub> = 45.3"
	2ZDCRT2440	Z-DENS Concentric Roof Termination EXTENSION 2"/4" (60/100 mm) with Guy Support Bracket L = 40" L <sub>E</sub> = 37.6"
	2ZDCRT2420	Z-DENS Concentric Roof Termination EXTENSION 2"/4" (60/100 mm) L = 20" L <sub>E</sub> = 17.9"
	2ZDFF2	Z-DENS Flat Flashing 2"/4" (60/100 mm) or 3"/5" (80/125 mm) 0° H = 3.9" W = 16.1"

Product Catalogue & Dimensional Data  
**Z-DENS 2"/4" Concentric**  
 Polypropylene Vent System for High Efficiency Condensing Appliances

Image	Part ID	Description
	2ZDAF2	Z-DENS Adjustable Flashing (Small) 2"/4" (60/100 mm) or 3"/5" (80/125 mm) 5° - 25° W = 19.3" x 19.3"
	2ZDAFM2	Z-DENS Adjustable Flashing Medium 2"/4" (60/100 mm) or 3"/5" (80/125 mm) 25° - 45° W = 19.7" x 19.7"
	2ZDCFB4	Z-DENS Concentric Fixing Bracket/Support Clamp (Accepts Threaded Rod or Lag Stud) 4" (100 mm) 1/Joint Required
	2ZDWPT24	Z-DENS Wall Plate Termination SUPPORT 2"/4" (60/100 mm) H = 6.7" W = 17.1" Aluminum-White
	2ZDWP4	Z-DENS Wall Plate 4" (100 mm) W = 7.6" Galvanized - White
	2ZDGL	Z-DENS Gasket Lubricant
	2ZDG2	Z-DENS Gasket 2" (60 mm) - Replacement Rigid or Concentric-Black EPDM
	2ZDG2V	Z-DENS Gasket 2" (60 mm) Replacement Rigid or Concentric Red/Brown FKM (Viton®)

# Z-DENS 3"/5" Concentric

Polypropylene Vent System for High Efficiency Condensing Appliances

Image	Part ID	Description
" data-bbox="108 168 182 278"/>	2ZDCP3512	Z-DENS Concentric Pipe 3"/5" (80/125 mm) L = 12" L <sub>E</sub> = 10" PPs/ Aluminum-White
" data-bbox="108 282 182 392"/>	2ZDCP3524	Z-DENS Concentric Pipe 3"/5" (80/125 mm) L = 24" L <sub>E</sub> = 22.1" PPs/ Aluminum-White
" data-bbox="108 396 182 506"/>	2ZDCP3536	Z-DENS Concentric Pipe 3"/5" (80/125 mm) L = 36" L <sub>E</sub> = 34" PPs/ Aluminum-White
" data-bbox="108 510 182 620"/> <span style="color: blue; font-weight: bold; border: 1px solid blue; border-radius: 50%; padding: 2px;">Unique Item</span>	2ZDCAP35	Z-DENS Concentric Adjustable Pipe 3"/5" (80/125 mm) L = 2.4" to 8.3" PPs/Aluminum-White
" data-bbox="108 624 182 734"/>	2ZDCTP35	Z-DENS Concentric Test Port 3"/5" (80/125 mm) L = 6.3" L <sub>E</sub> = 4.3" PPs/Aluminum-White
" data-bbox="108 738 182 848"/>	2ZDCE3545	Z-DENS Concentric Elbow 3"/5" (80/125 mm) 45° L <sub>1</sub> = 3.5" L <sub>3</sub> = 3.5" L <sub>3E</sub> = 1.6" PPs/Aluminum-White
" data-bbox="108 852 182 962"/>	2ZDCE3587	Z-DENS Concentric Elbow 3"/5" (80/125 mm) 87° L <sub>1</sub> = 4.7" L <sub>3</sub> = 5.1" L <sub>3E</sub> = 3.2" PPs/Aluminum-White
" data-bbox="108 966 182 1076"/>	2ZDCD35	Z-DENS Concentric Drain 3"/5" (80/125 mm) L = 6.3" L <sub>E</sub> = 4.3" Drain O.D. = 0.79" Horizontal/Vertical PPs/Aluminum-White
	2ZDCT	Z-DENS Condensate Trap [Trap with 1.26" Inlet & 0.98" Outlet, 0.98" x 40"L Outlet Hose & <b>For 2" to 4" Diameters</b> (1.26 x 0.79" Reducer & <b>For Condensate Drains Installed Vertically:</b> 0.79" x Barb Fitting, 0.75" x 40"L Inlet Hose & Hose Clamp for Condensate Drain Connection)] H = 9.5"

Product Catalogue & Dimensional Data  
**Z-DENS 3"/5" Concentric**  
 Polypropylene Vent System for High Efficiency Condensing Appliances

Image	Part ID	Description
	2ZDI2435	Z-DENS In increaser 2"/4" to 3"/5" (60/100 mm to 80/125 mm) L = 6.9" L <sub>E</sub> = 4.9" PPs/Aluminum-White
	2ZDCHVK35	Z-DENS Concentric Horizontal Vent Kit 3"/5" (80 mm/125 mm) (Concentric Termination Horizontal, Concentric Elbow 87°, Concentric Pipe 36" Long & 2 Fixing Bracket)
	2ZDTG5	Z-DENS Termination Guard 9"x 9" Stainless Steel Horizontal
	2ZDCTH35	Z-DENS Concentric Termination Horizontal 3"/5" (80/125 mm) L = 30.9"
	2ZDCVVK35	Z-DENS Concentric Vertical Vent Kit 3"/5" (80 mm/125 mm) (Concentric Termination Vertical, Concentric Pipes 24" & 36" Long, Wall Plate & Fixing Bracket)
	2ZDCTV35	Z-DENS Concentric Termination Vertical 3"/5" (80/125 mm) H <sub>1</sub> = 21.7" H <sub>2</sub> = 45.6"
	2ZDCRT3540	Z-DENS Concentric Roof Termination EXTENSION 3"/5" (80/125 mm) with Guy Support Bracket L = 40" L <sub>E</sub> = 37.6"
	2ZDCRT3520	Z-DENS Concentric Roof Termination EXTENSION 3"/5" (80/125 mm) L = 20" L <sub>E</sub> = 17.9"
	2ZDFF2	Z-DENS Flat Flashing 2"/4" (60/100 mm) or 3"/5" (80/125 mm) 0° H = 3.9" W = 16.1"

## Z-DENS 3"/5" Concentric

Polypropylene Vent System for High Efficiency Condensing Appliances

Image	Part ID	Description
	2ZDAF2	Z-DENS Adjustable Flashing (Small) 2"/4" (60/100 mm) or 3"/5" (80/125 mm) 5° - 25° W = 19.3" x 19.3"
	2ZDAFM2	Z-DENS Adjustable Flashing Medium 2"/4" (60/100 mm) or 3"/5" (80/125 mm) 25° - 45° W = 19.7" x 19.7"
	2ZDFB5	Z-DENS Fixing Bracket/Support Clamp (Accepts Threaded Rod or Lag Stud) 5" (125 mm)
	2ZDWPT35	Z-DENS Wall Plate Termination SUPPORT 3"/5" (80/125 mm) H = 7.7" W = 17.1" Aluminum-White
	2ZDWP5	Z-DENS Wall Plate 5" (125 mm) W = 9.1" Galvanized-White
	2ZDGL	Z-DENS Gasket Lubricant
	2ZDG3	Z-DENS Gasket 3" (80 mm) - Replacement Rigid or Concentric-Black EPDM
	2ZDG3V	Z-DENS Gasket 3" (80 mm) Replacement Rigid or Concentric Red/Brown FKM (Viton®)

Product Catalogue & Dimensional Data  
**Z-DENS 4"/6" Concentric**  
 Polypropylene Vent System for High Efficiency Condensing Appliances

Image	Part ID	Description
E = 10" PPs/Aluminum-White"/>	2ZDCP4612	Z-DENS Concentric Pipe 4"/6" (110/160 mm) L = 12" L <sub>E</sub> = 10" PPs/Aluminum-White
E = 22.1" PPs/Aluminum-White"/>	2ZDCP4624	Z-DENS Concentric Pipe 4"/6" (110/160 mm) L = 24" L <sub>E</sub> = 22.1" PPs/Aluminum-White
E = 34" PPs/Aluminum-White"/>	2ZDCP4636	Z-DENS Concentric Pipe 4"/6" (110/160 mm) L = 36" L <sub>E</sub> = 34" PPs/Aluminum-White
	2ZDCAP46	Z-DENS Concentric Adjustable Pipe 4"/6" (110/160 mm) L = 3.2" to 8.3" PPs/Aluminum-White
E = 3.9" Drain O.D. = 0.79" Horizontal/Vertical PPs/Aluminum-White"/>	2ZDCTP46	Z-DENS Concentric Drain 4"/6" (110/160 mm) L = 5.9" L <sub>E</sub> = 3.9" Drain O.D. = 0.79" Horizontal/Vertical PPs/ Aluminum-White
1 = 4.3" L <sub>3</sub> = 4.7" PPs/Aluminum-White"/>	2ZDCE4645	Z-DENS Concentric Elbow 4"/6" (110/160 mm) 45° L <sub>1</sub> = 4.3" L <sub>3</sub> = 4.7" PPs/Aluminum-White
1 = 7.3" L <sub>3</sub> = 9.1" L <sub>3E</sub> = 7.1" PPs/Aluminum-White"/>	2ZDCE4687	Z-DENS Concentric Elbow 4"/6" (110/160 mm) 87° L <sub>1</sub> = 7.3" L <sub>3</sub> = 9.1" L <sub>3E</sub> = 7.1" PPs/Aluminum-White
E = 3.9" Drain O.D. = 0.79" Horizontal/Vertical PPs/Aluminum-White"/>	2ZDCD46	Z-DENS Concentric Drain 4"/6" (110/160 mm) L = 5.9" L <sub>E</sub> = 3.9" Drain O.D. = 0.79" Horizontal/Vertical PPs/ Aluminum-White
	2ZDCT	Z-DENS Condensate Trap [Trap with 1.26" Inlet & 0.98" Outlet, 0.98" x 40"L Outlet Hose & <b>For 2" to 4" Diameters</b> (1.26 x 0.79" Reducer & <b>For Condensate Drains Installed</b> <b>Vertically:</b> 0.79" x Barb Fitting, 0.75" x 40"L Inlet Hose & Hose Clamp for Condensate Drain Connection)] H = 9.5"

# Z-DENS 4"/6" Concentric

Polypropylene Vent System for High Efficiency Condensing Appliances

Image	Part ID	Description
	2ZDI3546	Z-DENS In increaser 3"/5" to 4"/6" (80/125 mm to 110/160 mm) L = 6.5" L <sub>E</sub> = 4.5" PPs/Aluminum-White
	2ZDIS4646	Z-DENS In increaser Small 4"/6" (100/150 mm to 110/160 mm) L = 6.3" L <sub>E</sub> = 4.3"
	2ZDI4646	Z-DENS In increaser 4"/6" (110/150 mm to 110/160 mm) L = 6.9" L <sub>E</sub> = 4.9"
	2ZDCHVK46	Z-DENS Concentric Horizontal Vent Kit 4"/6" (110 mm/160 mm) (Concentric Termination Horizontal, Concentric Elbow 87°, Concentric Pipe 36" Long & 2 Fixing Bracket)
	2ZDTG6	Z-DENS Termination Guard 10" x 10" Stainless Steel Horizontal
	2ZDCTH46	Z-DENS Concentric Termination Horizontal 4"/6" (110/160 mm) L = 27"
	2ZDCVVK46	Z-DENS Concentric Vertical Vent Kit 4"/6" (110 mm/160 mm) (Concentric Termination Vertical, Concentric Pipes 24" & 36" Long, Wall Plate & Fixing Bracket)
	2ZDCTV46	Z-DENS Concentric Termination Vertical 4"/6" (110/160 mm) H <sub>1</sub> = 30.9" H <sub>2</sub> = 47"

Product Catalogue & Dimensional Data  
**Z-DENS 4"/6" Concentric**  
 Polypropylene Vent System for High Efficiency Condensing Appliances

Image	Part ID	Description
" data-bbox="118 164 241 204"/> Unique Item	2ZDFF4	Z-DENS Flat Flashing 4"/6" (110/160 mm) or 6" (160 mm) 0° H = 5.9" W = 17.7"
" data-bbox="126 226 233 298"/> Unique Item	2ZDAF4	Z-DENS Adjustable Flashing (Small) 4"/6" (110/160 mm) or 6" (160 mm) 5° - 25° W = 19.7" x 19.7"
" data-bbox="126 303 233 375"/> Unique Item	2ZDAFM4	Z-DENS Adjustable Flashing Medium 4"/6" (110/160 mm) 25° - 45° W = 23.6" x 19.7"
	2ZDFB6	Z-DENS Fixing Bracket/Support Clamp (Accepts Threaded Rod or Lag Stud) 6" (160 mm)
" data-bbox="106 466 216 564"/> Unique Item	2ZDWPT46	Z-DENS Wall Plate Termination SUPPORT 4"/6" (110/160 mm) H = 9.1" W = 17.1" Aluminum-White
	2ZDWP6	Z-DENS Wall Plate 6" (160 mm) W = 9.1" Galvanized- White
	2ZDGL	Z-DENS Gasket Lubricant
	2ZDG4	Z-DENS Gasket 4" (110 mm) - Replacement Rigid or Concentric-Black EPDM
	2ZDG4V	Z-DENS Gasket 4" (110 mm) Replacement Rigid or Concentric Red/Brown FKM (Viton®)

Z-Flex U.S., Inc. ("Z-Flex") provides a warranty for Z-DENS polypropylene products ("the Products") for a period of ten (10) years, expressly subject to the terms and conditions as set out in this Z-Flex warranty document ("the Warranty Document"). This Warranty Document is governed by the laws of the State of New Hampshire.

Z-Flex warrants that the Products are free of defects in material and workmanship for a period of ten (10) years after installation ("the Warranty Period"), provided that:

- The Products are installed, maintained and used in accordance with the Z-Flex installation instructions;
- The use of the Products is limited to those applications for which it was intended;
- The Products were purchased from an authorized Z-Flex dealer, retailer, or distributor;
- The Products were not modified or altered and not improperly serviced, inspected, or cleaned;
- Normal wear and tear, smoke damage, or damage caused by chimney fires is not covered by this warranty;
- Z-Flex expressly does not warrant that the Products are fit for purpose other than the purpose notified by Z-Flex in writing;
- The Products are inspected and maintained annually, beginning one (1) year after the date of installation and continuing throughout the Warranty Period;
- Proper installation, use, and maintenance is documented; and
- The system is installed by a professional installer.

If all obligations specified above are met, Z-Flex's obligation under this Warranty Document shall be limited to providing replacement parts for the defective and/or damaged (part of the) Product, provided that the claimant under the warranty:

- Notifies Z-Flex in writing within reasonable time after discovering the alleged defect or damage;
- Gives Z-Flex an opportunity to inspect the defective and/or damaged (part of the) Product prior to replacing it; and
- Submits a proof of purchase of the defective and/or damaged Product.

The warranty provided by Z-Flex shall not include the obligation to remove the defective (part of the) Product or the obligation to install the replacement (part of the) Product. Inspection, removal, labor, and installation costs are not covered by this warranty. The Warranty Period for the replacement (part of the) Product shall run for the remainder of the original Warranty Period for the defective and/or damaged Product.

The Product is intended solely for venting category II and IV appliances burning natural gas, propane, and oil. All other use of the Products is considered a misuse of the Product and voids the terms of this Warranty. Z-Flex accepts no responsibility for misuse of the Product.

The terms and conditions of this Warranty Document may not be modified, altered, varied or waived except with the express written approval of a corporate officer of Z-Flex.

The remedies described in this Warranty Document are the SOLE and EXCLUSIVE remedies Z-Flex shall provide. There are no warranties which extend beyond the description on the face of this Warranty Document. TO THE MAXIMUM EXTENT PERMITTED BY LAW, THE REMEDIES DESCRIBED IN THIS WARRANTY DOCUMENT ARE IN LIEU OF ANY AND ALL OTHER RIGHTS, INCLUDING WITHOUT LIMITATION ANY WARRANTY OF MERCHANTABILITY, FITNESS FOR A PARTICULAR PURPOSE, AND NON-INFRINGEMENT OF THIRD PARTY RIGHTS.

Z-Flex's liability for indirect and consequential damages including without limitation loss of profit, lost savings, and loss caused by interruption of operations, is expressly excluded. In no event shall Z-Flex's total liability exceed the purchase price of the Product, provided that Z-Flex's liability for indirect and consequential damages is expressly excluded.

Claims under this Warranty must be made within the warranty period in writing and directed to: In the USA; Warranty Claims, Z-Flex@US Inc., 20 Commerce Park North, Bedford, New Hampshire 03110, (603) 669-5136 or (800) 645-5600. In Canada; Warranty Claims, Z-Flex Inc., 452 Attwell Drive, Etobicoke, Ontario, M9W 5C3, (416) 679-0045. This Warranty gives you specific legal rights, and you may also have other rights that vary in different States and Provinces.

WARRANTY REGISTRATION CARD: Z-FLEX<sup>®</sup> For this warranty to be effective, this card must be completed upon purchase of the covered Z-DENS and returned to Z-Flex<sup>®</sup> within ninety (90) days of installation of the Z-DENS.

Original end-user's name: \_\_\_\_\_

Address of premises in which the Z-DENS is installed: \_\_\_\_\_

\_\_\_\_\_  
\_\_\_\_\_

Z-DENS purchased from: \_\_\_\_\_

Date of Installation: \_\_\_\_\_

Appliance Manufacture & Model which Z-DENS is installed \_\_\_\_\_

\_\_\_\_\_  
\_\_\_\_\_

I understand and agree to the Warranty as stated: \_\_\_\_\_

\_\_\_\_\_  
Signature Date



## Powerful New Quoting Tool

The current economic climate demands companies employ lean and innovative strategies.

**Z-Flex**<sup>®</sup> has pinpointed a need and brought to market cutting-edge technology with the new quoting tool **ZQuote**<sup>™</sup>. Use this free powerful application **NOW!** to accelerate response times and quickly produce the detailed quotes you need.

**ZQuote**<sup>™</sup> is a revolutionary software solution that can quickly create detailed, dimensioned **Z-FLEX**<sup>®</sup> Vent System Layouts, accurate bill of materials and a quote proposal.

**ZQuote**<sup>™</sup> virtually eliminates the need for time consuming AutoCad drawings.

- Step 1** Complete and submit the **ZQuote**<sup>™</sup> Design Checklist found on our website.
- Step 2** Design information is entered into **ZQuote**<sup>™</sup>
- Step 3** **ZQuote**<sup>™</sup> produces a detailed layout drawing with part call outs, bill of materials and a detailed price quote.

**ZQuote**<sup>™</sup> is a proprietary quote system for use with **Z-FLEX**<sup>®</sup> Vent Systems.

Typical applications for **Z-FLEX**<sup>®</sup> Vent Systems include:  
Boilers, Water Heaters, Tankless Water Heaters, Unit Heaters,  
Pool Heaters, Hot Water Boosters, Gas Fired Steam Humidifiers.



**Z-VENT<sup>®</sup> Smoothcore<sup>™</sup>**  
AL29-4C Stainless Steel flexible vent with smooth inside diameter for Category II, III & IV vent, in 2" to 8" with patented airtight Triple-Lock Construction & exclusive Z-LOK Tee.



**Z-VENT<sup>®</sup> Single or Double Wall**  
AL29-4C Stainless Steel rigid vent for Category II, III, & IV vent in 3" to 24" diameters with revolutionary double fail safe seal that dramatically reduces the installed vent time and cost.



**Triple Lock<sup>®</sup> & Fabriflex<sup>™</sup> Duct**  
Industry's strongest flexible air duct and connectors. Insulated, acoustical and mechanical lock with no adhesives. UL / ULC Listed for low, medium and high pressure applications.



**Platinum Flow<sup>™</sup>** Innovative **SELF SEALING**  
Round Duct System incorporates both factory installed EPDM double safe gaskets and calibrated sizing. Complete system available in single wall, double wall insulated, as well as custom design capabilities. Designed to exceed SMACNA's duct construction standards. Leakage Class 3.

# Z-FLEX®

## The Engineered Venting Systems Specialists

Recent developments in flue systems for use with high efficiency heating appliances, combined with the increased familiarity of use and installer confidence in polypropylene venting systems, has led to the development and continuous improvement of the polypropylene Z-DENS system.

**Z-Flex®** now offers the Z-DENS Polypropylene Venting System to our highly acclaimed product line-up.

*The NovaFlex Group® is a privately held company committed to continuous advancement in venting, HVAC, hose and connector solutions. NovaFlex® has one of the broadest product ranges available in the hose and ducting marketplace as well as in the HVAC, Industrial Venting and Hose Industries and in Commercial Exhaust Venting Systems.*

It is impossible to test all NovaFlex® and Z-Flex® products under all of the conditions to which they might be subjected in the field. It is therefore the buyer and/or end users' responsibility to test all products under conditions that duplicate service conditions prior to installation. Due to continuous improvements, technical data in this brochure is subject to change without notice. It is incumbent on installer to determine suitability of product for application and adhere to all local building codes that may or are applicable. Please defer to NovaFlex & Z-Flex terms and conditions of sale located at: [www.novaflex.com/TermsConditions/](http://www.novaflex.com/TermsConditions/)



---

### U.S.A.

20 Commerce Park North  
Bedford, New Hampshire 03110-6911  
tel: 603.669.5136 fax: 603.669.0309  
[www.z-flex.com](http://www.z-flex.com) email [sales@z-flex.com](mailto:sales@z-flex.com)

### CANADA

452 Attwell Drive  
Etobicoke, ON M9W 5C3  
tel: 416.679.0045 fax: 416.679.0051