

Section / Base Assembly Parts

Index		Notes	Part No.	
			321-811-120 Section Assembly, Complete With Heater Opening	
			321-811-125 Section Assembly, Complete Without Heater Opening	
A			311-800-014 Left Hand End Section With Heater Opening 1814	
A			311-800-007 Left Hand End Section Without Heater Opening 1813	
B			311-800-029 Right Hand End Section Without Heater Opening	
C			311-800-010 Intermediate Section 1815	
			381-800-667 Section Replacement Kit	
			592-800-010 3" Dia. Bottom Elastomer Seal	
			592-800-007 6" Dia. Bottom Elastomer Seal	
			590-735-122 Sealer For Sections	

Index		Notes	Part No.	
			513-000-002 Silicone -Used To Attach Rope Seal	
			560-234-480 ½" x 22¾" Tie Rod Without Nut	
			561-928-221 ½" Nut	
			562-248-668 ½" Lock Washer	
			591-602-913 Retort Cement	
			591-706-214 Flue Brush - 42" Long	
D			450-021-260 Draft Hood	
E			450-014-735 Collector Hood	
H			451-800-002 Front Base Panel	
I			451-800-012 Back Base Panel	
I2			451-800-022 Back Base Channel	
H1			510-811-660 Base Insulation Kit	
H2			451-800-042 Base Front Access Panel With Flame Rollout Switch Bracket	
H3			451-800-090 Back Burner Support	

Index		Notes	Part No.	
L1			389-900-103 Rectangular Tankless Cover Plate Kit With 8 Studs and Nuts and Tankless Gasket	
L2			590-317-579 Gasket For Heater Cover Plate	
L3			389-900-101 Cover Plate For Heater Opening	
L4			590-317-495 Gasket for cover plate	
F			512-200-000 Burner, Stainless Tube, Regular	
F1			512-200-002 Burner, Steel Tube With Pilot Bracket: "SPN" Systems Stainless	
			560-528-987 Main Burner Orifice, Natural Gas, 2.45mm	
			560-528-988 Main Burner Orifice, Propane Gas, 1.55mm	
J			451-800-070 Side Rail For Burner Pan With Bracket For Burner Pan	

Index		Notes	Part No.	
			560-340-577 Stud 3/8-16" NC-2A x 1.12 Long With 3/8-16" NC Brass Nut	
G			591-125-550 Manifold	
K			510-300-013 Spill Switch With Reset, 210°F	
			592-002-030 Touch Up Paint	

No
Diagram
Available

Parts List
Only

Water Trim / Control Parts

Index		Notes	Part No.	
			Control Parts For All EG Water Boilers With Tankless Heaters	
			511-330-097 Intermittent Pilot Ignition Module, 24 Volt	
			510-312-249 Combination High Limit / Low Limit / Circulator Control With Transformer	
			540-130-960 Wire Harness	
			592-300-027 ¾" N.P.T. Well, 4¼" Long For Hydrolevel 3250	
			510-312-166 Control Transformer/Relay Receptacle 120/24 Volt, 40 VA	
			Tankless Heater Parts For EG Water Boilers	
			590-921-905 Tankless Heater Water Boiler	
			560-340-577 Stud 3/8-16" NC-2A x 1.12 Long With 3/8-16" NC Brass Nut	

Index		Notes	Part No.	
			590-317-495 Gasket for cover plate	
			Trim Parts For All EG Water Boilers	
			383-600-091 ASME Pressure Relief Valve	
			510-218-097 Combination Pressure-Temperature Gauge	
			511-210-423 Drain Valve, 3/4" N.P.T., 1 1/2" Shank, Brass	
			510-148-567 Automatic Air Vent, Float Type, " N.P.T.	

Steam Trim / Control Parts

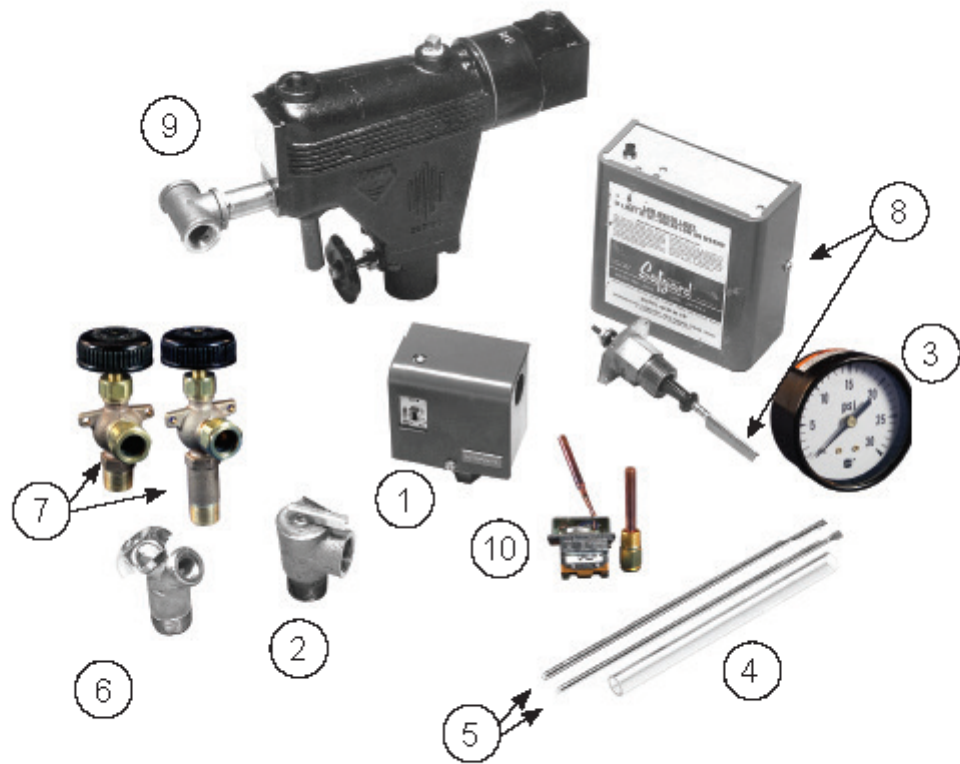

Steam Trim / Control Parts

Index		Notes	Part No.	
1			510-312-135 High Limit Steam Pressure Control	
2			383-600-106 Steam Relief Valve	
3			510-218-045 Pressure Gauge 0-30 PSIG, 2½" Dial, ¼" N.P.T. Bottom Mount	
4			383-600-000 Water Gauge Glass Kit, " x 73/8" With Gaskets and Brass Washers	
5			563-334-580 Water Gauge Glass Guard, 3/8" x 93/8"	
6			511-210-423 Drain Valve, ¾" N.P.T., 1½" Shank, Brass	
			590-921-903 Tankless Heater – Steam Boiler	
			Water Gauge Glass Cocks For Electrode Type Low Water Cut-Off	
7			510-218-145 Water Gauge Glass Cocks, Set ½" N.P.T. Male Inlet	

Index		Notes	Part No.	
			Water Gauge Glass Cocks For # 67 Float Type Low Water CutOff	
7			510-218-135 Water Gauge Glass Cocks, Set, ½" N.P.T., Female Inlet, Standard Stem	
			Electrode Type Low Water Cut-Off Components	
8			510-811-403 Low Water Cut-Off, Electrode Type, SPDT, 24 Volt, ¾" Male N.P.T, With Instructions, Adapter, and Bushing	
			540-130-962 Wire Harness, Probe LWCO Only	
			560-640-696 90° Syphon, ¼" N.P.T., Brass	
			Float Type Low Water Cut-Off Components For EC Steam Boilers	
9			511-114-494 Low Water Cut-off, SPDT, ½" N.P.T. Float Type, 24 Volt	

Index		Notes	Part No.	
			540-130-961 Wire Harness, Float LWCO Only	
			Control Components For Steam Boiler With Tankless Heater	
10			510-312-250 High Limit Temperature Control, Auto Recycle, 140-240° F, 30° Fixed Subtractive Differential, With ½" N.P.T Well	
			511-330-097 Intermittent Pilot Ignition Module, 24 Volt	
			510-312-166 Control Transformer/Relay Receptacle 120/24 Volt, 40 VA	