

Webstone®

a brand of **NIBCO®**

PRODUCT CATALOG



**TEMPERATURE
CONTROL
VALVES**

TWH SERVICE VALVES
E·X·P
SERIES

**UNDER BOILER
SOLUTIONS**

HYDRO-CORE™

PRO-PAL
SERIES

The ISOLATOR®
UNI-FLANGE BALL VALVE

PEX PRODUCTS

PRO-CONNECT
PPR PRO

PRO-CONNECT
PRO PUSH

PRO-CONNECT
PRESS

BALL VALVES

**VALVE INNOVATION
GUARANTEED FOR LIFE**

CONDITIONS APPLY. SEE WEBSTONEVALVES.COM FOR FULL DETAILS.

WORK SMARTER

TEMPERATURE CONTROL PRODUCTS

Thermostatic Mixing Valves	4
Water Heater Tempering Valve	9
E-X-P™ Series Tankless Water Heater Kits	10
Add-A-Gauge Tool	12

UNDER BOILER SOLUTIONS

Hydro-Core™	14
E-X-P™ Series Wall Hung & Combi Boiler Kits	17
Magnetic Boiler Filter	18
Differential Pressure By-Pass Valve	19
Hydronic G1 Union Accessories	19
Air Separators	20

PRO-PAL® SERIES

Ball Drain™	22
Union Ball Drain™	23
Union Ball™	23
T-Drain™	24
Purge-Tee™	24
Purge & Fill™	25
Expansion Tank Pro Service Valve™	25

THE ISOLATOR®

Rotating Flange	26
Uni-Flange Ball Valve	27
Double Flanged Check	27
Round Flange	28
Select	28

CONNECTIONS FOR EVERY JOB

F1960 & F1807 PEX Products	30
PEX Transition Valves & Fittings	31
Pro-Connect PP-R Pro™	32
Pro-Connect ProPush™	34
Pro-Connect Press™	36

BALL VALVES

Brass Ball Valves	37
Gas Ball Valves	38
Mini Ball Valves	38
Stainless Steel Ball Valves	39

LOW PRESSURE PRODUCTS

Gate Valves	39
Radiator Valves	39
Boiler Drains	39
Check Valves	40
Sillcocks	40
Hose Bibbs	40
Unions	40

INDEX	41
--------------	-----------

SAVE TIME, SAVE SPACE & SAVE LABOR

REPLACES
220
COMPONENTS

SAVES OVER
26
HOURS

ELIMINATES
177
LEAK PATHS

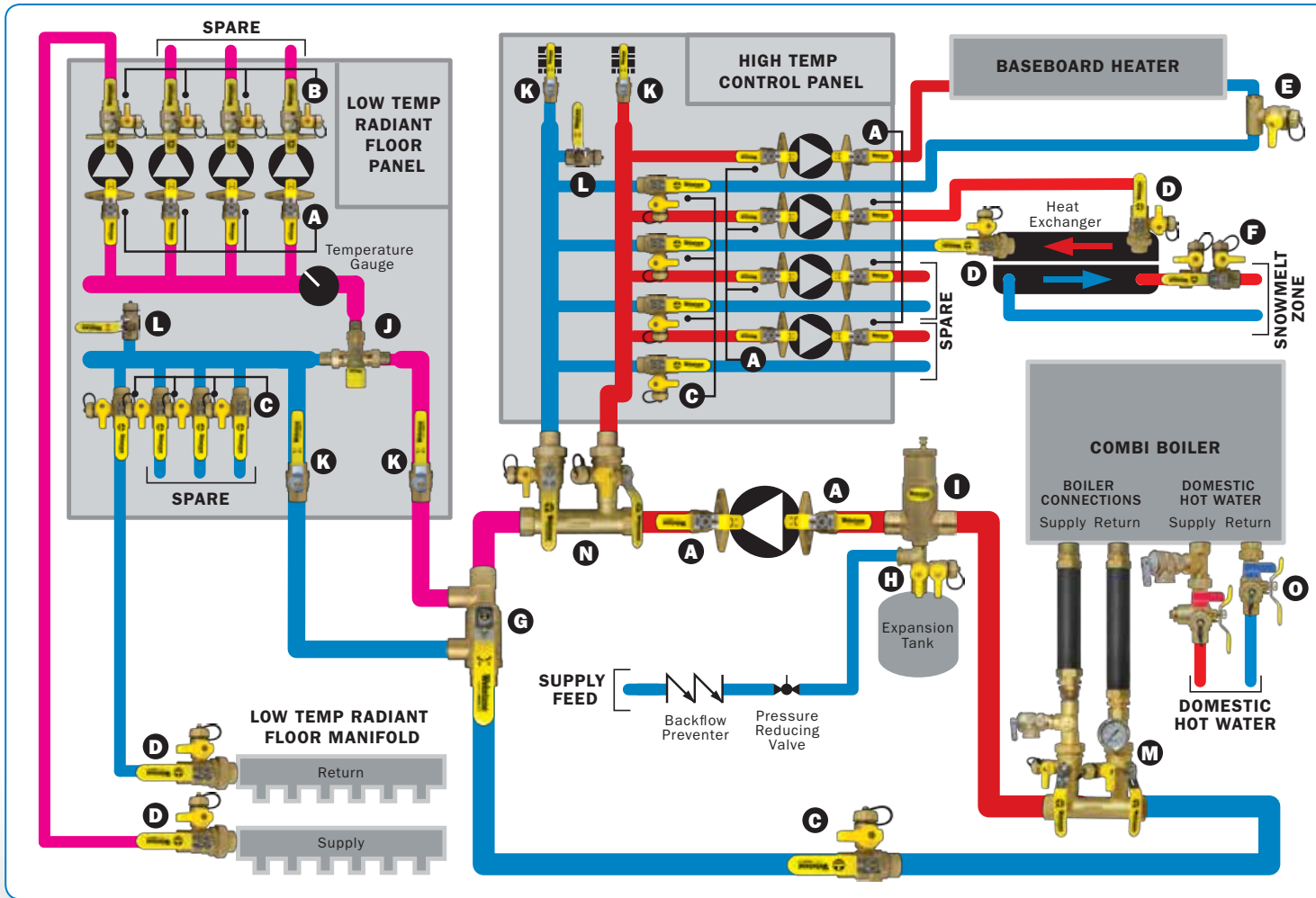

THERMOSTATIC MIXING VALVES

RIGHT TEMPERATURE RIGHT CONNECTION

- Mixes hot and cold water to pre-set output temperature
- Heavy duty lead-free forged brass construction
- Temperature locking handle on select models
- Select models include integral check valves on inlets
- Sizes 3/8" - 1"
- Wide range of G1 Union Accessories and Kits offer a solution for most installation needs

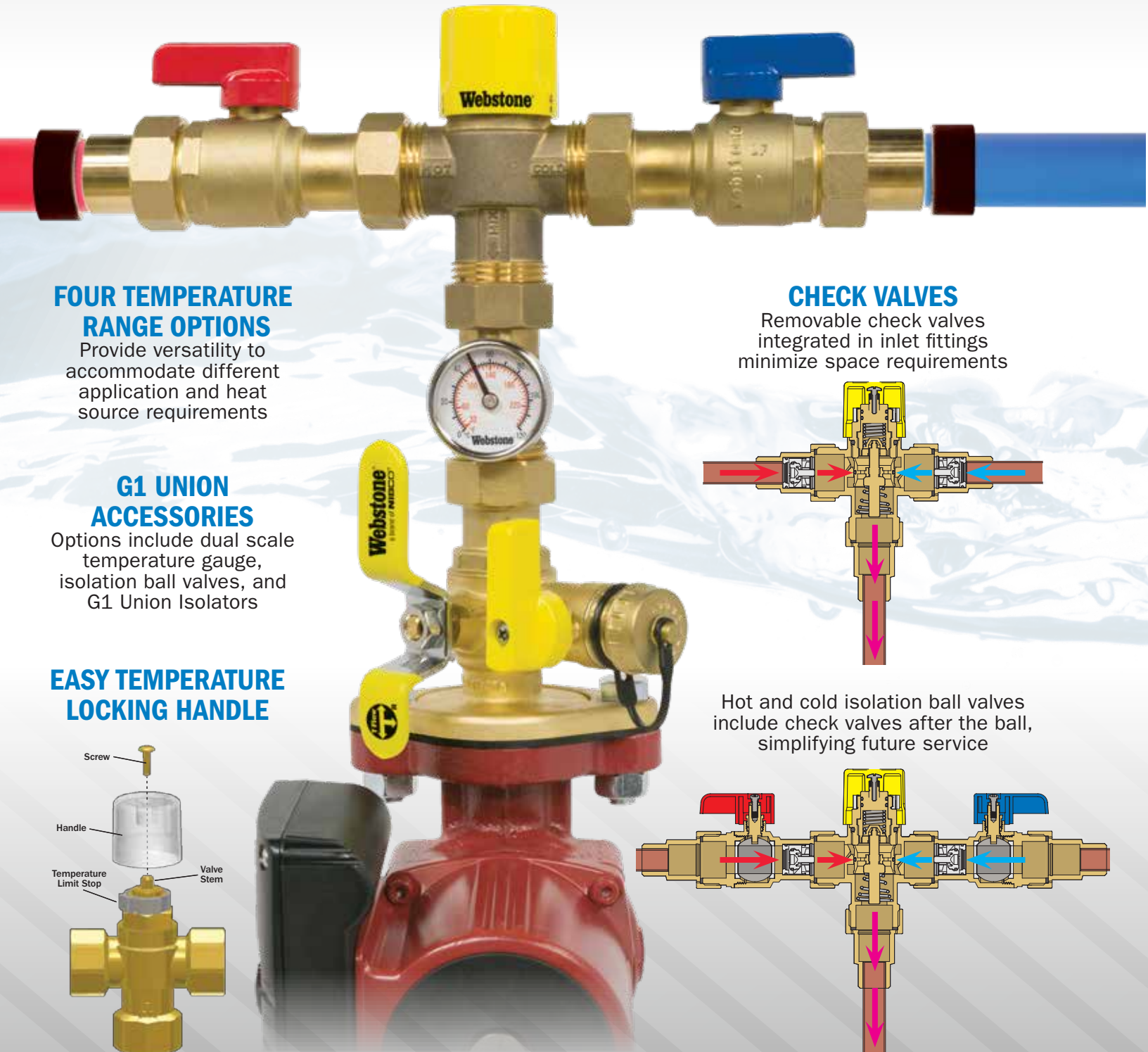

FOUR TEMPERATURE RANGE OPTIONS

Provide versatility to accommodate different application and heat source requirements

G1 UNION ACCESSORIES

Options include dual scale temperature gauge, isolation ball valves, and G1 Union Isolators

EASY TEMPERATURE LOCKING HANDLE

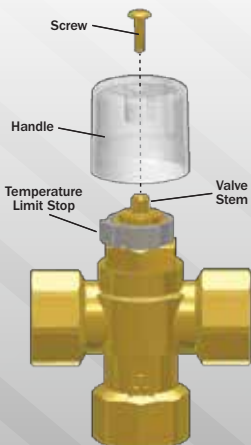

CHECK VALVES

Removable check valves integrated in inlet fittings minimize space requirements

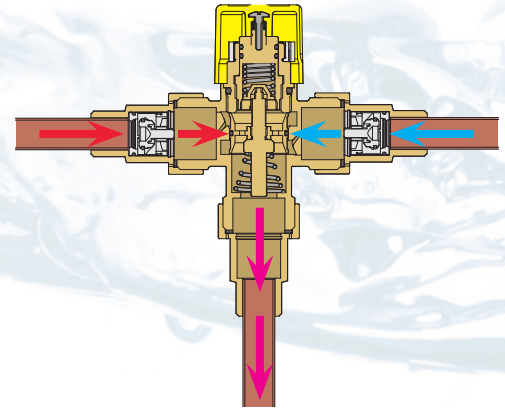

Hot and cold isolation ball valves include check valves after the ball, simplifying future service

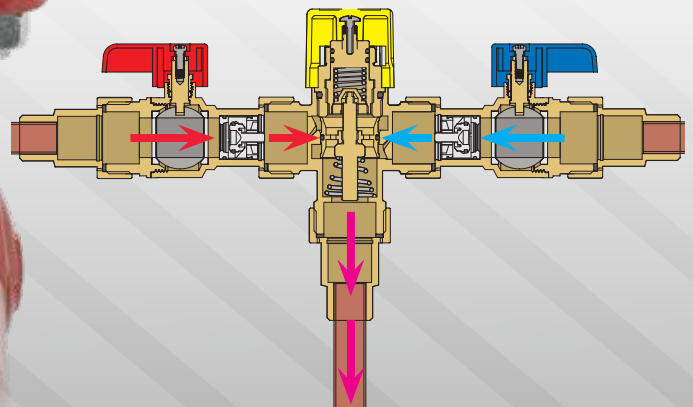

APPLICATIONS

WATER DISTRIBUTION SYSTEMS

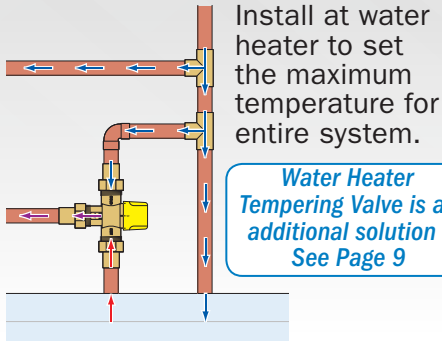

LOW TEMP HYDRONIC

Set a maximum temperature up to 131°F for radiant floor or other low temp heating application

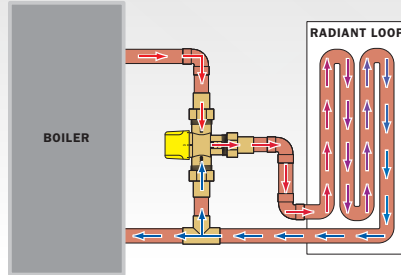

HIGH TEMP HYDRONIC

Set a maximum temperature up to 176°F for radiant floor, baseboard heat, radiators, or other high temp heating application

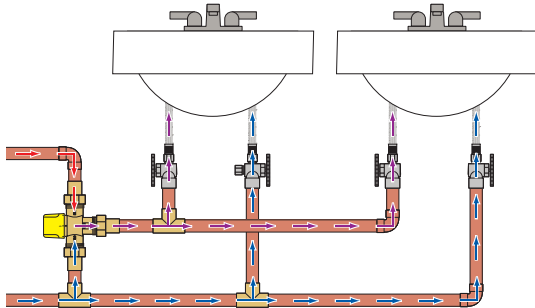
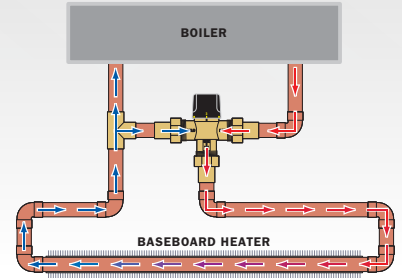

POINT OF USE - MULTI FIXTURE

Set the maximum temperature for a group of fixtures

Ultra-Compact TMV ideal for Single Fixture Point of Use - See Page 8

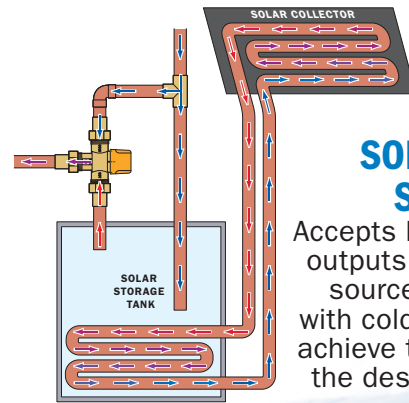

SOLAR HEAT SOURCE

Accepts high temperature outputs from solar heat sources, then mixes with cold water supply to achieve temperatures for the desired application

FOUR TEMPERATURE RANGES

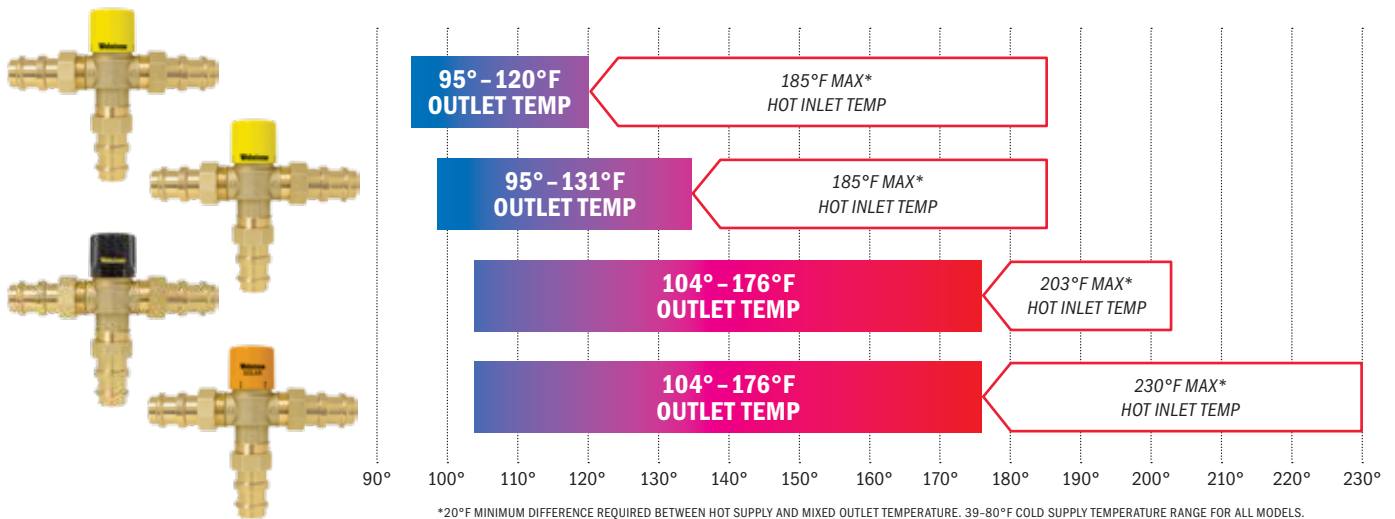

Customize your installation and simplify future service with a full selection of

G1 UNION ACCESSORIES & ISOLATION KITS

SEE PAGE 7 FOR DETAILS



THERMOSTATIC MIXING VALVES

APPLICATION	WATER DISTRIBUTION SYSTEMS Certified to NSF/ANSI 61 & 372 ASSE 1017 CSA B125.3 - Body (H-70000W) certified by CSA to ASSE 1017		LOW TEMP HYDRONIC	HIGH TEMP HYDRONIC	SOLAR HEAT SOURCE	POINT OF USE		
	Certified to NSF/ANSI 61 & 372 ASSE 1017 - Body (H-70060W) certified by CSA to ASSE 1017				SINGLE OR MULTI FIXTURE Certified to NSF/ANSI 61 & 372 ASSE 1017, 1070 CSA B125.3		SINGLE ONLY Certified to NSF/ANSI 61 & 372 ASSE 1070	
MIXED OUTPUT TEMP RANGE	95° - 120°F (35° - 49°C)	95° - 131°F (35° - 55°C)	95° - 131°F (35° - 55°C)	104° - 176°F (40° - 80°C)	104° - 176°F (40° - 80°C)	95° - 120°F (35° - 49°C)	95° - 131°F (35° - 55°C)	95° - 120°F (35° - 49°C)
HOT INLET TEMP	185°F MAX	185°F MAX	185°F MAX	203°F MAX	230°F MAX	185°F MAX	185°F MAX	180°F MAX
FIP	7220W-CAN	7220W	7220W	7227W	7216W	-	-	-
MIP	7420W-CAN	7420W	7420W	7427W	7416W	7420W-CAN	7420W	-
SWT	7520W-CAN	7520W	7520W	7527W	7516W	7520W-CAN	7520W	-
PRESS	7820W-CAN	7820W	7820W	7827W	7816W	-	-	-
PUSH	7620W-CAN	7620W	7620W	-	-	-	-	7761W - See Page 8
COMPRESSION	-	-	-	-	-	-	-	7720W/7740W - See Page 8
F1960 PEX	7320W-CE-CAN	7320W-CE	7320W-CE	7327W	-	-	-	-
F1807 PEX	7120W-CAN	7120W	7120W	7127W	-	-	-	-

THERMOSTATIC MIXING VALVE W/ INTEGRAL CHECK VALVES

Forged Brass Valve w/ DZR Brass Fittings
& G1 Union Connections
Outlet Temperature Range 95° - 120°F

LEAD-FREE BRASS

SIZE	ITEM#	CTN/CASE	CASE WT
FIP 150 PSI/185°F Max			
1/2"	H-72202W-CAN	1/10	21
3/4"	H-72203W-CAN	1/10	22
1"	H-72204W-CAN	1/10	24
MIP 150 PSI/185°F Max			
1/2"	H-74202W-CAN	1/10	19
3/4"	H-74203W-CAN	1/10	19
1"	H-74204W-CAN	1/10	22
SWT 150 PSI/185°F Max			
1/2"	H-75202W-CAN	1/10	19
3/4"	H-75203W-CAN	1/10	19
1"	H-75204W-CAN	1/10	20
Press 150 PSI/185°F Max			
1/2"	H-78202W-CAN	1/10	19
3/4"	H-78203W-CAN	1/10	21
1"	H-78204W-CAN	1/10	22
Push 150 PSI/185°F Max			
1/2"	H-76202W-CAN*	1/10	21
3/4"	H-76203W-CAN*	1/10	22
ASTM F1960 PEX 150 PSI/185°F Max			
1/2"	H-73202W-CE-CAN	1/10	18
3/4"	H-73203W-CE-CAN	1/10	18
ASTM F1807 PEX 150 PSI/185°F Max			
1/2"	H-71202W-CAN*	1/10	18
3/4"	H-71203W-CAN*	1/10	18
BODY ONLY - INSTALL W/ (3) G1 UNION FITTINGS			
G1 Thread 150 PSI/185°F Max			
1"	H-70000W-CAN	1/10	12

*NEW ITEM NUMBER - FORMERLY H-7320W-CAN SERIES
†PUSH FITTINGS CERTIFIED TO ASSE 1061



THERMOSTATIC MIXING VALVE W/ INTEGRAL CHECK VALVES

Forged Brass Valve w/ DZR Brass Fittings,
Temperature Locking Handle
& G1 Union Connections
Outlet Temperature Range 95° - 131°F

LEAD-FREE BRASS

SIZE	ITEM#	CTN/CASE	CASE WT
FIP 150 PSI/185°F Max			
1/2"	H-72202W	1/10	21
3/4"	H-72203W	1/10	22
1"	H-72204W	1/10	24
MIP 150 PSI/185°F Max			
1/2"	H-74202W	1/10	19
3/4"	H-74203W	1/10	19
1"	H-74204W	1/10	23
SWT 150 PSI/185°F Max			
1/2"	H-75202W	1/10	17
3/4"	H-75203W	1/10	19
1"	H-75204W	1/10	22
Press 150 PSI/185°F Max			
1/2"	H-78202W	1/10	20
3/4"	H-78203W	1/10	21
1"	H-78204W	1/10	22
Push 150 PSI/185°F Max			
1/2"	H-76202W*	1/10	21
3/4"	H-76203W*	1/10	22
ASTM F1960 PEX 150 PSI/185°F Max			
1/2"	H-73202W-CE	1/10	18
3/4"	H-73203W-CE	1/10	18
ASTM F1807 PEX 150 PSI/185°F Max			
1/2"	H-71202W*	1/10	18
3/4"	H-71203W*	1/10	18
BODY ONLY - INSTALL W/ (3) G1 UNION FITTINGS			
G1 Thread 150 PSI/185°F Max			
1"	H-70000W	1/10	12

*NEW ITEM NUMBER - FORMERLY H-7320W SERIES
†PUSH FITTINGS CERTIFIED TO ASSE 1061

THERMOSTATIC MIXING VALVE W/ INTEGRAL CHECK VALVES

Forged Brass Valve w/ DZR Brass Fittings,
Temperature Locking Handle
& G1 Union Connections
Outlet Temperature Range 104° - 176°F

LEAD-FREE BRASS

SIZE	ITEM#	CTN/CASE	CASE WT
FIP 150 PSI/203°F Max			
1/2"	H-72272W	1/10	21
3/4"	H-72273W	1/10	22
1"	H-72274W	1/10	24
MIP 150 PSI/203°F Max			
1/2"	H-74272W	1/10	19
3/4"	H-74273W	1/10	19
1"	H-74274W	1/10	23
SWT 150 PSI/203°F Max			
1/2"	H-75272W	1/10	17
3/4"	H-75273W	1/10	19
1"	H-75274W	1/10	22
Press 150 PSI/203°F Max			
1/2"	H-78272W	1/10	20
3/4"	H-78273W	1/10	21
1"	H-78274W	1/10	22
ASTM F1960 PEX 150 PSI/203°F Max			
1/2"	H-73272W	1/10	18
3/4"	H-73273W	1/10	18
ASTM F1807 PEX 150 PSI/203°F Max			
1/2"	H-71272W	1/10	18
3/4"	H-71273W	1/10	18
BODY ONLY - INSTALL W/ (3) G1 UNION FITTINGS			
G1 Thread 150 PSI/203°F Max			
1"	H-70070W	1/10	12

THERMOSTATIC MIXING VALVE









Forged Brass Valve w/ DZR Brass Fittings,
Temperature Locking Handle
& G1 Union Connections
For Solar Applications - Max Input 230°F
Outlet Temperature Range 104° - 176°F

LEAD-FREE BRASS

SIZE	ITEM#	CTN/CASE	CASE WT
FIP 150 PSI/230°F Max			
1/2"	H-72162W	1/10	21
3/4"	H-72163W	1/10	22
1"	H-72164W	1/10	24
MIP 150 PSI/230°F Max			
1/2"	H-74162W	1/10	19
3/4"	H-74163W	1/10	19
1"	H-74164W	1/10	23
SWT 150 PSI/230°F Max			
1/2"	H-75162W	1/10	17
3/4"	H-75163W	1/10	19
1"	H-75164W	1/10	22
Press 150 PSI/230°F Max			
1/2"	H-78162W	1/10	20
3/4"	H-78163W	1/10	21
1"	H-78164W	1/10	22
BODY ONLY - INSTALL W/ (3) G1 UNION FITTINGS			
G1 Thread 150 PSI/230°F Max			
1"	H-70060W	1/10	12

TMV ISOLATION KITS

- Isolates TMV body for service
- Versatile combinations cover most TMV installations
- Easily re-arrange color-coded handles/check valves to valve bodies in accordance with system needs
- Compatible with G1 Union Connections

	ISOLATION BALL VALVE			ANGLED ISOLATION BALL VALVE			The ISOLATOR [®] UNI-FLANGE BALL VALVE	
								
H-7-G234W-KITA		✓	✓					
H-7-G234W-A-KITA					✓	✓		
H-7-G234W-KITB	✓	✓	✓					
H-7-G234W-A-KITB	✓				✓	✓		
H-7-G234W-KITD				✓				
H-G1404W-KITB		✓	✓				✓	
H-G1404W-A-KITB					✓	✓	✓	
H-G1414W-KITB		✓	✓					✓
H-G1414W-A-KITB					✓	✓		✓

TMV G1 UNION ACCESSORIES



ISOLATION BALL VALVE
Full Port Forged DZR Brass Valve

LEAD-FREE BRASS
Certified to NSF/ANSI 61 & 372

SIZE	ITEM#	CTN/CASE
G1 Union × G1 Thread	150 PSI CWP Max	
W/ REVERSIBLE YELLOW HANDLE		
1"	H-7-G134WY	10/60
W/ INTEGRAL CHECK VALVE & REVERSIBLE RED HANDLE		
1"	H-7-G234WR	10/60
W/ INTEGRAL CHECK VALVE & REVERSIBLE BLUE HANDLE		
1"	H-7-G234WB	10/60



THE ISOLATOR W/ ROTATING FLANGE
Full Port Forged DZR Brass Uni-Flange Ball Valve - w/ Detachable Rotating Flange, Adjustable Packing Gland, Nuts & Bolts

LEAD-FREE BRASS
Certified to NSF/ANSI 61 & 372

SIZE	ITEM#	HV ITEM#	CTN/CASE
G1 Union × Rotating Flange	600 PSI CWP Max		
1"	H-G1404W	H-G1404WHV	1/20
W/ MULTI-FUNCTION HI-FLOW HOSE DRAIN			
1"	H-G1414W	H-G1414WHV	1/20

HV ITEMS FIT HIGH VELOCITY & STANDARD SIZE PUMPS.



DUAL SCALE TEMPERATURE GAUGE
w/ Integrated Forged Brass Fitting · 1½" Dial Temperature Range 32° - 248°F

LEAD-FREE BRASS
Certified to NSF/ANSI 61 & 372

SIZE	ITEM#	CTN/CASE
G1 Union × G1 Thread		
1"	H-32000W	10/100

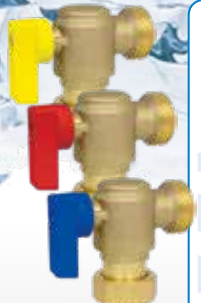

ANGLED ISOLATION BALL VALVE
Full Port Forged DZR Brass Valve

LEAD-FREE BRASS
Certified to NSF/ANSI 61 & 372

SIZE	ITEM#	CTN/CASE
G1 Union × G1 Thread	150 PSI CWP Max	
W/ REVERSIBLE YELLOW HANDLE		
1"	H-7-G134WY-A	10/60
W/ INTEGRAL CHECK VALVE & REVERSIBLE RED HANDLE		
1"	H-7-G234WR-A	10/60
W/ INTEGRAL CHECK VALVE & REVERSIBLE BLUE HANDLE		
1"	H-7-G234WB-A	10/60



G1 UNION ELBOW
Forged DZR Brass Fitting

LEAD-FREE BRASS
Certified to NSF/ANSI 61 & 372

SIZE	ITEM#	CTN/CASE
G1 Union × G1 Thread	150 PSI CWP Max	
1"	H-7-G144W-A	10/60

HIGH-TEMP CHECK VALVES

Replaces included in-line check valves when using select isolation ball valves with high-temp solar heat sources



SET OF 2 IN-LINE CHECK INSERTS & RETAINING RINGS
For Use With Webstone G1 Fittings For Solar Applications - Max Input 230°F

SIZE	ITEM#	CTN/CASE
150 PSI/230°F Max		
3/4"	H-C7-303	10/100

G1 UNION FITTINGS

Pair with body-only TMVs or other union accessories to eliminate additional adapters or accommodate other unique installation needs

	FIP	MIP	SWT	Press	Push	ASTM F1960 PEX	ASTM F1807 PEX
Forged DZR Brass Fitting							
1/2"	H-7-2102W WP	H-7-4102W WP	H-7-5102W WP	H-7-8102W WP	H-7-6102W WP	H-7-3102W WP	H-7-1102W WP
3/4"	H-7-2103W WP	H-7-4103W WP	H-7-5103W WP	H-7-8103W WP	H-7-6103W WP	H-7-3103W WP	H-7-1103W WP
1"	H-7-2104W WP	H-7-4104W WP	H-7-5104W WP	H-7-8104W WP	-	-	-
Forged DZR Brass Fitting with Integral Check Valve							
1/2"	H-7-2202W WP	H-7-4202W WP	H-7-5202W WP	H-7-8202W WP	H-7-6202W WP	H-7-3202W WP	H-7-1202W WP
3/4"	H-7-2203W WP	H-7-4203W WP	H-7-5203W WP	H-7-8203W WP	H-7-6203W WP	H-7-3203W WP	H-7-1203W WP
1"	H-7-2204W WP	H-7-4204W WP	H-7-5204W WP	H-7-8204W WP	-	-	-

ULTRA-COMPACT THERMOSTATIC MIXING VALVE

- Ultra-compact 2½" × 3¼" body
- Ideal for discrete under sink installations
- 95–120°F output range with locking handle
- Factory preset at 120°F
- Integral check valves and strainers on inlets
- Cold water by-pass models include elbow and tee shown
- Optional temperature gauge available
- Includes mounting bracket
- Chrome-plated forged brass or chrome-plated bronze body options

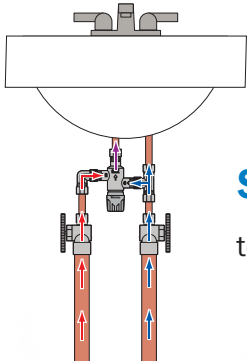

POINT-OF-USE - SINGLE FIXTURE
Set the maximum temperature of each fixture individually



ACTUAL SIZE

CHROME-PLATED FORGED DZR BRASS THERMOSTATIC MIXING VALVE
For Point-of-Use (Single Fixture)
Outlet Temperature Range 95°- 120°F

LEAD-FREE BRASS
Certified to NSF/ANSI 61 & 372 ASSE 1070

SIZE	ITEM#	CTN/CASE	CASE WT
Compression		150 PSI/180°F Max	
3/8"	H-77201W	10/60	31
W/ 20-220°F TEMPERATURE GAUGE			
3/8"	H-77201W-TG	10/60	40

CHROME-PLATED FORGED DZR BRASS THERMOSTATIC MIXING VALVE
w/ Cold Water By-Pass Fittings
Outlet Temperature Range 95°- 120°F

LEAD-FREE BRASS
Certified to NSF/ANSI 61 & 372 ASSE 1070

SIZE	ITEM#	CTN/CASE	CASE WT
Compression		150 PSI/180°F Max	
3/8"	H-77211W	10/60	44
Push		150 PSI/180°F Max	
1/4"	H-77610W*	10/60	44
W/ 20-220°F TEMPERATURE GAUGE			
Compression		150 PSI/180°F Max	
3/8"	H-77211W-TG	10/60	53
Push		150 PSI/180°F Max	
1/4"	H-77610W-TG*	10/60	53

*Also certified to ASSE 1061

DUAL SCALE TEMPERATURE GAUGE
w/ Integrated Chrome-Plated Forged DZR Brass Fitting
1" Dial - Temperature Range 20 - 220° F

LEAD-FREE BRASS
Certified to NSF/ANSI 61 & 372

SIZE	ITEM#	CTN/CASE	CASE WT
Compression		150 PSI	
3/8"	H-33000W	10/100	16

CHROME-PLATED BRONZE THERMOSTATIC MIXING VALVE
For Point-of-Use (Single Fixture)
Outlet Temperature Range 95°- 120°F

LEAD-FREE
Certified to NSF/ANSI 61 & 372 ASSE 1070

SIZE	ITEM#	CTN/CASE	CASE WT
Compression		150 PSI/180°F Max	
3/8"	H-77401W	10/60	31
W/ 20-220°F TEMPERATURE GAUGE			
3/8"	H-77401W-TG	10/60	40

CHROME-PLATED BRONZE THERMOSTATIC MIXING VALVE
w/ Cold Water By-Pass Fittings
Outlet Temperature Range 95°- 120°F

LEAD-FREE
Certified to NSF/ANSI 61 & 372 ASSE 1070

SIZE	ITEM#	CTN/CASE	CASE WT
Compression		150 PSI/180°F Max	
3/8"	H-77411W	10/60	44
W/ 20-220°F TEMPERATURE GAUGE			
Compression		150 PSI/180°F Max	
3/8"	H-77411W-TG	10/60	53

WATER HEATER TEMPERING VALVE

HOT WATER MADE BETTER

GREATER & SAFER HOT WATER OUTPUT PER GALLON STORED

- Allows water heater to be set at 140°F, minimizing risk of Legionella bacteria in the tank
- Mixes hot output with cold supply for greater effective hot water storage
- Adjustable temperature control limits output to 120°F to prevent risk of scalding
- Integrated recirculation port simplifies installation

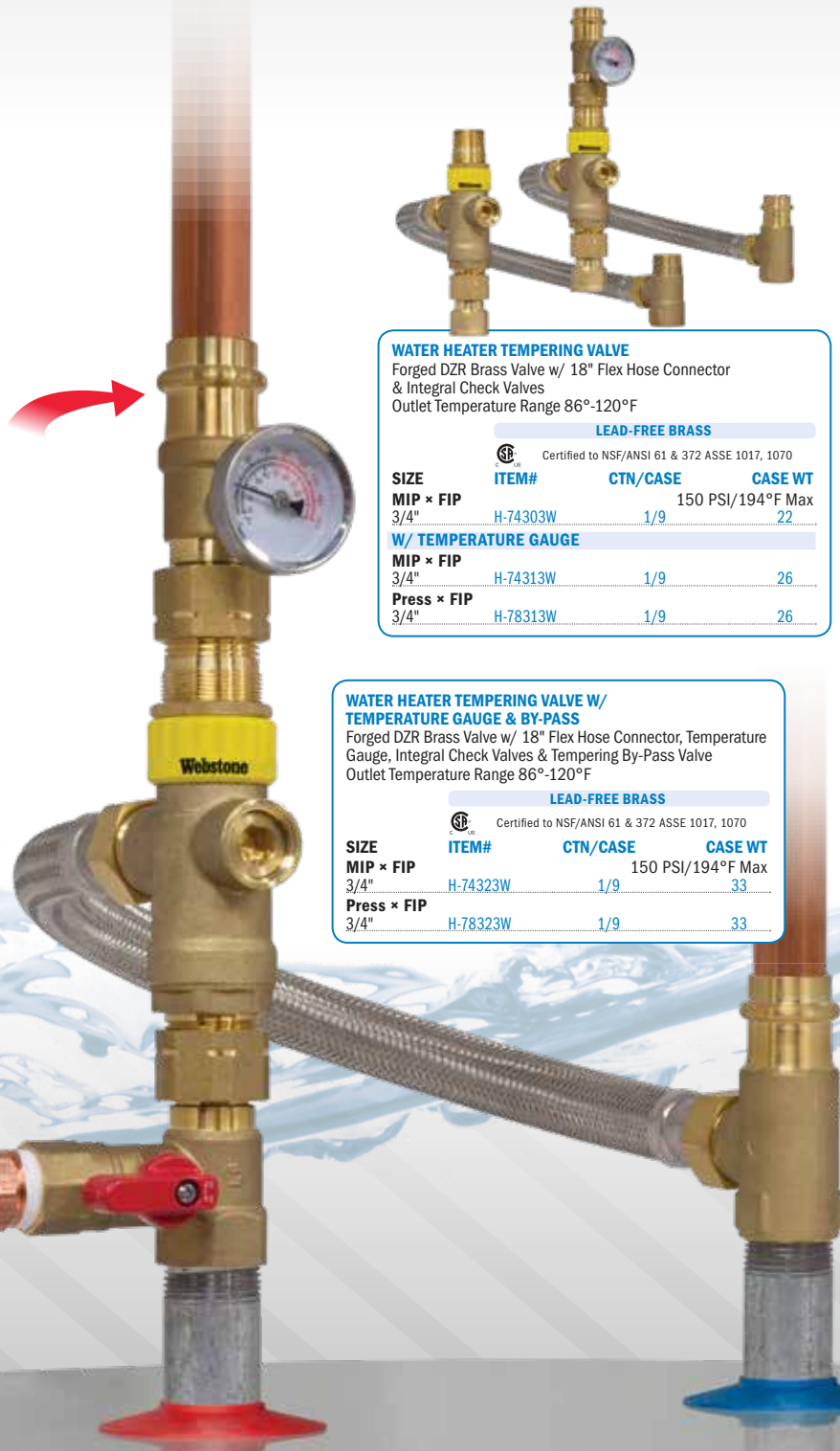

TEMPERING BY-PASS VALVE

Provides high-temp untempered water to appliances

WATER HEATER TEMPERING VALVE
Forged DZR Brass Valve w/ 18" Flex Hose Connector & Integral Check Valves
Outlet Temperature Range 86°-120°F

LEAD-FREE BRASS
Certified to NSF/ANSI 61 & 372 ASSE 1017, 1070

SIZE	ITEM#	CTN/CASE	CASE WT
MIP x FIP			150 PSI/194°F Max
3/4"	H-74303W	1/9	22
W/ TEMPERATURE GAUGE			
MIP x FIP			
3/4"	H-74313W	1/9	26
Press x FIP			
3/4"	H-78313W	1/9	26

WATER HEATER TEMPERING BY-PASS VALVE
Forged DZR Brass Valve w/ 1/2 Plugged FIP Port For Direct Connection to High-Temp Appliance

LEAD-FREE BRASS
Certified to NSF/ANSI 61 & 372

SIZE	ITEM#	CTN/CASE	CASE WT
G3/4 Union x FIP			150 PSI/194°F Max
3/4"	H-G0673W	6/48	34

WATER HEATER TEMPERING VALVE W/ TEMPERATURE GAUGE & BY-PASS
Forged DZR Brass Valve w/ 18" Flex Hose Connector, Temperature Gauge, Integral Check Valves & Tempering By-Pass Valve
Outlet Temperature Range 86°-120°F

LEAD-FREE BRASS
Certified to NSF/ANSI 61 & 372 ASSE 1017, 1070

SIZE	ITEM#	CTN/CASE	CASE WT
MIP x FIP			150 PSI/194°F Max
3/4"	H-74323W	1/9	33
Press x FIP			
3/4"	H-78323W	1/9	33

SIMPLIFY THE JOB
Tempering Valve Installation Kits include everything to connect to Copper, CPVC or PEX



WATER HEATER TEMPERING VALVE INSTALLATION KIT
Forged DZR Brass Valve w/ 18" Flex Hose Connector, Integral Check Valves & (2) 3/4" ProPush Flexible Water Heater Connectors

LEAD-FREE BRASS
Certified to NSF/ANSI 61 & 372 ASSE 1017, 1070, 1061 AMSE A112.18.6 CSA B125.6

SIZE	ITEM#	CTN/CASE	CASE WT
INCLUDES (2) 3/4" PROPUSH ITEM# H-26033W-18 FLEXIBLE WATER HEATER CONNECTORS			
3/4"	H-74303W-KITA	1/4	14
w/ Outlet Temperature Gauge			
3/4"	H-74313W-KITA	1/4	19
INCLUDES (2) 3/4" PROPUSH ITEM# H-62033W-18 FLEXIBLE WATER HEATER CONNECTORS W/ BALL VALVES			
3/4"	H-74303W-KITB	1/4	16
w/ Outlet Temperature Gauge			
3/4"	H-74313W-KITB	1/4	21

TWH SERVICE VALVES **E·X·P** S E R I E S

THE **ONLY** WAY TO INSTALL ANY **TANKLESS** **WATER HEATER**

PATENTED TECHNOLOGY

- Quicker, consistent quality installations
- Fewer leak paths
- Allows for one person diagnostic testing
- Full range of service valves styles and installation accessories
- Also for use with wall hung and combi boilers - see page 17

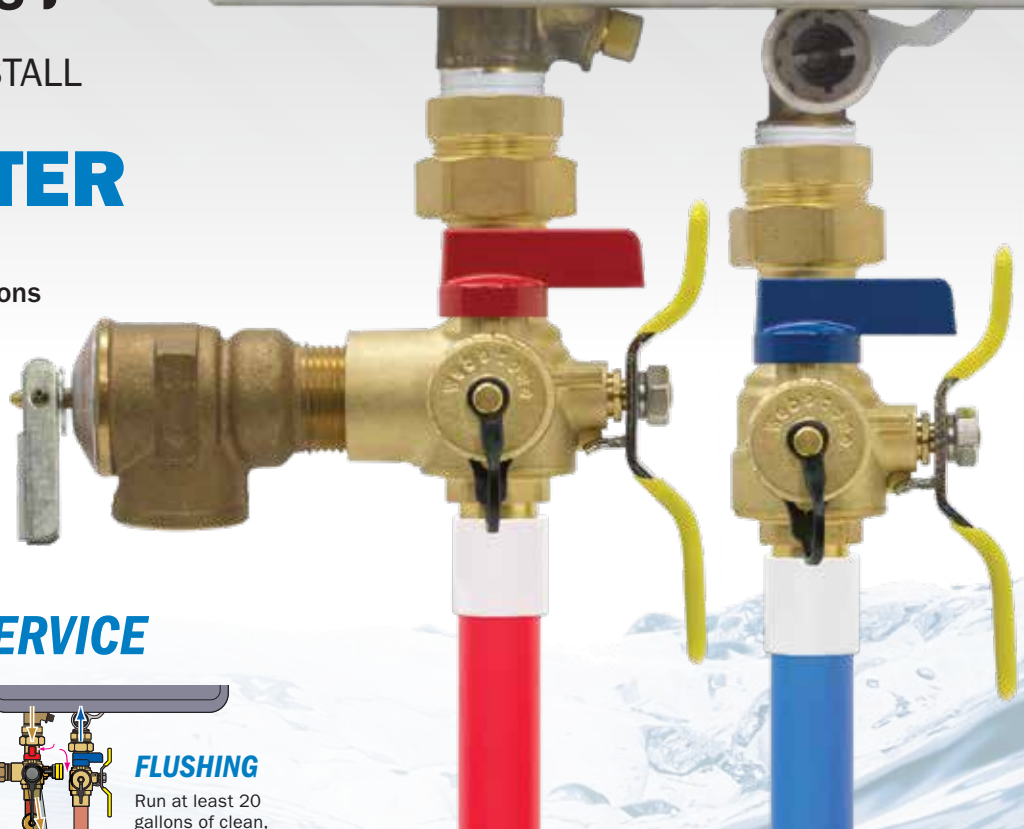

SIMPLIFIES SERVICE

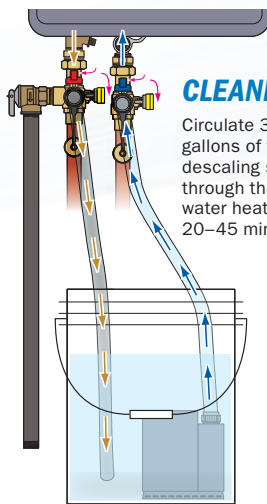

CLEANING

Circulate 3-5 gallons of flushing/descaling solution through the tankless water heater for 20-45 minutes.

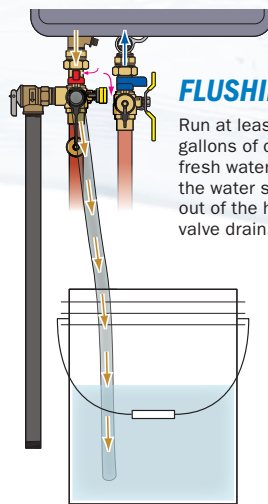

FLUSHING

Run at least 20 gallons of clean, fresh water from the water supply out of the hot valve drain.

THE OLD WAY

THE WEBSTONE WAY

REPLACES	SAVES	ELIMINATES
14	108	12
COMPONENTS	MINUTES	LEAK PATHS

NOW FOR THE NEXT GENERATION OF TANKLESS SOLUTIONS

TWH SERVICE VALVES
E·X·P E2
SPACE SAVING

No PRV port models for appliances with integrated PRV Ports.



TWH SERVICE VALVES
E·X·P
UNION BALL

For appliances with integrated PRV and drain ports

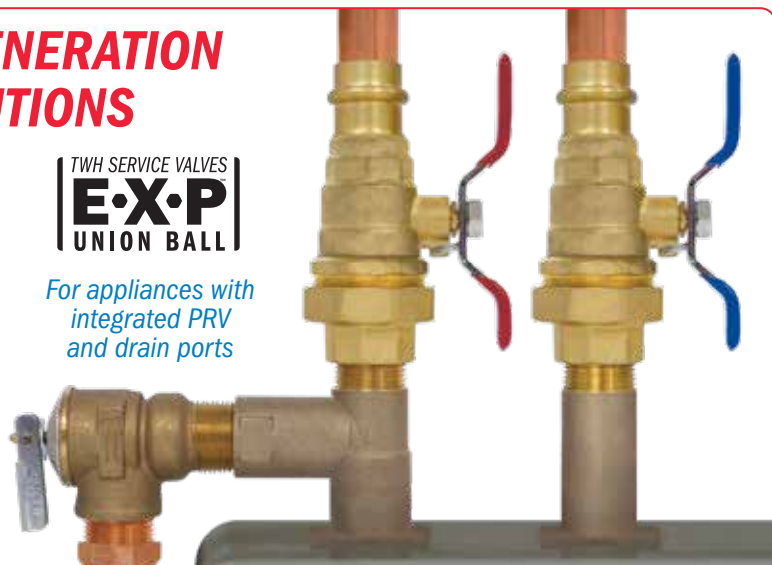

SERVICE VALVE STYLE	E-X-P		E-X-P E2		E-X-P E3		E-X-P Union Ball			
Features - all kits include Hot & Cold Set of Full Port Forged Lead-Free Brass Ball Valves and Adjustable Packing Glands										
Pressure Relief Valve (PRV) Outlet	✓	✓	✓	✓	✓	NONE	Adjustable	Adjustable	NONE	
Residential PRV (150 PSI/500,000 BTU/HR)	-	✓	-	✓	Lead-Free	-	✓	✓	-	
Hi-Flow Hose Drains	✓	✓	✓	✓	✓	✓	✓	✓	✓	
Handle Style	Wing	Wing	Wing	Wing	Wing	Wing	Wing	Lever	Wing	
Connections	Size	ITEM#	ITEM#	ITEM#	ITEM#	ITEM#	ITEM#	ITEM#	ITEM#	
FIP Union × FIP	3/4"	H-40443W	H-40443WPR	H-44443W	H-44443WPR	H-44443WPR-LF	H-44063W	H-45443WPR	H-45443WPR-LH	H-40423W-RB
	1"	-	-	H-44444W	H-44444WPR	H-44444WPR-LF	-	-	-	-
FIP Union × SWT	3/4"	H-50443W	H-50443WPR	H-54443W	H-54443WPR	H-54443WPR-LF	H-54063W	H-55443WPR	H-55443WPR-LH	H-50423W-RB
	1"	-	-	H-54444W	H-54444WPR	H-54444WPR-LF	-	-	-	-
FIP Union × Press	3/4"	-	-	H-84443W	H-84443WPR	H-84443WPR-LF	H-84063W	H-85443WPR	H-85443WPR-LH	H-80423W-RB
	1"	-	-	H-84444W	H-84444WPR	H-84444WPR-LF	-	-	-	-
FIP Union × Push	3/4"	-	-	H-64443W	H-64443WPR	-	H-64063W	-	-	-
FIP Union × ASTM F1960 PEX	3/4"	-	-	H-34443W	H-34443WPR	-	H-34063W	-	-	H-30423W-RB
FIP Union × ASTM F1807 PEX	3/4"	-	-	H-14443W	H-14443WPR	-	H-14063W	-	-	H-10423W-RB

TWH SERVICE VALVES
E-X-P
PREMIUM DESIGN

PREMIUM DESIGN



E-X-P TANKLESS WATER HEATER SERVICE VALVE KIT

Hot & Cold Set of Full Port Forged Brass Ball Valves w/ Hi-Flow Hose Drains, Pressure Relief Valve Outlet & Adjustable Packing Glands

LEAD-FREE BRASS

Certified to NSF/ANSI 61 & 372

SIZE	ITEM#	CTN/CASE	CASE WT
FIP Union × FIP			600 PSI CWP Max
3/4"	H-40443W	1/8	40
FIP Union × SWT			600 PSI CWP Max
3/4"	H-50443W	1/8	38
W/ RESIDENTIAL PRESSURE RELIEF VALVE			
FIP Union × FIP			600 PSI CWP Max
3/4"	H-40443WPR	1/8	51
FIP Union × SWT			600 PSI CWP Max
3/4"	H-50443WPR	1/8	51

TWH SERVICE VALVES
E-X-P E2
SPACE SAVING

SPACE SAVING



E-X-P E2 TANKLESS WATER HEATER SERVICE VALVE KIT

Hot & Cold Set of Full Port Forged DZR Brass Ball Valves w/ Hi-Flow Hose Drains & Adjustable Packing Glands

LEAD-FREE BRASS

Certified to NSF/ANSI 61 & 372

SIZE	ITEM#	CTN/CASE	CASE WT
FIP Union × FIP			500 PSI CWP Max/200°F Max
3/4"	H-44063W	1/10	34
FIP Union × SWT			500 PSI CWP Max/200°F Max
3/4"	H-54063W	1/10	35
FIP Union × Press			250 PSI CWP Max/200°F Max
3/4"	H-84063W	1/10	36
FIP Union × Push			200 PSI CWP Max/200°F Max
3/4"	H-64063W*	1/10	36
FIP Union × ASTM F1960 PEX			400 PSI CWP Max/200°F Max
3/4"	H-34063W*	1/10	34
FIP Union × ASTM F1807 PEX			400 PSI CWP Max/200°F Max
3/4"	H-14063W*	1/10	33

W/ PRESSURE RELIEF VALVE OUTLET

FIP Union × FIP			500 PSI CWP Max
3/4"	H-44443W	1/10	31
1"	H-44444W	1/10	54
FIP Union × SWT			500 PSI CWP Max
3/4"	H-54443W	1/10	32
1"	H-54444W	1/10	54
FIP Union × Press			250 PSI CWP Max/250°F Max
3/4"	H-84443W	1/10	32
1"	H-84444W	1/10	56
FIP Union × Push			200 PSI CWP Max
3/4"	H-64443W*	1/10	32

FIP Union × ASTM F1960 PEX			400 PSI CWP Max
3/4"	H-34443W*	1/10	34
FIP Union × ASTM F1807 PEX			400 PSI CWP Max
3/4"	H-14443W*	1/10	33

W/ RESIDENTIAL PRESSURE RELIEF VALVE

FIP Union × FIP			500 PSI CWP Max/210°F Max
3/4"	H-44443WPR	1/10	37
1"	H-44444WPR	1/10	65
FIP Union × SWT			500 PSI CWP Max/210°F Max
3/4"	H-54443WPR	1/10	42
1"	H-54444WPR	1/10	65
FIP Union × Press			250 PSI CWP Max/250°F Max
3/4"	H-84443WPR	1/10	36
1"	H-84444WPR	1/10	65

FIP Union × Push			200 PSI/200°F Max
3/4"	H-64443WPR*	1/10	36
FIP Union × ASTM F1960 PEX			400 PSI CWP Max
3/4"	H-34443WPR*	1/10	38
FIP Union × ASTM F1807 PEX			400 PSI CWP Max
3/4"	H-14443WPR*	1/10	38

W/ LEAD-FREE RESIDENTIAL PRESSURE RELIEF VALVE

FIP Union × FIP			500 PSI CWP Max
3/4"	H-44443WPR-LF	1/10	37
1"	H-44444WPR-LF	1/10	65
FIP Union × SWT			500 PSI CWP Max
3/4"	H-54443WPR-LF	1/10	42
1"	H-54444WPR-LF	1/10	65
FIP Union × Press			250 PSI CWP Max/250°F Max
3/4"	H-84443WPR-LF	1/10	36
1"	H-84444WPR-LF	1/10	65

*SERVICE VALVES ALSO CERTIFIED TO NSF/ANSI 14, ASSE 1061

†SERVICE VALVES ALSO CERTIFIED TO NSF/ANSI 14

E-X-P E3 TANKLESS WATER HEATER SERVICE VALVE KIT

Hot & Cold Set of Full Port Forged Brass Ball Valves w/ Hi-Flow Hose Drains, Adjustable Pressure Relief Valve Outlet & Adjustable Packing Glands - Includes Residential Pressure Relief Valve

LEAD-FREE BRASS

Certified to NSF/ANSI 61 & 372

SIZE	ITEM#	CTN/CASE	CASE WT
FIP Union × FIP			500 PSI CWP Max
3/4"	H-45443WPR	1/10	48
FIP Union × SWT			500 PSI CWP Max
3/4"	H-55443WPR	1/10	45
FIP Union × Press			250 PSI CWP Max/250°F Max
3/4"	H-85443WPR	1/10	48
W/ LEVER HANDLES			
FIP Union × FIP			500 PSI CWP Max
3/4"	H-45443WPR-LH	1/10	48
FIP Union × SWT			500 PSI CWP Max
3/4"	H-55443WPR-LH	1/10	48
FIP Union × Press			250 PSI CWP Max
3/4"	H-85443WPR-LH	1/10	48

TWH SERVICE VALVES
E-X-P E3
ADJUSTABLE PRV PORT

RECESSED BOXES



PR-LH Kits include lever handles for tight combi boiler installations

TWH SERVICE VALVES
E-X-P
UNION BALL

For appliances with integrated PRV & drain ports



Also perfect for traditional tanked water heater connections

E-X-P UNION BALL TANKLESS WATER HEATER SERVICE VALVE KIT

Hot & Cold Set of Full Port Forged DZR Brass Ball Valves w/ Union Ends & Adjustable Packing Glands,

LEAD-FREE BRASS

Certified to NSF/ANSI 61 & 372

SIZE	ITEM#	CTN/CASE	CASE WT
FIP Union × FIP			250 PSI CWP Max/200°F Max
3/4"	H-40423W-RB	1/12	31
FIP Union × SWT			250 PSI CWP Max/200°F Max
3/4"	H-50423W-RB	1/12	30
FIP Union × Press			250 PSI CWP Max/200°F Max
3/4"	H-80423W-RB	1/12	32
FIP Union × ASTM F1960 PEX			250 PSI CWP Max/200°F Max
3/4"	H-30423W-RB*	1/12	30
FIP Union × ASTM F1807 PEX			250 PSI CWP Max/200°F Max
3/4"	H-10423W-RB*	1/12	30

*ALSO CERTIFIED TO NSF/ANSI 14

PRESSURE RELIEF VALVE OPTIONS

See next page for a full selection of installation accessories



RESIDENTIAL PRV 150 PSI/500,000 BTU/HR
PR Kits: Standard Brass
PR-LF Kits: Lead-Free Brass

BOILER PRV 30 PSI/510,000 BTU/HR for Boiler/Hydronic Applications
(see page 17)

TWH SERVICE VALVES
E·X·P
COMPLETE

COM KIT
3/4" CGA
Gas Ball Valve
(175 WOG)

COM-FP KIT
3/4" CSA Full Port
Forged Brass Ball
Valve (600 WOG)



E-X-P COMPLETE TANKLESS WATER HEATER INSTALLATION KIT
Includes E-X-P E2 Service Valves w/ Residential Pressure Relief Valve (150 PSI/500,000 BTU/HR), 24" x 3/4" Gas Flex Line, & Choice of Gas Ball Valve

LEAD-FREE BRASS

Certified to NSF/ANSI 61 & 372

SIZE	COM KIT	COM-FP KIT	CTN/CASE	CASE WT
FIP Union x FIP				500 PSI CWP Max/210°F Max
3/4"	H-44443WCOM	H-44443WCOM-FP	1/4	29
FIP Union x SWT				500 PSI CWP Max/210°F Max
3/4"	H-54443WCOM	H-54443WCOM-FP	1/4	30

E-X-P ACCESSORIES

Add an Installation Kit to the E-X-P of your choice, or customize your installation with individual accessories.



TANKLESS WATER HEATER INSTALLATION KIT
3/4" CGA Gas Ball Valve (175 WOG) & 24" x 3/4" Gas Flex Line

SIZE	ITEM#	CTN/CASE	CASE WT
FIP			
3/4"	H-22563-24	1/10	20
W/ LEAD-FREE PRESSURE RELIEF VALVE RELOCATION ADAPTER (FOR USE WITH E-X-P E2)			
3/4"	H-22563-24-ADPT	1/10	26



TANKLESS WATER HEATER INSTALLATION KIT
3/4" CSA Full Port Forged Brass Ball Valve (600 WOG) & 24" x 3/4" Gas Flex Line

SIZE	ITEM#	CTN/CASE	CASE WT
FIP			
3/4"	H-41703T-24	1/10	21
W/ LEAD-FREE PRESSURE RELIEF VALVE RELOCATION ADAPTER (FOR USE WITH E-X-P E2)			
3/4"	H-41703T-24-ADPT	1/10	27



PRESSURE RELIEF VALVES

STANDARD BRASS

SIZE	ITEM#	CTN/CASE	CASE WT
RESIDENTIAL PRESSURE RELIEF VALVE 150 PSI/500,000 BTU/HR			
3/4"	H-20713*	1/100	46
COMMERCIAL GRADE PRESSURE RELIEF VALVE & CLOSE NIPPLE 150 PSI/2.7M BTU			
3/4"	H-20723-CN†	1/10	15
BOILER PRESSURE RELIEF VALVE 30 PSI/510,000 BTU/HR			
3/4"	H-20733‡	1/100	46

LEAD-FREE BRASS

SIZE	ITEM#	CTN/CASE	CASE WT
RESIDENTIAL PRESSURE RELIEF VALVE 150 PSI/500,000 BTU/HR			
3/4"	H-20713W*	1/100	46

CERTIFICATION APPLIES TO CASH ACME *FWL-2, †F-82, ‡F-30



E-X-P PRESSURE RELIEF VALVE RELOCATION ADAPTER

For Recessed Boxes, Tight or Unique Installations

LEAD-FREE BRASS

Certified to NSF/ANSI 61 & 372

SIZE	ITEM#	CTN/CASE	CASE WT
Fits E-X-P E2			
3/4"	H-28023W	10/100	58



ADD-A-GAUGE

TO ANY STANDARD HOSE CONNECTION IN JUST MINUTES

PATENTED TECHNOLOGY

- Utilize any hose connection as a gauge port
- Suitable for temporary or permanent gauge installation
- Works with temperature and/or pressure gauges



ADD-A-GAUGE TOOL

Forged Brass Hose Fitting

LEAD-FREE BRASS

SIZE	ITEM#	CTN/CASE	CASE WT
W/ 1/8" BLEEDER (CAPPED) FOR CONNECTION TO PRESSURE GAUGE			
Hose x FIP Union			
3/4" x 1/4"	H-3000W-P	10/100	27
W/ 1/8" BLEEDER (CAPPED) FOR CONNECTION TO TEMPERATURE/PRESSURE GAUGE			
Hose x FIP Union			
3/4" x 1/2"	H-3000W-TP	10/100	27

UNDER BOILER SOLUTIONS

A **SINGLE SOURCE** FOR BETTER **INSTALLATIONS**

- Saves time, space, and labor
- Maintains system efficiency
- Simplifies future maintenance
- Full-featured installations require no more than 22"
- Innovative solutions available for external pumps and combi DHW connections
- G1 union accessories for unique installation needs- see page 19

AIR SEPARATOR

Reduces noise and improves system operation - SEE PAGE 20

MAGNETIC BOILER FILTER

High-powered magnet captures ferrous debris - SEE PAGE 18

HYDRO-CORE MANIFOLD

Avoids precise calculations and costly field fabrication - SEE PAGE 15

DIFFERENTIAL PRESSURE BY-PASS VALVE

Eliminates noise in a zoned hydronic system with fixed-speed primary circulator pump - SEE PAGE 19

PATENTED TECHNOLOGY



HYDRO-CORE™

PATENTED TECHNOLOGY

THE **CORE** OF ANY PROFESSIONAL **HYDRONIC** INSTALLATION

The Webstone Hydro-Core Manifold is the ideal solution for most near boiler piping or secondary loops.

- Combines Webstone Isolator® and Ball Drain™ with closely spaced tees
- Eliminates costly field fabrication
- Avoids precise calculations
- Simplifies future maintenance
- Saves space
- All with EXPERT looking results

HYDRO-CORE UNION CONNECTION

Available in three distinct styles to meet your needs
SEE PAGE 17



PRO-CONNECT PRESS

Compatible with popular press tools

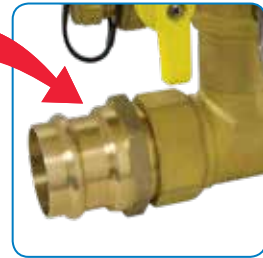

THE OLD WAY

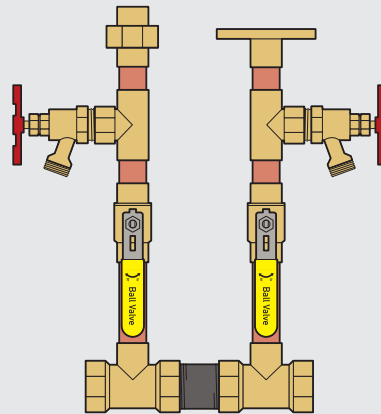

THE WEBSTONE WAY

REPLACES	SAVES	ELIMINATES
17	144	16
COMPONENTS	MINUTES	LEAK PATHS



T-Flow Ball
Directs flow into either the boiler or purge drain

Precision-Crafted Closely Spaced Tees
for hydraulic separation

Fully-Insulated Body **Snug-Fit Rotating Flange**



FLANGE OPTIONS



Flange Right



Flange Left



No Flange
Double Ball Drain

ADVANTAGES

PRECISE SPACING FOR HYDRAULIC SEPARATION

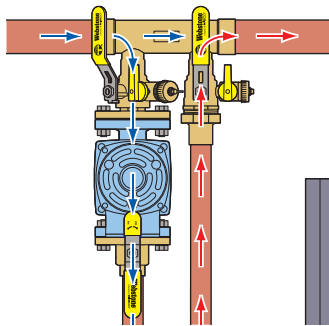

SIMPLIFIES PUMP ISOLATION

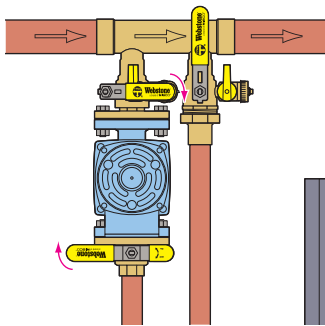

EASILY PURGE, FILL, OR DESCALE* A BOILER OR SECONDARY LOOP

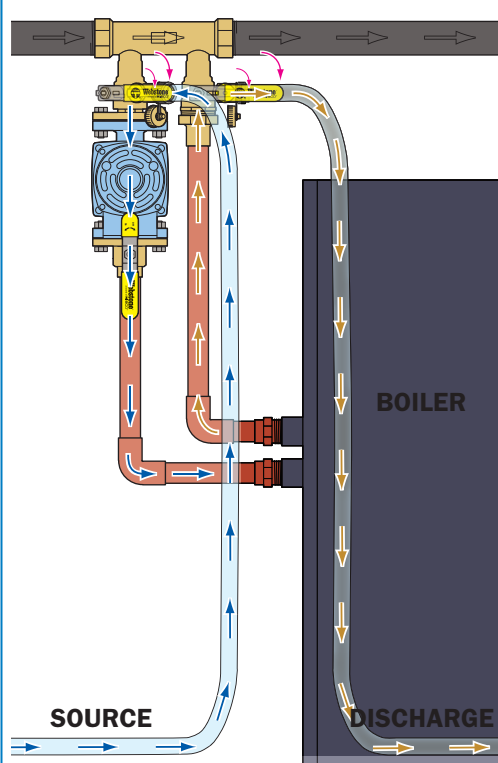

*DESCALING MAY NOT BE RECOMMENDED FOR ALL BOILERS. CONSULT BOILER MANUFACTURER FOR DETAILS.

SIMPLIFIES SYSTEM PURGING THROUGH THE BOILER OUTSIDE THE BOILER

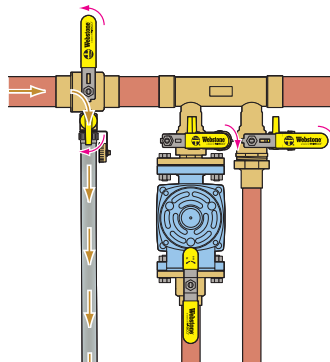
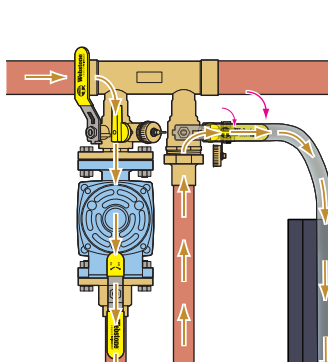

HYDRO-CORE MANIFOLD KITS

Kits include Hydro-Core Manifold and Union Connections. Ideal for field-fabricated near boiler piping or secondary loops.

PUMP LOCATION		Manifold Flange Orientation	System Run	Boiler Connection	FIP	SWT	Press * FIP
Floor Standing Boilers	Wall Hung Boilers						
Internal to boiler	Internal to boiler	Double Ball Drain	1 1/4"	3/4"	H-48354-43	H-58354-53	H-88354-43
			1 1/4"	1"	H-48354-44	H-58354-54	H-88354-44
On the system return line, to the left of system supply line	On the system return line, to the right of system supply line	Flange Right	1 1/4"	3/4"	H-48754-43	H-58754-53	H-88754-43
			1 1/4"	1"	H-48754-44	H-58754-54	H-88754-44
On the system return line, to the right of system supply line	On the system return line, to the left of system supply line	Flange Left	1 1/2"	1 1/4"	H-48765-45	H-58765-55	H-88765-45
			1 1/4"	3/4"	H-48854-43	H-58854-53	H-88854-43
			1 1/4"	1"	H-48854-44	H-58854-54	H-88854-44
			1 1/2"	1 1/4"	H-48865-45	H-58865-55	H-88865-45

FLOOR STANDING BOILERS

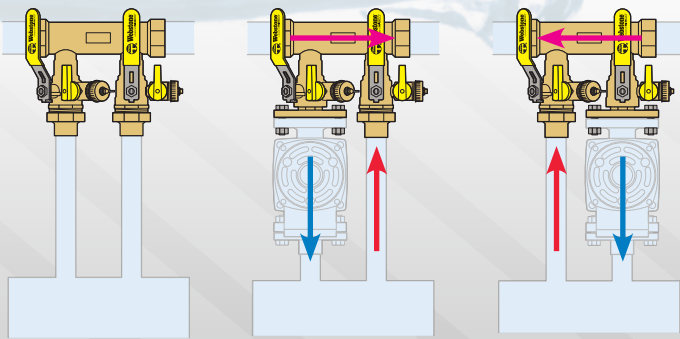

PUMP INTERNAL TO BOILER
Double Ball Drain Manifold

PUMP TO LEFT OF SUPPLY LINE
Flange Right Manifold

PUMP TO RIGHT OF SUPPLY LINE
Flange Left Manifold

WALL HUNG BOILERS

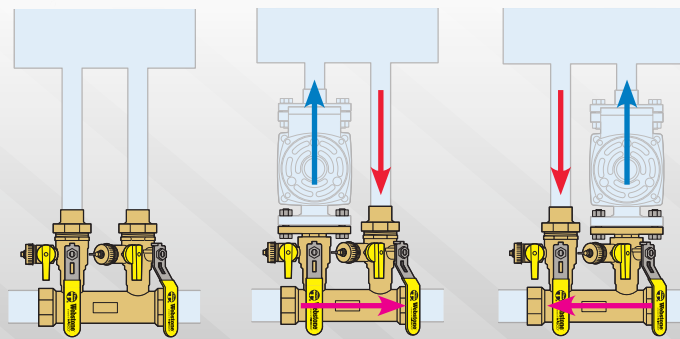

PUMP INTERNAL TO BOILER
Double Ball Drain Manifold

PUMP TO LEFT OF SUPPLY LINE
Flange Left Manifold

PUMP TO RIGHT OF SUPPLY LINE
Flange Right Manifold

BOILER COMPATIBILITY ASSUMPTIONS:

- Hydro-Core manifolds will be selected in accordance with the manufacturers' recommended run, supply and return sizes.
- Selected heat flow direction is acceptable for the installation.
- Customers will ensure that their installation can accommodate any other devices noted by the boiler manufacturer.
- External pumps will be mounted to the manifold and connected to the boiler return.

IF AN EXTERNAL PUMP IS REQUIRED, THE MANIFOLD WILL BE INSTALLED AS FOLLOWS:

- Ports below the boiler: manifold is installed below with the pump mounted in between.
- Ports on the top or side of the boiler: manifold is installed above the boiler with the pump mounted in between.
- Contact Webstone if your installation varies from these conditions.

HYDRO-CORE™

COMPLETE NEAR BOILER PIPING KITS

A fully-fabricated solution, kits include everything necessary for a successful installation.

REPLACES **34** COMPONENTS
 SAVES **261** MINUTES
 ELIMINATES **29** LEAK PATHS
(savings vary by boiler)

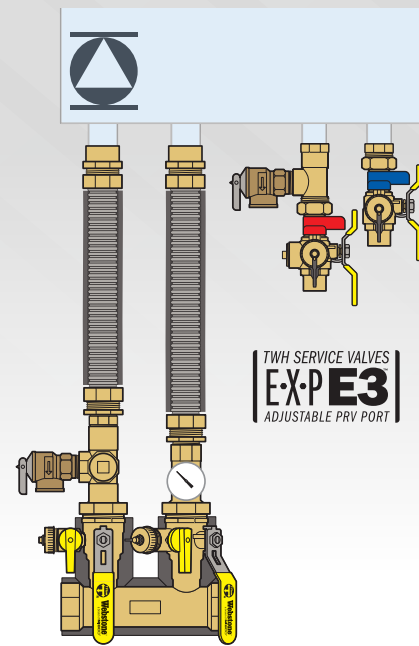
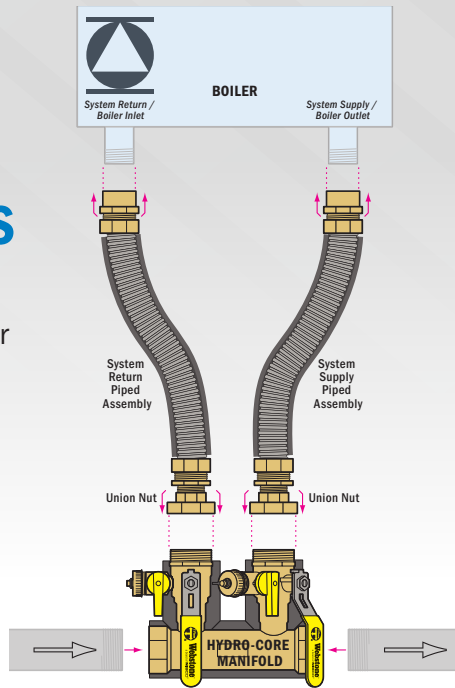

COMBI BOILER KITS†

Includes all the features of the wall hung boiler kits, plus components for DHW connections

WALL HUNG BOILER KITS†

- Choice of **Press**, FIP or SWT Hydro-Core Double Ball Drain Manifold
- Insulated manifold, supply & return lines
- Integrated connections for your specific boiler
- Assembled with flexible stainless steel tubing
- Tubing may be cut for installations in close quarters

- Plugged FIP ports for connection to other devices
- 1/4" pressure gauge port
- 30 psi pressure gauge
- 30 psi pressure relief valve for boiler
- 3/4" E-X-P E3 service valve kit
- 150 psi pressure relief valve for DHW

† Features vary by kit.

NOW AVAILABLE FOR



Boiler	BOSCH		BURNHAM	LAARS	LOCHINVAR		NAVIEN	PEERLESS	WEIL-MCLAIN		WILLIAMSON-THERMOFLO		
MODEL	GreenStar 57 (ZBR16-3) 79 (ZBR21-3) 100 (ZBR28-3) 131 (ZBR35-3) 151 (ZBR42-3) GreenStar Combi 100 (ZWB28-3) 131 (ZWB35-3) 151 (ZWB42-3)		K2 Combi K2WTC-135 K2WTC-150 K2WTC-180	Mascot FT Combi MFTCW 140 MFTCW 199	Noble NKB080 NKB110 NKB150 NKB199 Epic EPB080 EPB110 EPB150 EPB199	Noble Fire Tube Combi NKC110N NKC150N NKC199N	NCB-180 NCB-210 NCB-240	PBC 34 40 52		AquaBalance Series 1 WMB-80C WMB-120C	AquaBalance Series 1 WMB-155	Freestyle Combi FS-80 FS-120	Freestyle FS-155
Compatible Complete Near Boiler Piping Kits	SYSTEM PIPING	ITEM#	ITEM#	ITEM#	ITEM#	ITEM#	ITEM#	ITEM#	ITEM#	ITEM#	ITEM#	ITEM#	ITEM#
FIP	H-4FK4-WIF	H-4FK5-CH	H-4FK5-CH	H-4CC4-NBHK-E3	H-4CC4-NBHK-E3	H-4FK5-CH	H-4CC4-NBHK-E3	H-4FK4R3-WIF-E3	H-4FK4R3-WIF-E3	H-4FK4-WIF	H-4FK4R3-WIF-E3	H-4FK4-WIF	
SWT	H-5FK4-WIF	H-5FK5-CH	H-5FK5-CH	H-5CC4-NBHK-E3	H-5CC4-NBHK-E3	H-5FK5-CH	H-5CC4-NBHK-E3	H-5FK4R3-WIF-E3	H-5FK4R3-WIF-E3	H-5FK4-WIF	H-5FK4R3-WIF-E3	H-5FK4-WIF	
PRESS	H-8FK4-WIF	H-8FK5-CH	H-8FK5-CH	H-8CC4-NBHK-E3	H-8CC4-NBHK-E3	H-8FK5-CH	H-8CC4-NBHK-E3	H-8FK4R3-WIF-E3	H-8FK4R3-WIF-E3	H-8FK4-WIF	H-8FK4R3-WIF-E3	H-8FK4-WIF	
Kit Features													
SYSTEM RUN	1 1/4"	1 1/4"	1 1/4"	1 1/4"	1 1/4"	1 1/4"	1 1/4"	1 1/4"	1 1/4"	1 1/4"	1 1/4"	1 1/4"	
BOILER CONNECTION	1"	1"	1"	1"	1"	1"	1"	3/4"	3/4"	1"	3/4"	1"	
MANIFOLD TYPE	Double Ball Drain	Double Ball Drain	Double Ball Drain	Flange Left	Double Ball Drain	Double Ball Drain	Double Ball Drain	Double Ball Drain	Double Ball Drain	Double Ball Drain	Double Ball Drain	Double Ball Drain	
SUPPLY & RETURN PIPING	Flexible Stainless Steel	Flexible Stainless Steel	Flexible Stainless Steel	Bent Copper	Bent Copper	Flexible Stainless Steel	Bent Copper	Flexible Stainless Steel	Flexible Stainless Steel	Flexible Stainless Steel	Flexible Stainless Steel	Flexible Stainless Steel	
FULLY INSULATED	✓	✓	✓	✓	✓	✓	✓	✓	✓	✓	✓	✓	
1/4" NPT GAUGE PORT	-	✓	✓	✓	-	✓	-	-	-	-	-	-	
PRESSURE GAUGE	-	✓	✓	✓	-	✓	-	-	-	-	-	-	
3/4" FIP DEVICE PORTS	-	✓	✓	✓	-	✓	-	✓	✓	-	✓	-	
MESH "Y" STRAINER	-	✓	✓	✓	-	✓	-	-	-	-	-	-	
30 PSI BOILER PRV	-	✓	✓	✓	-	✓	-	-	-	-	-	-	
COMBI BOILER DOMESTIC HOT WATER SERVICE VALVE KIT	-	3/4" E-X-P E3	3/4" E-X-P E3	-	3/4" E-X-P E3 with Lever Handles†	3/4" E-X-P E3	3/4" E-X-P E3 with Lever Handles†	3/4" E-X-P E3	3/4" E-X-P E3	-	3/4" E-X-P E3	-	
150 PSI DHW PRV	-	Lead-Free	Lead-Free	-	✓	Lead-Free	✓	-	-	-	-	-	

* All manufacturer names, models and part numbers are trademarked or registered trademark property of their respective owners. Webstone products are not manufactured, sponsored, authorized, or endorsed by any party unless otherwise noted.

† Also available without Combi DHW service valves - Item# H-4CC4-NBHK (FIP), H-5CC4-NBHK (SWT), H-8CC4-NBHK (Press)

HYDRO-CORE™

ACCESSORIES

Join mixed piping types, add a gauge, connect devices, connect a pump, or add a strainer to your Hydro-Core installation.

Manifold / Union Connection Compatibility			
UNION CONNECTION SIZE	FIP MANIFOLD KIT	SWT MANIFOLD KIT	PRESS MANIFOLD KIT
1"	H-48354-43	H-58354-53	H-88354-43
1"	H-48354-44	H-58354-54	H-88354-44
1"	H-48754-43	H-58754-53	H-88754-43
1"	H-48754-44	H-58754-54	H-88754-44
1 1/4"	H-48765-45	H-58765-55	H-88765-45
1"	H-48854-43	H-58854-53	H-88854-43
1"	H-48854-44	H-58854-54	H-88854-44
1 1/4"	H-48865-45	H-58865-55	H-88865-45

PUMP CONNECTION

SIZE	ITEM#	STANDARD BRASS CTN/CASE	CASE WT
ROTATING FLANGE			
SWT × Rotating Flange 600 PSI CWP Max			
1"	H-RF4-54	6/24	25
1 1/4"	H-RF5-55	6/24	23
ROTATING FLANGE W/ "Y" STRAINER			
SWT × Rotating Flange 600 PSI CWP Max			
1"	H-FSTR4-54	6/24	39
1 1/4"	H-FSTR5-55	6/24	47



STAINLESS STEEL LIQUID FILLED DUAL SCALE PRESSURE GAUGE

2" Dial w/ Center Back Connection

SIZE	ITEM#	CTN/CASE	CASE WT
MIP			30 PSI
1/4"	H-31000	1/100	38

HYDRO-CORE UNION CONNECTION

STANDARD BRASS			
SIZE	ITEM#	CTN/CASE	CASE WT
1" UNION CONNECTION			
FIP 600 PSI CWP Max			
3/4"	H-HCE4-43	6/24	14
1"	H-HCE4-44	6/24	11
SWT 600 PSI CWP Max			
3/4"	H-HCE4-53	6/24	12
1"	H-HCE4-54	6/24	12
1 1/4" UNION CONNECTION			
FIP 600 PSI CWP Max			
1"	H-HCE5-44	6/24	20
1 1/4"	H-HCE5-45	6/24	16
SWT 600 PSI CWP Max			
1"	H-HCE5-54	6/24	17
1 1/4"	H-HCE5-55	6/24	18



HYDRO-CORE UNION CONNECTION

w/ 1/4" NPT Gauge Port (Plugged)

STANDARD BRASS			
SIZE	ITEM#	CTN/CASE	CASE WT
1" UNION CONNECTION			
FIP 600 PSI CWP Max			
3/4"	H-HCE4-63	6/24	25
1"	H-HCE4-64	6/24	22
SWT 600 PSI CWP Max			
3/4"	H-HCE4-73	6/24	19
1"	H-HCE4-74	6/24	19
1 1/4" UNION CONNECTION			
FIP 600 PSI CWP Max			
1"	H-HCE5-64	6/24	37
1 1/4"	H-HCE5-65	6/24	38
SWT 600 PSI CWP Max			
1"	H-HCE5-74	6/24	27
1 1/4"	H-HCE5-75	6/24	27



HYDRO-CORE UNION CONNECTION W/ MULTIPLE DEVICE PORTS

Plugged Connections for (2) 3/4" Devices or (1) 3/4" Device & (1) 1/4" Pressure Gauge

STANDARD BRASS			
SIZE	ITEM#	CTN/CASE	CASE WT
1" UNION CONNECTION			
SWT 600 PSI CWP Max			
1"	H-HCE4-94	6/24	27



BOILER SERVICE VALVES

E·X·P™

S E R I E S

WALL HUNG & COMBI BOILER INSTALLATIONS

Save space, simplify maintenance, and eliminate leak paths utilizing an E-X-P kit for wall hung or combi boiler hydronic heat connections.

WALL HUNG & COMBI BOILER SERVICE VALVE KIT

Hot & Cold Set of Full Port Forged Brass Ball Valves w/ Hi-Flow Hose Drains, Pressure Relief Valve Outlet & Adjustable Packing Glands

STANDARD BRASS				
SIZE	ITEM#	PR3 ITEM#	CTN/CASE	CASE WT
FIP Union × FIP 500 PSI CWP Max				
1"	H-44444	H-44444PR3	1/10	54
LEAD-FREE BRASS				
Certified to NSF/ANSI 61 & 372				
FIP Union × FIP 500 PSI CWP Max				
1"	H-44444W	H-44444WPR3	1/10	54
FIP Union × SWT 500 PSI CWP Max				
1"	H-54444W	H-54444WPR3	1/10	54
FIP Union × Press 250 PSI CWP Max/250°F Max				
1"	H-84444W	H-84444WPR3	1/10	56

PR3 KITS
Includes 30 PSI/510,000 BTU/HR Pressure Relief Valve for Boiler/Hydronic Applications

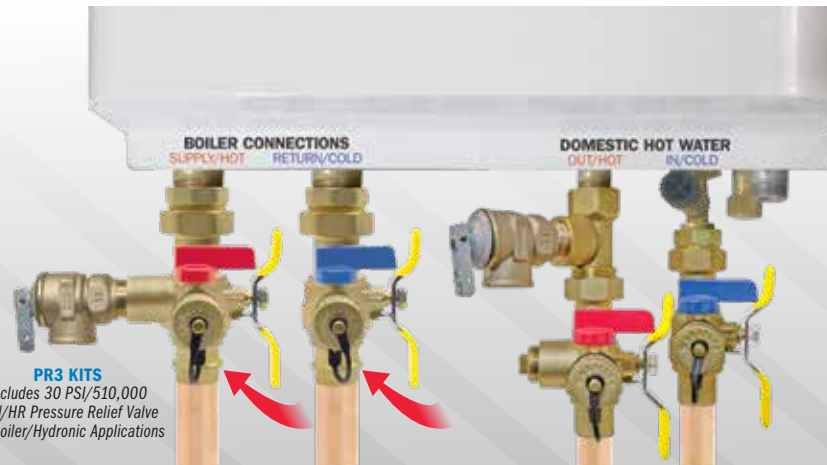

E-X-P TANKLESS WATER HEATER KITS ARE IDEAL FOR COMBI BOILER DHW CONNECTIONS - [SEE PAGE 10](#)

MAGNETIC BOILER FILTER

THE **POWERFUL** WAY
TO STAY **EFFICIENT**

- High-powered 12,000 Gauss magnet captures ferrous debris
- Universal diverter allows use with any piping orientation
- G1 Union connections with or without available isolation valves
- Protects system components
- Maintains system efficiency
- Wide range of G1 Union Accessories offer a solution for most installation needs - see page 19



MAGNETIC BOILER FILTER

12,000 Gauss Magnet, Diverter & G1 Union Connections, Integrated Hose Drain Valve, Air Vent & Filter (Includes Service Tool)

STANDARD BRASS			
SIZE	ITEM#	CTN / CASE	CASE WT
FIP 175 PSI CWP Max/250°F Max			
3/4"	H-72703	1/4	11
1"	H-72704	1/4	11
MIP			
3/4"	H-74703	1/4	11
1"	H-74704	1/4	11
SWT			
3/4"	H-75703	1/4	11
1"	H-75704	1/4	11
Press			
3/4"	H-78703	1/4	11
1"	H-78704	1/4	11
W/ (2) G1 ISOLATION VALVES			
FIP 175 PSI CWP Max/250°F Max			
3/4"	H-72713	1/4	11
1"	H-72714	1/4	11
MIP			
3/4"	H-74713	1/4	11
1"	H-74714	1/4	11
SWT			
3/4"	H-75713	1/4	11
1"	H-75714	1/4	11
Press			
3/4"	H-78713	1/4	11
1"	H-78714	1/4	11
BODY ONLY - INSTALL W/ (2) G1 UNION FITTINGS			
G1 Thread			
1"	H-70700	1/4	11



Install on boiler inlet/system return line for maximum boiler protection

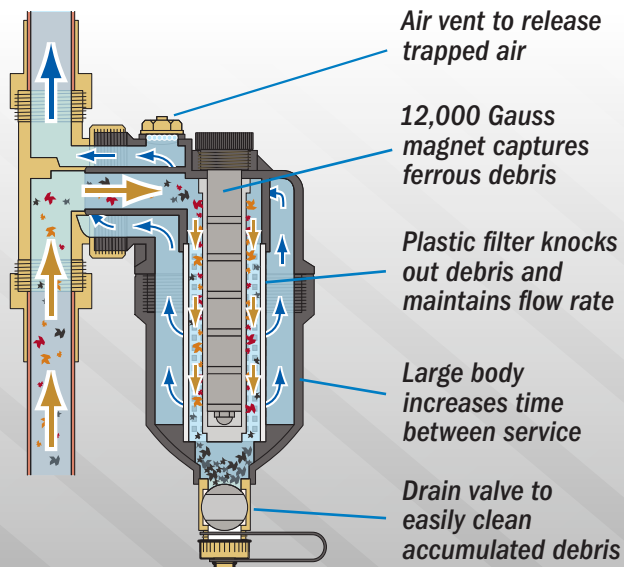
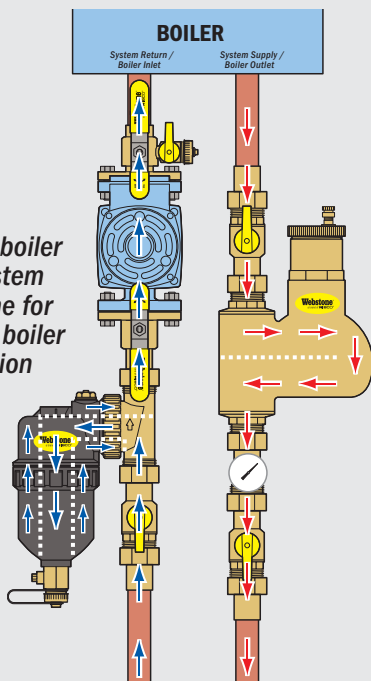

DIFFERENTIAL PRESSURE BY-PASS VALVE



FORGED BRASS DIFFERENTIAL PRESSURE BY-PASS VALVE

Opening Differential Pressure Setting
Adjustable from 1.5 to 9 PSI

STANDARD BRASS				
SIZE	MAX GPM	ITEM#	CTN/CASE	CASE WT
FIP 145 PSI CWP Max/230°F Max				
3/4"	9	H-74533	1/36	25
1"	18	H-74544	1/36	31
MIP				
3/4"	9	H-72533	1/36	25
1"	18	H-72544	1/36	31
SWT				
3/4"	9	H-75533	1/36	25
1"	18	H-75544	1/36	31
Press				
3/4"	9	H-78533	1/36	25
1"	18	H-78544	1/36	31
BODY ONLY - INSTALL W/(2) G1 UNION FITTINGS				
G1 Thread				
3/4"	9	H-70530	1/36	25
1"	18	H-70540	1/36	31

THE **QUIET** WAY TO ZONE **FIXED-SPEED** SYSTEMS

- Eliminates noise in a zoned hydronic system with fixed-speed primary circulator pump
- Protects system components
- Maintains system efficiency
- Prevents over-pumping of zones
- Installs between the boiler supply and return lines, or between zone legs in larger systems
- Installs in any orientation
- Customize with G1 Union Accessories - see below

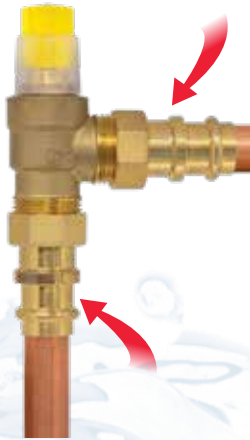

FORGED BRASS ANGLED DIFFERENTIAL PRESSURE BY-PASS VALVE

Opening Differential Pressure Setting
Adjustable from 1.5 to 9 PSI

STANDARD BRASS				
SIZE	MAX GPM	ITEM#	CTN/CASE	CASE WT
FIP 145 PSI CWP Max/230°F Max				
3/4"	9	H-74533-A	1/36	22
1"	18	H-74544-A	1/36	28
MIP				
3/4"	9	H-72533-A	1/36	22
1"	18	H-72544-A	1/36	28
SWT				
3/4"	9	H-75533-A	1/36	22
1"	18	H-75544-A	1/36	28
Press				
3/4"	9	H-78533-A	1/36	22
1"	18	H-78544-A	1/36	28
BODY ONLY - INSTALL W/ (2) G1 UNION FITTINGS				
G1 Thread				
3/4"	9	H-70530-A	1/36	22
1"	18	H-70540-A	1/36	28

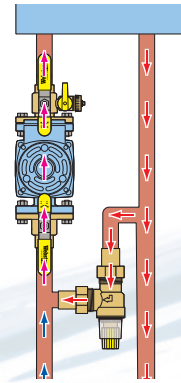

Under partial loads, the DPBV opens to ensure quiet operation and appropriate pressures at the boiler circulator. With all zones active, the DPBV remains closed

HYDRONIC G1 UNION ACCESSORIES

- Compatible with Vertical Air Separator, Magnetic Boiler Filter, Differential Pressure Bypass Valve
- Multiple options to customize your installation and simplify future service



THE ISOLATOR W/ ROTATING FLANGE

Full Port Forged DZR Brass Uni-Flange Ball Valve w/ Detachable Rotating Flange, Adjustable Packing Gland, Nuts & Bolts

LEAD-FREE BRASS

Certified to NSF/ANSI 61 & 372

SIZE	ITEM#	HV ITEM#	CTN/CASE	CASE WT
G1 Union x Rotating Flange 600 PSI CWP Max				
1"	H-G1404W	H-G1404WHV	1/20	34
W/ MULTI-FUNCTION HI-FLOW HOSE DRAIN				
G1 Union x Rotating Flange 600 PSI CWP Max				
1"	H-G1414W	H-G1414WHV	1/20	42

HV ITEMS FIT HIGH VELOCITY & STANDARD SIZE PUMPS.



FORGED DZR BRASS FITTING

LEAD-FREE BRASS

SIZE	ITEM#	CTN/CASE	CASE WT
G1 Union x FIP			
3/4"	H-7-2103W WP	10/100	34
1"	H-7-2104W WP	10/100	43
G1 Union x MIP			
3/4"	H-7-4103W WP	10/100	36
1"	H-7-4104W WP	10/100	39
G1 Union x SWT			
3/4"	H-7-5103W WP	10/100	29
1"	H-7-5104W WP	10/100	33
G1 Union x Press			
3/4"	H-7-8103W WP	10/100	39
1"	H-7-8104W WP	10/100	43

G1 UNION ELBOW

Forged DZR Brass Fitting

LEAD-FREE BRASS

Certified to NSF/ANSI 61 & 372

SIZE	ITEM#	CTN/CASE	CASE WT
G1 Union x G1 Thread 150 PSI CWP Max			
1"	H-7-G144W-A	10/60	29

ISOLATION BALL VALVE

Full Port Forged DZR Brass Valve w/ Reversible Yellow Handle

LEAD-FREE BRASS

Certified to NSF/ANSI 61 & 372

SIZE	ITEM#	CTN/CASE	CASE WT
G1 Union x G1 Thread 150 PSI CWP Max			
1"	H-7-G134WY	10/60	51
ANGLED			
1"	H-7-G134WY-A	10/60	56

DUAL SCALE TEMPERATURE GAUGE

w/ Integrated Forged Brass Fitting · 1½" Dial · Temperature Range 32° - 248°F

LEAD-FREE BRASS

Certified to NSF/ANSI 61 & 372

SIZE	ITEM#	CTN/CASE	CASE WT
G1 Union x G1 Thread 150 PSI			
1"	H-32000W	10/100	50

VERTICAL AIR SEPARATOR

KNOCKING PIPES ARE NOT NORMAL

- Reduces noise
- Improves system efficiency and operation
- Reduces wear on system components
- Vertical or horizontal mount options
- Flow may be directed into either side of the unit
- Wide range of G1 Union Accessories offer a solution for most installation needs - see page 19

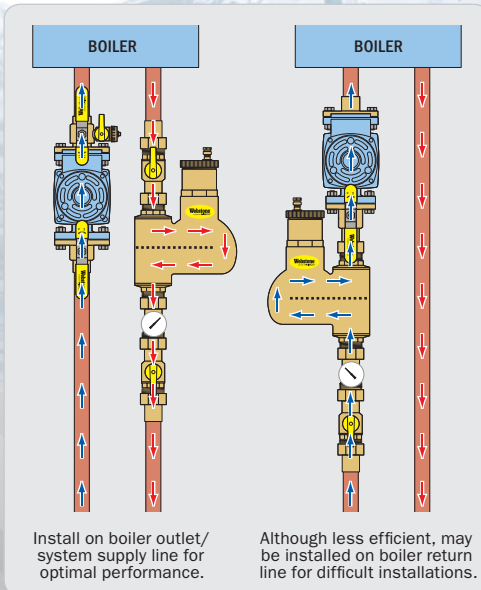
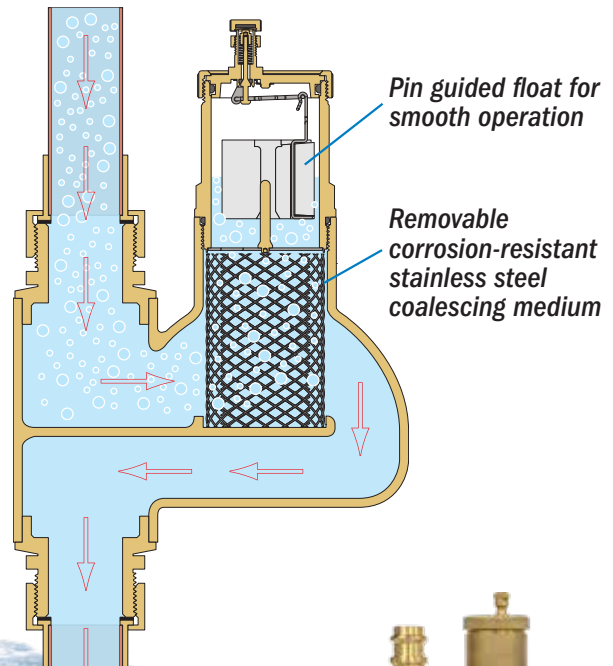

BRASS AIR SEPARATOR
w/ Removable Vent Head & Coalescing Medium - For Vertical Installations

SIZE	ITEM#	STANDARD BRASS	
		CTN/CASE	CASE WT
150 PSI/250°F Max			
FIP			
3/4"	H-74003-V	1/8	47
1"	H-74004-V	1/8	48
MIP			
3/4"	H-72003-V	1/8	45
1"	H-72004-V	1/8	47
SWT			
3/4"	H-75003-V	1/8	45
1"	H-75004-V	1/8	46
Press			
3/4"	H-78003-V	1/8	47
1"	H-78004-V	1/8	47
BODY ONLY - INSTALL W/ (2) G1 UNION FITTINGS			
G1 Thread			
1"	H-71000-V	1/8	41

HORIZONTAL AIR SEPARATOR



- Horizontal model includes FIP expansion tank connection

BRASS AIR SEPARATOR

w/ Removable Vent Head & Coalescing Medium

STANDARD BRASS			
SIZE	ITEM#	CTN/CASE	CASE WT
150 PSI/250°F Max			
FIP			
3/4"	H-74003	1/10	25
1"	H-74004	1/10	27
1 1/4"	H-74005	1/10	27
1 1/2"	H-74006	1/10	63
2"	H-74007	1/10	67
SWT			
3/4"	H-75003	1/10	25
1"	H-75004	1/10	25
1 1/4"	H-75005	1/10	25
1 1/2"	H-75006	1/10	65
2"	H-75007	1/10	65
Press			
3/4"	H-78003	1/10	30
1"	H-78004	1/10	32
1 1/4"	H-78005	1/10	36
1 1/2"	H-78006	1/10	76
2"	H-78007	1/10	85



- Replacement vent assembly compatible with vertical and horizontal air separator

REPLACEMENT VENT ASSEMBLY

SIZE	ITEM#	CTN/CASE	CASE WT
FITS 3/4"-2" AIR SEPARATOR	H-74000	1/50	13

IDEAL FOR USE WITH



SEE PAGE 25

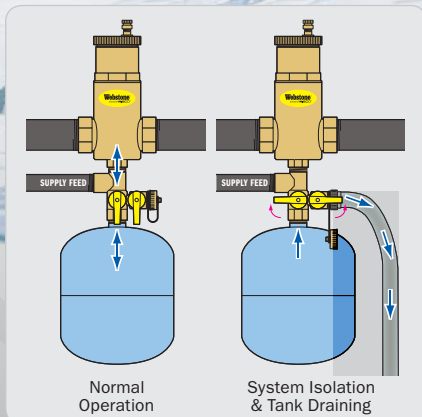



STEP SAVING VALVES FOR THE PROFESSIONAL

PATENTED TECHNOLOGY WITH FURTHER PATENTS PENDING



- Eliminates assemblies needed to isolate & drain any portion of a piped system
- Press or SWT × FIP options designed specifically for use with pre-fabricated threaded headers
- Avoids reduced-port alternatives
- Creates cleaner-looking, more efficient installations
- Reversible handle for added versatility
- Exclusive adjustable flow path allows for draining from either side of the ball

BALL DRAIN

Full Port Forged Brass Ball Valve w/ Hi-Flow Hose Drain, Reversible Handle & Adjustable Packing Glands

STANDARD BRASS

LEAD-FREE BRASS

Certified to NSF/ANSI 61 & 372

SIZE	ITEM#	CTN/CASE	CASE WT	ITEM#	CTN/CASE	CASE WT
FIP						
600 PSI CWP Max/350°F Max						
1/2"	H-40612	6/36	32	H-40612W	6/36	32
3/4"	H-40613	6/36	40	H-40613W	6/36	40
1"	H-40614	4/24	39	H-40614W	4/24	38
1 1/4"	H-40615	2/12	27	H-40615W	2/12	27
1 1/2"	H-40616	2/12	37	H-40616W	2/8	26
2"	H-40617	1/6	29	H-40617W	1/6	29
SWT						
600 PSI CWP Max/250°F Max						
1/2"	H-50612	6/36	29	H-50612W	6/36	29
3/4"	H-50613	6/36	39	H-50613W	6/36	39
1"	H-50614	4/24	38	H-50614W	4/24	37
1 1/4"	H-50615	2/12	27	H-50615W	2/12	27
1 1/2"	H-50616	2/12	41	H-50616W	2/8	27
2"	H-50617	1/6	32	H-50617W	1/6	30
SWT × FIP						
500 PSI CWP Max/250°F Max						
1/2"	H-54612	6/36	30	H-54612W	6/36	30
3/4"	H-54613	6/36	40	H-54613W	6/36	39
1"	H-54614	4/24	37	H-54614W	4/24	37
Press						
250 PSI CWP Max/250°F Max						
1/2"	H-80612	4/40	39	H-80612W	4/40	38
3/4"	H-80613	4/32	40	H-80613W	4/32	40
1"	H-80614	2/20	35	H-80614W	2/20	35
1 1/4"	H-80615	2/16	43	H-80615W	2/16	43
1 1/2"	-	-	-	H-80616W	1/8	29
2"	-	-	-	H-80617W	1/6	34
Press × FIP						
250 PSI CWP Max/250°F Max						
3/4"	H-84613	4/32	37	-	-	-
1"	H-84614	2/20	33	-	-	-
Press × ASTM F1960 PEX*						
250 PSI CWP Max PSI/250°F Max						
1/2"	-	-	-	H-83612W	4/40	38
3/4"	-	-	-	H-83613W	4/32	30
1"	-	-	-	H-83614W	2/20	19
1 1/4"	-	-	-	H-83615W	2/16	43
1 1/2"	-	-	-	H-83616W	1/8	30
2"	-	-	-	H-83617W	1/6	37
Press × ASTM F1807 PEX*						
250 PSI CWP Max PSI/250°F Max						
1/2"	-	-	-	H-81612W	4/40	38
3/4"	-	-	-	H-81613W	4/32	30
1"	-	-	-	H-81614W	2/20	19
1 1/4"	-	-	-	H-81615W	2/16	42
1 1/2"	-	-	-	H-81616W	1/8	29
2"	-	-	-	H-81617W	1/6	34
ASTM F1960 PEX*						
400 PSI CWP Max/200°F Max						
1/2"	-	-	-	H-30612W	4/40	35
3/4"	-	-	-	H-30613W	4/32	37
1"	-	-	-	H-30614W	2/20	32
1 1/4"	-	-	-	H-30615W	2/16	40
1 1/2"	-	-	-	H-30616W	1/8	28
2"	-	-	-	H-30617W	1/6	33
ASTM F1807 PEX*						
400 PSI CWP Max/200°F Max						
1/2"	-	-	-	H-10612W	4/40	34
3/4"	-	-	-	H-10613W	4/32	35
1"	-	-	-	H-10614W	2/20	31
1 1/4"	-	-	-	H-10615W	2/16	37
1 1/2"	-	-	-	H-10616W	1/8	26
2"	-	-	-	H-10617W	1/6	30

* CERTIFIED TO NSF/ANSI 61 & 372 NSF/ANSI 14

THE OLD WAY

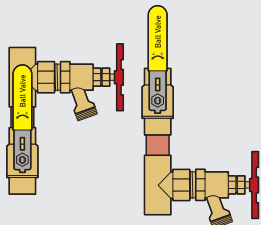

Draining from Above Ball Draining from Below Ball

THE WEBSTONE WAY

REPLACES 4 COMPONENTS SAVES 27 MINUTES ELIMINATES 3 LEAK PATHS



T-Flow Ball



Adjustable stem directs flow into the hi-flow hose drain from either side of the ball

DRAINING FROM ABOVE BALL

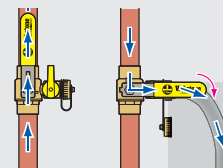

DRAINING FROM BELOW BALL

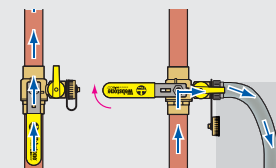

UNION BALL DRAIN™

Winterize an entire building with simple quarter-turn actions

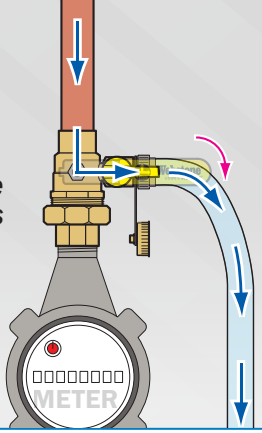

- All the features of the ball drain, with integrated union connection



THE OLD WAY

Draining from Above Ball Draining from Below Ball

THE WEBSTONE WAY

REPLACES SAVES ELIMINATES
6 45 5
 COMPONENTS MINUTES LEAK PATHS

UNION BALL DRAIN
 Full Port Forged Brass Ball Valve w/ Single Union End, Hi-Flow Hose Drain, Reversible Handle & Adjustable Packing Glands

STANDARD BRASS				LEAD-FREE BRASS		
				Certified to NSF/ANSI 61 & 372		
SIZE	ITEM#	CTN/CASE	CASE WT	ITEM#	CTN/CASE	CASE WT
FIP Union × FIP				600 PSI CWP Max/350°F Max		
3/4"	H-40433	6/24	41	H-40433W	6/24	40
1"	H-40434	4/16	36	H-40434W	4/16	36
1 1/4"	H-40435	2/12	40	H-40435W	2/12	38
1 1/2"	H-40436	2/12	56	H-40436W	2/8	38
FIP Union × SWT				600 PSI CWP Max/250°F Max		
3/4"	H-50433	6/24	40	H-50433W	6/24	39
1"	H-50434	4/16	36	H-50434W	4/16	31
1 1/4"	H-50435	2/12	38	H-50435W	2/12	38
1 1/2"	H-50436	2/12	56	H-50436W	2/8	38
FIP Union × Press				250 PSI CWP Max/250°F Max		
3/4"	-	-	-	H-80433W	4/16	28
1"	-	-	-	H-80434W	2/16	36
1 1/4"	-	-	-	H-80435W	2/8	27
1 1/2"	-	-	-	H-80436W	1/5	25
FIP Union × ASTM F1960 PEX*				250 PSI CWP Max/200°F Max		
1/2"	-	-	-	H-30432W	4/16	22
3/4"	-	-	-	H-30433W	4/16	27
1"	-	-	-	H-30434W	2/16	36
1 1/4"	-	-	-	H-30435W	2/8	27
1 1/2"	-	-	-	H-30436W	1/8	39
2"	-	-	-	H-30437W	1/4	29
FIP Union × ASTM F1807 PEX*				250 PSI CWP Max/200°F Max		
1/2"	-	-	-	H-10432W	4/16	22
3/4"	-	-	-	H-10433W	4/16	27
1"	-	-	-	H-10434W	2/16	35
1 1/4"	-	-	-	H-10435W	2/8	26
1 1/2"	-	-	-	H-10436W	1/8	38
2"	-	-	-	H-10437W	1/4	28

* CERTIFIED TO NSF/ANSI 61 & 372 NSF/ANSI 14

UNION BALL™

- Easily disconnect and replace any portion of a piped system

THE OLD WAY

THE WEBSTONE WAY

REPLACES SAVES ELIMINATES
3 18 2
 COMPONENTS MINUTES LEAK PATHS

UNION BALL
 Full Port Forged DZR Brass Ball Valve w/ Single Union End & Adjustable Packing Gland

LEAD-FREE BRASS
 Certified to NSF/ANSI 61 & 372

SIZE	ITEM#	CTN/CASE	CASE WT
FIP Union × FIP			
1/2"	H-40422W	5/40	35
3/4"	H-40423W	4/32	41
1"	H-40424W	4/20	37
FIP Union × SWT			
1/2"	H-50422W	5/40	33
3/4"	H-50423W	4/32	40
1"	H-50424W	4/20	36
FIP Union × Press			
1/2"	H-80422W	5/40	37
3/4"	H-80423W	4/32	43
1"	H-80424W	4/20	34
FIP Union × Push			
1/2"	H-60422W*	5/40	34
3/4"	H-60423W*	4/32	38
1"	H-60424W*	4/20	38
FIP Union × ASTM F1960 PEX			
1/2"	H-30422W†	5/40	33
3/4"	H-30423W†	4/32	40
1"	H-30424W†	4/20	36
FIP Union × ASTM F1807 PEX			
1/2"	H-10422W†	5/40	33
3/4"	H-10423W†	4/32	40
1"	H-10424W†	4/20	36

* CERTIFIED TO NSF/ANSI 61 & 372 NSF/ANSI 14 ASSE 1061
† CERTIFIED TO NSF/ANSI 61 & 372 NSF/ANSI 14



ALSO AVAILABLE

TWH SERVICE VALVES
E·X·P
 UNION BALL

Ideal for tanked and next-gen tankless water heater connections - See Page 11



- Installs anywhere a drain or purge valve is required
- Hi-flow alternative for filling, draining, or venting closed-loop hydronic systems



T-DRAIN

Full Port Forged Brass Fitting w/ Hi-Flow Hose Drain & Adjustable Packing Gland

LEAD-FREE BRASS

Certified to NSF/ANSI 61 & 372

SIZE	ITEM#	CTN/CASE	CASE WT
SWT			
600 PSI CWP Max/250°F Max			
1/2"	H-50672W	8/80	42
3/4"	H-50673W	6/48	39
1"	H-50674W	4/40	36
1 1/4"	H-50675W	4/40	43
1 1/2"	H-50676W	2/24	34
2"	H-50677W	2/20	34
Press			
250 PSI CWP Max/250°F Max			
1/2"	H-80672W	4/40	25
3/4"	H-80673W	4/16	16
1"	H-80674W	4/16	18
1 1/4"	H-80675W	4/16	20

THE OLD WAY

THE WEBSTONE WAY

REPLACES **2** COMPONENTS

SAVES **9** MINUTES

ELIMINATES **1** LEAK PATHS

HANDLE OPERATION

Normal Operation

System Purging



- Ideal for primary/secondary piping in mod-con boiler systems
- Provides precise spacing required for hydraulic separation
- Enables power purging of secondary loops, improving efficiency at system startup
- The only way to place a valve between closely spaced tees

PURGE-TEE

Full Port Forged Brass Ball Valve w/ Reversible Handle & Adjustable Packing Gland

STANDARD BRASS

SIZE	ITEM#	CTN/CASE	CASE WT
SWT (1" Primary Loop)			
600 PSI CWP Max			
1" x 3/4"	H-58643	1/12	23
1" x 1"	H-58644	1/12	24
SWT (1 1/4" Primary Loop)			
600 PSI CWP Max			
1 1/4" x 3/4"	H-58653	1/12	39
1 1/4" x 1"	H-58654	1/12	38
1 1/4" x 1 1/4"	H-58655	1/12	37
Press (1" Primary Loop)			
250 PSI CWP Max/250°F Max			
1" x 3/4"	H-88643	1/12	34
1" x 1"	H-88644	1/12	34
Press (1 1/4" Primary Loop)			
250 PSI CWP Max/250°F Max			
1 1/4" x 1"	H-88654	1/12	51
1 1/4" x 1 1/4"	H-88655	1/12	52

THE OLD WAY



THE WEBSTONE WAY

REPLACES **5** COMPONENTS

SAVES **36** MINUTES

ELIMINATES **4** LEAK PATHS

*Correct spacing for hydraulic separation cannot be achieved using off-the-shelf components.



POWER PURGING

Fluid is rapidly forced through the secondary loop, purging excess air from system through the drain

BOILER

Supply

Drain



PURGE & FILL

- Simultaneously drain, flush & refill any hydronic, solar, or closed loop system
- T-pattern flow path quickly and easily prevents the flow between the two hose connections
- As fluid is introduced into the system, the existing fluid or air is diverted out of the system through the remaining hose connection
- Reversible handle for added versatility

THE OLD WAY

THE WEBSTONE WAY

REPLACES 7 COMPONENTS SAVES 54 MINUTES ELIMINATES 6 LEAK PATHS

PURGE & FILL
Full Port Forged Brass Ball Valve w/ (2) Hi-Flow Hose Drains, Reversible Handle & Adjustable Packing Glands

STANDARD BRASS			
SIZE	ITEM#	CTN/CASE	CASE WT
600 PSI CWP Max			
FIP			
3/4"	H-48613	1/12	20
1"	H-48614	1/12	26
1 1/4"	H-48615	1/12	38
1 1/2"	H-48616	1/12	49
600 PSI CWP Max			
SWT			
3/4"	H-58613	1/12	23
1"	H-58614	1/12	26
1 1/4"	H-58615	1/12	38
1 1/2"	H-58616	1/12	51
250 PSI CWP Max/250°F Max			
Press			
3/4"	H-88613	1/12	20
1"	H-88614	1/12	27
1 1/4"	H-88615	1/12	40
1 1/2"	H-88616	1/6	27

Simultaneously Drain, Flush & Fill

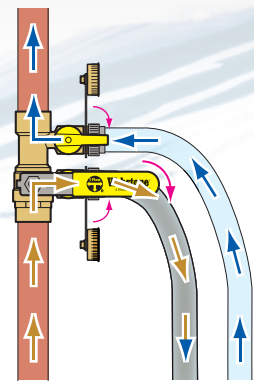

EXPANSION TANK PRO SERVICE VALVE

- The 3-way ball controls flow between the expansion tank and the system
- Easily install, isolate, drain & replace any expansion tank
- Quickly connect entire system to the cold water feed
- MIP model for direct connection to air separator or tee
- FIP model allows for distance between tank and system

THE OLD WAY

THE WEBSTONE WAY

REPLACES 7 COMPONENTS SAVES 54 MINUTES ELIMINATES 6 LEAK PATHS

HANDLE OPERATION

Normal Operation System Isolation & Tank Draining

EXPANSION TANK PRO SERVICE VALVE
Full Port Forged Brass Ball Valve w/ Hi-Flow Hose Drain

STANDARD BRASS			
SIZE	ITEM#	CTN/CASE	CASE WT
600 PSI CWP Max/250°F Max			
MIP/SWT × FIP × Hose			
1/2"	H-41672	1/30	29
600 PSI CWP Max			
FIP × Hose			
1/2"	H-44672	1/30	31

Ideal for use with Horizontal Air Separator
SEE PAGE 21

The ISOLATOR[®]

UNI-FLANGE BALL VALVE[®]

THE ONLY WAY TO ISOLATE CIRCULATOR PUMPS

PATENTED TECHNOLOGY WITH FURTHER PATENTS PENDING

The ISOLATOR[®]

UNI-FLANGE BALL VALVE[®]
with ROTATING FLANGE

The features and benefits you trust in our original Isolator line, with two versatile enhancements. The 360° flange rotation allows rotation to any degree necessary for your installation, and the multi-function drain that makes the Isolator the only valve that drains from both sides of the pump!

THE OLD WAY

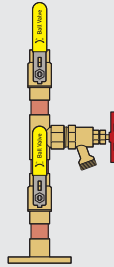

THE WEBSTONE WAY
REPLACES 8 COMPONENTS SAVES 63 MINUTES ELIMINATES 7 LEAK PATHS

PURGES BEFORE OR AFTER PUMP

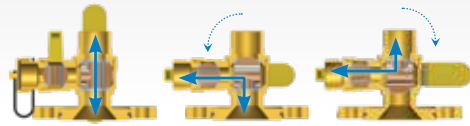

TWO FLANGE DESIGN OPTIONS

ALSO AVAILABLE W/ ROUND FLANGE FOR HIGH EFFICIENCY VARIABLE SPEED PUMPS - SEE PAGE 28

ITEM#

1/2" HOLE
FITS STANDARD
SIZE PUMPS

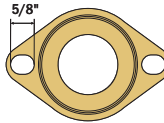
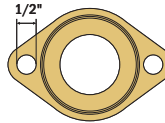

HV ITEM#

5/8" SLOTTED HOLE
FITS HIGH VELOCITY &
STANDARD SIZE PUMPS

THE ISOLATOR W/ ROTATING FLANGE

Full Port Forged Brass Uni-Flange Ball Valve w/ Detachable Rotating Flange, Adjustable Packing Gland, Nuts & Bolts

STANDARD BRASS

LEAD-FREE BRASS

Certified to NSF/ANSI 61 & 372

SIZE	ITEM#	HV ITEM#	CTN/CASE	CASE WT	ITEM#	HV ITEM#	CTN/CASE	CASE WT
FIP × Rotating Flange								
600 PSI CWP Max								
3/4"	H-41403	H-41403HV	1/20	27	H-41403W	H-41403WHV	2/20	27
1"	H-41404	H-41404HV	1/20	34	H-41404W	H-41404WHV	2/20	35
1 1/4"	H-41405	H-41405HV	1/20	41	H-41405W	H-41405WHV	2/10	45
1 1/2"	H-41406	H-41406HV	1/20	54	H-41406W	H-41406WHV	2/10	32
2"	-	-	-	-	-	H-41407WHV	1/10	34
SWT × Rotating Flange								
600 PSI CWP Max								
3/4"	H-51403	H-51403HV	1/20	25	H-51403W	H-51403WHV	2/20	27
1"	H-51404	H-51404HV	1/20	34	H-51404W	H-51404WHV	2/20	35
1 1/4"	H-51405	H-51405HV	1/20	41	H-51405W	H-51405WHV	2/20	45
1 1/2"	H-51406	H-51406HV	1/20	58	H-51406W	H-51406WHV	2/10	33
2"	-	-	-	-	-	H-51407WHV	1/10	34
Press × Rotating Flange								
250 PSI CWP Max/250°F Max								
3/4"	H-81403	H-81403HV	1/20	28	H-81403W	H-81403WHV	1/20	28
1"	H-81404	H-81404HV	1/20	40	H-81404W	H-81404WHV	1/20	40
1 1/4"	H-81405	H-81405HV	1/20	53	H-81405W	H-81405WHV	1/20	53
1 1/2"	H-81406	H-81406HV	1/10	32	H-81406W	H-81406WHV	1/10	32
2"	-	H-81407HV	1/10	36	-	H-81407WHV	1/10	51
ASTM F1960 PEX × Rotating Flange*								
400 PSI CWP Max								
3/4"	-	-	-	-	H-31403W	H-31403WHV	1/20	27
1"	-	-	-	-	H-31404W	H-31404WHV	1/20	27
ASTM F1807 PEX × Rotating Flange*								
400 PSI CWP Max								
3/4"	-	-	-	-	H-11403W	H-11403WHV	1/20	27
1"	-	-	-	-	H-11404W	H-11404WHV	1/20	29
W/ MULTI-FUNCTION HI-FLOW HOSE DRAIN								
600 PSI CWP Max								
FIP × Rotating Flange								
3/4"	H-41413	H-41413HV	2/20	36	H-41413W	H-41413WHV	2/20	35
1"	H-41414	H-41414HV	2/20	43	H-41414W	H-41414WHV	2/20	41
1 1/4"	H-41415	H-41415HV	2/20	54	H-41415W	H-41415WHV	2/10	27
1 1/2"	H-41416	H-41416HV	2/10	38	H-41416W	H-41416WHV	2/10	36
2"	-	-	-	-	-	H-41417WHV	1/10	38
SWT × Rotating Flange								
600 PSI CWP Max								
3/4"	H-51413	H-51413HV	2/20	36	H-51413W	H-51413WHV	2/20	36
1"	H-51414	H-51414HV	1/20	43	H-51414W	H-51414WHV	2/20	41
1 1/4"	H-51415	H-51415HV	2/20	54	H-51415W	H-51415WHV	2/10	28
1 1/2"	H-51416	H-51416HV	1/10	38	H-51416W	H-51416WHV	2/10	33
2"	-	-	-	-	-	H-51417WHV	1/10	36
Press × Rotating Flange								
250 PSI CWP Max/250°F Max								
3/4"	H-81413	H-81413HV	1/20	40	H-81413W	H-81413WHV	1/20	40
1"	H-81414	H-81414HV	1/20	48	H-81414W	H-81414WHV	1/20	48
1 1/4"	H-81415	H-81415HV	1/10	31	H-81415W	H-81415WHV	1/10	31
1 1/2"	H-81416	H-81416HV	1/10	38	H-81416W	H-81416WHV	1/10	38
2"	-	H-81417HV	1/10	40	-	H-81417WHV	1/10	53
ASTM F1960 PEX × Rotating Flange*								
400 PSI CWP Max								
3/4"	-	-	-	-	H-31413W	H-31413WHV	1/20	27
1"	-	-	-	-	H-31414W	H-31414WHV	1/20	27
ASTM F1807 PEX × Rotating Flange*								
400 PSI CWP Max								
3/4"	-	-	-	-	H-11413W	H-11413WHV	1/20	27
1"	-	-	-	-	H-11414W	H-11414WHV	1/20	27

* 2" ISOLATORS HAVE 1 1/2" PORT.

* ALSO CERTIFIED TO NSF/ANSI 14 & IAPMO ANSI Z1157

AVAILABLE W/
PRO-CONNECT PPR-PRO
EXCLUSIVELY FOR
aquatherm
SEE PAGE 32

AVAILABLE W/
PRO-CONNECT PPR-PRO
FOR ANY
PP-R OR PP-RCT
PIPING SYSTEM
SEE PAGE 33



These valves have revolutionized the installation of circulator pumps. Our original Isolator Uni-Flange Ball Valve design has evolved into the largest flanged ball valve program in the industry today.

- Conical inlet to minimize turbulence
- Fits virtually any standard circulator pump
- Available slotted holes for high velocity pumps
- Prevents electrolysis
- Eliminates galvanic corrosion



THE ISOLATOR UNI-FLANGE BALL VALVE

Full Port Forged Brass Ball Valve w/ Adjustable Packing Gland, Nuts & Bolts

STANDARD BRASS				
SIZE	ITEM#	HV ITEM#	CTN/CASE	CASE WT
FIP × Flange 600 PSI CWP Max				
1/2"	H-40402	-	1/20	24
3/4"	H-40403	-	1/20	29
1"	H-40404	H-40404HV	1/20	35
1 1/4"	H-40405	H-40405HV	1/20	41
1 1/2"	H-40406	H-40406HV	1/20	59
2"	-	H-40407HV	1/10	38
SWT × Flange 600 PSI CWP Max				
1/2"	H-50402	-	1/20	25
3/4"	H-50403	H-50403HV	1/20	28
1"	H-50404	H-50404HV	1/20	34
1 1/4"	H-50405	H-50405HV	1/20	41
1 1/2"	H-50406	H-50406HV	1/20	58
2"	-	H-50407HV	1/10	40
W/ HI-FLOW HOSE DRAIN 600 PSI CWP Max				
FIP × Flange				
3/4"	H-40413	H-40413HV	1/20	42
1"	H-40414	H-40414HV	1/20	49
1 1/4"	H-40415	H-40415HV	1/20	62
1 1/2"	H-40416	H-40416HV	1/10	41
2"	-	H-40417HV	1/10	57
SWT × Flange 600 PSI CWP Max				
3/4"	H-50413	H-50413HV	1/20	41
1"	H-50414	H-50414HV	1/20	50
1 1/4"	H-50415	H-50415HV	1/20	63
1 1/2"	H-50416	H-50416HV	1/10	43
2"	-	H-50417HV	1/10	57

HV ITEMS FIT HIGH VELOCITY & STANDARD SIZE PUMPS. 2" ISOLATORS HAVE 1 1/2" PORT.

THE ISOLATOR CIRCULATOR PUMP INSTALLATION KIT

Your choice of Isolator & Isolator w/ Drain & 2 Full-Faced Flange Gaskets, Nuts & Bolts

STANDARD BRASS					LEAD-FREE BRASS			
SIZE	ITEM#	HV ITEM#	CTN/CASE	CASE WT	ITEM#	HV ITEM#	CTN/CASE	CASE WT
THE ISOLATOR CIRCULATOR PUMP INSTALLATION KIT								
FIP × Flange 600 PSI CWP Max								
3/4"	H-40413KIT	H-40413HVKIT	1/10	36	-	-	-	-
1"	H-40414KIT	H-40414HVKIT	1/10	43	-	-	-	-
1 1/4"	H-40415KIT	H-40415HVKIT	1/10	52	-	-	-	-
SWT × Flange 600 PSI CWP Max								
3/4"	H-50413KIT	H-50413HVKIT	1/10	36	-	-	-	-
1"	H-50414KIT	H-50414HVKIT	1/10	43	-	-	-	-
1 1/4"	H-50415KIT	H-50415HVKIT	1/10	54	-	-	-	-
THE ISOLATOR W/ ROTATING FLANGE CIRCULATOR PUMP INSTALLATION KIT								
FIP × Rotating Flange 600 PSI CWP Max								
3/4"	H-41413KIT	H-41413HVKIT	1/10	32	H-41413WKIT	H-41413WHVKIT	1/10	32
1"	H-41414KIT	H-41414HVKIT	1/10	38	H-41414WKIT	H-41414WHVKIT	1/10	38
1 1/4"	H-41415KIT	H-41415HVKIT	1/10	49	H-41415WKIT	H-41415WHVKIT	1/10	52
SWT × Rotating Flange 600 PSI CWP Max								
3/4"	H-51413KIT	H-51413HVKIT	1/10	32	H-51413WKIT	H-51413WHVKIT	1/10	32
1"	H-51414KIT	H-51414HVKIT	1/10	38	H-51414WKIT	H-51414WHVKIT	1/10	38
1 1/4"	H-51415KIT	H-51415HVKIT	1/10	49	H-51415WKIT	H-51415WHVKIT	1/10	52

HV ITEMS FIT HIGH VELOCITY & STANDARD SIZE PUMPS. 2" ISOLATORS HAVE 1 1/2" PORT.



CIRCULATOR PUMP INSTALLATION KIT

INCLUDES EVERYTHING BUT THE PUMP!



DOUBLE FLANGED CHECK VALVE



SNUG-FIT ROTATING FLANGE



SECTION REMOVED TO SHOW INTERNAL CONSTRUCTION

The easiest way to add a check valve to any pump! Two sizes cover all standard Isolator installations.

- Installs between the pump & Isolator
- Limits SKUs and saves space on the truck!
- Replacement check assemblies available

THE ISOLATOR DOUBLE FLANGED CHECK

Forged Brass Check Valve w/ Rotating Flange - Includes One Set of Mounting Bolts & Full Faced Flange Gasket

STANDARD BRASS			
SIZE	HV ITEM#	CTN/CASE	CASE WT
Flange × Rotating Flange 150 PSI @ 200°F			
3/4" thru 1 1/4"	H-13703HV	1/10	16
1 1/2" thru 2"	H-13706HV	1/10	18

FITS STANDARD & HIGH VELOCITY PUMPS





The ISOLATOR[®]

UNI-FLANGE BALL VALVE[®]

with ROUND FLANGE

- Detachable rotating round flange
- Three flange styles designed specifically for each pump

THE ISOLATOR W/ ROUND FLANGE

Full Port Forged Brass Uni-Flange Ball Valve w/ Detachable Rotating Flange, Adjustable Packing Gland, Nuts & Bolts

STANDARD BRASS			
SIZE	HV ITEM#	CTN/CASE	CASE WT
FIP × Rotating Flange 600 PSI CWP Max			
1 1/2"	H-41406HV-RF375	1/6	22
2"	H-41407HV-RF400	1/6	30
2"	H-41407HV-RF475	1/6	31
SWT × Rotating Flange 600 PSI CWP Max			
1 1/2"	H-51406HV-RF375	1/6	22
2"	H-51407HV-RF400	1/6	32
2"	H-51407HV-RF475	1/6	33
Press × Rotating Flange 250 PSI CWP Max/250°F Max			
1 1/2"	H-81406HV-RF375	1/6	23
2"	H-81407HV-RF400	1/6	33
2"	H-81407HV-RF475	1/6	34

W/ MULTI-FUNCTION HI-FLOW HOSE DRAIN

FIP × Rotating Flange 600 PSI CWP Max			
1 1/2"	H-41416HV-RF375	1/6	26
2"	H-41417HV-RF400	1/6	37
2"	H-41417HV-RF475	1/6	38
SWT × Rotating Flange 600 PSI CWP Max			
1 1/2"	H-51416HV-RF375	1/6	26
2"	H-51417HV-RF400	1/6	38
2"	H-51417HV-RF475	1/6	39
Press × Rotating Flange 250 PSI CWP Max/250°F Max			
1 1/2"	H-81416HV-RF375	1/6	27
2"	H-81417HV-RF400	1/6	38
2"	H-81417HV-RF475	1/6	41

High Efficiency Variable Speed Pump						
MANUFACTURER*	ARMSTRONG	BELL & GOSSETT	GRUNDFOS	TACO		WILO
MODEL	E.2 Series E16.2/E16.2B, E30.2/E30.2B	ecocirc XL 15-75, XL 20-140, XL 40-200	Magna3 50-80 F, 50-150 F	00e VR15-1	00e VR20-1	Stratos 2.0 × 3-35
Isolator w/Round Flange						
COMPATIBLE FLANGE	RF400	RF400	RF475	RF375	RF475	RF400

RF375 FLANGE

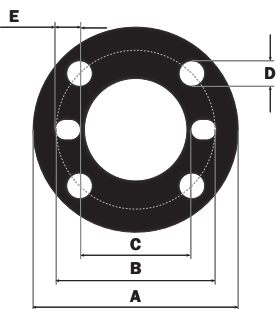

RF400 FLANGE

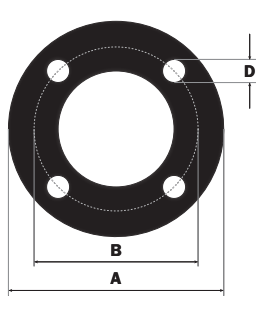

RF475 FLANGE

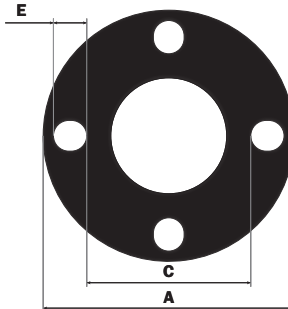

FLANGE DIMENSIONS

	A	B	C	D	E
RF375	5"	3 7/8"	2 11/16"	5/8"	5/8"
RF400	5 1/4"	4"	-	9/16"	-
RF475	6 1/8"	-	4"	-	13/16"

The ISOLATOR[®]

UNI-FLANGE BALL VALVE[®]

SELECT[™] WITH 4-WAY SELECTABLE FLOW PATH

IDEAL FOR GEOTHERMAL APPLICATIONS

- Easily fill, purge, sample or add a pressure gauge right at the pump
- 1" side ports enable quicker filling and purging - ideal for Geothermal applications
- Easily direct fluid between 4 available ports
- Easily isolate the pump for replacement



THE ISOLATOR SELECT

Full Port Forged Brass Uni-Flange Ball Valve w/ 4-Way Selectable Flow Path, Plugged FNPT Ports, Adjustable Packing Glands, Nuts & Bolts, Flange Gasket

STANDARD BRASS			
SIZE	HV ITEM#	CTN/CASE	CASE WT
FIP × Press × Rotating Flange 250 PSI CWP Max/250°F Max			
1"	H-81424HV	1/10	35

FITS STANDARD & HIGH VELOCITY PUMPS

2-PUMP GEOTHERMAL SYSTEM OVERVIEW

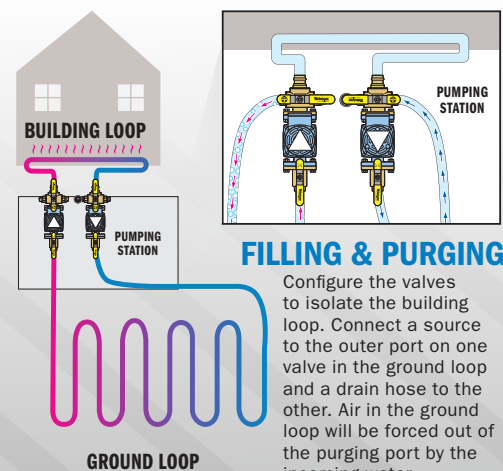

FILLING & PURGING

Configure the valves to isolate the building loop. Connect a source to the outer port on one valve in the ground loop and a drain hose to the other. Air in the ground loop will be forced out of the purging port by the incoming water.

CONNECTIONS FOR EVERY JOB



THREADED



SWEAT



PRO-CONNECT PRESS



PRO-CONNECT PPR PRO
aquatherm



PRO-CONNECT PPR PRO



PRO-CONNECT PRO PUSH



F1960 PEX



F1807 PEX



TRANSITION



HOSE



G1 UNION



COMPRESSION



FLANGE

F1960 & F1807 PEX PRODUCTS

NOW IN SIZES UP TO 2"



F1960 COLD EXPANSION

F1807 CRIMP OR CLAMP

FULL FLOW FORGED DZR BRASS BALL VALVE
w/ Stainless Steel Wing Style "T" Handle
& Adjustable Packing Gland

LEAD-FREE BRASS

Certified to NSF/ANSI 61 & 372
NSF/ANSI 14

SIZE	ITEM#	CTN/CASE	CASE WT
ASTM F1960 PEX 400 PSI CWP Max/250°F Max			
1/2"	H-31702WSSW	10/80	27
3/4"	H-31703WSSW	10/60	30
1"	H-31704WSSW	6/36	33
1 1/4"	H-31705WSSW	5/25	33
1 1/2"	H-31706WSSW	5/25	49
2"	H-31707WSSW	2/12	38
ASTM F1807 PEX 400 PSI CWP Max/250°F Max			
1/2"	H-11702WSSW	10/80	23
3/4"	H-11703WSSW	10/60	26
1"	H-11704WSSW	6/36	26



THE ISOLATOR W/ ROTATING FLANGE

Full Port Forged DZR Brass Uni-Flange Ball Valve w/ Detachable Rotating Flange, Adjustable Packing Gland, Nuts & Bolts

LEAD-FREE BRASS

Certified to NSF/ANSI 61 & 372
NSF/ANSI 14

SIZE	ITEM#	HV ITEM#	CTN/CASE	CASE WT
ASTM F1960 PEX × Rotating Flange 400 PSI CWP Max				
3/4"	H-31403W	H-31403WHV	1/20	27
1"	H-31404W	H-31404WHV	1/20	27
ASTM F1807 PEX × Rotating Flange 400 PSI CWP Max				
3/4"	H-11403W	H-11403WHV	1/20	27
1"	H-11404W	H-11404WHV	1/20	29
W/ MULTI-FUNCTION HI-FLOW HOSE DRAIN				
ASTM F1960 PEX × Rotating Flange 400 PSI CWP Max				
3/4"	H-31413W	H-31413WHV	1/20	27
1"	H-31414W	H-31414WHV	1/20	27
ASTM F1807 PEX × Rotating Flange 400 PSI CWP Max				
3/4"	H-11413W	H-11413WHV	1/20	27
1"	H-11414W	H-11414WHV	1/20	27

HV ITEMS FIT HIGH VELOCITY & STANDARD SIZE PUMPS.

The ISOLATOR
UNI-FLANGE BALL VALVE



PRO-PAL BALL DRAIN

Full Port Forged DZR Brass Ball Valve w/ Hi-Flow Hose Drain, Reversible Handle & Adjustable Packing Glands

LEAD-FREE BRASS

Certified to NSF/ANSI 61 & 372 NSF/ANSI 14

SIZE	ITEM#	CTN/CASE	CASE WT
ASTM F1960 PEX 400 PSI CWP Max/200°F Max			
1/2"	H-30612W	4/40	35
3/4"	H-30613W	4/32	37
1"	H-30614W	2/20	32
1 1/4"	H-30615W	2/16	40
1 1/2"	H-30616W	1/8	28
2"	H-30617W	1/6	33
ASTM F1807 PEX 400 PSI CWP Max/200°F Max			
1/2"	H-10612W	4/40	34
3/4"	H-10613W	4/32	35
1"	H-10614W	2/20	31
1 1/4"	H-10615W	2/16	37
1 1/2"	H-10616W	1/8	26
2"	H-10617W	1/6	30

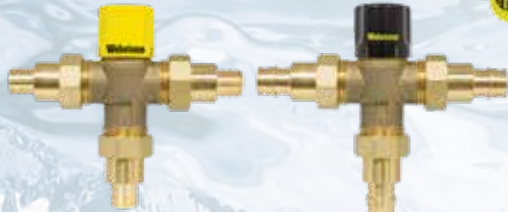
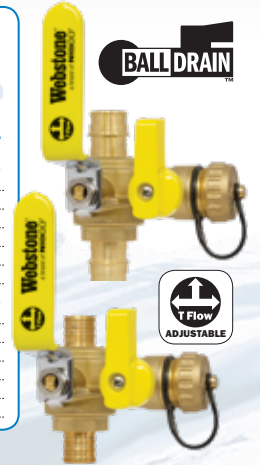

THERMOSTATIC MIXING VALVE W/ INTEGRAL CHECK VALVES

Forged Brass Valve w/ DZR Brass Fittings, Temperature Locking Handle* & G1 Union Connections

See page 4 for application & certification information

SIZE	ITEM#	CTN/CASE	CASE WT
OUTLET TEMPERATURE RANGE 95°- 120°F			
ASTM F1960 PEX 150 PSI/185°F Max			
1/2"	H-73202W-CE-CAN	1/10	18
3/4"	H-73203W-CE-CAN	1/10	18
ASTM F1807 PEX 150 PSI/185°F Max			
1/2"	H-71202W-CAN	1/10	18
3/4"	H-71203W-CAN	1/10	18
OUTLET TEMPERATURE RANGE 95°- 131°F			
ASTM F1960 PEX 150 PSI/185°F Max			
1/2"	H-73202W-CE	1/10	18
3/4"	H-73203W-CE	1/10	18
ASTM F1807 PEX 150 PSI/185°F Max			
1/2"	H-71202W	1/10	18
3/4"	H-71203W	1/10	18
OUTLET TEMPERATURE RANGE 104°- 176°F			
ASTM F1960 PEX 150 PSI/203°F Max			
1/2"	H-73272W	1/10	18
3/4"	H-73273W	1/10	18
ASTM F1807 PEX 150 PSI/203°F Max			
1/2"	H-71272W	1/10	18
3/4"	H-71273W	1/10	18

*TEMPERATURE LOCKING HANDLE NOT AVAILABLE ON -CAN ITEMS

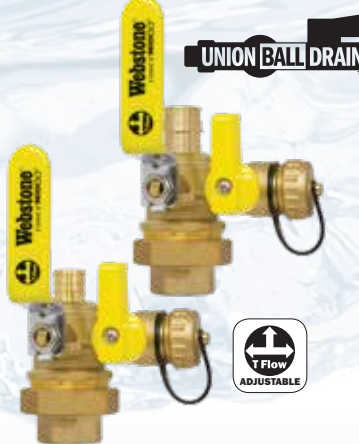

PRO-PAL UNION BALL DRAIN

Full Port Forged DZR Brass Ball Valve w/ Single Union End, Hi-Flow Hose Drain, Reversible Handle & Adjustable Packing Glands

LEAD-FREE BRASS

Certified to NSF/ANSI 61 & 372 NSF/ANSI 14

SIZE	ITEM#	CTN/CASE	CASE WT
FIP Union × ASTM F1960 PEX 250 PSI CWP Max/200°F Max			
1/2"	H-30432W	4/16	22
3/4"	H-30433W	4/16	27
1"	H-30434W	2/16	36
1 1/4"	H-30435W	2/8	27
1 1/2"	H-30436W	1/8	39
2"	H-30437W	1/4	29
FIP Union × ASTM F1807 PEX 250 PSI CWP Max/200°F Max			
1/2"	H-10432W	4/16	22
3/4"	H-10433W	4/16	27
1"	H-10434W	2/16	35
1 1/4"	H-10435W	2/8	26
1 1/2"	H-10436W	1/8	38
2"	H-10437W	1/4	28

PRO-PAL UNION BALL

Full Port Forged DZR Brass Ball Valve w/ Single Union End & Adjustable Packing Gland

LEAD-FREE BRASS

Certified to NSF/ANSI 61 & 372 NSF/ANSI 14

SIZE	ITEM#	CTN/CASE	CASE WT
FIP Union × ASTM F1960 PEX 250 PSI CWP Max/200°F Max			
1/2"	H-30422W	5/40	33
3/4"	H-30423W	4/32	40
1"	H-30424W	4/20	36
FIP Union × ASTM F1807 PEX 250 PSI CWP Max/200°F Max			
1/2"	H-10422W	5/40	33
3/4"	H-10423W	4/32	40
1"	H-10424W	4/20	36



FULL FLOW FORGED NICKEL-PLATED BRASS SILCOCK

1/4 Turn Action w/ Stainless Steel Lever Handle

LEAD-FREE BRASS

SIZE	ITEM#	CTN/CASE	CASE WT
ASTM F1960 PEX Flange × MIP Hose 125 PSI CWP MAX			
1/2"	H-33202WSSL	12/72	58



CHROME-PLATED EXTRUDED BRASS MINI BALL VALVE

Hex Body

STANDARD BRASS

SIZE	ITEM#	CTN/CASE	CASE WT
ASTM F1807 PEX 110 PSI CWP Max NON-SHOCK			
1/2"	H-40782	30/300	61

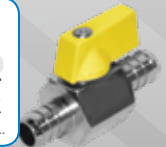

F1960 & F1807 PEX PRODUCTS

E-X-P E2 TANKLESS WATER HEATER SERVICE VALVE KIT

Hot & Cold Set of Full Port Forged DZR Brass Ball Valves w/ Hi-Flow Hose Drains & Adjustable Packing Glands
See page 10 for application information

LEAD-FREE BRASS

Certified to NSF/ANSI 61 & 372 NSF/ANSI 14

SIZE	ITEM#	CTN/CASE	CASE WT
FIP Union * ASTM F1960 PEX 400 PSI CWP Max/200°F Max			
3/4"	H-34063W	1/10	34
FIP Union * ASTM F1807 PEX 400 PSI CWP Max/200°F Max			
3/4"	H-14063W	1/10	33
W/ PRESSURE RELIEF VALVE OUTLET			
FIP Union * ASTM F1960 PEX 400 PSI CWP Max			
3/4"	H-34443W	1/10	34
FIP Union * ASTM F1807 PEX 400 PSI CWP Max			
3/4"	H-14443W	1/10	33
INCLUDES RESIDENTIAL PRESSURE RELIEF VALVE (150 PSI/500,000 BTU/HR)			
FIP Union * ASTM F1960 PEX 400 PSI CWP Max			
3/4"	H-34443WPR	1/10	38
FIP Union * ASTM F1807 PEX 400 PSI CWP Max			
3/4"	H-14443WPR	1/10	38

TWH SERVICE VALVES
E-X-P E2
SPACE SAVING



TWH SERVICE VALVES
E-X-P
UNION BALL



E-X-P UNION BALL TANKLESS WATER HEATER SERVICE VALVE KIT

Hot & Cold Set of Full Port Forged DZR Brass Ball Valves w/ Union Ends & Adjustable Packing Glands
See page 10 for application information

LEAD-FREE BRASS

Certified to NSF/ANSI 61 & 372 NSF/ANSI 14

SIZE	ITEM#	CTN/CASE	CASE WT
FIP Union * ASTM F1960 PEX 250 PSI CWP Max/200°F Max			
3/4"	H-30423W-RB	1/12	30
FIP Union * ASTM F1807 PEX 250 PSI CWP Max/200°F Max			
3/4"	H-10423W-RB	1/12	30

PEX TRANSITION VALVES & FITTINGS

FULL PORT FORGED DZR BRASS BALL VALVE

w/ Adjustable Packing Gland

LEAD-FREE BRASS

Certified to NSF/ANSI 61 & 372 NSF/ANSI 14

SIZE	ITEM#	CTN/CASE	CASE WT
Press * ASTM F1960 PEX 250 PSI CWP Max PSI/250°F Max			
1/2"	H-80332W	5/50	26
3/4"	H-80333W	5/40	21
1"	H-80334W	4/20	11
1 1/4"	H-80335W	5/20	46
1 1/2"	H-80336W	4/16	44
2"	H-80337W	2/8	40
Press * ASTM F1807 PEX 250 PSI CWP Max PSI/250°F Max			
1/2"	H-80132W	5/50	26
3/4"	H-80133W	5/40	21
1"	H-80134W	4/20	11
1 1/4"	H-80135W	5/20	44
1 1/2"	H-80136W	4/16	42
2"	H-80137W	2/8	36

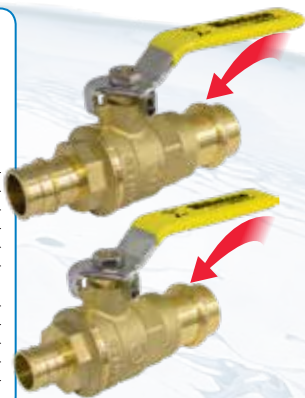

PRO-CONNECT PRESS

Compatible with popular press tools

FORGED DZR BRASS TRANSITION FITTING

LEAD-FREE BRASS

Certified to NSF/ANSI 61 & 372 NSF/ANSI 14 IGC 319, PS117

SIZE	ITEM#	CTN/CASE	CASE WT
Press * ASTM F1960 PEX 250 PSI CWP Max/250°F Max			
1/2"	H-36802W	30/120	10
3/4"	H-36803W	30/120	17
1"	H-36804W	30/120	27
1 1/4"	H-36805W	20/80	29
1 1/2"	H-36806W	20/80	46
2"	H-36807W	9/27	29
Press * ASTM F1807 PEX 250 PSI CWP Max/250°F Max			
1/2"	H-16802W	30/120	8
3/4"	H-16803W	30/120	14
1"	H-16804W	30/120	20
1 1/4"	H-16805W	20/80	21
1 1/2"	H-16806W	20/80	67
2"	H-16807W	9/27	46



PRO-PAL BALL DRAIN

Full Port Forged DZR Brass Ball Valve w/ Hi-Flow Hose Drain, Reversible Handle & Adjustable Packing Glands

LEAD-FREE BRASS

Certified to NSF/ANSI 61 & 372 NSF/ANSI 14

SIZE	ITEM#	CTN/CASE	CASE WT
Press * ASTM F1960 PEX 250 PSI CWP Max PSI/250°F Max			
1/2"	H-83612W	4/40	38
3/4"	H-83613W	4/32	30
1"	H-83614W	2/20	19
1 1/4"	H-83615W	2/16	43
1 1/2"	H-83616W	1/8	30
2"	H-83617W	1/6	37
Press * ASTM F1807 PEX 250 PSI CWP Max PSI/250°F Max			
1/2"	H-81612W	4/40	38
3/4"	H-81613W	4/32	30
1"	H-81614W	2/20	19
1 1/4"	H-81615W	2/16	42
1 1/2"	H-81616W	1/8	29
2"	H-81617W	1/6	34

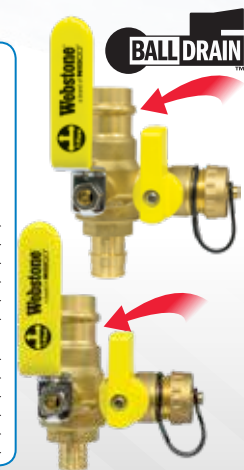

FORGED DZR BRASS 90° TRANSITION ELBOW

LEAD-FREE BRASS

Certified to NSF/ANSI 61 & 372 NSF/ANSI 14 IGC 319, PS117

SIZE	ITEM#	CTN/CASE	CASE WT
Press * ASTM F1960 PEX 250 PSI CWP Max/250°F Max			
1/2"	H-36842W	32/128	21
3/4"	H-36843W	32/128	35
1"	H-36844W	32/128	63
1 1/4"	H-36845W	18/54	40
1 1/2"	H-36846W	18/54	50
2"	H-36847W	8/16	28
Press * ASTM F1807 PEX 250 PSI CWP Max/250°F Max			
1/2"	H-16842W	32/128	14
3/4"	H-16843W	32/128	25
1"	H-16844W	32/128	45
1 1/4"	H-16845W	18/54	36
1 1/2"	H-16846W	18/54	49
2"	H-16847W	8/16	27

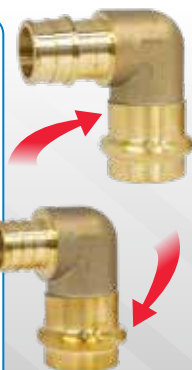

FULL FLOW FORGED DZR BRASS BALL VALVE

w/ Stainless Steel Wing Style "T" Handle & Adjustable Packing Gland

LEAD-FREE BRASS

Certified to NSF/ANSI 61 & 372 NSF/ANSI 14

SIZE	ITEM#	CTN/CASE	CASE WT
ASTM F1960 PEX * FIP 400 PSI CWP Max/250°F Max			
1/2"	H-34702WSSW	10/80	29
3/4"	H-34703WSSW	10/60	32
1"	H-34704WSSW	6/36	32
ASTM F1807 PEX * FIP 400 PSI CWP Max/250°F Max			
1/2"	H-14702WSSW	10/80	26
3/4"	H-14703WSSW	10/60	29
1"	H-14704WSSW	6/36	29



FULL FLOW FORGED BRASS BALL VALVE

w/ Wing Handle

SIZE	ITEM#	STANDARD BRASS CTN/CASE	CASE WT
ASTM F1807 PEX * SWT 160 PSI CWP MAX			
1/2"	H-50682	10/100	25



PRO-CONNECT™ PP-R PRO™

INNOVATIVE VALVES FOR AQUATHERM® PP-R PIPE

PATENTED TECHNOLOGY WITH FURTHER PATENTS PENDING

- Permanent leak-free heat fused connections made in seconds
- Compatible with all Aquatherm PP-R piping systems
- Safe, clean, long-lasting, high performance materials
- Suitable for potable applications
- Available in female metric socket nominal sizes 1/2" to 2"
- Saves labor, space & leak paths
- Available exclusively at Aquatherm dealers



BALL VALVE

Full Port Forged Brass Ball Valve w/ Adjustable Packing Gland

LEAD-FREE BRASS

Certified to NSF/ANSI 61 & 372

SIZE	SOCKET I.D.	ITEM#	CTN/CASE	CASE WT
Female PP-R Metric Socket 355 PSI*				
1/2"	20 mm	H-91702W	5/50	30
3/4"	25 mm	H-91703W	5/40	35
1"	32 mm	H-91704W	4/20	33
1 1/4"	40 mm	H-91705W	5/20	49
1 1/2"	50 mm	H-91706W	4/16	57
2"	63 mm	H-91707W	2/8	39
Female PP-R Metric Socket × FIP 355 PSI*				
1/2"	20 mm	H-94702W	5/50	28
3/4"	25 mm	H-94703W	5/40	33
1"	32 mm	H-94704W	4/20	29
1 1/4"	40 mm	H-94705W	5/20	43
1 1/2"	50 mm	H-94706W	4/16	50
2"	63 mm	H-94707W	2/8	34



THE ISOLATOR W/ ROTATING FLANGE & MULTI-FUNCTION DRAIN

Full Port Forged Brass Uni-Flange Ball Valve w/ Detachable Rotating Flange, Multi-Function Hi-Flow Hose Drain, Adjustable Packing Glands, Nuts & Bolts

LEAD-FREE BRASS

Certified to NSF/ANSI 61 & 372

SIZE	SOCKET I.D.	HV ITEM#	CTN/CASE	CASE WT
Female PP-R Metric Socket × Rotating Flange 355 PSI*				
3/4"	25 mm	H-91413WHV	1/20	36
1"	32 mm	H-91414WHV	1/20	45
1 1/4"	40 mm	H-91415WHV	1/10	32
1 1/2"	50 mm	H-91416WHV	1/10	40
2"	63 mm	H-91417WHV	1/10	43

FITS STANDARD & HIGH VELOCITY PUMPS - 2" ISOLATORS HAVE 1 1/2" PORT

BALL DRAIN

Full Port Forged Brass Ball Valve w/ Hi-Flow Hose Drain, Reversible Handle & Adjustable Packing Glands

LEAD-FREE BRASS

Certified to NSF/ANSI 61 & 372

SIZE	SOCKET I.D.	ITEM#	CTN/CASE	CASE WT
Female PP-R Metric Socket 355 PSI*				
3/4"	25 mm	H-90613W	4/32	39
1"	32 mm	H-90614W	2/20	40
1 1/4"	40 mm	H-90615W	2/16	47
1 1/2"	50 mm	H-90616W	1/8	33
2"	63 mm	H-90617W	1/6	35



STEM EXTENSION KIT

- Replaces existing handle
- Accommodates up to 2" of insulation
- Improves handle accessibility



STEM EXTENSION KIT

For Use with Series Valves

VALVE SIZE	ITEM#	CTN/CASE	CASE WT
FITS BALL VALVE (9170 & 9470 SERIES)			
1/2" & 3/4"	H-SE-91702	12/48	23
1"	H-SE-91704	10/40	27
1 1/4"	H-SE-91705	8/32	24
1 1/2"	H-SE-91706	6/24	28
2"	H-SE-91707	6/24	28
FITS ISOLATOR W/ ROTATING FLANGE AND BALL DRAIN (9061 SERIES)			
3/4"	H-SE-91702	12/48	23
1"	H-SE-91704	10/40	27
1 1/4"	H-SE-91705	8/32	24
1 1/2" & 2"	H-SE-91706	6/24	28
FITS ISOLATOR W/ ROTATING FLANGE & MULTI-FUNCTION DRAIN (9141 SERIES)			
3/4"	H-SE-91413	12/48	24
1"	H-SE-91414	10/40	27
1 1/4"	H-SE-91415	8/32	24
1 1/2" & 2"	H-SE-91416	8/24	29



THE ISOLATOR W/ ROTATING FLANGE

Full Port Forged Brass Uni-Flange Ball Valve w/ Detachable Rotating Flange, Adjustable Packing Glands, Nuts & Bolts

LEAD-FREE BRASS

Certified to NSF/ANSI 61 & 372

SIZE	SOCKET I.D.	HV ITEM#	CTN/CASE	CASE WT
Female PP-R Metric Socket × Rotating Flange 355 PSI*				
3/4"	25 mm	H-91403WHV	1/20	28
1"	32 mm	H-91404WHV	1/20	39
1 1/4"	40 mm	H-91405WHV	1/20	49
1 1/2"	50 mm	H-91406WHV	1/10	36
2"	63 mm	H-91407WHV	1/10	38

FITS STANDARD & HIGH VELOCITY PUMPS - 2" ISOLATORS HAVE 1 1/2" PORT

PRO-CONNECT™ PP-R PRO

INNOVATIVE VALVES FOR ANY PP-R PIPE

PATENTED TECHNOLOGY WITH FURTHER PATENTS PENDING

- Permanent leak-free heat fused connections made in seconds
- PP-RCT sockets compatible with all PP-R & PP-RCT piping systems†
- Safe, clean, long-lasting, high performance materials
- Suitable for potable applications
- Available in female metric socket nominal sizes 1/2" to 2"
- Saves labor, space & leak paths

The ISOLATOR
UNI-FLANGE BALL VALVE®



THE ISOLATOR W/ ROTATING FLANGE & MULTI-FUNCTION DRAIN

Full Port Forged Brass Uni-Flange Ball Valve w/ Detachable Rotating Flange, Multi-Function Hi-Flow Hose Drain, Adjustable Packing Glands, Nuts & Bolts

LEAD-FREE BRASS

Certified to NSF/ANSI 61 & 372

SIZE	SOCKET I.D.	HV ITEM#	CTN/CASE	CASE WT
Female PP-RCT Metric Socket × Rotating Flange 600 PSI*				
3/4"	25 mm	H-101413WHV	1/20	36
1"	32 mm	H-101414WHV	1/20	45
1 1/4"	40 mm	H-101415WHV	1/10	32
1 1/2"	50 mm	H-101416WHV	1/10	38
2"	63 mm	H-101417WHV	1/10	43

FITS STANDARD & HIGH VELOCITY PUMPS - 2" ISOLATORS HAVE 1 1/2" PORT

The ISOLATOR
UNI-FLANGE BALL VALVE®



THE ISOLATOR W/ ROTATING FLANGE

Full Port Forged Brass Uni-Flange Ball Valve w/ Detachable Rotating Flange, Adjustable Packing Glands, Nuts & Bolts

LEAD-FREE BRASS

Certified to NSF/ANSI 61 & 372

SIZE	SOCKET I.D.	HV ITEM#	CTN/CASE	CASE WT
Female PP-RCT Metric Socket × Rotating Flange 600 PSI*				
3/4"	25 mm	H-101403WHV	1/20	29
1"	32 mm	H-101404WHV	1/20	39
1 1/4"	40 mm	H-101405WHV	1/20	54
1 1/2"	50 mm	H-101406WHV	1/10	36
2"	63 mm	H-101407WHV	1/10	38

FITS STANDARD & HIGH VELOCITY PUMPS - 2" ISOLATORS HAVE 1 1/2" PORT

BALL VALVE

Full Port Forged Brass Ball Valve w/ Adjustable Packing Gland

LEAD-FREE BRASS

Certified to NSF/ANSI 61 & 372

SIZE	SOCKET I.D.	ITEM#	CTN/CASE	CASE WT
Female PP-RCT Metric Socket 600 PSI*				
1/2"	20 mm	H-101702W	5/50	31
3/4"	25 mm	H-101703W	5/40	36
1"	32 mm	H-101704W	4/20	33
1 1/4"	40 mm	H-101705W	5/20	49
1 1/2"	50 mm	H-101706W	4/16	57
2"	63 mm	H-101707W	2/8	40
Female PP-RCT Metric Socket × FIP 600 PSI*				
1/2"	20 mm	H-104702W	5/50	28
3/4"	25 mm	H-104703W	5/40	33
1"	32 mm	H-104704W	4/20	29
1 1/4"	40 mm	H-104705W	5/20	42
1 1/2"	50 mm	H-104706W	4/16	50
2"	63 mm	H-104707W	2/8	35



PRO-PAL
SERIES

BALL DRAIN™



BALL DRAIN

Full Port Forged Brass Ball Valve w/ Hi-Flow Hose Drain, Reversible Handle & Adjustable Packing Glands

LEAD-FREE BRASS

Certified to NSF/ANSI 61 & 372

SIZE	SOCKET I.D.	ITEM#	CTN/CASE	CASE WT
Female PP-RCT Metric Socket 600 PSI*				
3/4"	25 mm	H-100613W	4/32	39
1"	32 mm	H-100614W	2/20	40
1 1/4"	40 mm	H-100615W	2/16	47
1 1/2"	50 mm	H-100616W	1/8	33
2"	63 mm	H-100617W	1/6	35

STEM EXTENSION KIT

- Replaces existing handle
- Accommodates up to 2" of insulation
- Improves handle accessibility



STEM EXTENSION KIT

For Use with Series Valves

VALVE SIZE	ITEM#	CTN/CASE	CASE WT
FITS BALL VALVE (10170 & 10470 SERIES)			
1/2" & 3/4"	H-SE-91702	12/48	23
1"	H-SE-91704	10/40	27
1 1/4"	H-SE-91705	8/32	24
1 1/2"	H-SE-91706	6/24	28
2"	H-SE-91707	6/24	28

FITS ISOLATOR W/ ROTATING FLANGE AND BALL DRAIN (10061 SERIES)

3/4"	H-SE-91702	12/48	23
1"	H-SE-91704	10/40	27
1 1/4"	H-SE-91705	8/32	24
1 1/2" & 2"	H-SE-91706	6/24	28

FITS ISOLATOR W/ ROTATING FLANGE & MULTI-FUNCTION DRAIN (10141 SERIES)

3/4"	H-SE-91413	12/48	24
1"	H-SE-91414	10/40	27
1 1/4"	H-SE-91415	8/32	24
1 1/2" & 2"	H-SE-91416	8/24	29

†In accordance with piping manufacturer's installation and warranty requirements. Valve seat/body maximum pressure rating at 100° F. Overall valve pressure rating is determined by intended operating conditions and limitations specific to the system design.

PRO-CONNECT PRO PUSH™

PRO PERFORMANCE PUSH CONVENIENCE



PRO-CONNECT PROPUSH BALL VALVE
Full Port Forged DZR Brass w/ Adjustable Packing Gland · For Connection to Copper, CPVC, or PEX

LEAD-FREE BRASS
Certified to NSF/ANSI 61 & 372
NSF/ANSI 14 ASSE 1061

SIZE	ITEM#	CTN/CASE	CASE WT
Push			200 PSI/200°F Max
1/2"	H-62702W	10/100	44
3/4"	H-62703W	10/100	63
1"	H-62704W	5/50	56

ALSO AVAILABLE W/PUSH CONNECTIONS

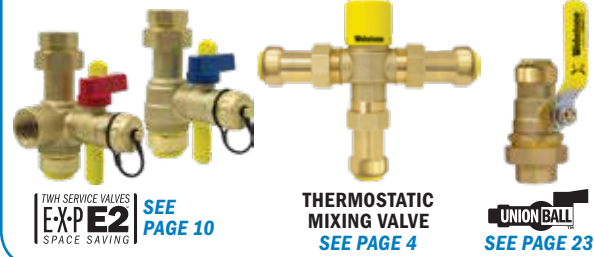

TW SERVICE VALVES
EX-PE2
SPACE SAVING
SEE PAGE 10

THERMOSTATIC MIXING VALVE
SEE PAGE 4

UNION BALL
SEE PAGE 23

PRO-CONNECT PROPUSH IN-LINE SPRING CHECK VALVE
Forged DZR Brass Fitting · For Connection to Copper, CPVC or PEX

LEAD-FREE BRASS
Certified to NSF/ANSI 61 & 372
ASSE 1061

SIZE	ITEM#	CTN/CASE	CASE WT
Push			200 PSI/200°F Max
1/2"	H-26992W-B	6/120	20
3/4"	H-26993W	12/120	39
1"	H-26994W-B	3/45	25



PRO-CONNECT PROPUSH CONTRACTOR PUSH FITTING KIT
27-Piece Assortment of Fittings & Tools · For Connection to Copper, CPVC, or PEX

LEAD-FREE BRASS
Certified to NSF/ANSI 61-G ASSE 1061
AMSE A112.18.6 CSA B125.6

SIZE	ITEM#	CTN/CASE	CASE WT
KIT	H-26000WKIT	1/4	30



FREE CUSTOMIZED LABELING
WHEN YOU ORDER 100 UNITS OR MORE



PRO-CONNECT PROPUSH 1/4 TURN SUPPLY STOP
Chrome Plated DZR Brass · For Connection to Copper, CPVC or PEX

LEAD-FREE BRASS
Certified to NSF/ANSI 61 & 372
ASSE 1061 AMSE A112.18.6 CSA B125.6

SIZE	ITEM#	CTN/CASE	CASE WT
ANGLED			
Push × Compression			
1/2" × 1/4"	H-26820W	20/200	53
1/2" × 3/8"	H-26821W	20/200	53
STRAIGHT			
Push × Compression			
1/2" × 1/4"	H-26920W	20/200	49
1/2" × 3/8"	H-26921W	20/200	49

PRO-CONNECT PROPUSH WATER HEATER INSTALLATION KIT
Includes (2) Push × FIP Straight Connectors & Removal Tool · For Connection to Copper, CPVC or PEX

LEAD-FREE BRASS
Certified to NSF/ANSI 61 & 372
ASSE 1061

SIZE	ITEM#	CTN/CASE	CASE WT
Push × FIP			200 PSI/200°F Max
1/2" × 3/4"	H-26223WKIT	5/50	29
3/4"	H-26203WKIT	5/50	29



PRO-CONNECT PROPUSH FLEXIBLE WATER HEATER CONNECTOR
Braided Stainless Steel · For Connection to Copper, CPVC or PEX

LEAD-FREE BRASS
Certified to NSF/ANSI 61-G ASSE 1061
AMSE A112.18.6 CSA B125.6

SIZE	LENGTH	ITEM#	CTN/CASE	CASE WT
Push × FIP				
1/2" × 3/4"	12"	H-26023W-12-B	12/60	18
3/4"	12"	H-26033W-12	1/50	31
1/2" × 3/4"	15"	H-26023W-15-B	12/60	20
3/4"	15"	H-26033W-15	1/50	33
1/2" × 3/4"	18"	H-26023W-18	1/50	21
3/4"	18"	H-26033W-18	1/50	41
1/2" × 3/4"	24"	H-26023W-24-B	12/60	25
3/4"	24"	H-26033W-24	1/50	44
W/ FULL PORT FORGED DZR BRASS BALL VALVE				
1/2" × 3/4"	18"	H-62023W-18	1/25	19
3/4"	18"	H-62033W-18	1/25	31



PRO-CONNECT PROPUSH TAP-A-LINE KIT
Includes: Repair Tee, CTS, Straight Supply Stop & Removal Tool · For Connection to Copper, CPVC, or PEX

LEAD-FREE BRASS
Certified to NSF/ANSI 61 & 372
ASSE 1061 AMSE A112.18.6 CSA B125.6

SIZE	ITEM#	CTN/CASE	CASE WT
Push			200 PSI/200°F Max
1/2" × 1/4"	H-26920WKIT-B	12/72	41
1/2" × 3/8"	H-26921WKIT-B	12/72	41
3/4" × 1/4"	H-26930WKIT-B	6/60	54

PRO-CONNECT PROPUSH REMOVAL TOOL

SIZE	ITEM#	CTN/CASE	CASE WT
1/4"	H-28110-B	24/1200	10
3/8"	H-28111-B	24/1200	9
1/2"	H-28112	1/300	3
3/4"	H-28113	1/300	5
1"	H-28114	1/250	6
1 1/4"	H-28115-B	1/50	1
1 1/2"	H-28116-B	1/50	1
2"	H-28117-B	1/50	1



1 1/4" - 2"

PRO-CONNECT PROPUSH ADAPTER SET

SIZE	ITEM#	CTN/CASE	CASE WT
1/2"	H-28212	1/300	1
3/4"	H-28213	1/300	1
1"	H-28214	1/250	4
1 1/4"	H-28215-B	1/100	5
1 1/2"	H-28216-B	1/100	8
2"	H-28217-B	1/100	13



1 1/4" - 2"

PRO-CONNECT PROPUSH DEBURR & GAUGE TOOL

SIZE	ITEM#	BAG/CASE	CASE WT
1/4" - 1"	H-28000-B	1/50	7



PRO-CONNECT PROPUSH STRAIGHT COUPLING

Forged DZR Brass Fitting · For Connection to Copper, CPVC or PEX

LEAD-FREE BRASS
 Certified to NSF/ANSI 61 & 372
 ASSE 1061

SIZE	ITEM#	CTN/CASE	CASE WT
STRAIGHT COUPLING			
Push 200 PSI/200°F Max			
1/4"	H-26100W-B	6/600	33
1/4" x 1/2"	H-26120W-B	6/150	15
3/8"	H-26101W	25/250	24
3/8" x 1/2"	H-26112W	25/250	29
1/2"	H-26102W	25/250	31
3/4"	H-26103W	10/100	21
3/4" x 1/2"	H-26132W	15/150	27
1"	H-26104W	9/90	29
1" x 3/4"	H-26143W	9/90	24
1 1/4"	H-26105W-B	1/30	26
1 1/4" x 1"	H-26154W-B	1/30	19
1 1/2"	H-26106W-B	1/27	39
1 1/2" x 1 1/4"	H-26165W-B	1/20	23
2"	H-26107W-B	1/20	38
2" x 1 1/2"	H-26176W-B	1/15	26

FEMALE STRAIGHT CONNECTOR

SIZE	ITEM#	CTN/CASE	CASE WT
Push x FIP 200 PSI/200°F Max			
1/4" x 1/2"	H-26220W-B	6/180	21
3/8" x 1/2"	H-26212W-B	6/180	20
1/2"	H-26202W	20/200	25
1/2" x 3/4"	H-26223W	20/200	33
3/4"	H-26203W	12/120	25
3/4" x 1/2"	H-26232W-B	6/180	24
3/4" x 1"	H-26234W-B	6/90	23
1"	H-26204W	9/90	25
1 1/4"	H-26205W-B	1/30	22
1 1/2"	H-26206W-B	1/25	27
2"	H-26207W-B	1/20	30

MALE STRAIGHT CONNECTOR

SIZE	ITEM#	CTN/CASE	CASE WT
Push x MIP 200 PSI/200°F Max			
1/4" x 1/2"	H-26320W-B	6/180	19
1/2"	H-26302W	20/200	23
1/2" x 3/4"	H-26323W	20/200	35
3/4"	H-26303W	15/150	28
3/4" x 1/2"	H-26332W-B	6/150	21
3/4" x 1"	H-26334W-B	6/90	25
1"	H-26304W	9/90	24
1" x 3/4"	H-26343W	9/90	22
1 1/4"	H-26305W-B	1/30	23
1 1/2"	H-26306W-B	1/25	25
2"	H-26307W-B	1/20	28

PRO-CONNECT PROPUSH 90 DEGREE ELBOW

Forged DZR Brass Fitting · For Connection to Copper, CPVC or PEX

LEAD-FREE BRASS
 Certified to NSF/ANSI 61 & 372
 ASSE 1061

SIZE	ITEM#	CTN/CASE	CASE WT
Push 200 PSI/200°F Max			
1/4"	H-26400W-B	6/360	26
3/8"	H-26401W-B	6/180	23
1/2"	H-26402W	20/200	31
1/2" x 3/8"	H-26421W-B	12/180	28
3/4"	H-26403W	12/120	33
3/4" x 1/2"	H-26432W	12/120	25
1"	H-26404W	10/100	48
1" x 3/4"	H-26443W-B	3/60	24
1 1/4"	H-26405W-B	1/20	23
1 1/2"	H-26406W-B	1/15	28
2"	H-26407W-B	1/8	22
Push x FIP 200 PSI/200°F Max			
1/2"	H-26422W	20/200	31
Push x MIP 200 PSI/200°F Max			
1/2"	H-26222W	20/200	31
3/4"	H-26233W-B	6/90	27

PRO-CONNECT PROPUSH 90 DEGREE DROP EAR ELBOW

Forged DZR Brass Fitting · For Connection to Copper, CPVC or PEX

LEAD-FREE BRASS
 Certified to NSF/ANSI 61 & 372
 ASSE 1061

SIZE	ITEM#	CTN/CASE	CASE WT
Push x FIP 200 PSI/200°F Max			
1/2"	H-26412W	9/90	21
3/4"	H-26413W-B	6/90	33
Push 200 PSI/200°F Max			
1/2"	H-26462W	9/90	21

PRO-CONNECT PROPUSH 90 DEGREE HY-EAR ELBOW

Forged DZR Brass Fitting · For Connection to Copper, CPVC or PEX

LEAD-FREE BRASS
 Certified to NSF/ANSI 61 & 372
 ASSE 1061

SIZE	ITEM#	CTN/CASE	CASE WT
Push x FIP 200 PSI/200°F Max			
1/2"	H-26412WHE-B	6/120	32

PRO-CONNECT PROPUSH TEE

Forged DZR Brass Fitting · For Connection to Copper, CPVC or PEX

LEAD-FREE BRASS
 Certified to NSF/ANSI 61 & 372
 ASSE 1061

SIZE	ITEM#	CTN/CASE	CASE WT
Push 200 PSI/200°F Max			
1/4"	H-26500W-B	6/300	22
3/8"	H-26501W-B	6/150	26
3/8" x 3/8" x 1/2"	H-26512W-B	6/120	22
1/2"	H-26502W	12/120	25
1/2" x 1/2" x 1/4"	H-26520W-B	6/120	22
1/2" x 1/2" x 3/8"	H-26521W-B	6/120	25
3/4"	H-26503W	12/120	43
3/4" x 1/2" x 1/2"	H-26522W	18/180	44
3/4" x 3/4" x 1/2"	H-26532W	15/150	48
3/4" x 1/2" x 3/4"	H-26533W	12/120	39
1"	H-26504W	6/60	38
1" x 1" x 3/4"	H-26543W	6/60	30
1 1/4"	H-26505W-B	1/15	24
1 1/2"	H-26506W-B	1/10	25
2"	H-26507W-B	1/6	22

PRO-CONNECT PROPUSH SLIP COUPLING

Forged DZR Brass Fitting · For Connection to Copper, CPVC or PEX

LEAD-FREE BRASS
 Certified to NSF/ANSI 61 & 372
 ASSE 1061

SIZE	ITEM#	CTN/CASE	CASE WT
Push 200 PSI/200°F Max			
1/2"	H-26122W	15/150	34
3/4"	H-26133W	5/50	19
1"	H-26144W	5/50	27

PRO-CONNECT PROPUSH END CAP

Forged DZR Brass Fitting · For Connection to Copper, CPVC or PEX

LEAD-FREE BRASS
 Certified to NSF/ANSI 61 & 372
 ASSE 1061

SIZE	ITEM#	CTN/CASE	CASE WT
Push 200 PSI/200°F Max			
3/8"	H-26601W-B	6/300	21
1/2"	H-26602W	30/300	22
3/4"	H-26603W	20/200	23
1"	H-26604W	12/120	24
1 1/4"	H-26605W-B	1/40	20
1 1/2"	H-26606W-B	1/35	28
2"	H-26607W-B	1/30	34

PRO-CONNECT PROPUSH POLYBUTYLENE ADAPTER

Forged DZR Brass Fitting · For Connection to Copper, CPVC or PEX

LEAD-FREE BRASS
 Certified to NSF/ANSI 61 & 372
 ASSE 1061

SIZE	ITEM#	CTN/CASE	CASE WT
Push x Push PB 200 PSI/200°F Max			
1/2"	H-26192W-B	6/120	17
3/4"	H-26193W-B	6/90	18

PRO-CONNECT PROPUSH REPAIR TEE

Forged DZR Brass Fitting · For Connection to Copper, CPVC or PEX

LEAD-FREE BRASS
 Certified to NSF/ANSI 61 & 372
 ASSE 1061

SIZE	ITEM#	CTN/CASE	CASE WT
Push 200 PSI/200°F Max			
1/2"	H-26702W	8/80	26
3/4"	H-26703W	6/60	32
Push x Push x FIP 200 PSI/200°F Max			
1/2"	H-26722W	8/80	27
3/4"	H-26733W	6/60	33
Push x Push x CTS Slip 200 PSI/200°F Max			
1/2"	H-26752W-B	6/60	19

EXCLUSIVE WEBSTONE PRODUCTS NOW WITH PRESS CONNECTIONS

- Saves time, space, & labor
- Items available in sizes 1/2" to 4"
- Compatible with popular press tools

UNDER BOILER SOLUTIONS



The ISOLATOR
UNI-FLANGE BALL VALVE®



BALL VALVES



TWH SERVICE VALVES
E·X·P
SERIES



HYDRO-CORE



TEMPERATURE CONTROL

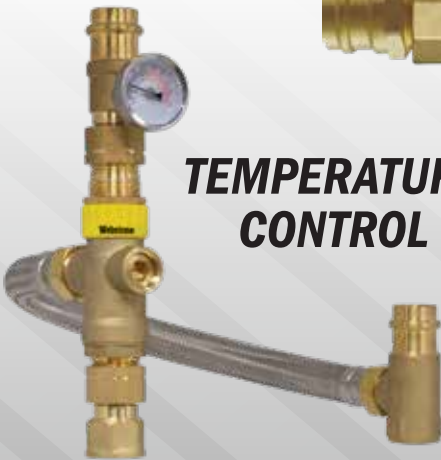

TRANSITION FITTINGS



PRO-PAL
SERIES



THE BROADEST SELECTION OF PRESS VALVES AND FITTINGS AVAILABLE ANYWHERE

BALL VALVES

PATENTS PENDING

FULL PORT FORGED BRASS BALL VALVE

w/ Adjustable Packing Gland

STANDARD BRASS

Certified to NSF/ANSI 61-8

LEAD-FREE BRASS

Certified to NSF/ANSI 61 NSF/ANSI 61-8

SIZE	ITEM#	CTN/CASE	CASE WT	ITEM#	CTN/CASE	CASE WT
FIP						
w/ Chrome-Plated Lever Handle 600 PSI CWP Max/150 WSP(400 PSI CWP Max/125 WSP 2½-4")						
1/4"	H-41700	10/100	27	H-41700W	10/100	27
3/8"	H-41701	10/100	29	H-41701W	10/100	29
1/2"	H-41702	10/80	32	H-41702W	10/80	31
3/4"	H-41703	10/60	35	H-41703W	10/60	35
1"	H-41704	6/36	39	H-41704W	6/36	38
1 1/4"	H-41705	6/24	35	H-41705W	6/24	35
1 1/2"	H-41706	2/16	36	H-41706W	2/16	36
2"	H-41707	2/12	38	H-41707W	2/12	38
2 1/2"	H-41708	1/6	43	H-41708W	1/6	45
3"	H-41709	1/4	37	H-41709W	1/4	36
4"	H-41710	1/2	31	H-41710W	1/2	30

w/ 304 Stainless Steel Handle

600 PSI CWP Max/150 WSP						
1/2"	H-41702SSL	10/80	31	H-41702WSSL	10/80	31
3/4"	H-41703SSL	10/60	35	H-41703WSSL	10/60	36
1"	H-41704SSL	6/36	39	H-41704WSSL	6/36	39
1 1/4"	H-41705SSL	6/24	34	H-41705WSSL	6/24	34
1 1/2"	H-41706SSL	2/16	40	H-41706WSSL	2/16	36
2"	H-41707SSL	2/12	38	H-41707WSSL	2/12	38

w/ Wing Style "T" Handle

600 PSI CWP Max/150 WSP						
1/2"	H-41702T	10/80	33	H-41702WT	10/80	33
3/4"	H-41703T	10/60	35	H-41703WT	10/60	38
1"	H-41704T	6/36	44	H-41704WT	6/36	40

w/ 304 Stainless Steel Wing Style "T" Handle

600 PSI CWP Max/150 WSP						
1/2"	H-41702SSW	10/80	39	H-41702WSSW	10/80	39
3/4"	H-41703SSW	10/60	36	H-41703WSSW	10/60	36
1"	H-41704SSW	6/48	55	H-41704WSSW	6/48	52

STANDARD BRASS

Certified to NSF/ANSI 61-8

LEAD-FREE BRASS

Certified to NSF/ANSI 61 NSF/ANSI 61-8

SIZE	ITEM#	CTN/CASE	CASE WT	ITEM#	CTN/CASE	CASE WT
SWT						
w/ Chrome-Plated Lever Handle 600 PSI CWP Max/150 WSP(400 PSI CWP Max/125 WSP 2½-4")						
1/2"	H-51702	10/80	27	H-51702W	10/80	26
3/4"	H-51703	10/60	33	H-51703W	10/60	33
1"	H-51704	6/36	35	H-51704W	6/36	35
1 1/4"	H-51705	6/24	33	H-51705W	6/24	32
1 1/2"	H-51706	2/16	36	H-51706W	2/16	41
2"	H-51707	2/12	38	H-51707W	2/12	38
2 1/2"	H-51708	1/8	54	H-51708W	1/6	39
3"	H-51709	1/3	26	H-51709W	1/4	34
4"	H-51710	1/2	36	H-51710W	1/2	42

w/ 304 Stainless Steel Handle

600 PSI CWP Max/150 WSP						
1/2"	H-51702SSL	10/80	26	H-51702WSSL	10/80	26
3/4"	H-51703SSL	10/60	33	H-51703WSSL	10/60	33
1"	H-51704SSL	6/36	34	H-51704WSSL	6/36	34
1 1/4"	H-51705SSL	6/24	31	H-51705WSSL	6/24	32
1 1/2"	H-51706SSL	2/24	53	H-51706WSSL	2/16	36
2"	H-51707SSL	2/12	38	H-51707WSSL	2/12	38

w/ Wing Style "T" Handle

600 PSI CWP Max/150 WSP						
1/2"	H-51702T	10/80	29	H-51702WT	10/80	27
3/4"	H-51703T	10/60	36	H-51703WT	10/60	34
1"	H-51704T	6/36	37	H-51704WT	6/36	35

w/ 304 Stainless Steel Wing Style "T" Handle

600 PSI CWP Max/150 WSP						
1/2"	H-51702SSW	10/80	42	H-51702WSSW	10/80	42
3/4"	H-51703SSW	10/60	43	H-51703WSSW	10/60	47
1"	H-51704SSW	6/36	42	H-51704WSSW	6/36	47

CERTIFICATIONS DO NOT APPLY TO 51708, 51708W, 51709, 51709W



AVAILABLE W/

PRO-CONNECT
PP-R
EXCLUSIVELY FOR

aquatherm
SEE PAGE 32



AVAILABLE W/

PRO-CONNECT
PP-R
FOR ANY
PP-R OR PP-RCT
PIPING SYSTEM

SEE PAGE 33



PRO-CONNECT PRO-PUSH BALL VALVE

Full Port Forged DZR Brass w/ Adjustable Packing Gland - For Connection to Copper, CPVC, or PEX

LEAD-FREE BRASS

Certified to NSF/ANSI 61 & 372 NSF/ANSI 14 ASSE 1061

SIZE	ITEM#	CTN/CASE	CASE WT
Push			
200 PSI/200°F Max			
1/2"	H-62702W	10/100	44
3/4"	H-62703W	10/100	63
1"	H-62704W	5/50	56



FULL FLOW FORGED DZR BRASS BALL VALVE

w/ Stainless Steel Wing Style "T" Handle & Adjustable Packing Gland

LEAD-FREE BRASS

Certified to NSF/ANSI 61 & 372 NSF/ANSI 14

SIZE	ITEM#	CTN/CASE	CASE WT
ASTM F1960 PEX			
400 PSI CWP Max/250°F Max			
1/2"	H-31702WSSW	10/80	27
3/4"	H-31703WSSW	10/60	30
1"	H-31704WSSW	6/36	33
1 1/4"	H-31705WSSW	5/25	33
1 1/2"	H-31706WSSW	5/25	49
2"	H-31707WSSW	2/12	38
ASTM F1807 PEX			
400 PSI CWP Max/250°F Max			
1/2"	H-11702WSSW	10/80	23
3/4"	H-11703WSSW	10/60	26
1"	H-11704WSSW	6/36	26



XLC CONNECTION
ON SIZES 2½- 4"

PRO-CONNECT PRESS FULL PORT FORGED BRASS BALL VALVE

w/ Adjustable Packing Gland

STANDARD BRASS

Certified to NSF/ANSI 61

LEAD-FREE BRASS

Certified to NSF/ANSI 61 & 372

SIZE	ITEM#	CTN/CASE	CASE WT	ITEM#	CTN/CASE	CASE WT
Press						
250 PSI CWP MAX/250°F MAX						
1/2"	H-81702	5/50	27	H-81702W	5/50	26
3/4"	H-81703	5/40	33	H-81703W	5/40	32
1"	H-81704	4/20	27	H-81704W	4/20	24
1 1/4"	H-81705	5/20	39	H-81705W	5/20	38
1 1/2"	H-81706	4/16	41	H-81706W	4/16	43
2"	H-81707	2/8	33	H-81707W	2/8	33
2 1/2"	-	-	-	H-81708W	1/1	9
3"	-	-	-	H-81709W	1/1	12
4"	-	-	-	H-81710W	1/1	21

SEE PAGE 31 FOR A FULL SELECTION OF PEX TRANSITION BALL VALVES



BALL VALVES

FULL PORT NICKEL PLATED FORGED BRASS BALL VALVE

w/ 304 Stainless Steel Lever Handle & Adjustable Packing Gland

LEAD-FREE BRASS

Certified to NSF/ANSI 61-G

SIZE	ITEM#	CTN/CASE	CASE WT
FIP		600 PSI CWP MAX/150 WSP	
1/4"	H-40800W	20/120	43
3/8"	H-40801W	20/120	37
1/2"	H-40802W	20/120	54
3/4"	H-40803W	14/84	56
1"	H-40804W	8/48	53
1 1/4"	H-40805W	6/36	57
1 1/2"	H-40806W	4/24	59
2"	H-40807W	2/16	56



FULL PORT FORGED BRASS BALL VALVE

3 Way L-Port w/ Reversible Handle & Adjustable Packing Gland

STANDARD BRASS

SIZE	ITEM#	CTN/CASE	CASE WT
FIP		600 PSI CWP MAX/150 WSP	
1/2"	H-40642	15/60	34
3/4"	H-40643	10/40	34
1"	H-40644	6/24	35

FORGED BRASS BALL VALVE

w/ Compression Ends & Adjustable Packing Gland

LEAD-FREE BRASS

Certified to NSF/ANSI 61-G

SIZE	ITEM#	CTN/CASE	CASE WT
Compression		600 PSI CWP MAX/150 WSP	
1/2"	H-40632W	25/100	56
3/4"	H-40633W	15/60	51
1"	H-40634W	10/40	52

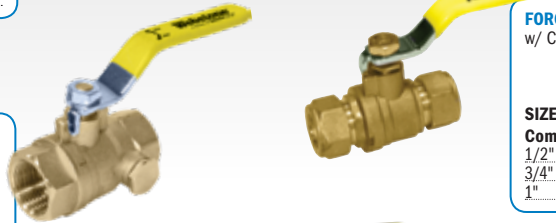

FULL PORT FORGED BRASS BALL VALVE

w/ 1/4" Threaded Gauge Hole (Plugged), Reversible Handle & Adjustable Packing Gland

STANDARD BRASS

SIZE	ITEM#	CTN/CASE	CASE WT
FIP		600 PSI CWP MAX/150 WSP	
1/2"	H-41722	10/80	43
3/4"	H-41723	10/60	43
1"	H-41724	6/48	56
1 1/4"	H-41725	4/32	56
1 1/2"	H-41726	2/24	64
2"	H-41727	2/16	61

STANDARD PORT FORGED BRASS BALL VALVE

w/ Adjustable Packing Gland

STANDARD BRASS

LEAD-FREE BRASS

Certified to NSF/ANSI 61-G

SIZE	ITEM#	CTN/CASE	CASE WT	ITEM#	CTN/CASE	CASE WT
FIP					600 PSI CWP MAX/125 WSP	
1/4"	H-41820	10/120	38	H-41820W	10/120	38
3/8"	H-41821	10/120	36	H-41821W	10/120	36
1/2"	H-41822	10/120	45	H-41822W	10/120	45
3/4"	H-41823	10/80	39	H-41823W	10/80	39
1"	H-41824	6/48	44	H-41824W	6/48	44
1 1/4"	H-41825	4/32	40	H-41825W	4/32	38
1 1/2"	H-41826	2/24	43	H-41826W	2/24	43
2"	H-41827	2/16	40	H-41827W	2/16	40
2 1/2"	H-41828	2/4	23	H-41828W	2/4	23
3"	H-41829	1/3	26	H-41829W	1/3	25
4"	H-41830	1/2	27	H-41830W	1/2	27



FORGED BRASS BALL VALVE

w/ Bleeder, Reversible Handle & Adjustable Packing Gland

LEAD-FREE BRASS

Certified to NSF/ANSI 61-G

SIZE	ITEM#	CTN/CASE	CASE WT
FIP		600 PSI CWP MAX/150 WSP	
1/2"	H-40622W	15/120	60
3/4"	H-40623W	12/48	36
1"	H-40624W	8/32	38
SWT		600 PSI CWP Max/150 WSP	
1/2"	H-50622W	25/100	49
3/4"	H-50623W	10/40	31
1"	H-50624W	6/24	29

MINI BALL VALVES

CHROME-PLATED EXTRUDED BRASS MINI BALL VALVE

Hex Body

STANDARD BRASS

SIZE	ITEM#	CTN/CASE	CASE WT
ASTM F1807 PEX		110 PSI CWP Max NON-SHOCK	
1/2"	H-40782	30/300	61

FULL PORT FORGED BRASS BALL VALVE

Pet Cock Style

STANDARD BRASS

SIZE	ITEM#	CTN/CASE	CASE WT
FIP x MIP		600 PSI CWP MAX/125 WSP	
1/8"	H-41685	10/100	19
1/4" x 1/8"	H-41686	10/100	10
1/4"	H-41687	10/100	18
FIP		600 PSI CWP Max/125 WSP	
1/8"	H-41698	10/100	18
1/4"	H-41699	10/100	17

FULL PORT FORGED BRASS BALL VALVE

w/ Reversible Handle & Adjustable Packing Gland

LEAD-FREE BRASS

SIZE	ITEM#	CTN/CASE	CASE WT
MIP x FIP		600 PSI CWP Max/150 WSP	
1/4"	H-40530W	12/96	35
3/8"	H-40531W	12/96	33
1/2"	H-40532W	12/96	45
3/4"	H-40533W	10/60	44
1"	H-40534W	6/48	55

FULL PORT FORGED BRASS BALL VALVE

w/ Cap & Strap, Reversible Handle & Adjustable Packing Gland

LEAD-FREE BRASS

Certified to NSF/ANSI 61-G

SIZE	ITEM#	CTN/CASE	CASE WT
FIP x Hose		600 PSI CWP MAX/150 WSP	
1/2" x 3/4"	H-40312W	10/60	30
3/4"	H-40313W	10/60	42
SWT x Hose		600 PSI CWP Max/150 WSP	
1/2" x 3/4"	H-50312W	10/100	49
3/4"	H-50313W	10/60	42

LEAD-FREE BRASS

Certified to NSF/ANSI 61 & 372

SIZE	ITEM#	CTN/CASE	CASE WT
Press x Hose		250 PSI CWP Max/250°F Max	
1/2" x 3/4"	H-80312W	5/50	29
3/4"	H-80313W	5/40	33

GAS BALL VALVES

FORGED BRASS GAS BALL VALVE

STANDARD BRASS

SIZE	ITEM#	CTN/CASE	CASE WT
FIP			UP TO 5 PSI
3/8"	H-22561	12/144	33
1/2"	H-22562	12/144	49
3/4"	H-22563	12/144	64
1"	H-22564	6/72	58

STAINLESS STEEL BALL VALVES



FULL PORT 316 STAINLESS STEEL BALL VALVE

2-Piece Investment Cast w/ 304 Stainless Steel Locking Handle & Adjustable Packing Gland

SIZE	ITEM#	CTN/CASE	CASE WT
FIP		1000 PSI CWP MAX/150 WSP	
1/4"	H-43720	2/80	43
3/8"	H-43721	2/80	39
1/2"	H-43722	2/60	45
3/4"	H-43723	2/40	45
1"	H-43724	2/40	68
1 1/4"	H-43725	2/30	80
1 1/2"	H-43726	2/16	64
2"	H-43727	2/10	52

W/ 304 STAINLESS STEEL OVAL HANDLE

SIZE	ITEM#	CTN/CASE	CASE WT
1/2"	H-43722-OH	1/40	35
3/4"	H-43723-OH	1/30	37
1"	H-43724-OH	1/20	37

STANDARD PORT 316 STAINLESS STEEL BALL VALVE

1-Piece Investment Cast w/ 304 Stainless Steel Locking Handle & Adjustable Packing Gland

SIZE	ITEM#	CTN/CASE	CASE WT
FIP		1000 PSI CWP MAX/150 WSP	
1/4"	H-43900	4/200	31
3/8"	H-43901	4/200	45
1/2"	H-43902	2/100	38
3/4"	H-43903	2/80	47
1"	H-43904	2/50	47
1 1/4"	H-43905	2/40	50
1 1/2"	H-43906	2/30	59
2"	H-43907	2/30	87

GATE VALVES

FORGED BRASS GATE VALVE

Hard Seat

STANDARD BRASS

SIZE	ITEM#	CTN/CASE	CASE WT
FIP		200 PSI CWP Max/125 WSP	
2"	H-10137	2/20	58
2 1/2"	H-10138	1/10	49
3"	H-10139	1/10	74
4"	H-10140	1/4	50

LEAD-FREE BRASS

Certified to NSF/ANSI 61-G

SIZE	ITEM#	CTN/CASE	CASE WT
FIP		200 PSI CWP Max/125 WSP	
1/2"	H-10132W	10/100	50
3/4"	H-10133W	10/100	71
1"	H-10134W	5/50	48
1 1/4"	H-10135W	5/30	52
1 1/2"	H-10136W	2/30	63
2"	H-10137W	2/20	58
2 1/2"	H-10138W	1/10	50
3"	H-10139W	1/10	73
4"	H-10140W	1/4	49



RADIATOR VALVES

BRASS STEAM RADIATOR GLOBE VALVE

Angled w/ Ground Joint Nut & Tailpiece

SIZE	ITEM#	CTN/CASE	CASE WT
FIP		60 PSI/15 WSP	
3/4"	H-11533	6/48	55
1"	H-11534	4/36	54
1 1/4"	H-11535	2/24	50
1 1/2"	H-11536	2/16	49



BRASS HOT WATER RADIATOR GLOBE VALVE

Angled w/ Ground Joint Union Nut & Tailpiece

SIZE	ITEM#	CTN/CASE	CASE WT
FIP		60 PSI	
3/4"	H-11553	6/60	51
1"	H-11554	4/36	49
1 1/4"	H-11555	2/24	51
1 1/2"	H-11556	2/16	40



BRASS UNION ELBOW & NUT FOR RADIATOR VALVE

Ground Joint Union Connection

SIZE	ITEM#	CTN/CASE	CASE WT
FIP x MIP		60 PSI/15 WSP	
3/4"	H-11533-E	10/100	58
1"	H-11534-E	7/70	65
1 1/4"	H-11535-E	5/50	71



BRASS UNION TAILPIECE & NUT FOR RADIATOR VALVE

Ground Joint Nut & Tailpiece

SIZE	ITEM#	CTN/CASE	CASE WT
FIP x MIP		60 PSI/15 WSP	
3/4"	H-11533-T	22/220	69
1"	H-11534-T	16/160	71
1 1/4"	H-11535-T	10/100	67



BOILER DRAINS

BRASS BOILER DRAIN

LEAD-FREE BRASS

SIZE	ITEM#	CTN/CASE	CASE WT
MIP x Hose		200 PSI	
1/2"	H-11702W	12/72	28
3/4"	H-11703W	12/72	31



BRASS BOILER DRAIN

w/ Stuffing Box

LEAD-FREE BRASS

SIZE	ITEM#	CTN/CASE	CASE WT
MIP x Hose		200 PSI	
1/2"	H-11704W	12/72	33
3/4"	H-11705W	12/72	33



BRASS WATER HEATER DRAIN VALVE

LEAD-FREE BRASS

SIZE	ITEM#	CTN/CASE	CASE WT
MIP x Hose		125 PSI	
3/4"	H-11710W	12/72	42



BRASS WATER HEATER DRAIN VALVE

w/ Recirculating Elbow (Tan Handle)

LEAD-FREE BRASS

SIZE	ITEM#	CTN/CASE	CASE WT
FIP x FIP x Hose		125 PSI	
3/4"	H-11711W	12/72	47

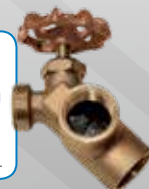

CHECK VALVES

B62 BRONZE (85-5-5) SWING CHECK VALVE

Hard Seat



SIZE	ITEM#	CTN/CASE	CASE WT
FIP		300 PSI CWP MAX/150 WSP	
3/8"	H-10501	10/120	53
1/2"	H-10502	10/120	54
3/4"	H-10503	10/80	51
1"	H-10504	5/60	49
1 1/4"	H-10505	5/40	59
1 1/2"	H-10506	5/30	56
2"	H-10507	2/24	68
2 1/2"	H-10508	1/12	56
3"	H-10509	1/8	59
4"	H-10510	1/4	43

FORGED BRASS SWING CHECK VALVE

Hard Seat



LEAD-FREE BRASS

Certified to NSF/ANSI 61-G

SIZE	ITEM#	CTN/CASE	CASE WT
FIP		200 PSI CWP MAX/125 WSP	
1/4"	H-10540W	12/120	27
3/8"	H-10541W	10/120	35
1/2"	H-10542W	10/120	49
3/4"	H-10543W	10/80	49
1"	H-10544W	5/60	51
1 1/4"	H-10545W	5/40	56
1 1/2"	H-10546W	5/30	60
2"	H-10547W	2/12	34
2 1/2"	H-10548W	2/8	38
3"	H-10549W	1/8	61
4"	H-10550W	1/4	47
SWT		200 PSI CWP Max/125 WSP	
1/2"	H-10622W	10/120	50
3/4"	H-10623W	10/80	51
1"	H-10624W	5/60	54
1 1/4"	H-10625W	5/40	59
1 1/2"	H-10626W	5/30	63
2"	H-10627W	2/10	31

FORGED BRASS SWING CHECK VALVE

Soft Seat



STANDARD BRASS

SIZE	ITEM#	CTN/CASE	CASE WT
FIP		200 PSI CWP MAX/125 WSP	
1/2"	H-10522	12/120	50
3/4"	H-10523	10/80	47
1"	H-10524	5/60	47
1 1/4"	H-10525	5/40	55
1 1/2"	H-10526	5/30	56
2"	H-10527	2/24	64

SILLCOCKS

FULL FLOW FORGED NICKEL-PLATED BRASS SILLCOCK

1/4 Turn Action w/ Stainless Steel Lever Handle



LEAD-FREE BRASS

SIZE	ITEM#	CTN/CASE	CASE WT
ASTM F1960 PEX Flange x MIP Hose		125 PSI CWP MAX	
1/2"	H-33202WSSL	12/72	58

FORGED BRASS SILLCOCK

Nickel-Plated w/ 1/4 Turn Handle



LEAD-FREE BRASS

SIZE	ITEM#	CTN/CASE	CASE WT
FIP Flange x Hose		125 PSI CWP MAX	
1/2"	H-30202W	12/72	43
3/4"	H-30203W	12/72	59

FORGED DZR BRASS IN-LINE SPRING CHECK VALVE

Stainless Steel Spring - Soft Seat (FKM)



LEAD-FREE BRASS

Certified to NSF/ANSI 61 & 372

SIZE	ITEM#	CTN/CASE	CASE WT
FIP		200 PSI CWP Max / 250°F Max	
3/8"	H-10741W	10/100	19
1/2"	H-10742W	10/100	30
3/4"	H-10743W	10/60	31
1"	H-10744W	10/40	29
1 1/4"	H-10745W	6/24	24
1 1/2"	H-10746W	6/24	29
2"	H-10747W	6/12	22
SWT		200 PSI CWP Max / 250°F Max	
3/8"	H-10751W	10/100	19
1/2"	H-10752W	10/100	30
3/4"	H-10753W	10/60	31
1"	H-10754W	10/40	29
1 1/4"	H-10755W	6/24	24
1 1/2"	H-10756W	6/24	29
2"	H-10757W	6/12	22



PRO-CONNECT PRO-PUSH IN-LINE SPRING CHECK VALVE

Forged DZR Brass Fitting

LEAD-FREE BRASS

Certified to NSF/ANSI 61 & 372
ASSE 1061

SIZE	ITEM#	CTN/CASE	CASE WT
Push		200 PSI/200°F MAX	
1/2"	H-26992W-B	6/120	20
3/4"	H-26993W	12/120	39
1"	H-26994W-B	3/45	25

UNIONS

DIELECTRIC UNION

Galvanized Steel & Brass - w/ Nylon Insulator Ring



LEAD-FREE BRASS

SIZE	ITEM#	CTN/CASE	CASE WT
FIP x SWT			232°F Max
1/2"	H-01102W	24/144	46
3/4"	H-01103W	24/96	39
1"	H-01104W	12/96	53
1 1/4"	H-01105W	6/48	42
1 1/2"	H-01106W	6/36	50
2"	H-01107W	6/18	45
3/4" x 1/2"	H-01132W	24/96	37

HOSE BIBBS



FORGED BRASS HOSE BIBB

w/ Ball Valve Action

LEAD-FREE BRASS

Certified to NSF/ANSI 61-G

SIZE	ITEM#	CTN/CASE	CASE WT
MIP x Hose		125 PSI CWP MAX	
1/2"	H-30314W	12/72	35
3/4"	H-30316W	12/72	39

1/2" MIP OR SWT x HOSE

BRASS HOSE BIBB

No Kink w/ 1/4 Turn Handle

LEAD-FREE BRASS

Certified to NSF/ANSI 61-G

SIZE	ITEM#	CTN/CASE	CASE WT
MIP x Hose		125 PSI CWP MAX	
1/2"	H-30218W	12/72	23
3/4"	H-30219W	12/72	26

1/2" MIP OR SWT x HOSE



INDEX

PART NUMBER	PAGE	PART NUMBER	PAGE	PART NUMBER	PAGE	PART NUMBER	PAGE	PART NUMBER	PAGE	PART NUMBER	PAGE
H-4CC4-NBHK	16	H-10423W-RB	11, 31	H-11704WSSW	30, 37	H-26343W	35	H-30612W	22, 30	H-40612W	22
H-4CC4-NBHK-E3	16	H-10424W	23, 30	H-11705W	39	H-26400W-B	35	H-30613W	22, 30	H-40613	22
H-4CCL54-54Y	16	H-10432W	23, 30	H-11710W	39	H-26401W-B	35	H-30614W	22, 30	H-40613W	22
H-4FK4R3-WIF-E3	16	H-10433W	23, 30	H-11711W	39	H-26402W	35	H-30615W	22, 30	H-40614	22
H-4FK4-WIF	16	H-10434W	23, 30	H-13703HV	27	H-26403W	35	H-30616W	22, 30	H-40614W	22
H-4FK5-CH	16	H-10435W	23, 30	H-13706HV	27	H-26404W	35	H-30617W	22, 30	H-40615	22
H-5CC4-NBHK	16	H-10436W	23, 30	H-14063W	11, 31	H-26405W-B	35	H-31000	17	H-40615W	22
H-5CC4-NBHK-E3	16	H-10437W	23, 30	H-14443W	11, 31	H-26406W-B	35	H-31403W	26, 30	H-40616	22
H-5CCL54-54Y	16	H-10501	40	H-14443WPR	11, 31	H-26407W-B	35	H-31403WHV	26, 30	H-40616W	22
H-5FK4R3-WIF-E3	16	H-10502	40	H-14702WSSW	31	H-26412W	35	H-31404W	26, 30	H-40617	22
H-5FK4-WIF	16	H-10503	40	H-14703WSSW	31	H-26412WHE-B	35	H-31404WHV	26, 30	H-40617W	22
H-5FK5-CH	16	H-10504	40	H-14704WSSW	31	H-26413W-B	35	H-31413W	26, 30	H-40622W	38
H-7-1102W WP	7	H-10505	40	H-16802W	31	H-26421W-B	35	H-31413WHV	26, 30	H-40623W	38
H-7-1103W WP	7	H-10506	40	H-16803W	31	H-26422W	35	H-31414W	26, 30	H-40624W	38
H-7-1202W WP	7	H-10507	40	H-16804W	31	H-26432W	35	H-31414WHV	26, 30	H-40632W	38
H-7-1203W WP	7	H-10508	40	H-16805W	31	H-26443W-B	35	H-31702WSSW	30, 37	H-40633W	38
H-7-2102W WP	7	H-10509	40	H-16806W	31	H-26462W	35	H-31703WSSW	30, 37	H-40634W	38
H-7-2103W WP	7, 19	H-10510	40	H-16807W	31	H-26500W-B	35	H-31704WSSW	30, 37	H-40642	38
H-7-2104W WP	7, 19	H-10522	40	H-16842W	31	H-26501W-B	35	H-31705WSSW	30, 37	H-40643	38
H-7-2202W WP	7	H-10523	40	H-16843W	31	H-26502W	35	H-31706WSSW	30, 37	H-40644	38
H-7-2203W WP	7	H-10524	40	H-16844W	31	H-26503W	35	H-31707WSSW	30, 37	H-40782	30, 38
H-7-2204W WP	7	H-10525	40	H-16845W	31	H-26504W	35	H-32000W	7, 19	H-40800W	38
H-7-3102W WP	7	H-10526	40	H-16846W	31	H-26505W-B	35	H-33000W	8	H-40801W	38
H-7-3103W WP	7	H-10527	40	H-16847W	31	H-26506W-B	35	H-33202WSSL	30, 40	H-40802W	38
H-7-3202W WP	7	H-10540W	40	H-20713	12	H-26507W-B	35	H-34063W	11, 31	H-40803W	38
H-7-3203W WP	7	H-10541W	40	H-20713W	12	H-26512W-B	35	H-34443W	11, 31	H-40804W	38
H-7-4102W WP	7	H-10542W	40	H-20723-CN	12	H-26520W-B	35	H-34443WPR	11, 31	H-40805W	38
H-7-4103W WP	7, 19	H-10543W	40	H-20733	12	H-26521W-B	35	H-34702WSSW	31	H-40806W	38
H-7-4104W WP	7, 19	H-10544W	40	H-22561	38	H-26522W	35	H-34703WSSW	31	H-40807W	38
H-7-4202W WP	7	H-10545W	40	H-22562	38	H-26532W	35	H-34704WSSW	31	H-41403	26
H-7-4203W WP	7	H-10546W	40	H-22563	38	H-26533W	35	H-36802W	31	H-41403HV	26
H-7-4204W WP	7	H-10547W	40	H-22563-24	12	H-26543W	35	H-36803W	31	H-41403W	26
H-7-5102W WP	7	H-10548W	40	H-22563-24-ADPT	12	H-26601W-B	35	H-36804W	31	H-41403WHV	26
H-7-5103W WP	7, 19	H-10549W	40	H-22564	38	H-26602W	35	H-36805W	31	H-41404	26
H-7-5104W WP	7, 19	H-10550W	40	H-26000WKIT	34	H-26603W	35	H-36806W	31	H-41404HV	26
H-7-5202W WP	7	H-10612W	22, 30	H-26023W-12-B	34	H-26604W	35	H-36807W	31	H-41404W	26
H-7-5203W WP	7	H-10613W	22, 30	H-26023W-15-B	34	H-26605W-B	35	H-36842W	31	H-41404WHV	26
H-7-5204W WP	7	H-10614W	22, 30	H-26023W-18	34	H-26606W-B	35	H-36843W	31	H-41405	26
H-7-6102W WP	7	H-10615W	22, 30	H-26023W-24-B	34	H-26607W-B	35	H-36844W	31	H-41405HV	26
H-7-6103W WP	7	H-10616W	22, 30	H-26033W-12	34	H-26702W	35	H-36845W	31	H-41405W	26
H-7-6202W WP	7	H-10617W	22, 30	H-26033W-15	34	H-26703W	35	H-36846W	31	H-41405WHV	26
H-7-6203W WP	7	H-10622W	40	H-26033W-18	34	H-26722W	35	H-36847W	31	H-41406	26
H-7-8102W WP	7	H-10623W	40	H-26033W-24	34	H-26733W	35	H-40312W	38	H-41406HV	26
H-7-8103W WP	7, 19	H-10624W	40	H-26100W-B	35	H-26752W-B	35	H-40313W	38	H-41406HV-RF375	28
H-7-8104W WP	7, 19	H-10625W	40	H-26101W	35	H-26820W	34	H-40402	27	H-41406W	26
H-7-8202W WP	7	H-10626W	40	H-26102W	35	H-26821W	34	H-40403	27	H-41406WHV	26
H-7-8203W WP	7	H-10627W	40	H-26103W	35	H-26920W	34	H-40404	27	H-41407HV-RF400	28
H-7-8204W WP	7	H-10741W	40	H-26104W	35	H-26920WKIT-B	34	H-40404HV	27	H-41407HV-RF475	28
H-7-G134WY	7, 19	H-10742W	40	H-26105W-B	35	H-26921W	34	H-40405	27	H-41407WHV	26
H-7-G134WY-A	7, 19	H-10743W	40	H-26106W-B	35	H-26921WKIT-B	34	H-40405HV	27	H-41413	26
H-7-G144W-A	7, 19	H-10744W	40	H-26107W-B	35	H-26930WKIT-B	34	H-40406	27	H-41413HV	26
H-7-G234W-A-KITA	7	H-10745W	40	H-26112W	35	H-26992W-B	34, 40	H-40406HV	27	H-41413HVKIT	27
H-7-G234W-A-KITB	7	H-10746W	40	H-26120W-B	35	H-26993W	34, 40	H-40407HV	27	H-41413KIT	27
H-7-G234WB	7	H-10747W	40	H-26122W	35	H-26994W-B	34, 40	H-40413	27	H-41413W	26
H-7-G234WB-A	7	H-10751W	40	H-26132W	35	H-28000-B	34	H-40413HV	27	H-41413WHV	26
H-7-G234W-KITA	7	H-10752W	40	H-26133W	35	H-28023W	12	H-40413HVKIT	27	H-41413WHVKIT	27
H-7-G234W-KITB	7	H-10753W	40	H-26143W	35	H-28110-B	34	H-40413KIT	27	H-41413WKIT	27
H-7-G234W-KITD	7	H-10754W	40	H-26144W	35	H-28111-B	34	H-40414	27	H-41414	26
H-7-G234WR	7	H-10755W	40	H-26154W-B	35	H-28112	34	H-40414HV	27	H-41414HV	26
H-7-G234WR-A	7	H-10756W	40	H-26165W-B	35	H-28113	34	H-40414HVKIT	27	H-41414HVKIT	27
H-8CC4-NBHK	16	H-10757W	40	H-26176W-B	35	H-28114	34	H-40414KIT	27	H-41414KIT	27
H-8CC4-NBHK-E3	16	H-11403W	26, 30	H-26192W-B	35	H-28115-B	34	H-40415	27	H-41414W	26
H-8CCL54-54Y	16	H-11403WHV	26, 30	H-26193W-B	35	H-28116-B	34	H-40415HV	27	H-41414WHV	26
H-8FK4R3-WIF-E3	16	H-11404W	26, 30	H-26202W	35	H-28117-B	34	H-40415HVKIT	27	H-41414WHVKIT	27
H-8FK4-WIF	16	H-11404WHV	26, 30	H-26203W	35	H-28212	34	H-40415KIT	27	H-41414WKIT	27
H-8FK5-CH	16	H-11413W	26, 30	H-26203WKIT	34	H-28213	34	H-40416	27	H-41415	26
H-01102W	40	H-11413WHV	26, 30	H-26204W	35	H-28214	34	H-40416HV	27	H-41415HV	26
H-01103W	40	H-11414W	26, 30	H-26205W-B	35	H-28215-B	34	H-40417HV	27	H-41415HVKIT	27
H-01104W	40	H-11414WHV	26, 30	H-26206W-B	35	H-28216-B	34	H-40422W	23	H-41415KIT	27
H-01105W	40	H-11533	39	H-26207W-B	35	H-28217-B	34	H-40423W	23	H-41415W	26
H-01106W	40	H-11533-E	39	H-26212W-B	35	H-30000W-P	12	H-40423W-RB	11	H-41415WHV	26
H-01107W	40	H-11533-T	39	H-26220W-B	35	H-30000W-TP	12	H-40424W	23	H-41415WHVKIT	27
H-01132W	40	H-11534	39	H-26222W	35	H-30202W	40	H-40433	23	H-41415WKIT	27
H-10132W	39	H-11534-E	39	H-26223W	35	H-30203W	40	H-40433W	23	H-41416	26
H-10133W	39	H-11534-T	39	H-26223WKIT	34	H-30218W	40	H-40434	23	H-41416HV	26
H-10134W	39	H-11535	39	H-26232W-B	35	H-30219W	40	H-40434W	23	H-41416HV-RF375	28
H-10135W	39	H-11535-E	39	H-26233W-B	35	H-30314W	40	H-40435	23	H-41416W	26
H-10136W	39	H-11535-T	39	H-26234W-B	35	H-30316W	40	H-40435W	23	H-41416WHV	26
H-10137	39	H-11536	39	H-26302W	35	H-30422W	23, 30	H-40436	23	H-41417HV-RF400	28
H-10137W	39	H-11553	39	H-26303W	35	H-30423W	23, 30	H-40436W	23	H-41417HV-RF475	28
H-10138	39	H-11554	39	H-26304W	35	H-30423W-RB	11, 31	H-40443W	11	H-41417WHV	26
H-10138W	39	H-11555	39	H-26305W-B	35	H-30424W	23, 30	H-40443WPR	11	H-41672	25
H-10139	39	H-11556	39	H-26306W-B	35	H-30432W	23, 30	H-40530W	38	H-41685	38
H-10139W	39	H-11702W	39	H-26307W-B	35	H-30433W	23, 30	H-40531W	38	H-41686	38
H-10140	39	H-11702WSSW	30, 37	H-26320W-B	35	H-30434W	23, 30	H-40532W	38	H-41687	38
H-10140W	39	H-11703W	39	H-26323W	35	H-30435W	23, 30	H-40533W	38	H-41698	38
H-10422W	23, 30	H-11703WSSW	30, 37	H-26332W-B	35	H-30436W	23, 30	H-40534W	38	H-41699	38
H-10423W	23, 30	H-11704W	39	H-26334W-B	35	H-30437W	23, 30	H-40612	22	H-41700	37

INDEX

PART NUMBER	PAGE	PART NUMBER	PAGE	PART NUMBER	PAGE	PART NUMBER	PAGE	PART NUMBER	PAGE	PART NUMBER	PAGE
H-41700W	37	H-43902	39	H-50624W	38	H-51706	37	H-72273W	6	H-77411W	8
H-41701	37	H-43903	39	H-50672W	24	H-51706SSL	37	H-72274W	6	H-77411W-TG	8
H-41701W	37	H-43904	39	H-50673W	24	H-51706W	37	H-72533	19	H-77610W	8
H-41702	37	H-43905	39	H-50674W	24	H-51706WSSL	37	H-72533-A	19	H-77610W-TG	8
H-41702SSL	37	H-43906	39	H-50675W	24	H-51707	37	H-72544	19	H-78003	21
H-41702SSW	37	H-43907	39	H-50676W	24	H-51707SSL	37	H-72544-A	19	H-78003-V	20
H-41702T	37	H-44063W	11	H-50677W	24	H-51707W	37	H-72703	18	H-78004	21
H-41702W	37	H-44443W	11	H-50682	31	H-51707WSSL	37	H-72704	18	H-78004-V	20
H-41702WSSL	37	H-44443WCOM	12	H-51403	26	H-51708	37	H-72713	18	H-78005	21
H-41702WSSW	37	H-44443WCOM-FP	12	H-51403HV	26	H-51708W	37	H-72714	18	H-78006	21
H-41702WT	37	H-44443WPR	11	H-51403W	26	H-51709	37	H-73202W-CE	6, 30	H-78007	21
H-41703	37	H-44443WPR-LF	11	H-51403WHV	26	H-51709W	37	H-73202W-CE-CAN	6, 30	H-78162W	6
H-41703SSL	37	H-44444	17	H-51404	26	H-51710	37	H-73203W-CE	6, 30	H-78163W	6
H-41703SSW	37	H-44444PR3	17	H-51404HV	26	H-51710W	37	H-73203W-CE-CAN	6, 30	H-78164W	6
H-41703T	37	H-44444W	11, 17	H-51404W	26	H-54063W	11	H-73272W	6, 30	H-78202W	6
H-41703T-24	12	H-44444WPR	11	H-51404WHV	26	H-54443W	11	H-73273W	6, 30	H-78202W-CAN	6
H-41703T-24-ADPT	12	H-44444WPR3	17	H-51405	26	H-54443WCOM	12	H-74000	21	H-78203W	6
H-41703W	37	H-44444WPR-LF	11	H-51405HV	26	H-54443WCOM-FP	12	H-74003	21	H-78203W-CAN	6
H-41703WSSL	37	H-44672	25	H-51405W	26	H-54443WPR	11	H-74003-V	20	H-78204W	6
H-41703WSSW	37	H-45443WPR	11	H-51405WHV	26	H-54443WPR-LF	11	H-74004	21	H-78204W-CAN	6
H-41703WT	37	H-45443WPR-LH	11	H-51406	26	H-54444W	11, 17	H-74004-V	20	H-78272W	6
H-41704	37	H-48354-43	15, 17	H-51406HV	26	H-54444WPR	11	H-74005	21	H-78273W	6
H-41704SSL	37	H-48354-44	15, 17	H-51406HV-RF375	28	H-54444WPR3	17	H-74006	21	H-78274W	6
H-41704SSW	37	H-48613	25	H-51406W	26	H-54444WPR-LF	11	H-74007	21	H-78313W	9
H-41704T	37	H-48614	25	H-51406WHV	26	H-54612	22	H-74162W	6	H-78323W	9
H-41704W	37	H-48615	25	H-51407HV-RF400	28	H-54612W	22	H-74163W	6	H-78533	19
H-41704WSSL	37	H-48616	25	H-51407HV-RF475	28	H-54613	22	H-74164W	6	H-78533-A	19
H-41704WSSW	37	H-48754-43	15, 17	H-51407WHV	26	H-54613W	22	H-74202W	6	H-78544	19
H-41704WT	37	H-48754-44	15, 17	H-51413	26	H-54614	22	H-74202W-CAN	6	H-78544-A	19
H-41705	37	H-48765-45	15, 17	H-51413HV	26	H-54614W	22	H-74203W	6	H-78703	18
H-41705SSL	37	H-48854-43	15, 17	H-51413HVKIT	27	H-55443WPR	11	H-74203W-CAN	6	H-78704	18
H-41705W	37	H-48854-44	15, 17	H-51413KIT	27	H-55443WPR-LH	11	H-74204W	6	H-78713	18
H-41705WSSL	37	H-48865-45	15, 17	H-51413W	26	H-58354-53	15, 17	H-74204W-CAN	6	H-78714	18
H-41706	37	H-50312W	38	H-51413WHV	26	H-58354-54	15, 17	H-74272W	6	H-80132W	31
H-41706SSL	37	H-50313W	38	H-51413WHVKIT	27	H-58613	25	H-74273W	6	H-80133W	31
H-41706W	37	H-50402	27	H-51413WKIT	27	H-58614	25	H-74274W	6	H-80134W	31
H-41706WSSL	37	H-50403	27	H-51414	26	H-58615	25	H-74303W	9	H-80135W	31
H-41707	37	H-50403HV	27	H-51414HV	26	H-58616	25	H-74303W-KITA	9	H-80136W	31
H-41707SSL	37	H-50404	27	H-51414HVKIT	27	H-58643	24	H-74303W-KITB	9	H-80137W	31
H-41707W	37	H-50404HV	27	H-51414KIT	27	H-58644	24	H-74313W	9	H-80312W	38
H-41707WSSL	37	H-50405	27	H-51414W	26	H-58653	24	H-74313W-KITA	9	H-80313W	38
H-41708	37	H-50405HV	27	H-51414WHV	26	H-58654	24	H-74313W-KITB	9	H-80332W	31
H-41708W	37	H-50406	27	H-51414WHVKIT	27	H-58655	24	H-74323W	9	H-80333W	31
H-41709	37	H-50406HV	27	H-51414WKIT	27	H-58754-53	15, 17	H-74533	19	H-80334W	31
H-41709W	37	H-50407HV	27	H-51415	26	H-58754-54	15, 17	H-74533-A	19	H-80335W	31
H-41710	37	H-50413	27	H-51415HV	26	H-58765-55	15, 17	H-74544	19	H-80336W	31
H-41710W	37	H-50413HV	27	H-51415HVKIT	27	H-58854-53	15, 17	H-74544-A	19	H-80337W	31
H-41722	38	H-50413HVKIT	27	H-51415KIT	27	H-58854-54	15, 17	H-74703	18	H-80422W	23
H-41723	38	H-50413KIT	27	H-51415W	26	H-58865-55	15, 17	H-74704	18	H-80423W	23
H-41724	38	H-50414	27	H-51415WHV	26	H-60422W	23	H-74713	18	H-80423W-RB	11
H-41725	38	H-50414HV	27	H-51415WHVKIT	27	H-60423W	23	H-74714	18	H-80424W	23
H-41726	38	H-50414HVKIT	27	H-51415WKIT	27	H-60424W	23	H-75003	21	H-80433W	23
H-41727	38	H-50414KIT	27	H-51416	26	H-62023W-18	34	H-75003-V	20	H-80434W	23
H-41820	38	H-50415	27	H-51416HV	26	H-62033W-18	34	H-75004	21	H-80435W	23
H-41820W	38	H-50415HV	27	H-51416HV-RF375	28	H-62702W	34, 37	H-75004-V	20	H-80436W	23
H-41821	38	H-50415HVKIT	27	H-51416W	26	H-62703W	34, 37	H-75005	21	H-80612	22
H-41821W	38	H-50415KIT	27	H-51416WHV	26	H-62704W	34, 37	H-75006	21	H-80612W	22
H-41822	38	H-50416	27	H-51417HV-RF400	28	H-64063W	11	H-75007	21	H-80613	22
H-41822W	38	H-50416HV	27	H-51417HV-RF475	28	H-64443W	11	H-75162W	6	H-80613W	22
H-41823	38	H-50417HV	27	H-51417WHV	26	H-64443WPR	11	H-75163W	6	H-80614	22
H-41823W	38	H-50422W	23	H-51702	37	H-70000W	6	H-75164W	6	H-80614W	22
H-41824	38	H-50423W	23	H-51702SSL	37	H-70000W-CAN	6	H-75202W	6	H-80615	22
H-41824W	38	H-50423W-RB	11	H-51702SSW	37	H-70060W	6	H-75202W-CAN	6	H-80615W	22
H-41825	38	H-50424W	23	H-51702T	37	H-70070W	6	H-75203W	6	H-80616W	22
H-41825W	38	H-50433	23	H-51702W	37	H-70530	19	H-75203W-CAN	6	H-80617W	22
H-41826	38	H-50433W	23	H-51702WSSL	37	H-70530-A	19	H-75204W	6	H-80672W	24
H-41826W	38	H-50434	23	H-51702WSSW	37	H-70540	19	H-75204W-CAN	6	H-80673W	24
H-41827	38	H-50434W	23	H-51702WT	37	H-70540-A	19	H-75272W	6	H-80674W	24
H-41827W	38	H-50435	23	H-51703	37	H-70700	18	H-75273W	6	H-80675W	24
H-41828	38	H-50435W	23	H-51703SSL	37	H-71000-V	20	H-75274W	6	H-81403	26
H-41828W	38	H-50436	23	H-51703SSW	37	H-71202W	6, 30	H-75533	19	H-81403HV	26
H-41829	38	H-50436W	23	H-51703T	37	H-71202W-CAN	6, 30	H-75533-A	19	H-81403W	26
H-41829W	38	H-50443W	11	H-51703W	37	H-71203W	6, 30	H-75544	19	H-81403WHV	26
H-41830	38	H-50443WPR	11	H-51703WSSL	37	H-71203W-CAN	6, 30	H-75544-A	19	H-81404	26
H-41830W	38	H-50612	22	H-51703WSSW	37	H-71272W	6, 30	H-75703	18	H-81404HV	26
H-43720	39	H-50612W	22	H-51703WT	37	H-71273W	6, 30	H-75704	18	H-81404W	26
H-43721	39	H-50613	22	H-51704	37	H-72003-V	20	H-75713	18	H-81404WHV	26
H-43722	39	H-50613W	22	H-51704SSL	37	H-72004-V	20	H-75714	18	H-81405	26
H-43722-OH	39	H-50614	22	H-51704SSW	37	H-72162W	6	H-76202W	6	H-81405HV	26
H-43723	39	H-50614W	22	H-51704T	37	H-72163W	6	H-76202W-CAN	6	H-81405W	26
H-43723-OH	39	H-50615	22	H-51704W	37	H-72164W	6	H-76203W	6	H-81405WHV	26
H-43724	39	H-50615W	22	H-51704WSSL	37	H-72202W	6	H-76203W-CAN	6	H-81406	26
H-43724-OH	39	H-50616	22	H-51704WSSW	37	H-72202W-CAN	6	H-77201W	8	H-81406HV	26
H-43725	39	H-50616W	22	H-51704WT	37	H-72203W	6	H-77201W-TG	8	H-81406HV-RF375	28
H-43726	39	H-50617	22	H-51705	37	H-72203W-CAN	6	H-77211W	8	H-81406W	26
H-43727	39	H-50617W	22	H-51705SSL	37	H-72204W	6	H-77211W-TG	8	H-81406WHV	26
H-43900	39	H-50622W	38	H-51705W	37	H-72204W-CAN	6	H-77401W	8	H-81407HV	26
H-43901	39	H-50623W	38	H-51705WSSL	37	H-72272W	6	H-77401W-TG	8	H-81407HV-RF400	28

INDEX

PART NUMBER	PAGE	PART NUMBER	PAGE	PART NUMBER	PAGE
H-81407HV-RF475	28	H-84444WPR-LF	11	H-101413WHV	33
H-81407WHV	26	H-84613	22	H-101414WHV	33
H-81413	26	H-84614	22	H-101415WHV	33
H-81413HV	26	H-85443WPR	11	H-101416WHV	33
H-81413W	26	H-85443WPR-LH	11	H-101417WHV	33
H-81413WHV	26	H-88354-43	15, 17	H-101702W	33
H-81414	26	H-88354-44	15, 17	H-101703W	33
H-81414HV	26	H-88613	25	H-101704W	33
H-81414W	26	H-88614	25	H-101705W	33
H-81414WHV	26	H-88615	25	H-101706W	33
H-81415	26	H-88616	25	H-101707W	33
H-81415HV	26	H-88643	24	H-104702W	33
H-81415W	26	H-88644	24	H-104703W	33
H-81415WHV	26	H-88654	24	H-104704W	33
H-81416	26	H-88655	24	H-104705W	33
H-81416HV	26	H-88754-43	15, 17	H-104706W	33
H-81416WHV-RF375	28	H-88754-44	15, 17	H-104707W	33
H-81416W	26	H-88765-45	15, 17	H-C7-303	7
H-81416WHV	26	H-88854-43	15, 17	H-FSTR4-54	17
H-81417HV	26	H-88854-44	15, 17	H-FSTR5-55	17
H-81417HV-RF400	28	H-88865-45	15, 17	H-G0673W	9
H-81417HV-RF475	28	H-90613W	32	H-G1404W	7, 19
H-81417WHV	26	H-90614W	32	H-G1404W-A-KITB	7
H-81424HV	28	H-90615W	32	H-G1404WHV	7, 19
H-81612W	22, 31	H-90616W	32	H-G1404W-KITB	7
H-81613W	22, 31	H-90617W	32	H-G1414W	7, 19
H-81614W	22, 31	H-91403WHV	32	H-G1414W-A-KITB	7
H-81615W	22, 31	H-91404WHV	32	H-G1414WHV	7, 19
H-81616W	22, 31	H-91405WHV	32	H-G1414W-KITB	7
H-81617W	22, 31	H-91406WHV	32	H-HCE4-43	17
H-81702	37	H-91407WHV	32	H-HCE4-44	17
H-81702W	37	H-91413WHV	32	H-HCE4-53	17
H-81703	37	H-91414WHV	32	H-HCE4-54	17
H-81703W	37	H-91415WHV	32	H-HCE4-63	17
H-81704	37	H-91416WHV	32	H-HCE4-64	17
H-81704W	37	H-91417WHV	32	H-HCE4-73	17
H-81705	37	H-91702W	32	H-HCE4-74	17
H-81705W	37	H-91703W	32	H-HCE4-94	17
H-81706	37	H-91704W	32	H-HCE5-44	17
H-81706W	37	H-91705W	32	H-HCE5-45	17
H-81707	37	H-91706W	32	H-HCE5-54	17
H-81707W	37	H-91707W	32	H-HCE5-55	17
H-81708W	37	H-94702W	32	H-HCE5-64	17
H-81709W	37	H-94703W	32	H-HCE5-65	17
H-81710W	37	H-94704W	32	H-HCE5-74	17
H-83612W	22, 31	H-94705W	32	H-HCE5-75	17
H-83613W	22, 31	H-94706W	32	H-RF4-54	17
H-83614W	22, 31	H-94707W	32	H-RF5-55	17
H-83615W	22, 31	H-100613W	33	H-SE-91413	32, 33
H-83616W	22, 31	H-100614W	33	H-SE-91414	32, 33
H-83617W	22, 31	H-100615W	33	H-SE-91415	32, 33
H-84063W	11	H-100616W	33	H-SE-91416	32, 33
H-84443W	11	H-100617W	33	H-SE-91702	32, 33
H-84443WPR	11	H-101403WHV	33	H-SE-91704	32, 33
H-84443WPR-LF	11	H-101404WHV	33	H-SE-91705	32, 33
H-84444W	11, 17	H-101405WHV	33	H-SE-91706	32, 33
H-84444WPR	11	H-101406WHV	33	H-SE-91707	32, 33
H-84444WPR3	17	H-101407WHV	33		

TERMS OF SERVICE

TERMS OF PAYMENT

2% 10th of the following month. Cash discount is calculated on the total amount of the invoice before additions for freight. A 1 1/2% per month service charge will be added to any past due balances.

FREIGHT ALLOWANCE

Contact Customer Service at 800-225-9529 or webstone@nibco.com.

MINIMUM ORDER

No minimum order when placed via NIBCO Partner or EDI Transmission. Orders submitted through other mediums are subject to a \$50 minimum.

CLAIMS OF SHORTAGE OR VARIANCE

Claims of any character must be made within 10 days after receipt of goods. Settlements of any claims are at the discretion of Webstone, a brand of NIBCO.

RETURNS

Webstone, a brand of NIBCO, reserves the right to charge a 30% restocking fee on any returned merchandise. Overstock returns for products that have been discontinued, redesigned, or purchased prior to the previous 12 months will not be accepted. Product returns will not be granted in November or December of any year unless such return is being made as a warranty return or in the event that an incorrect product was shipped. Purchase order or invoice numbers are required for all returns.

An issued Return Goods Authorization form is required for all product returns. No product returns less than \$100 will be accepted.

ORDER CONFIRMATIONS

All orders are subject to acceptance by Webstone, a brand of NIBCO. Prices are subject to change without notice.

STANDARD PACKAGING

Typically, shipments are made in case and carton quantities. However, Webstone, a brand of NIBCO, will ship any quantities ordered.

UPC BARCODING

100% of products will be shipped with barcodes if customer specifies the need.

Third Party Approvals and Standards Organizations



CSA Group
www.csagroup.org

IAPMO R&T
www.iapmort.org



Unless otherwise designated, lead-free certification (NSF/ANSI 61 & NSF/ANSI 372) was performed by Truesdail Laboratories.
www.truesdail.com



Certified to the Uniform Plumbing Code

Note:

Third Party Approval Agencies often can approve products to a wide variety of standards; some of the standards may be under the responsibility of another agency. For example, IAPMO can issue approvals to NSF/ANSI 61 standard, as can Truesdail, CSA, etc.

Product identified as being constructed of Lead-Free Brass have a maximum weighted average lead content of 0.25% of the wetted surface of the product in accordance with the requirements of the Reduction of Lead in Drinking Water Act.

Product identified as being constructed of standard brass have a lead content in excess of the 0.25% limit and are not to be used in potable water systems.

Pressure Relief Valve capacity ratings listed are the ASME National Board value.

Definition of Terms

CWP: Cold Working Pressure: This designates the maximum non-shock operating pressure of the product. The "Cold" is defined as temperatures in the range from above freezing to 100°F. Above 100°F the maximum allowable pressure decreases as listed in the product specification sheet.

WSP: Working Steam Pressure: Indicates the maximum steam pressure of the product. This rating is independent from the CWP rating. The WSP rating is lower than the CWP rating.

Webstone[®]
a brand of **NIBCO**[®]

VALVE INNOVATION
GUARANTEED FOR LIFE

CONDITIONS APPLY. SEE WEBSTONEVALVES.COM FOR FULL DETAILS.

800-225-9529

www.webstonevalves.com

