

Price List

AquaLock™ Push-to-Connect Plumbing Fittings



Effective March 6, 2023

All prices supersede previous issues, are temporary and subject to change without notice.

AquaLock™

Watts.com

WATTS®

LEAD FREE*

Before using standard material product for potable water systems consult your local water authority and building & plumbing codes. Interpretation of the new federal Lead Free law, effective January 4, 2014, may vary according to local governing authorities.

*The wetted surface of this product contacted by consumable water contains less than 0.25% of lead by weight.

Electronic is Green!

For the latest Watts pricing information in electronic format, visit our Data Exchange at:

<https://www.watts.com/resources/electronic-data-services>

- Download product and list price data in .csv, .pdf, .tsv, .xls and .xml formats
- Easy access to list price data for business systems
- Sign up for e-mail alerts when data is updated
- Access other Watts Water Technologies brands pricing data

Table of Contents

- Terms & Conditions** 2
- Technical Information**.....3-5
- Features**6-7
- Model Number Meaning**..... 8

Brass Series

- Tees**
- Tee w/Gauge 9
- Reducing Tees 9
- Double Reducing Tees 9
- Repair Tees..... 9

Elbows

- Elbows..... 10
- Reducing Elbows 10
- Stackable Elbows 10
- Male Elbows 10
- Female Elbows 10
- Drop Ear Elbows 10
- Elbow 45° 10

Connectors

- Couplings 11
- Reducing Couplings 11
- Male Adapters 11
- Female Adapters 11
- Slip Repair Couplings 11

Stems

- Male Stems 12
- Female Stems 12

Ends

- End Caps 12

Valves

- Ball Valves 12
- Tee Valves 12
- Washing Machine Valves 12
- Garden Hose Valves 12

Plastic Series

Tees

- Reducing Tees 13
- Double Reducing Tees 13
- Male Threaded Tees 13
- Stackable Tees 14
- Reducing Stackable Tees 14
- Stackable Branch Tees 14

Elbows

- Elbows..... 15
- Reducing Elbows 15
- Stackable Elbows 15
- Male Elbows 15
- Female Swivel Elbows 16
- Drop Ear Elbows 16
- Hose Barb Elbows..... 16
- Elbow Pump Connector..... 16

Connectors

- Couplings 17
- Reducing Couplings 17
- Male Adapters 17
- Female Swivel Adapters..... 18
- Hose Barb Adapters 18
- Pump Adapters 18

Stems

- Male Stems 19
- Female Stems..... 19
- Reducing Stems 19
- Hose Barb Stems..... 19

Ends

- End Caps 19

Valves

- Straight Valves 20
- Female Straight Valves..... 20
- Stackable Valves 20
- Tee Valves 20
- Check Valves 20
- 3-Way Selector Valves 21
- 3-Way Bypass Valves 21
- Angle Valves 21
- Female Angle Valves 21
- Female Angle Valves GHT 21
- Panel Mount Valve 21
- Shutoff Valves..... 21
- Garden Hose Angle Valve 21

Miscellaneous

- Collet Clips 22
- Collet Covers 22
- Cone Seal 22
- Pipe Inserts 22

Manifolds - Single

- Manifolds - Single Body..... 23
- Manifolds - Single Stem Body - Right..... 23
- Manifold - Single Stem Body - Left..... 23
- Manifold Single Side Mounting Kits..... 23

Manifolds - Dual

- Manifolds - Dual Body 23
- Manifolds - Dual Stem Body 23
- Manifold Dual Side Mounting Kits 23

Manifold Accessories

- Manifold Return Ends 24
- Manifold Return Ends 24
- Manifold Red Label Plates 24
- Manifold Blue Label Plates 24
- Manifold Valve Repair Kits 24
- MT Manifold Tool 24
- End Plugs 24

Mini Series

Tees

- Tees..... 25
- Reducing Tees 25

Elbows

- Elbows..... 26
- Reducing Elbows 26
- Stackable Elbows 26
- Male Elbows 26

Connectors

- Couplings 27
- Reducing Couplings 27
- Male Adapters 27
- Female Adapters..... 28

Stems

- Male Stems 28
- Reducing Stems 28

Stops

- End Caps 28

Valves

- Straight Valves 29
- Male Straight Valves 29
- Female Angle Valves 29

Metric Series

Tees

- Reducing Tees 30
- Stackable Tees 30

Elbows

- Elbows..... 31
- Stackable Elbows 31
- Male Elbows 31
- Female Swivel Elbows 31
- Drop Ear Elbows 31
- Elbow Pump Adapters..... 31

Connectors

- Couplings 32
- Reducing Couplings 32
- Male Adapters 32
- Female Swivel Adapters..... 32
- Hose Barb Adapters 33
- Pump Adapters 33
- Compression Adapters (Brass) 33

Stems

- Male Stems (Brass)..... 33
- Reducing Stem 33

Ends

- End Caps 33
- End Plugs 33

Valves

- Straight Valves 34
- Stackable Valves 34
- Tee Valves 34
- Check Valves 34
- Male Stem Check Valves (Brass)..... 34
- Stem Check Valves (Brass) 34

Miscellaneous

- Collet Clip 35
- Collet Cover 35
- Elbow Clip 35

Terms and Conditions

- FREIGHT TERMS:** All shipments are F.O.B. shipping point. Shipments from factory less than 1000 lbs. are F.O.B. factory. Factory shipments of 2500 and over within the continental U.S.A. will be prepaid and allowed when made at the lowest motor carrier transportation rate.
- TERMS OF SALE:** All sales are F.O.B. shipping point.
- PAYMENT TERMS:** The invoices are due and payable 30 days from the date of invoice.
- PURCHASE ORDER FORMS:** Orders submitted on customer's own purchase order forms will be accepted only with the express understanding that no statements, clauses, or conditions contained in said order form will be binding on the Seller if they in any way modify the Seller's own terms and conditions of sales.
- SPECIAL PRODUCTS:** Orders for special or modified products are non-cancelable. In the event that the customer cancels an order for such products, Watts shall charge the customer an amount equal to Watts' costs and expenses incurred in performing the purchase order prior to receipt of notice of cancellation.

LIMITED WARRANTY: A. Watts Regulator Co. ("Watts") warrants its WaterPEX® cross-linked polyethylene tubing, barbed PEX fittings, brass and plastic AquaLock™ fittings and manifolds, factory manufactured copper manifolds and AquaLock™ accessories to be free of defects in material and workmanship when used under normal usage in potable water systems, and installed in accordance with all Watts printed installation instructions. Specific warranty durations apply as follows:



1. Watts WaterPEX® cross-linked polyethylene (non-barrier PEX) pipe, brass and plastic barbed PEX fittings, and factory manufactured copper manifolds when installed as a system using Watts WaterPEX pipe, Watts brass or plastic barbed PEX fittings, and Watts factory manufactured copper manifolds for a period of twenty-five (25) years from the date of original shipment.
2. Watts WaterPEX® cross-linked polyethylene (non-barrier PEX) pipe, when installed with brass or plastic barbed PEX fittings manufactured by others that meet the applicable ASTM Standards (brass - ASTM F 1807) (plastic - ASTM F 2159) for a period of ten (10) years from the date of original shipment.
3. Watts WaterPEX® brass or plastic barbed PEX fittings and factory manufactured copper manifolds when installed with cross-linked polyethylene (non-barrier PEX) pipe manufactured by others that meet the ASTM F 876 requirements for a period of ten (10) years from the date of original shipment.
4. Brass, Plastic and Mini AquaLock™ fittings and manifolds for a period of twenty-five (25) years from the date of original shipment.
5. All other valves and accessories sold under the Watts WaterPEX or Watts AquaLock™ brand name for a period of two (2) years from the date of original shipment.

Watts's obligation will be to repair or replace, at its discretion, any of these products proven to be defective in material or workmanship when these products are covered under this limited warranty.

- B. In the event of a system malfunction or leak caused by defective Watts warranted materials (and not by incorrect installation, incorrect handling procedures or by jobsite or installation damage), a reasonable pre-approved amount will be allowed for repair materials and repair labor. In the event of a leak occurring in a factory manifold, you may contact Watts for either a free replacement manifold or any parts reasonably needed to repair such a leak (freight prepaid). Note that Watts limits its warranty to its tubing, valves and accessories, fittings and manifolds. Watts does not warrant the connection on any installation, as the integrity of the connection is subject to the workmanship of the contractor/installer. The connection is the sole responsibility of the person who installs it.
- C. In order to qualify for a warranty remedy under paragraph B, you must contact Watts in advance and receive a written authorization for this remedy from an authorized Watts representative. Repair materials, repair labor and freight expenses not authorized in writing in advance by Watts in this way will not be compensated.
- D. To qualify for the warranty described above, you must do the following:
1. Use good construction techniques to install our materials, as specified in our current design and installation guidelines and technical notes. This must include field pressure testing our warranted materials before they are covered by concrete or otherwise made inaccessible.
 2. Install Watts WaterPEX® and Watts AquaLock™ materials according to all guidelines and manuals published by Watts.
 3. Install Watts WaterPEX® and Watts AquaLock™ products in a system that will not operate at temperatures or at pressures that exceed the rating printed on the tubing.
 4. The Watts warranted product must be installed in compliance with local building and plumbing codes.
- E. Evidence of tampering, mishandling, neglect, accidental damage, freeze damage or unauthorized repairs that cause damage to Watts's warranted products will void any warranty coverage for those particular products. All field connections are specifically excluded from the terms of this warranty.
- F. Watts provides a complete plumbing system offering so that it is possible to complete an installation with Watts products. However, it is possible that other manufacturers' tubing and/or fittings may be installed in any given installation. Providing that the tubing and/or fittings are manufactured to their applicable ASTM standards, and have been certified by a recognized third-party testing agency, the Watts product in the given installation will continue to be covered under this warranty. In the event of a system malfunction or leak that has other tubing and/or fitting manufacturers' components installed within the failed system, Watts will be responsible only for proven defects in material or workmanship in the Watts products. Products manufactured by another company should be reported to that manufacturer for its warranty response.
- G. Disclaimer of Warranty. **THE WARRANTY SET FORTH HEREIN IS GIVEN EXPRESSLY AND IS THE ONLY WARRANTY GIVEN BY WATTS WITH RESPECT TO THE PRODUCTS LISTED IN PARAGRAPH A. WATTS MAKES NO OTHER WARRANTIES, EXPRESS OR IMPLIED. WATTS HEREBY SPECIFICALLY DISCLAIMS ALL OTHER WARRANTIES, EXPRESS OR IMPLIED, INCLUDING BUT NOT LIMITED TO THE IMPLIED WARRANTIES OF MERCHANTABILITY AND FITNESS FOR A PARTICULAR PURPOSE.**
- H. Limitation of Liability. The remedy described above shall constitute the sole and exclusive remedy for breach of warranty, and, apart from that remedy, Watts shall not be responsible for any incidental, special or consequential damages, including without limitation, lost profits or the cost of repairing or replacing other property which is damaged if these warranted products do not work properly, other costs resulting from labor charges, delays, vandalism, negligence, fouling caused by foreign material, damage from adverse water conditions, adverse chemical environments, or any other circumstances over which Watts has no control. This warranty shall be invalidated by any abuse, misuse, misapplication or improper installation of the product. Some states do not allow limitations on how long an implied warranty lasts, and some states do not allow the exclusion or limitation of incidental or consequential damages. Therefore the above limitations may not apply to you. This Limited Warranty gives you specific legal rights, and you may have other rights that vary from state to state. You should consult applicable state laws to determine your rights. **SO FAR AS IS CONSISTENT WITH APPLICABLE STATE LAW, ANY IMPLIED WARRANTIES THAT MAY NOT BE DISCLAIMED, INCLUDING THE IMPLIED WARRANTIES OF MERCHANTABILITY AND FITNESS FOR A PARTICULAR PURPOSE, ARE LIMITED IN DURATION TO ONE YEAR FROM THE DATE OF ORIGINAL SHIPMENT.**
- I. RETURNED GOODS: No material shall be returned without authorization. When credit is issued it will be at the price charged, or prevailing price if lower, less handling charges based on costs of reconditioning, boxing, etc. However, a minimum 25% handling charge will apply. A minimum handling charge of 20.00 is applied whenever the 25% handling deduction does not total 20.00. Products which are obsolete or made to special order are not returnable.

NOTE: Prices and terms are subject to change without notice and supersede all previous quotations. The right is reserved to change or modify product design or construction without prior notice and without incurring an obligation to make such changes and modifications on products previously or subsequently sold.

Technical Information - Brass Fittings

Material Specifications

Body:	Lead Free* Brass Alloy
O-Ring:	EPDM
Gripper Ring:	Stainless Steel
Push Ring:	Delrin
Tube Liner:	Polysulfone
Push Ring Clip:	Delrin

Fitting Performance

AquaLock™	Max. Pres.	200psi @ 200°F	(13.8 bar @ 93°C)
Brass	Min. Temp.	33°F (0.5°C)	

Approvals



ASTM F877: Watts Brass AquaLock™ fittings are tested, certified and approved to ASTM F877 performance standards.



IAPMO ASSE 1061: Watts Brass AquaLock™ fittings are tested, certified and approved to ASSE 1061, and approved to Canadian Standard CSA B137.5 and NSF/ANSI 61.

Lead free product is certified to NSF/ANSI 372 and conforms with the lead content requirements for lead free plumbing as defined by California, Vermont, Maryland, and Louisiana state laws and the U.S. Safe Drinking Water Act.

*The wetted surface of this product contacted by consumable water contains less than 0.25% of lead by weight.

Watts AquaLock™ Brass fittings are designed and manufactured to be trouble free for many years of service. All Brass fittings are tested, approved and certified to NSF/ANSI 61, CSA B137.5, ASTM F877 and ASSE 1061. Brass fittings are available in standard imperial inch sizes. The unique design of Brass fittings allows for quick and easy connections without installation tools.

Watts AquaLock™ Brass fittings are designed for potable water systems. For other applications please refer to our Technical Service Department. Tubing should be supported at minimum of 36" to prevent excessive load to the connectors. Do not install tubing supports closer than 3 inches from the connector ends. We strongly recommend that new installations be thoroughly tested prior to use. Do not use with explosive gases, petroleum products, or other fuels.

⚠ CAUTION

The polysulfone material used in the AquaLock™ fittings can be compromised by exposure to volatile organic compounds (VOC's) and caustic chemicals. Therefore, **DO NOT** expose this product to any such chemical or foreign substance, which would include exposure to the following products:

Pipe Dopes (thread sealants), bug sprays, lubricants, cleaners, paints, bleaches, acids, solder fluxes, plastic piping primers and cements, oxidizing agents, alkaline solutions, thinners, fuels, oil based caulks, hydrocarbons, spray foam or foaming agents (insulation).

Watts recommends that all fittings and parts be stored in their original packaging until installation to protect the fitting internals from dirt and debris that may cause damage to the o-ring and the o-ring guide.

It is also recommended that all threaded connections be made with Teflon® tape only.

Failure to follow these instructions will void the warranty and possibly result in leaks and water damage.

All Brass Fittings come complete with a removable push ring clip to prevent accidental release of the fitting prior to pressurization.



Technical Information - Plastic Fittings

Material Specifications

Body:	Polysulfone
Collet:	Nylon
O-Ring:	EPDM
Spacer:	Acetal
Tube Liner:	Polysulfone
Collet Clip:	Delrin

Fitting Performance

AquaLock™	Max. Pres.	250psi @ 75°F	(17.25 bar @ 24°C)
Plastic	Max. Temp.	100psi @ 180°F	(6.8 bar @ 82°C)
	Min. Temp.	33°F (0.5°C)	

Thread Torque Values

Size	Min. Torque Values	Max. Torque Values
1/2"	17.7 in - lbs.	26.5 in - lbs.
3/4"	22.7 in - lbs.	31 in - lbs.

Approvals

FDA: Watts Plastic fittings are produced from FDA approved materials.

NSF/ANSI 61-G: Watts Plastic fitting products are tested, certified, and approved for contact with drinking water.

NSF/ANSI 14: Watts Plastic fitting products are tested, certified, and approved to NSF-14 standards.

ASTM F877: Watts Plastic fitting products are tested, certified, and approved to ASTM F877 performance standards.

NSF-U.P. Code: Watts Plastic fitting products are tested, certified, and approved and meet the requirements of the Uniform Plumbing Code.

IAPMO ASSE 1061: Watts Plastic fitting fittings are tested, certified and approved to ASSE 1061 for AquaLock™ fittings and approved to Canadian Standard CSA B137.5.

Lead free product is certified to NSF/ANSI 372 and conforms with the lead content requirements for lead free plumbing as defined by California, Vermont, Maryland, and Louisiana state laws and the U.S. Safe Drinking Water Act.

*The wetted surface of this product contacted by consumable water contains less than 0.25% of lead by weight.

Watts AquaLock™ Plastic fittings are designed and manufactured to be trouble free for many years of service life. Plastic fitting products are designed and manufactured in polysulfone, a high performance thermal plastic material. All Plastic fitting products are approved and certified to NSF-61-G, NSF 14, CSA B137.5, ASTM F877, and to the Uniform Plumbing Code (U.P. Code) and ASSE 1061. Plastic fitting products are available in standard imperial inch sizes. The Watts AquaLock™ design allows for quick and easy connections without installation tools. Simply cut the plastic, copper or CPVC tubing and snap a Watts AquaLock™ fitting in place for a zero-leak connection.

Watts AquaLock™ Plastic fittings are designed for potable water systems. For other applications please refer to our Technical Service Department. Tubing should be supported at minimum of 36" to prevent excessive load to the connectors. Do not install tubing supports closer than 3 inches from the connector ends. We strongly recommend that new installations be thoroughly tested prior to use. Do not use with explosive gases, petroleum products, or other fuels.

⚠ CAUTION

The polysulfone material used in the AquaLock™ fittings can be compromised by exposure to volatile organic compounds (VOC's) and caustic chemicals. Therefore, **DO NOT** expose this product to any such chemical or foreign substance, which would include exposure to the following products: **Pipe Dopes (thread sealants)**, bug sprays, lubricants, cleaners, paints, bleaches, acids, solder fluxes, plastic piping primers and cements, oxidizing agents, alkaline solutions, thinners, fuels, oil based caulks, hydrocarbons, spray foam of foaming agents (insulation).

Watts recommends that all fittings and parts be stored in their original packaging until installation to protect the fitting internals from dirt and debris that may cause damage to the o-ring and the o-ring guide.

It is also recommended that all threaded connections be made with Teflon® tape only.

Failure to follow these instructions will void the warranty and possibly result in leaks and water damage.



Technical Information - Mini Fittings

Material Specifications

Body:	Polypropylene
Collet:	Acetal
O-Ring:	EPDM
Spacer:	Acetal

Fitting Performance

AquaLock™	Max. Pres.	150psi @ 70°F	(10.3 bar @ 20°C)
Mini	Max. Temp.	60psi @ 140°F	(4.1 bar @ 60°C)
	Min. Temp.	33°F (0.5°C)	

Thread Torque Values

Size	Max. Torque Values
1/8", 1/4" (3.8mm)	13.3 in - lbs. (1.5 Nm)
3/8", 1/2" (10, 15mm)	26.6 in - lbs. (3.0 Nm)

Approvals



FDA: Watts AquaLock™ Mini fittings are produced from FDA approved materials.



NSF/ANSI 61-G: Watts AquaLock™ Mini fitting products are tested, certified, and approved for contact with drinking water.

Lead free product is certified to NSF/ANSI 372 and conforms with the lead content requirements for lead free plumbing as defined by California, Vermont, Maryland, and Louisiana state laws and the U.S. Safe Drinking Water Act.

*The wetted surface of this product contacted by consumable water contains less than 0.25% of lead by weight.

Watts AquaLock™ Mini fittings are designed and manufactured to be trouble free for many years of service life. Mini fitting products are designed and manufactured in polypropylene, a rugged thermoplastic polymer. All Mini fitting products are approved and certified to NSF-61-G. Mini fitting products are available in standard imperial inch sizes. The Watts AquaLock™ design allows for quick and easy connections without installation tools. Simply cut the plastic or copper piping and snap a Watts AquaLock™ fitting in place for a zero leak connection.

Watts AquaLock™ Mini fittings are designed for low pressure fluids. For other applications please refer to our Technical Service Department. Tubing should be supported at minimum of 36" to prevent excessive load to the connectors. Do not install tubing supports closer than 3 inches from the connector ends. We strongly recommend that new installations be thoroughly tested prior to use. Do not use with explosive gases, petroleum products, or other fuels.

⚠ CAUTION

The polypropylene material used in the AquaLock™ fittings can be compromised by exposure to volatile organic compounds (VOC's) and caustic chemicals. Therefore, **DO NOT** expose this product to any such chemical or foreign substance, which would include exposure to the following products: **Pipe Dopes (thread sealants)**, bug sprays, lubricants, cleaners, paints, bleaches, acids, solder fluxes, plastic piping primers and cements, oxidizing agents, alkaline solutions, thinners, fuels, oil based caulks, hydrocarbons, spray foam or foaming agents (insulation).

Watts recommends that all fittings and parts be stored in their original packaging until installation to protect the fitting internals from dirt and debris that may cause damage to the o-ring and the o-ring guide.

It is also recommended that all threaded connections be made with Teflon® tape only.

Failure to follow these instructions will void the warranty and possibly result in leaks and water damage.



Features

Making a Fast and Secure Connection with Mini and Plastic Fittings

1 Cut the pipe or tubing squarely using a sharp tubing cutter (plastic) or rotary copper pipe cutter (copper). Inspect the outside diameter of the pipe or tubing to be sure there is no damage, nicks, burrs, or debris. Deburr and clean pipe or tubing as necessary.

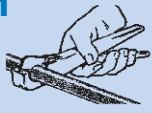

2 Measure the insertion depth on the pipe or tubing end. The fittings have an insertion line molded into the body of the fitting.

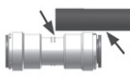

3 For PEX Pipe used with Plastic, gently insert a tube liner (provided for each connection with fitting) into the pipe end.**



4 Make certain to push the tubing completely into the fitting until it comes into contact with the internal tube stop.

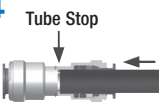

5 To disconnect, ensure system has been depressurized before removing fitting. Push the collet in squarely against the face of the fitting. With the collet held securely in this position, the tubing can be removed.



Zero-Leak O-Ring Guide

All Watts AquaLock™ Plastic fittings incorporate an exclusive patented O-ring Guide for improved reliability. This unique feature provides a zero-leak connections by:

- Protecting the O-ring from damage during connection
- Increasing the connectors' side load capacity
- Correctly aligning the tubing with the O-ring every time.
- Preventing the O-ring from becoming dislodged.

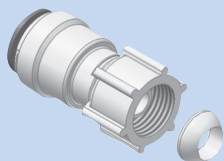
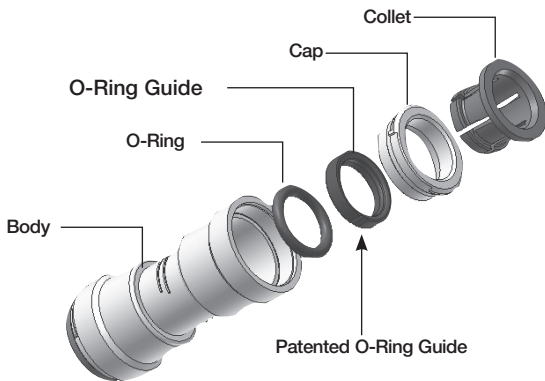

Watts AquaLock™ fittings utilize a swivel nut with NPS straight threads and a cone seal. This allows the installer to thread onto NPT, NPS, BSP, and most threads without tools or thread sealant. Simply thread on, hand tight, for a zero leak seal.

Connect to Multiple Materials

The Watts AquaLock™ fittings incorporate Stainless Steel Gripping Teeth in its Collet. These corrosion resistant teeth allow AquaLock™ fittings to interconnect with multiple materials without tools.

- LDPE, MDPE, & HDPE PEX Tubings
- Copper
- CPVC
- Non-Oxygen Barrier PEX
- Potable Monowall PEX

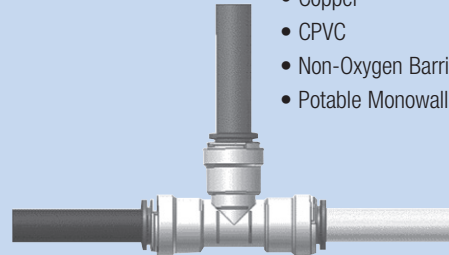

Rotates under pressure

After a joint is made the tubing can still swivel while connected, even under maximum pressure. The ability to rotate under pressure makes these connectors ideal for vibrating and dynamic applications.



Highest Flow

Watts AquaLock™ fittings join the tubing on the outside. Because there is no barb fitting on the inside of the tubing the flow capacity is increased by more than 30%. Only AquaLock™ fittings offer complete flow, allowing for a more efficient system.

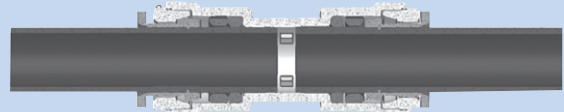

Create mini-manifolds

With AquaLock™ fittings small lengths of tubing can be eliminated by using our stackable connector configurations. Simply snap together Tees and/or Elbows to create a mini-manifold of fittings. Because AquaLock™ fittings rotate the direction of the tubing can be oriented by a simple twist, reducing the amount of tubing required to plumb a water system.



**To comply with ASSE 1061, a tube liner (provided) must be used on all PEX pipe connections Plastic AquaLock™.

Making a Fast and Secure Connection with Brass Fittings

1

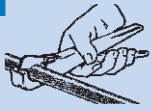

Cut the pipe or tubing squarely using a sharp tubing cutter (plastic) or rotary copper pipe cutter (copper). Inspect the outside diameter of the pipe or tubing to be sure there is no damage, nicks, burrs, or debris. Deburr and clean pipe or tubing as necessary.

2

Measure the insertion depth on the pipe or tubing end. For Brass fittings, use the Insertion Depth Guide provided.

Insertion Depth Guide		
Size	Insertion Depth	
3/8" CTS	1"	25mm
1/2" CTS	1"	25mm
3/4" CTS	1 1/8"	29mm
1" CTS	1 1/4"	32mm

3

For PEX Pipe, gently insert a tube liner (provided for each connection with fitting) into the pipe end.**



4

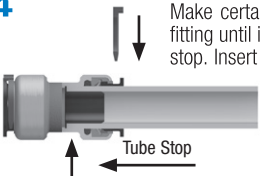

Make certain to push the tubing completely into the fitting until it comes into contact with the internal tube stop. Insert push ring clip.

5

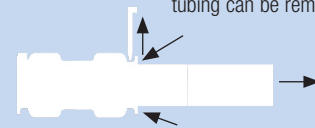

To disconnect, ensure system has been depressurized before removing fitting. Remove push ring clip. **Push ring does not require a disconnect tool.** Push the push ring in squarely against the face of the fitting. With the push ring held securely in this position, the tubing can be removed.

Slip Repair Fittings (For copper and CPVC only)

1. Remove 2" section of pipe. Ensure pipe is cut squarely and is free of damage, nicks, burrs, or debris.
2. Measure the insertion depth of the pipe using the depth gauge mark on one end of the fitting.
3. Push pipe and Slip End of fitting together.
4. Press the push ring of Slip End and slide the fitting onto the end of the pipe with insertion depth until it reaches the internal tube stop.

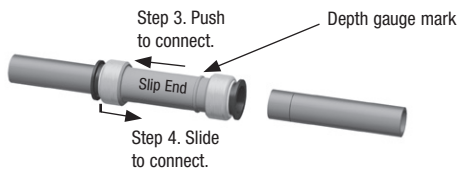

5. Insert push ring clips.



Connect to Multiple Materials

The Watts AquaLock™ fittings incorporates a Stainless Steel Gripper Ring. These corrosion resistant teeth allow AquaLock™ fittings to interconnect with multiple materials without tools.

- LDPE, MDPE, & HDPE PEX Tubings
- Copper
- CPVC
- Non-Oxygen Barrier PEX
- Potable Manowall PEX

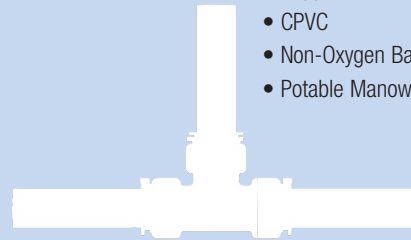

Rotates under pressure

After a joint is made the tubing can still swivel while connected, even under maximum pressure. The ability to rotate under pressure makes these connectors ideal for vibrating and dynamic applications.

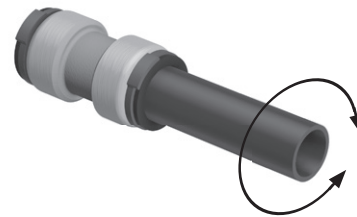

Highest Flow

Watts AquaLock™ fittings join the tubing on the outside. Because there is no barb fitting on the inside of the tubing the flow capacity is increased by more than 30%. *Only AquaLock™ fittings offer complete flow, allowing for a more efficient system.



*For Non-PEX pipe, AquaLock fittings do not require a pipe insert. This allows AquaLock fitting to ensure that flow is unrestricted unlike other connections that have the tube liner built into the fitting.

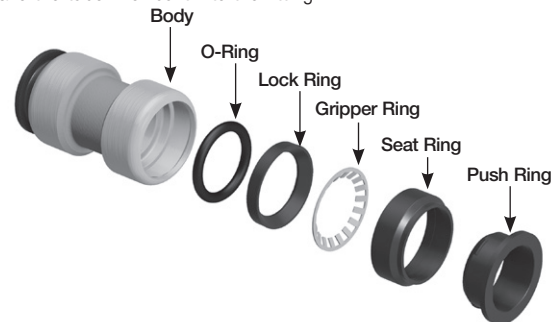

**To comply with ASSE 1061, a tube liner (provided) must be used on all PEX pipe connections (Brass AquaLock™ Series).

Model Number Meaning

Example: 35 10 – 10 R 14 CP

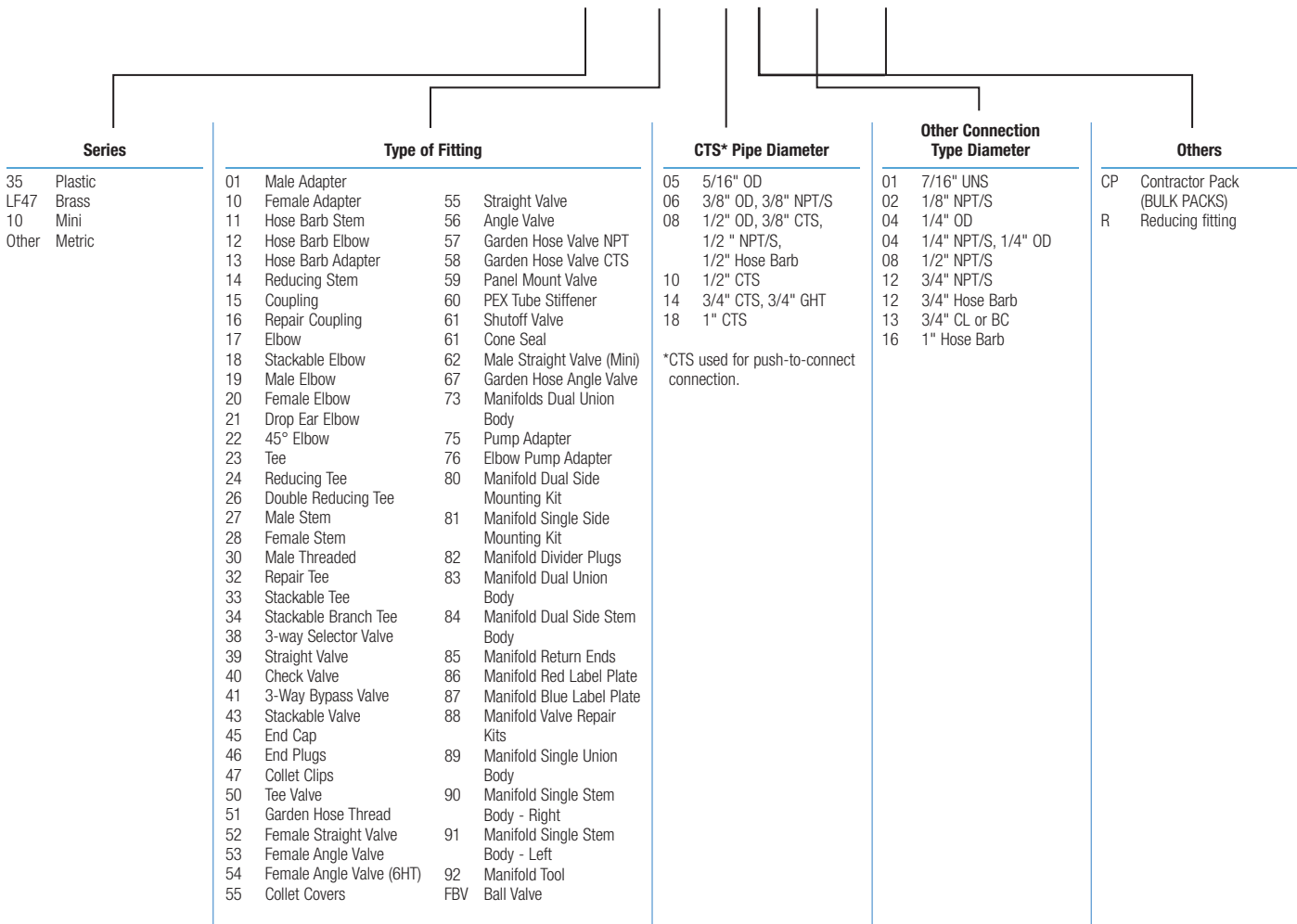

*The wetted surface of this product contacted by consumable water contains less than 0.25% of lead by weight.

Consult factory for ordering code numbers of special models/options.

Model	Ordering Code	Size & Connection	UPC	Unit Pack Qty.	(Inner Ctn.) Minimum Order Qty.	Master Carton Qty.	Unit Weight (lbs.)	List Price Unit Pack
-------	---------------	-------------------	-----	----------------	---------------------------------	--------------------	--------------------	----------------------

Brass Tees

Tees

Package Type: Single Pack



LF4723

LEAD FREE	LF4723-10	0472035	1/2" x 1/2" x 1/2" CTS	098268022315	1	12	120	0.23	\$ 25.50
	LF4723-14	0472036	3/4" x 3/4" x 3/4" CTS	098268022322	1	12	120	0.4	30.75
	LF4723-18	0472037	1" x 1" x 1" CTS	098268022339	1	6	60	0.66	92.75

Tee w/Gauge

Package Type: Single Pack

LEAD FREE	LF4723G-14	0472070	3/4" x 3/4" CTS	098268145922	1	5	50	0.7	104.50
-----------	------------	---------	-----------------	--------------	---	---	----	-----	--------

Reducing Tees

Package Type: Single Pack



LF4724R

LEAD FREE	LF4724R-141410	0472038	3/4" x 3/4" x 1/2" CTS	098268022346	1	12	120	0.34	28.25
	LF4724R-141014	0472040	3/4" x 1/2" x 3/4" CTS	098268022360	1	12	120	0.36	29.25

Double Reducing Tees

Package Type: Single Pack



LF4726R

LEAD FREE	LF4726R-141010	0472042	3/4" x 1/2" x 1/2" CTS	098268022391	1	6	60	0.35	26.50
-----------	----------------	---------	------------------------	--------------	---	---	----	------	-------

Repair Tees

Package Type: Single Pack



LF4732

LEAD FREE	LF4732-10	0472050	1/2" CTS	098268022568	1	6	60	0.32	33.25
	LF4732-14	0472051	3/4" CTS	098268022582	1	6	60	0.4	40.25
	LF4732-18	0472052	1" CTS	098268022612	1	6	60	0.44	53.00

*The wetted surface of this product contacted by consumable water contains less than 0.25% of lead by weight.

Consult factory for ordering code numbers of special models/options.

Brass Fittings

1

Brass Fittings

Model	Ordering Code	Size & Connection	UPC	Unit Pack Qty.	(Inner Ctn.) Minimum Order Qty.	Master Carton Qty.	Unit Weight (lbs.)	List Price Unit Pack
-------	---------------	-------------------	-----	----------------	---------------------------------	--------------------	--------------------	----------------------

Brass Elbows

Elbows

Package Type: Single Pack



LF4717

LEAD FREE	LF4717-08	0472061	3/8" CTS	098268040876	1	6	60	0.12	\$ 19.50
	LF4717-10	0472016	1/2" CTS	098268022056	1	12	120	0.17	19.50
	LF4717-14	0472017	3/4" CTS	098268022070	1	12	120	0.3	23.00
	LF4717-18	0472018	1" CTS	098268022087	1	6	60	0.48	39.25

Package Type: Bulk Pack

LEAD FREE	LF4717-10CP	0472066	1/2" CTS	098268145816	5	5	5	1.35	111.50
	LF4717-14CP	0472067	3/4" CTS	098268145861	5	5	5	2.35	94.50

Reducing Elbows

Package Type: Single Pack



LF4717R

LEAD FREE	LF4717R-1410	0472019	3/4" x 1/2" CTS	098268022094	1	12	120	0.21	22.75
	LF4717R-1814	0472020	1" x 3/4" CTS	098268022100	1	6	60	0.4	38.25

Stackable Elbows

Package Type: Single Pack



LF4718

LEAD FREE	LF4718-10	0472021	1/2" CTS	098268022117	1	6	60	0.17	19.25
	LF4718-14	0472022	3/4" CTS	098268022124	1	6	60	0.3	25.00
	LF4718-18	0472023	1" CTS	098268022131	1	6	60	0.48	38.00

Male Elbows

Package Type: Single Pack



LF4719

LEAD FREE	LF4719-1008	0472025	1/2" CTS x 1/2" NPT	098268022155	1	6	60	0.2	20.25
	LF4719-1412	0472026	3/4" CTS x 3/4" NPT	098268022162	1	6	60	0.3	30.75

Female Elbows

Package Type: Single Pack



LF4720

LEAD FREE	LF4720-1008	0472028	1/2" CTS x 1/2" NPT	098268022193	1	6	60	0.2	20.25
	LF4720-1412	0472029	3/4" CTS x 3/4" NPT	098268022209	1	6	60	0.3	32.50

Drop Ear Elbows

Package Type: Single Pack



LF4721

LEAD FREE	LF4721-1008	0472034	1/2" CTS x 1/2" FPT	098268022308	1	6	60	0.23	17.25
-----------	-------------	---------	---------------------	--------------	---	---	----	------	-------

Elbow 45°

Package Type: Single Pack



LF4722

LEAD FREE	LF4722-14	0472032	3/4" CTS 45°	098268022278	1	6	60	0.3	25.50
	LF4722-18	0472033	1" CTS 45°	098268022292	1	6	60	0.48	38.00

*The wetted surface of this product contacted by consumable water contains less than 0.25% of lead by weight.

Consult factory for ordering code numbers of special models/options.

Model	Ordering Code	Size & Connection	UPC	Unit Pack Qty.	(Inner Ctn.) Minimum Order Qty.	Master Carton Qty.	Unit Weight (lbs.)	List Price Unit Pack
-------	---------------	-------------------	-----	----------------	---------------------------------	--------------------	--------------------	----------------------

Brass Connectors

Couplings

Package Type: Single Pack

LEAD FREE*	LF4715-08	0472060	3/8" CTS	098268040845	1	6	60	0.12	\$ 19.50
	LF4715-10	0472000	1/2" CTS	098268021806	1	12	120	0.14	19.50
	LF4715-14	0472001	3/4" CTS	098268021837	1	12	120	0.23	20.75
	LF4715-18	0472002	1" CTS	098268021851	1	6	60	0.33	38.25

Package Type: Bulk Pack

LEAD FREE*	LF4715-10CP	0472064	1/2" CTS	098268145762	5	5	5	0.6	93.75
	LF4715-14CP	0472065	3/4" CTS	098268145786	5	5	5	0.95	99.50

Reducing Couplings

Package Type: Single Pack

LEAD FREE*	LF4715R-1410	0472003	3/4" CTS x 1/2" CTS	098268021868	1	12	120	0.2	20.25
	LF4715R-1814	0472004	1" CTS x 3/4" CTS	098268021875	1	6	60	0.3	47.00

Male Adapters

Package Type: Single Pack

LEAD FREE*	LF4701-0806	0472058	3/8" CTS x 3/8" NPT	098268040814	1	6	60	0.12	14.50
	LF4701-1008	0472011	1/2" CTS x 1/2" NPT	098268021981	1	12	120	0.13	14.50
	LF4701-1012	0472012	1/2" CTS x 3/4" NPT	098268022001	1	6	60	0.18	19.50
	LF4701-1412	0472013	3/4" CTS x 3/4" NPT	098268022018	1	12	120	0.2	16.50
	LF4701-1816	0472015	1" CTS x 1" NPT	098268022032	1	6	60	0.28	29.25

Package Type: Bulk Pack

LEAD FREE*	LF4701-1008CP	0472085	1/2" CTS x 1/2" NPT	098268186680	5	5	5	0.13	68.50
	LF4701-1412CP	0472089	3/4" CTS x 3/4" NPT	098268186734	5	5	5	0.2	80.00

Female Adapters

Package Type: Single Pack

LEAD FREE*	LF4710-0806	0472059	3/8" CTS x 3/8" FNPT	098268040821	1	6	60	0.11	14.50
	LF4710-1008	0472005	1/2" CTS x 1/2" FNPT	098268021905	1	12	120	0.14	14.50
	LF4710-1012	0472006	1/2" CTS x 3/4" FNPT	098268021912	1	6	60	0.2	19.50
	LF4710-1408	0472062	3/4" CTS x 1/2" FNPT	098268043297	1	6	60	0.2	19.50
	LF4710-1412	0472007	3/4" CTS x 3/4" FNPT	098268021929	1	6	60	0.21	16.50
	LF4710-1416	0472008	3/4" CTS x 1" FNPT	098268021936	1	6	60	0.22	19.50
	LF4710-1816	0472010	1" CTS x 1" FNPT	098268021974	1	6	60	0.3	29.25
	LF4710-0417	0472071	1/4" OD x 3/8" CMP	098268146813	1	5	50	0.45	23.00
	LF4710-0617	0472072	3/8" OD x 3/8" CMP	098268146820	1	5	50	0.5	23.00

Package Type: Bulk Pack

LEAD FREE*	LF4710-1008CP	0472086	1/2" CTS x 1/2" NPT	098268186703	5	5	5	0.14	68.50
	LF4710-1412CP	0472090	3/4" CTS x 3/4" NPT	098268186741	5	5	5	0.21	80.00

Slip Repair Couplings

Package Type: Single Pack

LEAD FREE*	LF4716-10	0472047	1/2" CTS	098268022506	1	12	120	0.25	28.25
	LF4716-14	0472048	3/4" CTS	098268022520	1	6	60	0.39	35.25
	LF4716-18	0472049	1" CTS	098268022537	1	6	60	0.55	49.00



LF4715



LF4715R



LF4701



LF4710



LF4716

*The wetted surface of this product contacted by consumable water contains less than 0.25% of lead by weight.

Consult factory for ordering code numbers of special models/options.

Brass Fittings

1

Brass Fittings

Model	Ordering Code	Size & Connection	UPC	Unit Pack Qty.	(Inner Ctn.) Minimum Order Qty.	Master Carton Qty.	Unit Weight (lbs.)	List Price Unit Pack
-------	---------------	-------------------	-----	----------------	---------------------------------	--------------------	--------------------	----------------------

Brass Stems

Male Stems

Package Type: Single Pack



LF4727

LEAD FREE	LF4727-1003	0472068	1/2" CTS x 1/2" NPT	098268145908	1	5	50	0.19	\$ 32.00
LEAD FREE	LF4727-1412	0472056	3/4" CTS x 3/4" NPT	098268022698	1	5	50	0.4	36.25

Female Stems

Package Type: Single Pack



LF4728

LEAD FREE	LF4728-1008	0472069	1/2" CTS x 1/2" NPT	098268145915	1	5	50	0.13	32.00
LEAD FREE	LF4728-1412	0472057	3/4" CTS x 3/4" NPT	098268022780	1	5	50	0.31	16.50

Brass Ends

End Caps

Package Type: Single Pack



LF4745

LEAD FREE	LF4745-10	0472044	1/2" CTS	098268340679	1	12	120	0.09	15.75
LEAD FREE	LF4745-14	0472045	3/4" CTS	098268340686	1	6	60	0.14	19.75
LEAD FREE	LF4745-18	0472046	1" CTS	098268340693	1	6	60	0.21	38.25

Package Type: Bulk Pack

LEAD FREE	LF4745-10CP	0472087	1/2" CTS	098268186727	5	5	5	0.09	76.00
LEAD FREE	LF4745-14CP	0472091	3/4" CTS	098268186789	5	5	5	0.14	95.50

Brass Valves

Ball Valves

Package Type: Single Pack



LF47FBVQC

LEAD FREE	LF47FBVQC-10	0472053	1/2" CTS	098268022667	1	6	60	0.44	32.00
LEAD FREE	LF47FBVQC-14	0472054	3/4" CTS	098268022674	1	6	60	0.63	43.25
LEAD FREE	LF47FBVQC-18	0472055	1" CTS	098268022681	1	6	60	1.17	74.00

Tee Valves

Package Type: Single Pack

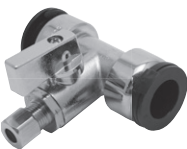

LF4750

LEAD FREE	LF4750-101004	0472075	1/2" x 1/2" CTS x 1/4" OD	098268147667	1	5	50	0.315	57.25
LEAD FREE	LF4750-101006	0472076	1/2" x 1/2" CTS x 3/8" OD	098268147674	1	5	50	0.315	57.25
LEAD FREE	LF4750-141404	0472077	3/4" x 3/4" CTS x 1/4" OD	098268147681	1	5	50	0.44	79.00
LEAD FREE	LF4750-141406	0472078	3/4" x 3/4" CTS x 3/8" OD	098268147698	1	5	50	0.44	79.00

Washing Machine Valves

Package Type: Single Pack



LF4751

LEAD FREE	LF4751-1014S	0472079	1/2" CTS x 3/4" GHT	098268180183	1	5	50	0.315	23.50
LEAD FREE	LF4751-1014A	0472080	1/2" CTS x 3/4" GHT	098268180190	1	5	50	0.315	25.50

Garden Hose Valves

Package Type: Single Pack



LF4751

LEAD FREE	LF4751-1014D	0472081	1/2" CTS x 3/4" GHT	098268180220	1	5	50	0.315	34.25
LEAD FREE	LF4751-1414D	0472082	3/4" CTS x 3/4" GHT	098268180237	1	5	50	0.315	38.00
LEAD FREE	LF4751-1014HB	0472083	1/2" CTS x 3/4" GHT	098268180282	1	5	50	0.44	41.50
LEAD FREE	LF4751-1414HB	0472084	3/4" CTS x 3/4" GHT	098268180305	1	5	50	0.44	44.50

*The wetted surface of this product contacted by consumable water contains less than 0.25% of lead by weight.

Consult factory for ordering code numbers of special models/options.

Model	Ordering Code	Size & Connection	UPC	Unit Pack Qty.	(Inner Ctn.) Minimum Order Qty.	Master Carton Qty.	Unit Weight (lbs.)	List Price Unit Pack
-------	---------------	-------------------	-----	----------------	---------------------------------	--------------------	--------------------	----------------------

Plastic Fitting Tees

Tees

Package Type: Single Pack



3523-10

LEAD FREE*	3523-08	0959038	3/8" x 3/8" x 3/8" CTS	098268298697	1	5	60	0.05	\$ 14.75
	3523-10	0959094	1/2" x 1/2" x 1/2" CTS	098268299458	1	5	30	0.08	16.00
	3523-14	0959139	3/4" x 3/4" x 3/4" CTS	098268299939	1	5	15	0.14	27.50
	3523-18	0959297	1" x 1" x 1" CTS	098268346596	1	5	15	0.20	40.25

Package Type: Bulk Pack

LEAD FREE*	3523-08CP	81902960	3/8" x 3/8" x 3/8" CTS	840213003142	10	10	120	0.05	122.50
	3523-10CP	81902961	1/2" x 1/2" x 1/2" CTS	840213003159	10	10	80	0.08	132.50
	3523-14CP	81902963	3/4" x 3/4" x 3/4" CTS	840213003166	5	5	40	0.14	113.75
	3523-18CP	81902965	1" x 1" x 1" CTS	840213003173	5	5	25	0.20	166.25

Reducing Tees

Package Type: Single Pack



3524R-141410

LEAD FREE*	3524R-101004	0959095	1/2" CTS x 1/2" CTS x 1/4" OD	098268299465	1	5	30	0.08	24.00
	3524R-141410	0959140	3/4" x 3/4" x 1/2" CTS	098268299946	1	5	15	0.14	25.75
	3524R-181814	0959796	1" x 1" x 3/4" CTS	098268050738	1	5	15	0.18	34.25

Package Type: Bulk Pack

LEAD FREE*	3524R-101004CP	81902967	1/2" CTS x 1/2" CTS x 1/4" OD	840213003180	10	10	80	0.08	197.50
	3524R-141410CP	81902968	3/4" x 3/4" x 1/2" CTS	840213003197	5	5	50	0.14	107.50
	3524R-181814CP	81902969	1" x 1" x 3/4" CTS	840213003203	5	5	30	0.18	142.50

Double Reducing Tees

Package Type: Single Pack

LEAD FREE*	3526R-141010	0959340	3/4" x 1/2" x 1/2" CTS	098268966213	1	5	30	0.11	22.75
------------	--------------	---------	------------------------	--------------	---	---	----	------	-------

Package Type: Bulk Pack

LEAD FREE*	3526R-141010CP	81902970	3/4" x 1/2" x 1/2" CTS	840213003210	10	10	80	0.11	190.00
------------	----------------	----------	------------------------	--------------	----	----	----	------	--------

Male Threaded Tees

Package Type: Single Pack

LEAD FREE*	3530-1008	0959406	1/2" x 1/2" x 1/2" NPT	098268533392	1	5	30	0.09	15.00
------------	-----------	---------	------------------------	--------------	---	---	----	------	-------

Package Type: Bulk Pack

LEAD FREE*	3530-1008CP	81902973	1/2" x 1/2" x 1/2" NPT	840213003241	10	10	80	0.09	125.00
------------	-------------	----------	------------------------	--------------	----	----	----	------	--------

Stackable Tees

Package Type: Single Pack



3533-10

LEAD FREE*	3533-08	0959039	3/8" x 3/8" x 3/8" CTS	098268298703	1	5	60	0.04	12.00
	3533-10	0959097	1/2" x 1/2" x 1/2" CTS	098268299489	1	5	30	0.07	13.75
	3533-14	0959142	3/4" x 3/4" x 3/4" CTS	098268299960	1	5	15	0.13	23.75
	3533-18	0959797	1" x 1" x 1" CTS	098268050745	1	5	15	0.18	32.00

Package Type: Bulk Pack

LEAD FREE*	3533-08CP	81902974	3/8" x 3/8" x 3/8" CTS	840213003258	10	10	120	0.04	100.00
	3533-10CP	81902975	1/2" x 1/2" x 1/2" CTS	840213003265	10	10	100	0.07	112.50
	3533-14CP	81902977	3/4" x 3/4" x 3/4" CTS	840213003272	5	5	40	0.13	97.50
	3533-18CP	81902978	1" x 1" x 1" CTS	840213003289	5	5	25	0.18	131.25

*The wetted surface of this product contacted by consumable water contains less than 0.25% of lead by weight.

Consult factory for ordering code numbers of special models/options.

Plastic Fittings

Model	Ordering Code	Size & Connection	UPC	Unit Pack Qty.	(Inner Ctn.) Minimum Order Qty.	Master Carton Qty.	Unit Weight (lbs.)	List Price Unit Pack
-------	---------------	-------------------	-----	----------------	---------------------------------	--------------------	--------------------	----------------------

Plastic Fitting Tees (continued)

Reducing Stackable Tees

Package Type: Single Pack

LEAD FREE	3533R-1004	0959470	1/2" CTS x 1/2" CTS x 1/4" OD	098268089202	1	5	30	0.07	\$ 21.50
	3533R-1410	0959476	3/4" x 3/4" x 1/2" CTS	098268089387	1	5	15	0.10	20.25

Package Type: Bulk Pack

LEAD FREE	3533R-1004CP	81902980	1/2" CTS x 1/2" CTS x 1/4" OD	840213003296	1	1	100	0.07	182.50
	3533R-1410CP	81902981	3/4" x 3/4" x 1/2" CTS	840213003302	1	1	100	0.10	165.00

Stackable Branch Tees

Package Type: Single Pack

LEAD FREE	3534-10	0959342	1/2" x 1/2" x 1/2" CTS	098268966237	1	5	15	0.07	16.75
------------------	---------	---------	------------------------	--------------	---	---	----	------	-------

Package Type: Bulk Pack

LEAD FREE	3534-10CP	81902983	1/2" x 1/2" x 1/2" CTS	840213003319	10	10	100	0.07	137.50
------------------	-----------	----------	------------------------	--------------	----	----	-----	------	--------

*The wetted surface of this product contacted by consumable water contains less than 0.25% of lead by weight.

Consult factory for ordering code numbers of special models/options.

Plastic Fittings

Model	Ordering Code	Size & Connection	UPC	Unit Pack Qty.	(Inner Ctn.) Minimum Order Qty.	Master Carton Qty.	Unit Weight (lbs.)	List Price Unit Pack
-------	---------------	-------------------	-----	----------------	---------------------------------	--------------------	--------------------	----------------------

Plastic Fitting Elbows

Elbows

Package Type: Single Pack



3517-18

LEAD FREE	3517-08	0959035	3/8" CTS	098268298598	1	5	60	0.04	\$ 11.25
	3517-10	0959087	1/2" CTS	098268299342	1	5	30	0.06	13.75
	3517-14	0959138	3/4" CTS	098268299915	1	5	25	0.11	19.50
	3517-18	0959300	1" CTS	098268346657	1	5	15	0.15	31.75

Package Type: Bulk Pack

LEAD FREE	3517-08CP	81902933	3/8" CTS	840213002985	10	10	200	0.04	95.00
	3517-10CP	81902934	1/2" CTS	840213002992	10	10	100	0.06	112.50
	3517-14CP	81902936	3/4" CTS	840213003005	10	10	50	0.11	162.50
	3517-18CP	81902939	1" CTS	840213003012	5	5	40	0.15	130.00

Reducing Elbow

Package Type: Single Pack

LEAD FREE	3517R-1410	0959339	3/4 CTS x 1/2 CTS	098268966206	1	5	15	11.5	20.50
-----------	------------	---------	-------------------	--------------	---	---	----	------	-------

Stackable Elbows

Package Type: Single Pack



3518-10

LEAD FREE	3518-08	0959036	3/8" CTS	098268298604	1	5	60	0.03	8.50
	3518-10	0959096	1/2" CTS	098268299472	1	5	60	0.04	12.25
	3518-14	0959141	3/4" CTS	098268299953	1	5	15	0.05	15.50
	3518-18	0959794	1" CTS	098268050714	1	5	30	0.12	23.75

Package Type: Bulk Pack

LEAD FREE	3518-08CP	81902940	3/8" CTS	840213003029	10	10	200	0.03	70.00
	3518-10CP	81902941	1/2" CTS	840213003036	10	10	100	0.04	102.50
	3518-14CP	81902943	3/4" CTS	840213003043	10	10	80	0.05	127.50
	3518-18CP	81902945	1" CTS	840213003050	5	5	30	0.12	97.50

Male Elbows

Package Type: Single Pack



3519-1412

LEAD FREE	3519-1006	0959089	1/2" CTS x 3/8" NPT	098268299366	1	5	60	0.04	12.25
	3519-1008	0959088	1/2" CTS x 1/2" NPT	098268299359	1	5	60	0.04	12.00
	3519-1412	0959791	3/4" CTS x 3/4" NPT	098268040920	1	5	30	0.10	17.25
	3519-1816	0959795	1" CTS x 1" NPT	098268050721	1	5	15	0.12	23.50

Package Type: Bulk Pack

LEAD FREE	3519-1006CP	81902947	1/2" CTS x 3/8" NPT	840213003067	10	10	100	0.04	102.50
	3519-1008CP	81902948	1/2" CTS x 1/2" NPT	840213003074	10	10	100	0.04	100.00
	3519-1816CP	81902949	1" CTS x 1" NPT	840213003081	5	5	50	0.12	96.50

*The wetted surface of this product contacted by consumable water contains less than 0.25% of lead by weight.

Consult factory for ordering code numbers of special models/options.

Plastic Fittings

Model	Ordering Code	Size & Connection	UPC	Unit Pack Qty.	(Inner Ctn.) Minimum Order Qty.	Master Carton Qty.	Unit Weight (lbs.)	List Price Unit Pack
-------	---------------	-------------------	-----	----------------	---------------------------------	--------------------	--------------------	----------------------

Plastic Fitting Elbows (continued)

Female Swivel Elbows

Package Type: Single Pack



3520-1014

LEAD FREE	3520-0808	0959037	3/8" CTS x 1/2" NPS	098268298611	1	5	60	0.04	\$ 12.25
	3520-0813	0959043	3/8" CTS x 7/8" BC	098268298741	1	5	60	0.04	19.25
	3520-1008	0959090	1/2" CTS x 1/2" NPS	098268299373	1	5	30	0.06	13.75
	3520-1012	0959091	1/2" CTS x 3/4" NPS	098268299380	1	5	30	0.06	15.50
	3520-1013	0959093	1/2" CTS x 7/8" BC	098268299441	1	5	30	0.10	14.75
	3520-1014	0959293	1/2" CTS x 3/4" FGHT	098268343854	1	5	30	0.06	19.00
	3520-1412	0959792	3/4" CTS x 3/4" NPT	098268040937	1	5	30	0.10	19.50

Package Type: Bulk Pack

LEAD FREE	3520-0808CP	81902950	3/8" CTS x 1/2" NPS	840213003098	10	10	100	0.04	102.50
	3520-1008CP	81902952	1/2" CTS x 1/2" NPS	840213003104	10	10	100	0.06	112.50
	3520-1012CP	81902955	1/2" CTS x 3/4" NPS	840213003111	10	10	100	0.08	127.50
	3520-1014CP	81902957	1/2" CTS x 3/4" FGHT	840213003128	10	10	100	0.06	157.50

Drop Ear Elbows

Package Type: Single Pack



3521-1008

LEAD FREE	3521-1008	0959092	1/2" CTS x 1/2" NPT	098268299397	1	5	30	0.07	16.00
-----------	-----------	---------	---------------------	--------------	---	---	----	------	-------

Package Type: Bulk Pack

LEAD FREE	3521-1008CP	81902958	1/2" CTS x 1/2" NPT	840213003135	10	10	80	0.07	132.50
-----------	-------------	----------	---------------------	--------------	----	----	----	------	--------

Hose Barb Elbows

Package Type: Single Pack

LEAD FREE	3512-1008	0959472	1/2" CTS x 1/2" HB	098268089240	1	5	60	0.02	6.50
-----------	-----------	---------	--------------------	--------------	---	---	----	------	------

Package Type: Bulk Pack

LEAD FREE	3512-1008CP	81902902	1/2" CTS x 1/2" HB	840213002831	10	10	200	0.02	55.00
-----------	-------------	----------	--------------------	--------------	----	----	-----	------	-------

Elbow Pump Adapter

Package Type: Bulk Pack

LEAD FREE	3576-10CP	81903041	1/2" CTS	840213003876	10	10	100	0.05	95.00
-----------	-----------	----------	----------	--------------	----	----	-----	------	-------

*The wetted surface of this product contacted by consumable water contains less than 0.25% of lead by weight.

Consult factory for ordering code numbers of special models/options.

Model	Ordering Code	Size & Connection	UPC	Unit Pack Qty.	(Inner Ctn.) Minimum Order Qty.	Master Carton Qty.	Unit Weight (lbs.)	List Price Unit Pack
-------	---------------	-------------------	-----	----------------	---------------------------------	--------------------	--------------------	----------------------

Plastic Fitting Connectors

Couplings

Package Type: Single Pack



3515-18

LEAD FREE	3515-08	0959032	3/8" CTS	098268298550	1	5	60	0.03	\$ 12.25
	3515-10	0959079	1/2" CTS	098268299267	1	5	60	0.05	14.75
	3515-14	0959133	3/4" CTS	098268299861	1	5	30	0.09	19.50
	3515-18	0959299	1" CTS	098268346640	1	5	30	0.13	28.50

Package Type: Bulk Pack

LEAD FREE	3515-08CP	81902913	3/8" CTS	840213002909	10	10	200	0.03	102.50
	3515-10CP	81902914	1/2" CTS	840213002916	10	10	100	0.05	122.50
	3515-14CP	81902916	3/4" CTS	840213002923	10	10	60	0.09	162.50
	3515-18CP	81902918	1" CTS	840213002930	5	5	40	0.13	117.50

Reducing Couplings

Package Type: Single Pack



3515R-1004

LEAD FREE	3515R-1004	0959080	1/2" CTS x 1/4" OD	098268299274	1	5	60	0.05	19.00
	3515R-1008	0959081	1/2" CTS x 3/8" CTS	098268299281	1	5	60	0.04	13.75
	3515R-1410	0959134	3/4" CTS x 1/2" CTS	098268299878	1	5	30	0.08	16.00
	3515R-1814	0959793	1" CTS x 3/4" CTS	098268050707	1	5	30	0.11	22.75

Package Type: Bulk Pack

LEAD FREE	3515R-1004CP	81902924	1/2" CTS x 1/4" OD	840213002947	10	10	100	0.05	157.50
	3515R-1008CP	81902925	1/2" CTS x 3/8" CTS	840213002954	10	10	100	0.04	112.50
	3515R-1410CP	81902926	3/4" CTS x 1/2" CTS	840213002961	10	10	100	0.08	132.50
	3515R-1814CP	81902927	1" CTS x 3/4" CTS	840213002978	5	5	40	0.11	95.00

Male Adapters

Package Type: Single Pack



3501-1412

LEAD FREE	3501-0806	0959033	3/8" CTS x 3/8" NPT	098268298567	1	5	60	0.02	8.50
	3501-1006	0959269	1/2" CTS x 3/8" NPT	098268338447	1	5	60	0.03	10.50
	3501-0808	0959034	3/8" CTS x 1/2" NPT	098268298574	1	5	60	0.03	10.00
	3501-1008	0959083	1/2" CTS x 1/2" NPT	098268299304	1	5	60	0.04	11.25
	3501-1012	0959084	1/2" CTS x 3/4" NPT	098268299311	1	5	60	0.04	15.00
	3501-1412	0959136	3/4" CTS x 3/4" NPT	098268299892	1	5	30	0.06	14.75
	3501-1416	0959788	3/4" CTS x 1" NPT	098268040890	1	5	30	0.09	20.50
	3501-1816	0959301	1" CTS x 1" NPT	098268346664	1	5	30	0.11	21.50

Package Type: Bulk Pack



3501-1816

LEAD FREE	3501-0806CP	81902877	3/8" CTS x 3/8" NPT	840213002671	10	10	100	0.02	70.00
	3501-1006CP	81902879	1/2" CTS x 3/8" NPT	840213002695	10	10	100	0.03	85.00
	3501-0808CP	81902878	3/8" CTS x 1/2" NPT	840213002688	10	10	200	0.03	82.50
	3501-1008CP	81902880	1/2" CTS x 1/2" NPT	840213002701	10	10	100	0.04	95.00
	3501-1012CP	81902882	1/2" CTS x 3/4" NPT	840213002718	10	10	100	0.04	125.00
	3501-1014CP	81902883	1/2" CTS x 3/4" GHT	840213002725	10	10	100	0.04	125.00
	3501-1412CP	81902885	3/4" CTS x 3/4" NPT	840213002732	10	10	100	0.06	122.50
	3501-1416CP	81906544	3/4" CTS x 1" NPT	098268131543	10	10	100	0.09	167.50
	3501-1816CP	81902887	1" CTS x 1" NPT	840213002749	5	5	50	0.11	91.25

*The wetted surface of this product contacted by consumable water contains less than 0.25% of lead by weight.

Consult factory for ordering code numbers of special models/options.

Plastic Fittings

Model	Ordering Code	Size & Connection	UPC	Unit Pack Qty.	(Inner Ctn.) Minimum Order Qty.	Master Carton Qty.	Unit Weight (lbs.)	List Price Unit Pack
-------	---------------	-------------------	-----	----------------	---------------------------------	--------------------	--------------------	----------------------

Plastic Fitting Connectors (continued)

Female Swivel Adapters

Package Type: Single Pack



3510-1008

3510-0808	0959790	3/8" CTS x 1/2" NPS	098268040913	1	5	60	0.04	\$ 11.50
3510-1008	0959085	1/2" CTS x 1/2" NPS	098268299328	1	5	60	0.04	12.00
3510-1012	0959086	1/2" CTS x 3/4" NPS	098268299335	1	5	30	0.06	15.50
3510-1013	0959292	1/2" CTS x 3/4" Closet	098268343847	1	5	30	0.06	14.75
3510-1014	0959235	1/2" CTS x 3/4" FGHT	098268965148	1	5	30	0.08	19.00
3510-1412	0959137	3/4" CTS x 3/4" NPS	098268299908	1	5	30	0.08	18.50
3510-1416	0959789	3/4" CTS x 1" NPS	098268040906	1	5	30	0.09	20.50
3510-1816	0959298	1" CTS x 1" NPS	098268346633	1	5	30	0.11	22.75

Package Type: Bulk Pack



3510-1013

3510-0808CP	81902888	3/8" CTS x 1/2" NPS	840213002756	10	10	100	0.04	112.50
3510-0814CP	81902890	3/8" CTS x 1/2" FGHT	840213002763	10	10	100	0.06	112.50
3510-1008CP	81902891	1/2" CTS x 1/2" NPS	840213002770	10	10	100	0.04	112.50
3510-1012CP	81902894	1/2" CTS x 3/4" NPS	840213002787	10	10	100	0.06	127.50
3510-1013CP	81902895	1/2" CTS x 3/4" Closet	840213002794	10	10	100	0.06	157.50
3510-1014CP	81902896	1/2" CTS x 3/4" FGHT	840213002800	10	10	100	0.08	155.00
3510-1412CP	81902897	3/4" CTS x 3/4" NPS	840213002817	10	10	100	0.08	157.50
3510-1816CP	81902899	1" CTS x 1" NPS	840213002824	5	5	80	0.11	95.00

Hose Barb Stems

Package Type: Single Pack

LEAD FREE*	3511-1008	0959471	1/2" CTS x 1/2" Barb	098268089219	1	6	540	0.3	6.25
------------	-----------	---------	----------------------	--------------	---	---	-----	-----	------

Package Type: Bulk Pack

LEAD FREE*	3511-1008CP	81906548	1/2" CTS x 1/2" Barb	098628068535	10	200	2,000	0.3	47.50
------------	-------------	----------	----------------------	--------------	----	-----	-------	-----	-------

Hose Barb Adapters

Package Type: Single Pack



3513

LEAD FREE*	3513-1008	0959291	1/2" CTS x 1/2" HB	098268089219	1	5	60	0.04	11.50
3513-1412	0959477	3/4" CTS x 3/4" HB	098268089394	1	5	30	0.06	17.25	
3513-1816	0959478	1" CTS x 1" HB	098268089417	1	5	30	0.09	19.50	

Package Type: Bulk Pack

LEAD FREE*	3513-1008CP	81902904	1/2" CTS x 1/2" HB	840213002848	10	10	100	0.04	97.50
3513-1412CP	81902906	3/4" CTS x 3/4" Barb	840213002855	10	10	100	0.06	145.00	

Pump Adapters

Package Type: Bulk Pack

LEAD FREE*	3575-10CP	81903040	1/2" CTS	840213003586	10	10	100	0.04	95.00
------------	-----------	----------	----------	--------------	----	----	-----	------	-------

*The wetted surface of this product contacted by consumable water contains less than 0.25% of lead by weight.

Consult factory for ordering code numbers of special models/options.

Model	Ordering Code	Size & Connection	UPC	Unit Pack Qty.	(Inner Ctn.) Minimum Order Qty.	Master Carton Qty.	Unit Weight (lbs.)	List Price Unit Pack
-------	---------------	-------------------	-----	----------------	---------------------------------	--------------------	--------------------	----------------------

Plastic Fitting Stems

Male Stems

Package Type: Single Pack

LEAD FREE*	3527-1008	0959365	1/2" CTS x 1/2" NPT	098268460391	1	5	30	0.02	\$ 6.50
-------------------	-----------	---------	---------------------	--------------	---	---	----	------	---------

Package Type: Bulk Pack

LEAD FREE*	3527-1008CP	81902971	1/2" CTS x 1/2" NPT	840213003227	10	10	200	0.02	55.00
LEAD FREE*	3527-1416CP	81906542	3/4" CTS x 1" NPT	098268131543	10	10	80	0.09	75.00

Female Stems

Package Type: Single Pack

	3528-1008	0959364	1/2" CTS x 1/2" NPS	098268460384	1	5	60	0.03	7.75
--	-----------	---------	---------------------	--------------	---	---	----	------	------

Package Type: Bulk Pack

	3528-1008CP	81902972	1/2" CTS x 1/2" NPS	840213003234	10	10	150	0.03	67.50
--	-------------	----------	---------------------	--------------	----	----	-----	------	-------

Reducing Stems

Package Type: Single Pack

LEAD FREE*	3514-1008	0959082	1/2" CTS x 3/8" CTS	098268299298	1	5	60	0.03	11.00
LEAD FREE*	3514-1410	0959135	3/4" CTS x 1/2" CTS	098268299885	1	5	30	0.04	11.50
LEAD FREE*	3514-1810	0959407	1" CTS x 1/2" CTS	098268533408	1	5	30	0.05	13.75
LEAD FREE*	3514-1814	0959294	1" CTS x 3/4" CTS	098268346565	1	5	30	0.07	18.50

Package Type: Bulk Pack

LEAD FREE*	3514-1008CP	81902908	1/2" CTS x 3/8" CTS	840213002862	10	10	100	0.03	87.50
LEAD FREE*	3514-1410CP	81902909	3/4" CTS x 1/2" CTS	840213002879	10	10	100	0.04	97.50
LEAD FREE*	3514-1810CP	81902911	1" CTS x 1/2" CTS	840213002886	5	5	50	0.05	66.25
LEAD FREE*	3514-1814CP	81902912	1" CTS x 3/4" CTS	840213002893	5	5	50	0.07	77.50

Hose Barb Stems

Package Type: Bulk Pack

LEAD FREE*	3511-1008	81906548	1/2" CTS	098268068535	200	200	2000	0.02	47.50
-------------------	-----------	----------	----------	--------------	-----	-----	------	------	-------

Plastic Fitting Ends

End Caps

Package Type: Single Pack

LEAD FREE*	3545-08	0959042	3/8" CTS	098268298734	1	5	60	0.02	11.50
LEAD FREE*	3545-10	0959109	1/2" CTS	098268299618	1	5	60	0.03	11.50
LEAD FREE*	3545-14	0959145	3/4" CTS	098268299991	1	5	30	0.06	15.00
LEAD FREE*	3545-18	0959263	1" CTS	098268338386	1	5	30	0.08	18.00

Package Type: Bulk Pack

LEAD FREE*	3545-08CP	81902997	3/8" CTS	840213003401	10	10	200	0.02	97.50
LEAD FREE*	3545-10CP	81902998	1/2" CTS	840213003418	10	10	200	0.03	97.50
LEAD FREE*	3545-14CP	81903000	3/4" CTS	840213003425	10	10	100	0.06	125.00
LEAD FREE*	3545-18CP	81903002	1" CTS	840213003432	5	5	50	0.08	73.75



3514-1410



3545-10



3545-14

*The wetted surface of this product contacted by consumable water contains less than 0.25% of lead by weight.

Consult factory for ordering code numbers of special models/options.

Plastic Fittings

Model	Ordering Code	Size & Connection	UPC	Unit Pack Qty.	(Inner Ctn.) Minimum Order Qty.	Master Carton Qty.	Unit Weight (lbs.)	List Price Unit Pack
-------	---------------	-------------------	-----	----------------	---------------------------------	--------------------	--------------------	----------------------

Plastic Valves

Straight Valves

Package Type: Single Pack



3539-10

LEAD FREE	3539-08	0959040	3/8" CTS	098268298710	1	5	30	0.08	\$ 21.75
	3539-10	0959098	1/2" CTS	098268299496	1	5	15	0.11	20.50
	3539R-1004	0959099	1/2" CTS x 1/4" OD	098268299502	1	5	15	0.11	26.50
	3539-14	0959144	3/4" CTS	098268299984	1	5	15	0.19	32.50
	3539-18	0959798	1" CTS	098268050752	1	5	15	0.25	40.25

Package Type: Bulk Pack



3539-14

LEAD FREE	3539-08CP	81902987	3/8" CTS	840213003333	10	10	100	0.08	215.00
	3539-10CP	81902988	1/2" CTS	840213003340	10	10	80	0.11	197.50
	3539R-1004CP	81902992	1/2" CTS x 1/4" OD	840213003364	10	10	80	0.11	257.50
	3539-14CP	81902990	3/4" CTS	840213003357	5	5	40	0.19	158.75
	3539-18CP	81902991	1" CTS	840213003968	5	5	20	0.25	195.00

Collet Covers

Package Type: Single Pack

LEAD FREE	3555-1006	0959185	1/2" CTS x 1/4" CTS	098268322651	1	5	30	0.20	21.00
	3555-1008	0959191	1/2" CTS x 3/8" CTS	098268326772	1	5	15	0.60	20.50

Female Straight Valves

Package Type: Single Pack

LEAD FREE	3552-0806	0959186	1/2" NPS x 1/4" CTS	098268322668	1	5	30	0.08	16.50
	3552-0808	0959187	1/2" NPS x 3/8" CTS	098268322675	1	5	30	0.08	17.50

Stackable Valves

Package Type: Single Pack

LEAD FREE	3543-10	0959366	1/2" CTS	098268462661	1	5	30	0.11	16.50
	3543R-1004	0959367	1/2" CTS x 1/4" OD	098268463293	1	5	30	0.16	22.50

Package Type: Bulk Pack

LEAD FREE	3543-10CP	81902995	1/2" CTS	840213003395	10	10	80	0.11	162.50
-----------	-----------	----------	----------	--------------	----	----	----	------	--------

Tee Valves

Package Type: Single Pack

LEAD FREE	3550-1004	0959358	1/2" CTS x 1/4" OD	098268443547	1	5	15	0.09	28.50
-----------	-----------	---------	--------------------	--------------	---	---	----	------	-------

Package Type: Bulk Pack

LEAD FREE	3550-1004CP	81903009	1/2" CTS x 1/4" OD	840213003494	10	10	80	0.09	235.00
	3550-0404CP	81906441	1/4" OD x 1/4" OD	840213003678	10	10	80	0.09	210.00
	3550-1404CP	81906403	3/4" CTS x 1/4" OD	840213003951	5	5	40	0.15	122.50

Check Valves

Package Type: Single Pack

LEAD FREE	3540-10	0959475	1/2" CTS	098268089370	1	5	30	0.06	13.25
-----------	---------	---------	----------	--------------	---	---	----	------	-------

Package Type: Bulk Pack

LEAD FREE	3540-10CP	81902993	1/2" CTS	840213003371	10	10	80	0.06	130.00
-----------	-----------	----------	----------	--------------	----	----	----	------	--------

*The wetted surface of this product contacted by consumable water contains less than 0.25% of lead by weight.

Consult factory for ordering code numbers of special models/options.

Model	Ordering Code	Size & Connection	UPC	Unit Pack Qty.	(Inner Ctn.) Minimum Order Qty.	Master Carton Qty.	Unit Weight (lbs.)	List Price Unit Pack
-------	---------------	-------------------	-----	----------------	---------------------------------	--------------------	--------------------	----------------------

Plastic Valves (continued)

3-Way Selector Valves

Package Type: Single Pack

LEAD FREE*	3538-10	0959473	1/2" CTS	098268089318	1	5	15	0.14	\$ 34.00
-------------------	---------	---------	----------	--------------	---	---	----	------	----------

Package Type: Bulk Pack

LEAD FREE*	3538-10CP	81902985	1/2" CTS	840213003326	10	10	80	0.14	330.00
-------------------	-----------	----------	----------	--------------	----	----	----	------	--------

3-Way Bypass Valves

Package Type: Single Pack

LEAD FREE*	3541-10	0959474	1/2" CTS	098268089363	1	5	15	0.14	34.00
-------------------	---------	---------	----------	--------------	---	---	----	------	-------

Package Type: Bulk Pack

LEAD FREE*	3541-10CP	81902994	1/2" CTS	840213003388	10	10	80	0.14	330.00
-------------------	-----------	----------	----------	--------------	----	----	----	------	--------

Angle Valves

Package Type: Single Pack

LEAD FREE*	3556-1006	0959182	1/2" CTS x 1/4" CTS	098268322613	1	5	30	0.20	20.75
	3556-1008	0959184	1/2" CTS x 3/8" CTS	098268322644	1	5	30	0.25	20.25
	3557-1408	0959188	1/2" CTS x 3/4" MGHT	098268322682	1	5	30	0.25	21.75

Female Angle Valves

Package Type: Single Pack

LEAD FREE*	3553-0808	0959181	1/2" NPS x 1/4" CTS	098268322576	1	5	30	0.20	18.75
	3553-0608	0959183	1/2" NPS x 3/8" CTS	098268322637	1	5	30	0.12	17.50

Female Angle Valves GHT

Package Type: Single Pack

LEAD FREE*	3554-1408	0959189	1/2" NPS x 3/4" MGHT	098268322699	1	5	30	0.25	23.50
-------------------	-----------	---------	----------------------	--------------	---	---	----	------	-------

Panel Mount Valve

Package Type: Bulk Pack

LEAD FREE*	3559-10CP	81903031	1/2" CTS	840213003531	10	10	80	0.13	102.50
-------------------	-----------	----------	----------	--------------	----	----	----	------	--------

Shutoff Valves

Package Type: Single Pack

LEAD FREE*	LF3561-0604	0959768	1/4" OD x 3/8" Male Comp x 3/8" Female Comp	098268806236	1	5	5	0.16	33.75
-------------------	-------------	---------	---	--------------	---	---	---	------	-------

Package Type: Bulk Pack

LEAD FREE*	LF3561-0604CP	81902858	1/4" OD x 3/8" Male Comp x 3/8" Female Comp	098268806908	50	50	250	0.16	1,387.50
	LF3561-0606CP	81902859	3/8" OD x 3/8" Male Comp x 3/8" Female Comp	098268806915	50	50	250	0.16	1,412.50

Garden Hose Angle Valve

Package Type: Single Pack

LEAD FREE*	3557-1006	0959188	1/2" NPT x 3/4" MGHT	098268322682	1	5	30	0.25	21.75
	3558-1014	0959190	1/2" CTS x 3/4" MGHT	098268322705	1	5	30	0.25	18.50

*The wetted surface of this product contacted by consumable water contains less than 0.25% of lead by weight.

Consult factory for ordering code numbers of special models/options.

Plastic Fittings

Model	Ordering Code	Size & Connection	UPC	Unit Pack Qty.	(Inner Ctn.) Minimum Order Qty.	Master Carton Qty.	Unit Weight (lbs.)	List Price Unit Pack
-------	---------------	-------------------	-----	----------------	---------------------------------	--------------------	--------------------	----------------------

Plastic Fitting Miscellaneous

Collet Clips

Package Type: Three Pack



3547

LEAD FREE	Model	Ordering Code	Size & Connection	UPC	Unit Pack Qty.	(Inner Ctn.) Minimum Order Qty.	Master Carton Qty.	Unit Weight (lbs.)	List Price Unit Pack
	3547-08	0959045	3/8" CTS	098268298758	3	5	60	0.00	\$ 3.50
	3547-10	0959111	1/2" CTS	098268299649	3	5	60	0.00	3.50
	3547-14	0959287	3/4" CTS	098268339062	3	5	60	0.00	3.50
	3547-18	0959268	1" CTS	098268338430	3	5	60	0.06	3.50

Package Type: Bulk Pack

LEAD FREE	Model	Ordering Code	Size & Connection	UPC	Unit Pack Qty.	(Inner Ctn.) Minimum Order Qty.	Master Carton Qty.	Unit Weight (lbs.)	List Price Unit Pack
	3547-08CP	81903004	3/8" CTS	840213003456	100	100	5000	0.00	98.00
	3547-10CP	81903005	1/2" CTS	840213003463	100	100	5000	0.00	98.00
	3547-14CP	81903007	3/4" CTS	840213003470	100	100	2500	0.00	98.00
	3547-18CP	81903008	1" CTS	840213003487	25	25	2500	0.06	24.50

Collet Covers

Package Type: Bulk Pack

LEAD FREE	Model	Ordering Code	Size & Connection	UPC	Unit Pack Qty.	(Inner Ctn.) Minimum Order Qty.	Master Carton Qty.	Unit Weight (lbs.)	List Price Unit Pack
	3555-10CP	81903020	1/2" CTS	840213003500	25	25	300	0.00	14.50
	3555-14CP	81903023	3/4" CTS	840213003517	25	25	300	0.00	14.50
	3555-18CP	81903024	1" CTS	840213003524	25	25	250	0.01	14.50

Cone Seal

Package Type: Bulk Pack



161

LEAD FREE	Model	Ordering Code	Size & Connection	UPC	Unit Pack Qty.	(Inner Ctn.) Minimum Order Qty.	Master Carton Qty.	Unit Weight (lbs.)	List Price Unit Pack
	161-08CP	81902634	For 1/2" NPT to 1/2" NPS	840213002459	100	100	2000	0.00	250.00

PEX Tube Stiffeners

Package Type: Three Pack

LEAD FREE	Model	Ordering Code	Size & Connection	UPC	Unit Pack Qty.	(Inner Ctn.) Minimum Order Qty.	Master Carton Qty.	Unit Weight (lbs.)	List Price Unit Pack
	3560-08	0959479	3/8" CTS	098268089509	3	5	60	0.01	3.75
	3560-10	0959480	1/2" CTS	098268089530	3	5	60	0.01	4.00
	3560-14	0959481	3/4" CTS	098268089547	3	5	60	0.02	4.75
	3560-18	0959482	1" CTS	098268089554	3	5	60	0.02	5.00

Package Type: Bulk Pack

LEAD FREE	Model	Ordering Code	Size & Connection	UPC	Unit Pack Qty.	(Inner Ctn.) Minimum Order Qty.	Master Carton Qty.	Unit Weight (lbs.)	List Price Unit Pack
	3560-08CP	81903032	3/8" CTS	840213003548	100	100	2000	0.00	125.00
	3560-10CP	81903033	1/2" CTS	840213003555	100	100	1000	0.02	150.00
	3560-14CP	81903034	3/4" CTS	840213003562	100	100	1000	0.01	150.00
	3560-18CP	81903035	1" CTS	840213003579	25	25	250	0.01	43.75

*The wetted surface of this product contacted by consumable water contains less than 0.25% of lead by weight.

Consult factory for ordering code numbers of special models/options.

Model	Ordering Code	Size & Connection	UPC	Unit Pack Qty.	(Inner Ctn.) Minimum Order Qty.	Master Carton Qty.	Unit Weight (lbs.)	List Price Unit Pack
-------	---------------	-------------------	-----	----------------	---------------------------------	--------------------	--------------------	----------------------

Plastic Fitting Manifolds - Single

Manifolds - Single Union Body

Package Type: Single Pack

LEAD FREE*	3589-1810	0959257	1" CTS x 1/2" CTS	098268338324	1	5	25	1.00	\$ 42.50
-------------------	-----------	---------	-------------------	--------------	---	---	----	------	----------

Package Type: Bulk Pack

LEAD FREE*	3589-1810CP	81903052	1" CTS x 1/2" CTS	840213003753	20	20	20	1.00	830.00
-------------------	-------------	----------	-------------------	--------------	----	----	----	------	--------

Manifolds - Single Stem Body - Right

Package Type: Single Pack

LEAD FREE*	3590-1810	0959258	1" CTS x 1/2" CTS	098268338331	1	5	15	0.07	36.75
-------------------	-----------	---------	-------------------	--------------	---	---	----	------	-------

Package Type: Bulk Pack

LEAD FREE*	3590-1810CP	81903053	1" CTS x 1/2" CTS	840213003760	20	20	20	0.07	720.00
-------------------	-------------	----------	-------------------	--------------	----	----	----	------	--------

Manifold - Single Stem Body - Left

Package Type: Single Pack

LEAD FREE*	3591-1810	0959259	1" CTS x 1/2" CTS	098268338348	1	5	15	0.26	36.75
-------------------	-----------	---------	-------------------	--------------	---	---	----	------	-------

Package Type: Bulk Pack

LEAD FREE*	3591-1810CP	81903054	1" CTS x 1/2" CTS	840213003777	20	20	20	0.26	720.00
-------------------	-------------	----------	-------------------	--------------	----	----	----	------	--------

Manifold Single Side Mounting Kits

Package Type: Single Pack

LEAD FREE*	3581-18	0959260	For 35 Series Single Manifold	098268338355	1	5	30	0.50	17.00
-------------------	---------	---------	-------------------------------	--------------	---	---	----	------	-------

Package Type: Bulk Pack

LEAD FREE*	3581-18CP	81903044	For 35 Series Single Manifold	840213003609	10	10	100	0.07	165.00
-------------------	-----------	----------	-------------------------------	--------------	----	----	-----	------	--------

Plastic Fitting Manifolds - Dual

Manifolds - Dual Union Body

Package Type: Single Pack

LEAD FREE*	3583-1810	0959303	1" CTS x 1/2" CTS	098268351460	1	5	25	0.40	91.75
-------------------	-----------	---------	-------------------	--------------	---	---	----	------	-------

Package Type: Bulk Pack

LEAD FREE*	3583-1810CP	81903046	1" CTS x 1/2" CTS	840213003633	10	10	10	0.40	757.50
-------------------	-------------	----------	-------------------	--------------	----	----	----	------	--------

Manifolds - Dual Stem Body

Package Type: Single Pack

LEAD FREE*	3584-1810	0959304	1" CTS x 1/2" CTS	098268351477	1	5	25	0.59	78.75
-------------------	-----------	---------	-------------------	--------------	---	---	----	------	-------

Package Type: Bulk Pack

LEAD FREE*	3584-1810CP	81903047	1" CTS x 1/2" CTS	840213003746	10	10	10	0.59	650.00
-------------------	-------------	----------	-------------------	--------------	----	----	----	------	--------

Manifold Dual Side Mounting Kits

Package Type: Single Pack

LEAD FREE*	3580-18	0959295	For 35 Series Dual Manifold	098268346572	1	5	30	0.70	22.50
-------------------	---------	---------	-----------------------------	--------------	---	---	----	------	-------

Package Type: Bulk Pack

LEAD FREE*	3580-18CP	81903043	For 35 Series Dual Manifold	840213003593	10	10	100	0.09	187.50
-------------------	-----------	----------	-----------------------------	--------------	----	----	-----	------	--------

*The wetted surface of this product contacted by consumable water contains less than 0.25% of lead by weight.

Consult factory for ordering code numbers of special models/options.

Plastic Fittings

Model	Ordering Code	Size & Connection	UPC	Unit Pack Qty.	(Inner Ctn.) Minimum Order Qty.	Master Carton Qty.	Unit Weight (lbs.)	List Price Unit Pack
-------	---------------	-------------------	-----	----------------	---------------------------------	--------------------	--------------------	----------------------

Plastic Fitting Manifold Accessories

Manifold Divider Plugs

Package Type: Single Pack

LEAD FREE*	3582-18	0959266	For 35 Series	098268338416	1	5	60	0.18	\$ 7.75
-------------------	---------	---------	---------------	--------------	---	---	----	------	---------

Package Type: Bulk Pack

LEAD FREE*	3582-18CP	81903045	For 35 Series	840213003616	5	5	100	0.02	38.75
-------------------	-----------	----------	---------------	--------------	---	---	-----	------	-------

Manifold Return Ends

Package Type: Single Pack

LEAD FREE*	3585-18	0959296	1" CTS	098268346589	1	5	15	1.00	32.25
-------------------	---------	---------	--------	--------------	---	---	----	------	-------

Package Type: Bulk Pack

LEAD FREE*	3585-18CP	81903048	1" CTS	840213003630	5	5	25	0.14	135.00
-------------------	-----------	----------	--------	--------------	---	---	----	------	--------

Manifold Red Label Plates

Package Type: Single Pack

LEAD FREE*	3586-18	0959261	Red - For 35 and Metric	098268338362	1	5	60	0.20	3.50
-------------------	---------	---------	-------------------------	--------------	---	---	----	------	------

Package Type: Bulk Pack

LEAD FREE*	3586-18CP	81903049	Red - For 35 and Metric	840213003647	10	10	500	0.01	35.00
-------------------	-----------	----------	-------------------------	--------------	----	----	-----	------	-------

Manifold Blue Label Plates

Package Type: Single Pack

LEAD FREE*	3587-18	0959262	Blue - For 35 and Metric	098268338379	1	5	60	0.20	3.50
-------------------	---------	---------	--------------------------	--------------	---	---	----	------	------

Package Type: Bulk Pack

LEAD FREE*	3587-18CP	81903050	Blue - For 35 and Metric	840213003654	10	10	500	0.01	35.00
-------------------	-----------	----------	--------------------------	--------------	----	----	-----	------	-------

Manifold Valve Repair Kits

Package Type: Single Pack

LEAD FREE*	3588-10	0650763	1/2" Spool	098268308812	1	24	120	.07	9.75
-------------------	---------	---------	------------	--------------	---	----	-----	-----	------

Package Type: Bulk Pack

LEAD FREE*	3588-10CP	81903051	1/2" Spool	840213003661	10	10	50	.07	95.00
-------------------	-----------	----------	------------	--------------	----	----	----	-----	-------

Manifold Tool

Package Type: Single Pack

LEAD FREE*	351192-18	0959265	Easy Removal of Outlets	098268338409	1	5	30	1.00	16.25
-------------------	-----------	---------	-------------------------	--------------	---	---	----	------	-------

End Plugs

Package Type: Single Pack

LEAD FREE*	3546-18	0959264	1" CTS	098268338393	1	5	30	0.20	11.50
-------------------	---------	---------	--------	--------------	---	---	----	------	-------

Package Type: Bulk Pack

LEAD FREE*	3546-18CP	81903003	1" CTS	840213003449	5	5	50	0.03	48.75
-------------------	-----------	----------	--------	--------------	---	---	----	------	-------

*The wetted surface of this product contacted by consumable water contains less than 0.25% of lead by weight.

Consult factory for ordering code numbers of special models/options.

Mini Fittings

Model	Ordering Code	Size & Connection	UPC	Unit Pack Qty.	(Inner Ctn.) Minimum Order Qty.	Master Carton Qty.	Unit Weight (lbs.)	List Price Unit Pack
-------	---------------	-------------------	-----	----------------	---------------------------------	--------------------	--------------------	----------------------

Mini Tees

Tees

Package Type: Single Pack



1023

LEAD FREE	1023-04	17103003	1/4" OD	048643197626	1	5	60	0.02	\$ 9.50
	1023-06	17103023	3/8" OD	048643201262	1	5	60	0.04	10.00
	1023-08	17103033	1/2" OD	048643201347	1	5	60	0.07	10.75

Package Type: Bulk Pack

LEAD FREE	1023-04CP	0666115	1/4" OD	098268426502	10	20	200	0.15	78.75
	1023-06CP	0666116	3/8" OD	098268426519	10	10	100	0.30	95.75
	1023-08CP	0666117	1/2" OD	098268426526	10	6	60	0.45	50.25

Reducing Tees

Package Type: Single Pack



1024R

LEAD FREE	1024R-060604	17103034	3/8" OD x 3/8" OD x 1/4" OD	048643236516	1	5	60	0.07	10.00
-----------	--------------	----------	-----------------------------	--------------	---	---	----	------	-------

Package Type: Bulk Pack

LEAD FREE	1024R-060604CP	0666118	3/8" OD x 3/8" OD x 1/4" OD	098268426533	10	10	100	0.30	97.50
	1024R-080806CP	0666119	1/2" OD x 1/2" OD x 3/8" OD	098268426540	10	5	50	0.50	125.00

*The wetted surface of this product contacted by consumable water contains less than 0.25% of lead by weight.

Consult factory for ordering code numbers of special models/options.

Mini Fittings

Model	Ordering Code	Size & Connection	UPC	Unit Pack Qty.	(Inner Ctn.) Minimum Order Qty.	Master Carton Qty.	Unit Weight (lbs.)	List Price Unit Pack
-------	---------------	-------------------	-----	----------------	---------------------------------	--------------------	--------------------	----------------------

Mini Elbows

Elbows

Package Type: Single Pack



1017

LEAD FREE*	Model	Ordering Code	Size & Connection	UPC	Unit Pack Qty.	(Inner Ctn.) Minimum Order Qty.	Master Carton Qty.	Unit Weight (lbs.)	List Price Unit Pack
	1017-04	17103002	1/4" OD	048643197619	1	5	60	0.03	\$ 7.75
	1017-06	17103022	3/8" OD	048643201255	1	5	60	0.05	9.50
	1017-08	17103032	1/2" OD	048643201330	1	5	60	0.05	10.50

Package Type: Bulk Pack

LEAD FREE*	Model	Ordering Code	Size & Connection	UPC	Unit Pack Qty.	(Inner Ctn.) Minimum Order Qty.	Master Carton Qty.	Unit Weight (lbs.)	List Price Unit Pack
	1017-04CP	0666120	1/4" OD	098268426557	10	30	300	0.10	75.00
	1017-06CP	0666121	3/8" OD	098268426564	10	10	100	0.20	90.75
	1017-08CP	0666122	1/2" OD	098268426571	10	10	100	0.30	101.00



1017R

Reducing Elbows

Package Type: Single Pack

LEAD FREE*	Model	Ordering Code	Size & Connection	UPC	Unit Pack Qty.	(Inner Ctn.) Minimum Order Qty.	Master Carton Qty.	Unit Weight (lbs.)	List Price Unit Pack
	1017R-0604	0666146	3/8" OD x 1/4" OD	098268426816	10	20	200	0.10	50.75



1018

Stackable Elbows

Package Type: Bulk Pack

LEAD FREE*	Model	Ordering Code	Size & Connection	UPC	Unit Pack Qty.	(Inner Ctn.) Minimum Order Qty.	Master Carton Qty.	Unit Weight (lbs.)	List Price Unit Pack
	1018-04CP	0666142	1/4" OD	098268426779	10	25	250	0.15	37.00
	1018-06CP	0666143	3/8" OD	098268426786	10	10	100	0.25	45.50
	1018-08CP	0666144	1/2" OD	098268426793	8	8	80	0.40	56.00

Male Elbows

Package Type: Single Pack



1019

LEAD FREE*	Model	Ordering Code	Size & Connection	UPC	Unit Pack Qty.	(Inner Ctn.) Minimum Order Qty.	Master Carton Qty.	Unit Weight (lbs.)	List Price Unit Pack
	1019-0402	17103008	1/4" OD x 1/8" MNPT	048643201217	1	5	60	0.03	7.25
	1019-0404	17103009	1/4" OD x 1/4" MNPT	048643201224	1	5	60	0.02	7.25
	1019-0406	17103028	3/8" OD x 1/4" MNPT	048643201316	1	5	60	0.04	7.75
	1019-0606	17103029	3/8" OD x 3/8" MNPT	048643201323	1	5	60	0.04	7.25
	1019-0806	17103038	1/2" OD x 3/8" MNPT	048643201378	1	5	60	0.05	8.75
	1019-0808	17103039	1/2" OD x 1/2" MNPT	048643201385	1	5	60	0.06	9.50

Package Type: Bulk Pack

LEAD FREE*	Model	Ordering Code	Size & Connection	UPC	Unit Pack Qty.	(Inner Ctn.) Minimum Order Qty.	Master Carton Qty.	Unit Weight (lbs.)	List Price Unit Pack
	1019-0402CP	0666135	1/4" OD x 1/8" MNPT	098268426700	10	30	300	0.10	69.00
	1019-0404CP	0666136	1/4" OD x 1/4" MNPT	098268426717	10	30	300	0.05	69.00
	1019-0406CP	0666137	1/4" OD x 3/8" MNPT	098268426724	10	20	200	0.20	77.00
	1019-0604CP	0666138	3/8" OD x 1/4" MNPT	098268426731	10	10	100	0.15	180.50
	1019-0606CP	0666139	3/8" OD x 3/8" MNPT	098268426748	10	20	200	0.15	69.00
	1019-0806CP	0666140	1/2" OD x 3/8" MNPT	098268426755	10	10	100	0.25	85.00
	1019-0808CP	0666141	1/2" OD x 1/2" MNPT	098268426762	10	10	100	0.15	87.50

*The wetted surface of this product contacted by consumable water contains less than 0.25% of lead by weight.

Consult factory for ordering code numbers of special models/options.

Mini Fittings

Model	Ordering Code	Size & Connection	UPC	Unit Pack Qty.	(Inner Ctn.) Minimum Order Qty.	Master Carton Qty.	Unit Weight (lbs.)	List Price Unit Pack
-------	---------------	-------------------	-----	----------------	---------------------------------	--------------------	--------------------	----------------------

Mini Connectors

Couplings

Package Type: Single Pack



1015

LEAD FREE*	Model	Ordering Code	Size & Connection	UPC	Unit Pack Qty.	(Inner Ctn.) Minimum Order Qty.	Master Carton Qty.	Unit Weight (lbs.)	List Price Unit Pack
	1015-04	17103000	1/4" OD	048643197596	1	5	60	0.02	\$ 7.25
	1015-05	17103015	5/16" OD	098268784831	1	5	60	0.04	18.75
	1015-06	17103020	3/8" OD	048643197633	1	5	60	0.03	9.50
	1015-08	17103030	1/2" OD	048643197657	1	5	60	0.05	9.75

Package Type: Bulk Pack

LEAD FREE*	Model	Ordering Code	Size & Connection	UPC	Unit Pack Qty.	(Inner Ctn.) Minimum Order Qty.	Master Carton Qty.	Unit Weight (lbs.)	List Price Unit Pack
	1015-04CP	0666110	1/4" OD	098268426458	10	30	300	0.10	59.00
	1015-06CP	0666111	3/8" OD	098268426465	10	10	100	0.20	84.50
	1015-08CP	0666112	1/2" OD	098268426472	10	10	100	0.30	71.00

Reducing Couplings

Package Type: Single Pack

LEAD FREE*	Model	Ordering Code	Size & Connection	UPC	Unit Pack Qty.	(Inner Ctn.) Minimum Order Qty.	Master Carton Qty.	Unit Weight (lbs.)	List Price Unit Pack
	1015R-0504	17103016	5/16" OD x 1/4" OD	098268784848	1	5	60	0.04	18.75
	1015R-0604	17103021	3/8" OD x 1/4" OD	048643197640	1	5	60	0.04	8.75
	1015R-0806	17103031	1/2" OD x 3/8" OD	048643197664	1	5	60	0.03	10.00

Package Type: Bulk Pack

LEAD FREE*	Model	Ordering Code	Size & Connection	UPC	Unit Pack Qty.	(Inner Ctn.) Minimum Order Qty.	Master Carton Qty.	Unit Weight (lbs.)	List Price Unit Pack
	1015R-0604CP	0666113	3/8" OD x 1/4" OD	098268426489	10	20	200	0.15	170.00
	1015R-0806CP	0666114	1/2" OD x 3/8" OD	098268426496	10	8	80	0.35	955.00

Male Adapters

Package Type: Single Pack



1001

LEAD FREE*	Model	Ordering Code	Size & Connection	UPC	Unit Pack Qty.	(Inner Ctn.) Minimum Order Qty.	Master Carton Qty.	Unit Weight (lbs.)	List Price Unit Pack
	1001-0402	17103004	1/4" OD x 1/8" MNPT	048643201170	1	5	60	0.03	7.25
	1001-0404	17103005	1/4" OD x 1/4" MNPT	048643201187	1	5	60	0.02	7.25
	1001-0406	17103006	1/4" OD x 3/8" MNPT	048643201194	1	5	60	0.04	7.25
	1001-0408	17103007	1/4" OD x 1/2" MNPT	048643201200	1	5	60	0.05	7.75
	1001-0602	17103024	3/8" OD x 1/8" MNPT	048643201279	1	5	60	0.04	7.75
	1001-0604	17103025	3/8" OD x 1/4" MNPT	048643201286	1	5	60	0.04	7.75
	1001-0606	17103026	3/8" OD x 3/8" MNPT	048643201293	1	5	60	0.20	7.75
	1001-0608	17103027	3/8" OD x 1/2" MNPT	048643201309	1	5	60	0.05	8.75
	1001-0806	17103035	1/2" OD x 3/8" MNPT	048643201354	1	5	60	0.05	8.75
	1001-0808	17103036	1/2" OD x 1/2" MNPT	048643201361	1	5	60	0.05	9.50

Package Type: Bulk Pack

LEAD FREE*	Model	Ordering Code	Size & Connection	UPC	Unit Pack Qty.	(Inner Ctn.) Minimum Order Qty.	Master Carton Qty.	Unit Weight (lbs.)	List Price Unit Pack
	1001-0402CP	0666125	1/4" OD x 1/8" MNPT	098268426601	10	30	300	0.05	69.00
	1001-0404CP	0666126	1/4" OD x 1/4" MNPT	098268426618	10	30	300	0.10	69.00
	1001-0406CP	0666127	1/4" OD x 3/8" MNPT	098268426625	10	30	300	0.10	69.00
	1001-0408CP	0666128	1/4" OD x 1/2" MNPT	098268426632	10	25	250	0.15	77.00
	1001-0602CP	0666129	3/8" OD x 1/8" MNPT	098268426649	10	25	250	0.15	77.00
	1001-0604CP	0666130	3/8" OD x 1/4" MNPT	098268426656	10	20	200	0.15	77.00
	1001-0606CP	0666131	3/8" OD x 3/8" MNPT	098268426663	10	20	200	0.15	77.00
	1001-0608CP	0666132	3/8" OD x 1/2" MNPT	098268426670	10	20	200	0.15	54.25
	1001-0806CP	0666133	1/2" OD x 3/8" MNPT	098268426687	10	15	150	0.20	54.75
	1001-0808CP	0666134	1/2" OD x 1/2" MNPT	098268426694	10	15	150	0.15	54.75

*The wetted surface of this product contacted by consumable water contains less than 0.25% of lead by weight.

Consult factory for ordering code numbers of special models/options.

Mini Fittings

Model	Ordering Code	Size & Connection	UPC	Unit Pack Qty.	(Inner Ctn.) Minimum Order Qty.	Master Carton Qty.	Unit Weight (lbs.)	List Price Unit Pack
-------	---------------	-------------------	-----	----------------	---------------------------------	--------------------	--------------------	----------------------

Mini Connectors (continued)

Female Adapters

Package Type: Single Pack



1010

LEAD FREE*	1010-0404	17103060	1/4" OD x 1/4" FNPT	048643236165	1	5	60	0.04	\$ 8.25
	1010-0604	17103065	3/8" OD x 1/4" FNPT	048643236172	1	5	60	0.04	9.75

Package Type: Bulk Pack

LEAD FREE*	1010-0401CP	0666147	1/4" OD x 7/16" UNS	098268426823	10	20	200	0.20	175.00
	1010-0601CP	0666148	3/8" OD x 7/16" UNS	098268426830	10	20	200	0.18	175.00
	1010-0404CP	0666123	1/4" OD x 1/4" FNPT	098268426588	10	20	200	0.15	82.50
	1010-0604CP	0666124	3/8" OD x 1/4" FNPT	098268426595	10	20	200	0.15	93.00

Mini Stems

Male Stems

Package Type: Bulk Pack



1027

LEAD FREE*	1027-0402CP	0666104	1/4" OD x 1/8" MNPT	098268426397	10	30	300	0.10	25.25
	1027-0604CP	0666106	3/8" OD x 1/4" MNPT	098268426410	10	10	100	0.20	26.00
	1027-0606CP	0666107	3/8" OD x 3/8" MNPT	098268426427	10	10	100	0.20	25.50
	1027-0806CP	0666108	1/2" OD x 3/8" MNPT	098268426434	10	10	100	0.20	28.50

Reducing Stems

Package Type: Bulk Pack



1014R

LEAD FREE*	1014R-0604CP	0666145	3/8" OD x 1/4" OD	098268426809	10	30	300	0.05	30.50
-------------------	--------------	---------	-------------------	--------------	----	----	-----	------	-------

Mini Caps

End Caps

Package Type: Single Pack



1045

LEAD FREE*	1045-04	17103047	1/4" OD	098268534573	1	5	60	0.05	6.25
-------------------	---------	----------	---------	--------------	---	---	----	------	------

Package Type: Bulk Pack

LEAD FREE*	1045-04CP	0666109	1/4" OD	098268426441	10	50	500	0.05	4,135.00
-------------------	-----------	---------	---------	--------------	----	----	-----	------	----------

*The wetted surface of this product contacted by consumable water contains less than 0.25% of lead by weight.

Consult factory for ordering code numbers of special models/options.

Mini Fittings

Model	Ordering Code	Size & Connection	UPC	Unit Pack Qty.	(Inner Ctn.) Minimum Order Qty.	Master Carton Qty.	Unit Weight (lbs.)	List Price Unit Pack
-------	---------------	-------------------	-----	----------------	---------------------------------	--------------------	--------------------	----------------------

Mini Valves

Straight Valves

Package Type: **Single Pack**



1039

LEAD FREE*	1039-04	17103011	1/4" OD	048643201231	1	5	60	0.05	\$ 18.75
	1039-06	17103041	3/8" OD	048643197688	1	5	60	0.06	19.75

Package Type: **Bulk Pack**

LEAD FREE*	1039-04CP	0666102	1/4" OD	098268426373	10	8	80	0.45	161.00
	1039-06CP	0666103	3/8" OD	098268426380	10	6	60	0.55	191.50



1062

Male Straight Valves

Package Type: **Single Pack**

LEAD FREE*	1062-04	17103012	1/4" OD x 1/4" NPT	048643201248	1	5	60	0.05	19.75
	1062-06	17103042	3/8" OD x 3/8" NPT	048643201392	1	5	60	0.06	20.50

Package Type: **Bulk Pack**

LEAD FREE*	1062-04CP	0666100	1/4" OD x 1/4" NPT	098268426359	10	8	80	0.45	152.00
	1062-06CP	0666101	3/8" OD x 3/8" NPT	098268426366	10	6	60	0.55	166.50



1053

Female Angle Valves

Package Type: **Bulk Pack**

LEAD FREE*	1053-0404CP	0666149	1/4" OD x 1/4" NPT	098268426847	10	8	80	0.45	156.50
	1053-0604CP	0666150	3/8" OD x 1/4" NPT	098268427134	10	6	60	0.50	241.50

*The wetted surface of this product contacted by consumable water contains less than 0.25% of lead by weight.
Consult factory for ordering code numbers of special models/options.

Metric Fittings

Model	Ordering Code	Size & Connection	UPC	Unit Pack Qty.	(Inner Ctn.) Minimum Order Qty.	Master Carton Qty.	Unit Weight (lbs.)	List Price Unit Pack
-------	---------------	-------------------	-----	----------------	---------------------------------	--------------------	--------------------	----------------------

Metric Tees

Tees

Package Type: Single Pack

LEAD FREE*	1123-1515	81902169	15MM	840213133573	1	5	50	0.09375	\$ 12.50
------------	-----------	----------	------	--------------	---	---	----	---------	----------

Package Type: Bulk Pack

LEAD FREE*	1123-1515CP	81902439	15MM	840213002329	10	10	80	0.09375	122.50
	1123-1515-5CP	81902440	15MM	840213003838	10	10	80	0.09375	130.00
	1623-2222CP	81902644	22MM	840213002503	5	5	40	0.14375	122.50

Reducing Tees

Package Type: Bulk Pack

LEAD FREE*	1624-221515CP	81902648	22MM x 15MM x 15MM	840213002510	5	5	60	0.125	128.75
	1624-222215CP	81902650	22MM x 22MM x 15MM	840213002527	5	5	50	0.125	128.75

Stackable Tees

Package Type: Single Pack

LEAD FREE*	1133-1515	81902172	15MM	840213133603	1	5	50	0.0625	12.50
------------	-----------	----------	------	--------------	---	---	----	--------	-------

Package Type: Bulk Pack

LEAD FREE*	1133-1515CP	81902447	15MM	840213002343	10	10	100	0.0625	122.50
	1133-2222CP	81902449	22MM	840213002350	5	5	40	0.125	96.25

*The wetted surface of this product contacted by consumable water contains less than 0.25% of lead by weight.
Consult factory for ordering code numbers of special models/options.

Metric Fittings

Model	Ordering Code	Size & Connection	UPC	Unit Pack Qty.	(Inner Ctn.) Minimum Order Qty.	Master Carton Qty.	Unit Weight (lbs.)	List Price Unit Pack
-------	---------------	-------------------	-----	----------------	---------------------------------	--------------------	--------------------	----------------------

Metric Elbows

Elbows

Package Type: Single Pack

LEAD FREE*	1117-1515	81902163	15MM	840213133511	1	5	50	0.0625	\$ 9.50
-------------------	-----------	----------	------	--------------	---	---	----	--------	---------

Package Type: Bulk Pack

LEAD FREE*	1117-1515CP	81902424	15MM	840213002268	10	10	100	0.0625	87.50
	1617-2222CP	81902640	22MM	840213002480	5	5	50	0.0625	87.50

Stackable Elbows

Package Type: Single Pack

LEAD FREE*	1118-1515	81902164	15MM	840213133528	1	5	50	0.05	10.50
-------------------	-----------	----------	------	--------------	---	---	----	------	-------

Package Type: Bulk Pack

LEAD FREE*	1118-1515CP	81902426	15MM	840213002275	10	10	100	0.05	102.50
	1618-2222CP	81902642	22MM	840213002497	5	5	80	0.075	108.75

Male Elbows

Package Type: Bulk Pack

LEAD FREE*	1119-0815CP	81902428	15MM x 1/2" NPT	840213002282	10	10	100	0.05	125.00
-------------------	-------------	----------	-----------------	--------------	----	----	-----	------	--------

Female Swivel Elbows

Package Type: Single Pack

LEAD FREE*	1120-0815	81902166	15MM x 1/2" NPS	840213133542	1	5	50	0.0625	12.50
-------------------	-----------	----------	-----------------	--------------	---	---	----	--------	-------

Package Type: Bulk Pack

LEAD FREE*	1120-0815CP	81902431	15MM x 1/2" NPS	840213002299	10	10	100	0.0625	122.50
	1120-1215CP	81902433	15MM x 3/4" NPS	840213002305	10	10	100	0.06875	200.00

Drop Ear Elbows

Package Type: Bulk Pack

LEAD FREE*	1121-0815CP	81902437	15MM x 1/2" NPS	840213133542	1	5	50	0.0625	137.50
-------------------	-------------	----------	-----------------	--------------	---	---	----	--------	--------

Elbow Pump Adapter

Package Type: Bulk Pack

LEAD FREE*	2476-15CP	81902812	15MM	840213002626	10	10	100	0.05625	95.00
-------------------	-----------	----------	------	--------------	----	----	-----	---------	-------

*The wetted surface of this product contacted by consumable water contains less than 0.25% of lead by weight.
Consult factory for ordering code numbers of special models/options.

Metric Fittings

Model	Ordering Code	Size & Connection	UPC	Unit Pack Qty.	(Inner Ctn.) Minimum Order Qty.	Master Carton Qty.	Unit Weight (lbs.)	List Price Unit Pack
-------	---------------	-------------------	-----	----------------	---------------------------------	--------------------	--------------------	----------------------

Metric Connectors

Couplings

Package Type: Single Pack

LEAD FREE	1115-1515	81902161	15MM	840213133498	1	5	50	0.0625	\$ 8.75
-----------	-----------	----------	------	--------------	---	---	----	--------	---------

Package Type: Bulk Pack

LEAD FREE	1115-1515CP	81902418	15MM	840213002244	10	10	100	0.0625	85.00
	1615-2222CP	81902638	22MM	840213002473	5	5	60	0.08125	80.00

Reducing Couplings

Package Type: Single Pack

LEAD FREE	1116-1015	81902162	1/2" CTS x 15MM	840213133504	1	5	50	0.0625	10.50
-----------	-----------	----------	-----------------	--------------	---	---	----	--------	-------

Package Type: Bulk Pack

LEAD FREE	1116-1015CP	81902422	1/2" CTS x 15MM	840213002251	10	10	100	0.04375	102.50
-----------	-------------	----------	-----------------	--------------	----	----	-----	---------	--------

Male Adapters (Brass)

Package Type: Bulk Pack

LEAD FREE	1201-0815CP	81907005	15MM x 1/2" NPT	098268819816	10	10	10	0.213	295.00
	1701-1222CP	81907012	22MM x 3/4" NPT	098268819922	10	10	10	0.33	545.00

Male Adapters

Package Type: Single Pack

LEAD FREE	2402-0815	81902195	15MM x 1/2" NPT	840213133801	1	5	50	0.0375	8.75
-----------	-----------	----------	-----------------	--------------	---	---	----	--------	------

Package Type: Bulk Pack

LEAD FREE	2402-0815CP	81902767	15MM x 1/2" NPT	840213002565	10	10	100	0.0375	85.00
	2902-1222CP	81902834	22MM x 3/4" NPT	840213002640	5	5	100	0.0875	93.75

Female Swivel Adapters

Package Type: Single Pack

LEAD FREE	1110-0815	81902158	15MM x 1/2" NPS	840213133467	1	5	50	0.05	10.25
-----------	-----------	----------	-----------------	--------------	---	---	----	------	-------

Package Type: Bulk Pack

LEAD FREE	1110-0815CP	81902402	15MM x 1/2" NPS	840213002206	10	10	100	0.05	100.00
	1110-1215CP	81902404	15MM x 3/4" NPS	840213002213	10	10	100	0.06875	160.00
	2609-1215CP	81902827	15MM x 3/4" FGHT	840213002633	5	5	100	0.05	79.50
	1607-1222CP	81902632	22MM x 3/4" NPS	840213002442	5	5	100	0.0625	79.50

Hose Barb Adapters

Package Type: Single Pack

LEAD FREE	2413-0815	81902200	15MM	840213133856	1	5	50	0.04	13.75
-----------	-----------	----------	------	--------------	---	---	----	------	-------

Package Type: Bulk Pack

LEAD FREE	1413-0615CP	81902602	15MM x 3/8" HB	840213003739	10	10	100	0.0625	132.50
	2413-0815CP	81902778	15MM x 1/2" HB	840213002572	10	10	100	0.0375	132.50
	2913-1222CP	81902839	22MM x 3/4" HB	840213002657	10	10	100	0.0625	147.50

*The wetted surface of this product contacted by consumable water contains less than 0.25% of lead by weight.

Consult factory for ordering code numbers of special models/options.

Metric Fittings

Model	Ordering Code	Size & Connection	UPC	Unit Pack Qty.	(Inner Ctn.) Minimum Order Qty.	Master Carton Qty.	Unit Weight (lbs.)	List Price Unit Pack
-------	---------------	-------------------	-----	----------------	---------------------------------	--------------------	--------------------	----------------------

Metric Connectors (continued)

Pump Adapters

Package Type: Bulk Pack

LEAD FREE*	2475-15CP	81902811	15MM	840213002619	10	10	100	0.0375	\$95.00
-------------------	-----------	----------	------	--------------	----	----	-----	--------	---------

Compression Adapters (Brass)

Package Type: Single Pack

LEAD FREE*	1212-0615CP	81907007	15MM x 3/8" CMP	098268819854	1	1	100	.23	35.00
-------------------	-------------	----------	-----------------	--------------	---	---	-----	-----	-------

Metric Stems

Male Stems (Brass)

Package Type: Bulk Pack

LEAD FREE*	1229-0615CP	81907008	15MM x 1/2" NPT	098268819861	10	10	10	0.15	280.00
-------------------	-------------	----------	-----------------	--------------	----	----	----	------	--------

Reducing Stem

Package Type: Bulk Pack

LEAD FREE*	1614-1522CP	81902636	22MM	840213002466	5	5	100	0.04375	63.75
-------------------	-------------	----------	------	--------------	---	---	-----	---------	-------

Metric Caps

End Caps

Package Type: Single Pack

LEAD FREE*	1145-15	81902173	15MM	840213133610	1	5	50	0.03125	9.75
-------------------	---------	----------	------	--------------	---	---	----	---------	------

Package Type: Bulk Pack

LEAD FREE*	1145-15CP	81902452	15MM	840213002374	10	10	200	0.03125	95.00
LEAD FREE*	1645-22CP	81902652	22MM	840213002534	5	5	50	0.05	56.50

End Plugs

Package Type: Bulk Pack

LEAD FREE*	1146-15CP	81902455	15MM	840213002381	10	10	100	0.01875	60.00
LEAD FREE*	1146-18CP	81902456	15MM	840213006570	10	5	30	0.3	95.00

*The wetted surface of this product contacted by consumable water contains less than 0.25% of lead by weight.
Consult factory for ordering code numbers of special models/options.

Metric Fittings

Model	Ordering Code	Size & Connection	UPC	Unit Pack Qty.	(Inner Ctn.) Minimum Order Qty.	Master Carton Qty.	Unit Weight (lbs.)	List Price Unit Pack
-------	---------------	-------------------	-----	----------------	---------------------------------	--------------------	--------------------	----------------------

Metric Valves

Straight Valves

Package Type: Single Pack

LEAD FREE	2439-1515	81902216	15MM	840213134006	1	5	50	0.13125	\$ 34.25
------------------	-----------	----------	------	--------------	---	---	----	---------	----------

Package Type: Bulk Pack

LEAD FREE	2439-1515CP	81902801	15MM	840213002589	10	10	80	0.13125	335.00
	2939-2222CP	81902841	22MM	840213002664	5	5	40	0.4375	348.75

Stackable Valves

Package Type: Bulk Pack

LEAD FREE	2443-0415CP	81902807	15MM x 1/4" OD	840213002602	10	10	80	0.1125	312.50
	2440-1515CP	81902803	15MM x 15MM	840213002596	10	10	80	0.1125	287.50

Tee Valves

Package Type: Bulk Pack

LEAD FREE	2444-0415-5CP	81902809	15MM x 1/4" OD	840213137311	5	5	50	.15	222.50
------------------	---------------	----------	----------------	--------------	---	---	----	-----	--------

Check Valves

Package Type: Bulk Pack

LEAD FREE	1140-15CP	81902451	15MM	840213002367	10	10	80	0.0625	170.00
------------------	-----------	----------	------	--------------	----	----	----	--------	--------

Male Stem Check Valves (Brass)

Package Type: Bulk Pack

LEAD FREE	1235-0815CP	81907010	15MM x 1/2" NPT	098268819892	10	10	10	0.15	335.00
------------------	-------------	----------	-----------------	--------------	----	----	----	------	--------

Stem Check Valves (Brass)

Package Type: Bulk Pack

LEAD FREE	1237-15CP	81907011	15MM	098268819915	10	10	10	0.15	402.50
------------------	-----------	----------	------	--------------	----	----	----	------	--------

*The wetted surface of this product contacted by consumable water contains less than 0.25% of lead by weight.
Consult factory for ordering code numbers of special models/options.

Model	Ordering Code	Size & Connection	UPC	Unit Pack Qty.	(Inner Ctn.) Minimum Order Qty.	Master Carton Qty.	Unit Weight (lbs.)	List Price Unit Pack
-------	---------------	-------------------	-----	----------------	---------------------------------	--------------------	--------------------	----------------------

Metric Miscellaneous

Collet Clip

Package Type: Single Pack

LEAD FREE*	1147-15	81902174	15MM	840213133627	3	5	50	0.00375	\$ 3.50
------------	---------	----------	------	--------------	---	---	----	---------	---------

Package Type: Bulk Pack

LEAD FREE*	1147-15CP	81902457	15MM	840213002398	100	100	5000	0.00125	350.00
	1147-22CP	81902458	22MM	840213002404	100	100	500	0.0025	95.00

Collet Cover

Package Type: Bulk Pack

LEAD FREE*	2154-15CP	81902702	15MM	840213002541	25	25	300	0.002625	14.50
	2156-15CP	81902704	15MM	840213002558	25	25	300	0.002625	14.50
	2957-22CP	81902848	22MM	840213006280	25	25	300	0.003875	14.50

Elbow Clip

Package Type: Bulk Pack

LEAD FREE*	2349-15CP	81902747	15MM	840213136895	10	10	300	.003	52.50
	2349-22CP	81902748	22MM	840213136901	5	5	150	.003	57.50

Metric Manifolds - Single

Manifolds - Single Union Body

Package Type: Single Pack

LEAD FREE*	1189-1815	81902479	15MM	840213003708	1	5	20	0.21	\$41.75
------------	-----------	----------	------	--------------	---	---	----	------	---------

Manifolds - Single Stem Body - Right

Package Type: Single Pack

LEAD FREE*	1190-1815	81902481	15MM	840213003715	1	5	20	0.19	36.25
------------	-----------	----------	------	--------------	---	---	----	------	-------

Manifold - Single Stem Body - Left

Package Type: Single Pack

LEAD FREE*	1190-1815	81902481	15MM	840213003715	1	5	20	0.19	36.25
------------	-----------	----------	------	--------------	---	---	----	------	-------

Manifold Single Side Mounting Kits

Package Type: Single Pack

LEAD FREE*	1181-18	81902473	For Metric Series Dual Manifold	098268338355	1	1	50	0.07	16.50
------------	---------	----------	---------------------------------	--------------	---	---	----	------	-------

*The wetted surface of this product contacted by consumable water contains less than 0.25% of lead by weight.
Consult factory for ordering code numbers of special models/options.

Metric Fittings

Model	Ordering Code	Size & Connection	UPC	Unit Pack Qty.	(Inner Ctn.) Minimum Order Qty.	Master Carton Qty.	Unit Weight (lbs.)	List Price Unit Pack
-------	---------------	-------------------	-----	----------------	---------------------------------	--------------------	--------------------	----------------------

Metric Manifolds - Dual

Manifolds - Dual Union Body

Package Type: Single Pack

LEAD FREE*	1183-1815	81902475	15MM	840213003685	1	1	10	0.41	\$77.25
-------------------	-----------	----------	------	--------------	---	---	----	------	---------

Manifolds - Dual Stem Body

Package Type: Single Pack

LEAD FREE*	1184-1815	81902476	15MM	840213003692	1	1	10	0.37	65.50
-------------------	-----------	----------	------	--------------	---	---	----	------	-------

Manifold Dual Side Mounting Kits

Package Type: Single Pack

LEAD FREE*	1180-18	81902472	For Metric Series Dual Manifold	840213002411	1	1	50	0.09	18.75
-------------------	---------	----------	---------------------------------	--------------	---	---	----	------	-------

Metric Manifold Accessories

Manifold Return Ends

Package Type: Single Pack

LEAD FREE*	1185-18	81902477	1" CTS	098268346589	1	5	15	1.00	\$27.25
-------------------	---------	----------	--------	--------------	---	---	----	------	---------

Manifold Red Label Plates

Package Type: Single Pack

LEAD FREE*	3586-18	0959261	Red - For 35 and Metric	098268338362	1	5	60	0.20	3.50
-------------------	---------	---------	-------------------------	--------------	---	---	----	------	------

Package Type: Bulk Pack

LEAD FREE*	3586-18CP	81903049	Red - For 35 and Metric	840213003647	10	10	500	0.01	35.00
-------------------	-----------	----------	-------------------------	--------------	----	----	-----	------	-------

Manifold Blue Label Plates

Package Type: Single Pack

LEAD FREE*	3587-18	0959262	Blue - For 35 and Metric	098268338379	1	5	60	0.20	3.50
-------------------	---------	---------	--------------------------	--------------	---	---	----	------	------

Package Type: Bulk Pack

LEAD FREE*	3587-18CP	81903050	Blue - For 35 and Metric	840213003654	10	10	500	0.01	35.00
-------------------	-----------	----------	--------------------------	--------------	----	----	-----	------	-------

Manifold Valve Repair Kits

Package Type: Bulk Pack

LEAD FREE*	1188-15CP	81902478	15MM	118811	10	10	50	0.04	87.50
-------------------	-----------	----------	------	--------	----	----	----	------	-------

*The wetted surface of this product contacted by consumable water contains less than 0.25% of lead by weight.

Consult factory for ordering code numbers of special models/options.

To locate your nearest Watts representative, please click on our *find a sales rep* locator on watts.com.

Represented by:

