

For Residential, Commercial and Institutional Applications

Job Name _____

Contractor _____

Job Location _____

Approval _____

Engineer _____

Contractor's P.O. No. _____

Approval _____

Representative _____

LEAD FREE*

Series LFMMV Thermostatic Mixing Valves

Sizes: 1/2" – 1" (15 – 25mm)

Series LFMMV Thermostatic Mixing Valves maintain and limit mixed hot water to a desired, selectable temperature. The LFMMV series can be set to any temperature between 80°F and 120°F with flow rates as low as 0.5 gpm and as high as 12 gpm (refer to capacity chart on back). This mixing valve series is listed under ASSE 1017 for valves used in hot water source applications, ASSE 1069 for single-pipe, tempered water applications and ASSE 1070 for valves used in individual or multiple fixture applications and also listed IAPMO cUPC. The LFMMVs feature Lead Free* construction to comply with Lead Free* installation requirements.

The LFMMV-M1 uses a double throttling design to control both the hot and cold water supply to the mixed outlet. The superior flow characteristics of this valve provide accurate temperature control ($\pm 3^\circ\text{F}$) with low pressure drop across the rated flow range. As an added feature, the LFMMV-M1 series incorporates integral inlet filter washers and check valves in both the hot and cold water inlets to protect against cross flow.

The LFMMV-M1 is available with either union thread (-UT), union solder (-US), CPVC (-CPVC) Quick-Connect (-QC) or PEX (-PEX) end connectors or w/press.

Features

- Lead Free* cast copper silicon alloy body construction
- Solid wax hydraulic principle thermostat assures dependable mixing of hot and cold water
- Thermostat controls both hot and cold water
- Solder, threaded, PEX or CPVC, Quick-Connect end connection or w/press
- Adjustment cap with locking feature
- ASSE 1017 listed
- ASSE 1069 listed
- ASSE 1070 listed
- IAPMO cUPC listed
- Integral filter washers and check valves

Specifications

A Thermostatic Mixing Valve shall be installed on the hot water supply to fixture. The valve shall be ASSE 1017, ASSE 1069, ASSE 1070 and IAPMO cUPC listed. It shall have a Lead Free* cast copper silicon alloy body. Lead Free* thermostatic valves shall comply with state codes and standards, where applicable, requiring reduced lead content. The valve shall include integral filter washers and check valves and an adjustment cap with locking feature. The valve shall be provided with solder (-US), threaded (-UT), CPVC, (-CPVC) Quick Connect (-QC) or PEX (-PEX) or w/press union connections. The valve shall be a Watts Series LFMMV-M1.

Triple Listed!
ASSE 1017,
ASSE 1069 & ASSE 1070



⚠ WARNING

When used in an ASSE 1017 application at the hot water source, the Watts Thermostatic Mixing Valve Series LFMMV cannot be used by itself to control final temperature at fixtures where ASSE Standard 1016 or ASSE Standard 1070 listed devices are required. Such use may result in severe bodily injury (i.e. scalding or chilling) and/or death. ASSE Standard 1016, ASSE 1069 or ASSE Standard 1070 listed devices, such as Watts Series LFUSG, LFL111 or LFMMV, should be used at point-of-use to prevent possible injury. Consult all product manuals, and instruction guides before installing any referenced product.

Recirculation systems should recirculate water at temperatures over 140°F to reduce the risk of bacterial growth in the piping. This valve should not be used at the hot water source in recirculation systems.

⚠ WARNING

Water temperatures in excess 110°F (43°C) are dangerous and may cause scalding, severe injury or death! This valve can be adjusted to deliver water at temperatures exceeding 110°F (43°C). Consequently, when used in an ASSE 1016, ASSE 1069 or ASSE 1070 application, the installer must check the mixed water outlet temperature at the point of use and adjust the Watts Thermostatic Mixing Valve Series LFMMV to ensure delivery of water at a safe temperature not exceeding 110°F (43°C). Mechanical valves are not fail-safe. Due to the effects of various water conditions, periodic verification of outlet water temperature is required.

NOTICE

The information contained herein is not intended to replace the full product installation and safety information available or the experience of a trained product installer. You are required to thoroughly read all installation instructions and product safety information before beginning the installation of this product.

*The wetted surface of this product contacted by consumable water contains less than 0.25% of lead by weight.

Watts product specifications in U.S. customary units and metric are approximate and are provided for reference only. For precise measurements, please contact Watts Technical Service. Watts reserves the right to change or modify product design, construction, specifications, or materials without prior notice and without incurring any obligation to make such changes and modifications on Watts products previously or subsequently sold.

Applications

The LFMMV-M1 Thermostatic Mixing Valves are ideal for supplying sinks, baths, showers or lavatories with tempered water. The LFMMV-M1 valves can be used in residential, commercial and institutional environments. These thermostatically modulated mixing valves can be used anywhere preset water temperature is required for point-of-use installations such as in homes, schools, restaurants, hospitals, beauty salons, and public restrooms. The LFMMV-M1 is provided with an adjustment cap that includes a locking feature.

The LFMMV-M1 valves should be used prior to the fixture to reduce the hot water supply to a safe temperature.

Materials

Body:	Lead Free* cast copper silicon alloy
Disc:	Stainless steel
Thermostat Assembly:	Copper
O-rings:	Buna-N; EPDM
Pistons:	Polysulfone (PSU)
Springs:	Stainless Steel

Basic Construction

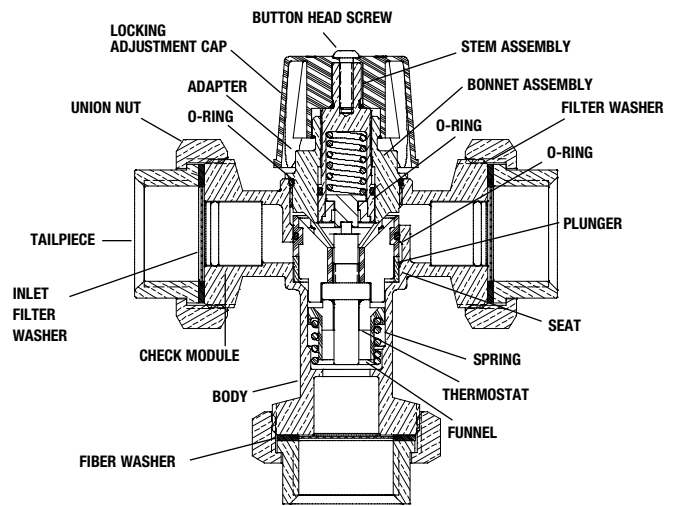

Pressure — Temperature — Flow Rate

Minimum Supply Pressure Static: 30psi (207 kPa)

Inlet Temperatures: hot inlet, 120°F – 180°F (49°C – 82°C),
cold inlet, 39°F – 85°F (4°C – 29°C)

Hot Water Inlet to Outlet Differential Temperature: 5°F (3°C)
above set point

Temperature Out: Field range: 80°F – 120°F (27°C – 49°C),
adjustable. Accurate within ±3°F (1.7°C)

Maximum Temperature: 200°F (93°C)

Maximum Pressure: 150psi (1034 kPa)

Minimum Flow: 0.5 gpm (1.9 lpm) @ 0.8psi (0.55 kPa)†

Maximum Flow: 20 gpm (76 lpm) @ 125psi (862 kPa)†

Maximum Pressure Differential between Hot & Cold Water
Supplies: 25%

Standards

Tested and Certified by NSF International

Listing: ASSE 1017, ASSE 1069, ASSE 1070 and IAPMO cUPC

† When tested in accordance with ASSE 1017, ASSE 1069 & ASSE 1070

Viega Pro-Press™ connections are optional factory installed fitting on each end of the approved/certified assembly.

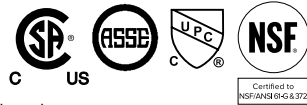

Capacity**

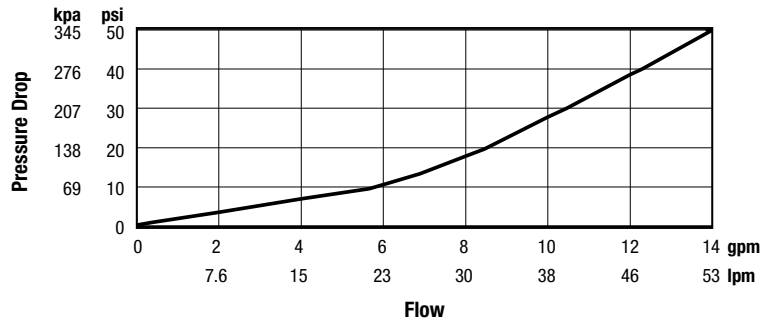

Flow curves are for reference. Actual flows may vary depending on system temperatures and/or pressures.
**Flow curve with integral inlet filters and check valves

Dimensions – Weights

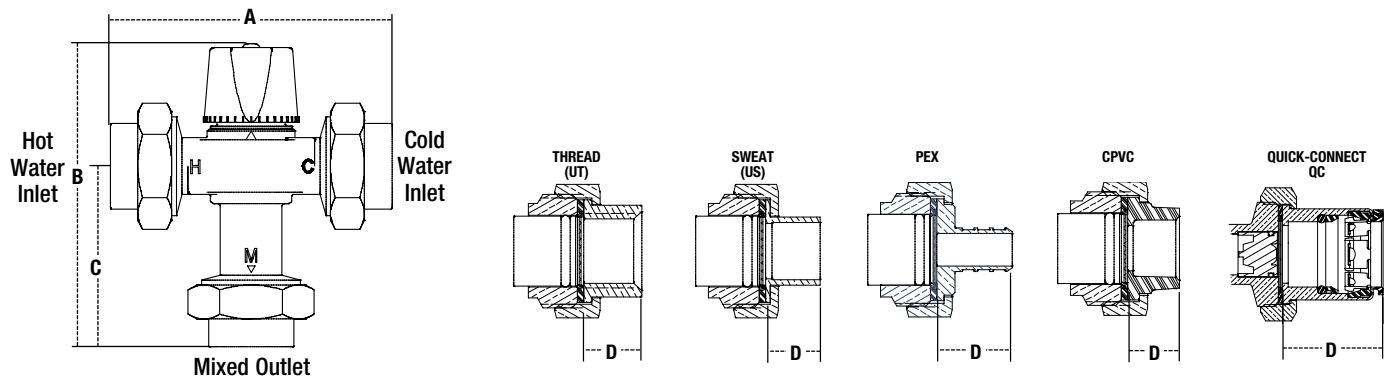

SIZE (DN)		MODEL	DIMENSIONS								WEIGHT	
in.	mm		A		B		C		D		lbs.	kg.
1/2	15	LFMMV-UT-M1	4 7/8	124	5 7/16	137	3 3/16	80	5 5/8	16	1.8	0.8
3/4	20		4 7/8	124	5 7/16	137	3 3/16	80	5 5/8	16	2.4	1.1
1	25		5 9/16	135	5 5/8	143	3 3/8	86	3/4	20	3.0	1.4
1/2	15	LFMMV-US-M1	4 13/16	123	5 3/8	137	3 1/8	80	5 5/8	15	1.7	0.8
3/4	20		5 5/16	135	5 5/8	143	3 3/8	86	7/8	22	2.3	1.0
1	25		5 9/16	148	5 7/8	149	3 3/8	92	1 1/8	28	2.9	1.3
1/2	15	LFMMV-PEX-M1	5 1/4	133	5 9/16	142	3 5/16	85	1 3/16	21	1.8	0.8
3/4	20		5 1/2	140	5 1 1/16	145	3 7/16	88	1 5/16	24	2.5	1.1
1	25		5 7/8	149	5 7/8	150	3 5/8	93	1 1/8	29	3.1	1.4
1/2	15	LFMMV-CPVC-M1	4 3/4	121	5 5/16	136	3 1/16	79	9/16	14	1.6	0.7
3/4	20		5 1/4	133	5 9/16	142	3 5/16	85	1 3/16	21	2.2	1.0
1	25		5 1 1/16	144	5 1 3/16	147	3 9/16	90	1	26	2.6	1.2
1/2	15	LFMMV-QC-M1	6 3/8	168	6 1/4	159	4	102	1 1/2	38	2.1	0.9
3/4	20		6 15/16	177	6 7/16	163	4 3/16	106	1 1 1/16	42	2.8	1.3
1	25		7 1/8	181	6 1/2	165	4 1/4	108	1 3/4	44	3.5	1.6

Note: Consult factory for dimensions w/press



USA: T: (978) 689-6066 • F: (978) 975-8350 • Watts.com
 Canada: T: (905) 332-4090 • F: (905) 332-7068 • Watts.ca
 Latin America: T: (52) 81-1001-8600 • Watts.com