

**Data Sheet | Item Number: 221-685**

COMPACT Splicing Connector; for all conductor types; for Ex e applications; max. 6 mm<sup>2</sup>; 5-conductor; with levers; transparent housing; Operating temperature (max.): 105 °C; 6,00 mm<sup>2</sup>; transparent

<https://www.wago.com/221-685>



Color:  transparent

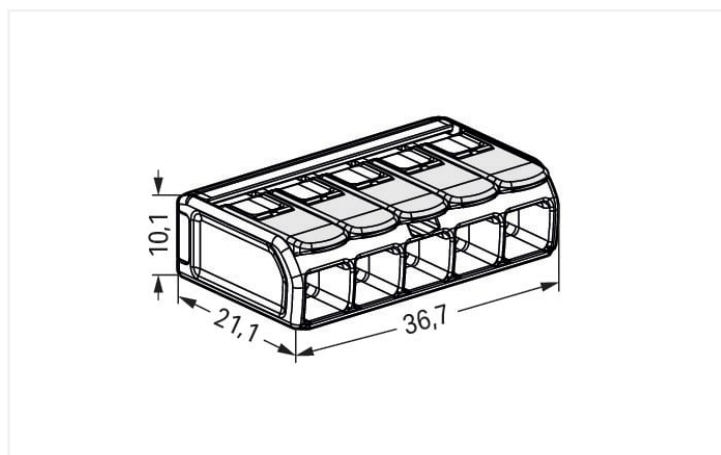

Dimensions in mm

## Your benefits:

- Ease of use – pull the lever up, insert a conductor and push the lever back down
- Available as 2-, 3- and 5-wire connectors
- Easily terminate conductors from 0.5 to 6 mm<sup>2</sup>
- Connection of all conductor types
- Time savings for installers and device manufacturers
- Quickly install devices with higher power consumption
- Safely install long cable runs with larger conductor cross sections
- Mounting carrier for installation conforms to standards
- Working voltages of 275 V or 440 V
- Custom carriers are possible
- ATEX (Ex 2 II G), IECEx (Ex eb IIC Gb) Zone 1, 2
- IECEX (Ex eb IIC Gb), American Ex (AEx eb IICGb) / Class 1, Zone 1

## Notes

## Safety information

The permissible operating voltage of the connector with carrier (440 V or 275 V) depends on the mounting type.

## Safety information 2

Only approved in conjunction with a mounting carrier (221-511). Other carriers are possible, see certificate/file.

The connectors must be installed in an enclosure meeting the requirements of a recognized protection type per EN 60079-0, Section 1 or EN 60079-31.

When installing the connectors in an enclosure of protection type "eb" (increased safety) per EN 60079-7, the clearances and creepage distances of Table 2 for this standard must be observed. See point 1 for the use of accessories. The connectors can be used both in Group II and Group I, as the standard requirements are identical in this case.

The use of these components requires a new assessment by a notified certification agency.

## Electrical data

## Ratings per IEC/EN

Ratings per	IEC/EN 60079-7
-------------	----------------

## Ratings per UL 1059

Approvals per	UL 60079
---------------	----------

Rated voltage UL (Use Group C)	440 V
--------------------------------	-------

Rated current UL (Use Group C)	30 A
--------------------------------	------

## Ex information

Ratings per	ATEX: PTB 19 ATEX 1001 U / IECEx: PTB 19.001 1U (Ex eb IIC Gb)
-------------	--

Rated voltage EN (Ex e II)	440 V
----------------------------	-------

Rated current (Ex e II)	37 A
-------------------------	------

## Connection data

Connection points	5
-------------------	---

Total number of potentials	1
----------------------------	---

## Connection 1

Connection technology	CAGE CLAMP®
-----------------------	-------------

Actuation type	Lever
----------------	-------

Connectable conductor materials	Copper
---------------------------------	--------

Nominal cross-section	6 mm <sup>2</sup> / 10 AWG
-----------------------	----------------------------

Solid conductor	0.5 ... 6 mm <sup>2</sup> / 20 ... 10 AWG
-----------------	---

Stranded conductor	0.5 ... 6 mm <sup>2</sup> / 20 ... 10 AWG
--------------------	---

Fine-stranded conductor	0.5 ... 6 mm <sup>2</sup> / 20 ... 10 AWG
-------------------------	---

Strip length	12 ... 14 mm / 0.47 ... 0.55 inches
--------------	-------------------------------------

Wiring direction	Side-entry wiring
------------------	-------------------

### Physical data

Width	36.7 mm / 1.445 inches
Height	10.1 mm / 0.398 inches
Depth	21.1 mm / 0.831 inches

### Material data

Note (material data)	<a href="#">Information on material specifications can be found here</a>
Color	transparent
Material group	IIIa
Insulation material	Polycarbonate (PC)
Flammability class per UL94	V2
Fire load	0.143 MJ
Actuator color	light gray
Weight	7.1 g

### Environmental requirements

Ambient temperature (storage)	-40 ... +60 °C
Continuous operating temperature	-55 ... +105 °C

### Commercial data

ETIM 8.0	EC000446
ETIM 7.0	EC000446
PU (SPU)	150 (15) pcs
Packaging type	Box
Country of origin	CH
GTIN	4055143860581
Customs tariff number	85369010000

### Approvals / Certificates

#### General approvals



Approval	Standard	Certificate Name
CB DEKRA Certification B.V.	IEC 60998	NL-81003
ENEC 05 DEKRA Certification B.V.	EN 60998	71-123784
UL Underwriters Laboratories Inc.	UL 486C	E69654

#### Declarations of conformity and manufacturer's declarations

Approval	Standard	Certificate Name
EU-Declaration of Confor- mity WAGO GmbH & Co. KG	-	-
UK-Declaration of Confor- mity WAGO GmbH & Co. KG	-	-

Approvals for marine applications



Approval	Standard	Certificate Name
LR Lloyds Register	EN 60998	LR22207029TA

Approvals for hazardous areas



Approval	Standard	Certificate Name
AEx Underwriters Laboratories Inc.	UL 60079	E185892 (AEx eb IIC resp. Ex eb IIC)
CCC CNEX	GB/T 3836.3	2020312313000185 (Ex eb IIC Gb, Ex eb I Mb)
IECEX Physikalisch Technische Bundesanstalt	IEC 60079-0	IECEX PTB 19.001 1U (EX eb IIC Gb, Ex eb I Mb)

Downloads

Environmental Product Compliance

Compliance Search
Environmental Product Compliance 221-685 <a href="#">↓</a>

Documentation

Additional Information
Technical Section pdf 2142.18 KB <a href="#">↓</a>

Bid Text
ausschreiben.de 221-685 <a href="#">↓</a>

CAD/CAE-Data

CAD data
2D/3D Models 221-685 <a href="#">↓</a>

CAE data
EPLAN Data Portal 221-685 <a href="#">↓</a>
ZUKEN Portal 221-685 <a href="#">↓</a>

Installation Notes

Conductor termination

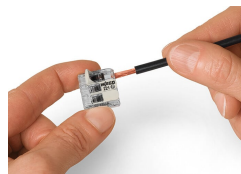
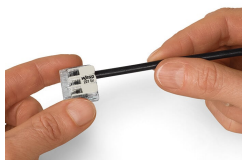
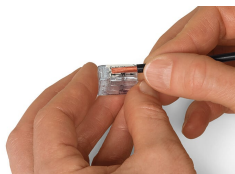

Strip conductor to 11 mm (0.43 inch).

Then, lower the lever to close the clamp.

Termination: Lift the lever to open the clamping unit and insert a stripped conductor.

## Installation

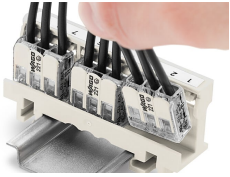

Inserting a connector into the mounting carrier.

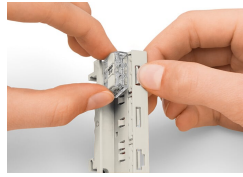

Removing a connector from the mounting carrier.

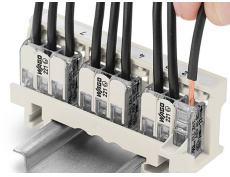

Removing a conductor.

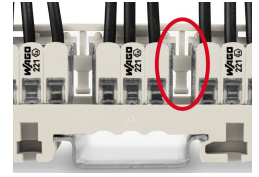

Mounting type (440 V)  
Using spacers between the connectors.

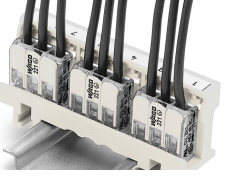

Mounting type (440 V)  
Vertical mounting on DIN-35 rail

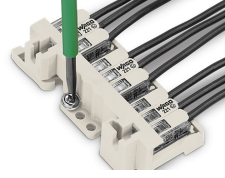

Mounting type (440 V)  
Horizontal screw mounting on a flat surface



Mounting type (440 V)  
Mounting the carrier via non-conductive screws.

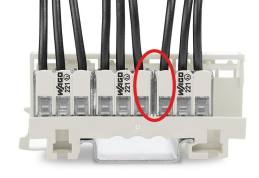

Mounting type (275 V)  
No spacers are used between the connectors.

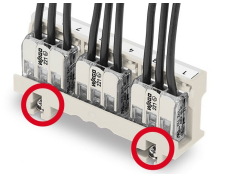

Mounting type (275 V)  
Mounting the carrier using conductive screws.

## Testing

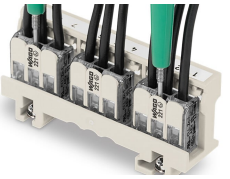

Easily test inserted connectors in the carrier –  
however they are mounted.