

599 Series Zone Valves

SFA/SFP Electronic Valve Actuator 2-Position Control

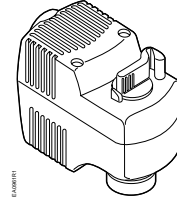

Product Description

The SF Series actuator requires a 24 Vac, 120 Vac, 208 Vac, or 277 Vac Class-2 supply signal to control Siemens Zone Valves with a 1/10-inch (2.5 mm) stroke.

Warning/Caution Notations

WARNING:		Personal injury or loss of life may occur if you do not follow a procedure as specified.
CAUTION:		Equipment damage, or loss of data may occur if you do not follow a procedure as specified.

Product Numbers

	Actuator Model	Power Supply	Actuator Code
Normally Open	SFP71U	24 Vac	243
	SFP11U	120 Vac	241
	SFP277U/25	277 Vac	- *
	SFP208U/25	208 Vac	- *
Normally Closed	SFA71U	24 Vac	242
	SFA11U	120 Vac	240
	SFA208U/25	208 Vac	- *
	SFA277U/25	277 Vac	- *

* Actuator only with 2.5-meter cable, not available as an assembly.

Contents

One actuator

Required Tools

- Small flat-blade screwdriver
- Wire stripper

Estimated Installation Time

20 minutes

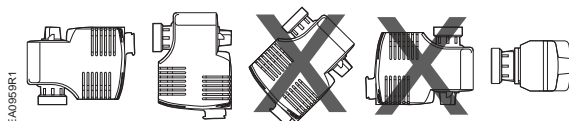

Figure 1. Acceptable Mounting Positions.

The vertical position is recommended for mounting.

Prerequisites



WARNING:

1. If mounting the actuator to a valve already in line:
 - Close the shut-off valves in the piping (upstream first, then downstream).
 Or
 - Switch off the pump to allow the differential pressure in the valve to drop.
2. Disconnect the controller power before replacing the actuator.

Installation

Mounting the SFP Actuator to a Valve

1. Place the actuator on the valve and firmly hand-tighten the coupling piece.
2. Connect the wires. See *Wiring*.

Mounting the SFA Actuator on a Valve

CAUTION:

The black actuator attachment support ring must be in place on top of the valve bonnet before installing the actuator.



If the support ring is not in place, damage to the actuator connection may result.

1. Rotate the manual override lever and latch.
2. Place the actuator on the valve and firmly hand-tighten the coupling piece.



CAUTION:

Failure to fully rotate the manual override handle before hand tightening will hinder proper valve close off.

3. Release manual override handle.
4. Connect the wires. See *Wiring*.

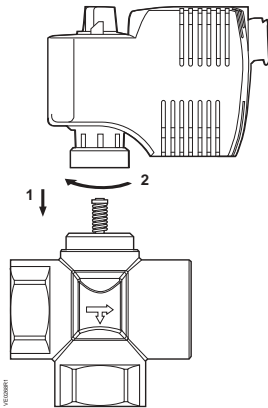

Figure 2. Mounting the Actuator on a Valve.

The installation is now complete.

Removing the Actuator from a Valve

1. Disconnect the wiring.
2. Unscrew actuator-coupling piece from the valve body threads.
3. Remove the actuator from the valve.

Wiring

- All wiring must conform to NEC and local codes and regulations.
- Use earth ground isolating step-down Class 2 transformers.

NOTE: Do not use autotransformers.

- Determine the supply transformer rating by summing the total VA of all actuators used. The maximum rating for a Class 2 step-down transformer is 100 VA.

NOTE: It is recommended that one transformer power no more than 10 actuators.

- SFA71U/SFP71U 24 Vac actuators: Wiring connection can be made inside the actuator housing (remove the housing top for access).
- Line voltage actuators: Wiring connection requires junction box and flex conduit no further than 15 inches (381 mm) from actuator.

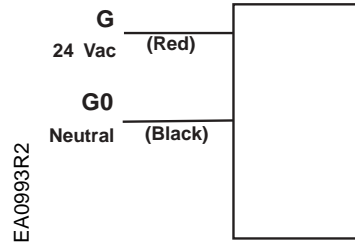

CAUTION:
 G0 and G must be properly wired for correct function and full life of the actuator.

Figure 3. 24 Vac Actuator Wiring Diagram.

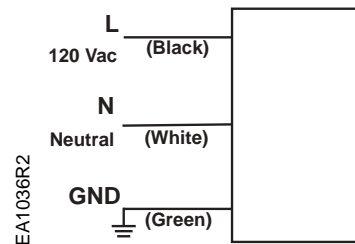

Figure 4. 120 Vac Actuator Wiring Diagram.

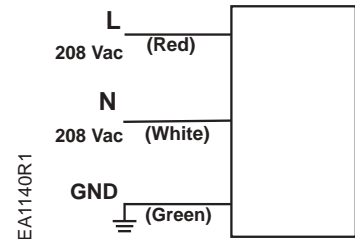

Figure 5. 208 Vac Actuator Wiring Diagram.

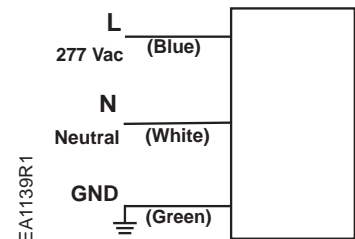
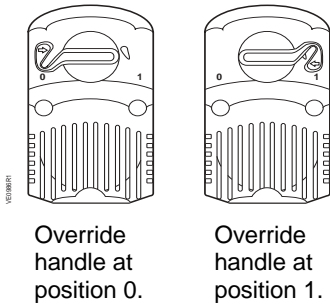

Figure 6. 277 Vac Actuator Wiring Diagram.

Manual Override

For manual positioning, rotate the manual override handle clockwise 180°, and squeeze it to latch around protruding stop. See Figure 7.

NOTE: The actuator will automatically unlatch when power is applied.



NOTE:
 The "0" and "1" position markings are intended for reference only and not stroke measurement.

Figure 7. Manual Override Handle Position.

When the manual override handle is at the "0" position, the output shaft is retracted if the actuator is normally open, or extended if normally closed. See Figure 8.

When the Manual Override handle is rotated to position 1, the reverse is true. See Figure 9.

Start-Up

Check the wiring and the position indication.

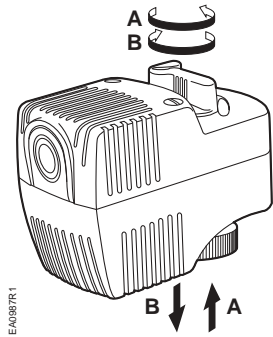

(A) Allow handle to turn counterclockwise to retract spindle.

(B) Turn handle clockwise to extend spindle.



CAUTION:
 To avoid damage to actuator, DO NOT manually assist spring return.

Figure 8. Normally Open. (SFP Series).

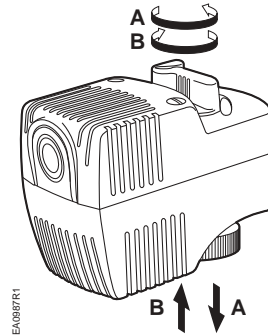

(A) Allow handle to turn counterclockwise to extend spindle.

(B) Turn handle clockwise to retract spindle.



CAUTION:
 To avoid damage to actuator, DO NOT manually assist spring return.

Figure 9. Normally Closed (SFA Series).

Troubleshooting

Check the wiring for the proper connections.

References

Technical Instructions
 SFA/SFP Electronic Valve Actuator
 24 Vac or 120 Vac, 2-Position Control
 Zone Valve Assemblies TB254

Document Number
 155-321P25
 155-291

Dimensions

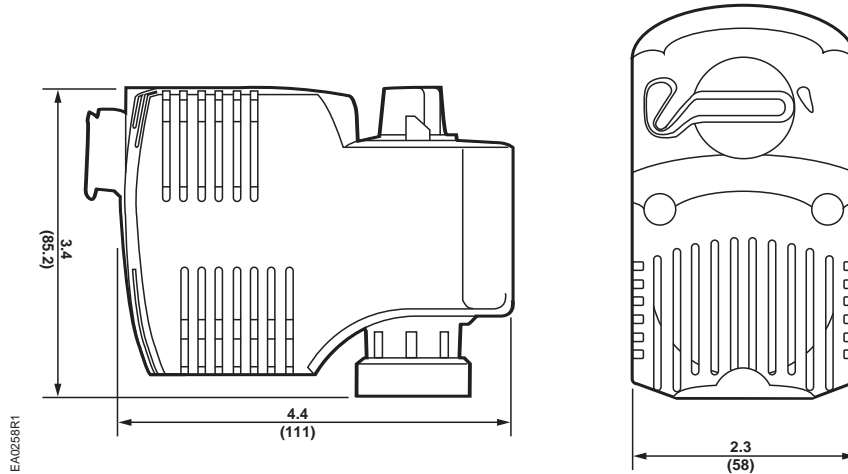

Figure 10. Dimensions of the SF Series Actuator Shown in Inches (Millimeters).

Service Envelope

Minimum access space recommended: 8 inches (200 mm) above the actuator.

Information in this publication is based on current specifications. The company reserves the right to make changes in specifications and models as design improvements are introduced. Other product or company names mentioned herein may be the trademarks of their respective owners.
© 2005 Siemens Building Technologies, Inc.