

Panasonic

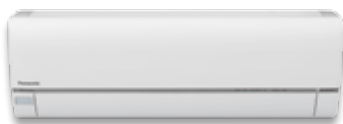

INVERTER

AIR CONDITIONING and HEAT PUMP PRODUCTS



The History of Panasonic Air Conditioning

The Panasonic Air Conditioning Group has grown into a global company through its continuous quest for product innovations and technology. The group has evolved from manufacturing compressors to providing comprehensive air conditioning solutions. This has earned Panasonic, the reputation as the most trusted brand for superior energy-efficiency and reliable products.

- | | | |
|--|---|--|
| <p>1958 Started production and sales of Home Coolers
The Electrical Appliance Business Group (Kadoma) started cooler production in March 1958. Started sales in May under the "Home Cooler" name.</p> |  | <p>1998 Introduced GAS Heater Air Conditioner 14KGS11</p> |
| <p>1961 Started exports of Home Coolers</p> | | <p>2001 Introduced first VRF "ECO-Multi" to USA</p> |
| <p>1965 Launched Room Coolers</p> |  | <p>2003 Launched first R410a refrigerant Ductless A/C to USA
Launched EcoCute as a result of better energy-saving technology
Launched accumulator-less, high-efficiency, CO₂ scroll compressor for EcoCute
Began production of Multi-split packaged air conditioner (mini-VRF)</p> |
| <p>1968 Began development of Rotary Compressors
Later, their high efficiency and high quality attracted domestic and overseas air conditioner manufactures. Began external sales.</p> | | <p>2005 Launched air conditioner automatic filter cleaning function (AC robot)
Product became extremely successful in the Japanese market. Since then, Panasonic launched a series of innovative products such as airstream robots and motion sensors which significantly improved Panasonic's air conditioner market share.</p> |
| <p>1972 Established overseas business base in Malaysia
MAICO was established in Malaysia as the Aircon Group's first overseas base. From this time, MAICO started to export to Japan, Indonesia, Australia, and other markets. Panasonic started operating a twin-base system with a presence in Japan and Malaysia.</p> |  | <p>2006 Renewed ECO-Multi to ECO-i, revised lineup to inverter driven
Aggregated global production of Panasonic compressors reached 200 million units</p> |
| <p>1983 Launched inverter Air Conditioner
Started sales of Panasonic's first inverter air conditioners and has since gained increasing popularity. Inverter became the future technology of air conditioner market.
Launched Ductless Air Conditioners to USA</p> | | <p>2008 In 2008 Energy Conservation Grand Prizes, EcoCute won its first Director General Prize of Agency of Natural Resources and Energy, while Panasonic air conditioner won the Chairman Prize of the Energy Conservation Center of Japan Started Air to Water heat pump business in Europe</p> |
| <p>1985 Began development of Scroll Compressors
Began development of scroll compressors, offering high efficiency, low noise, and low vibration in comparison to rotary compressors.</p> |  | <p>2009 Established air conditioner dedicated sales company in Europe (PHAAE)
Panasonic HA Air-Conditioning Europe (PHAAE) strengthened the commercial air conditioning business.</p> |
| <p>1989 Introduced Simultaneous Heat & Cool VRF</p> | | <p>2011 Integration of Sanyo HVAC USA into Panasonic Corporation of North America.</p> |
| <p>1990 Launched world's first Compact Scroll Compressor-equipped Air Conditioner</p> | | <p>2013 Celebrating the 30th anniversary of marketing in the USA.
Serving the US Ductless market since 1983</p> |
| <p>1992 Developed industry's smallest outdoor air conditioning unit: "Chi-size"</p> | |  |
| <p>1993 Established Matsushita-Wanbao (Guangzhou) Air Conditioner (MWAC)
Established Matsushita-Wanbao (Guangzhou) Compressor (MWCC)
Established Matsushita Air Conditioner Engineering (Matsushita ACE)</p> | | <p>2014 SYSTEM 5 and Wireless Communication</p> |
| <p>1995 Started the export of VRF</p> | |  |

Technological Milestones

1998 | **Introduced revolutionary Gas Heater Air Conditioner 14KGS11.**

That maintains a consistent heating performance level, regardless of how much the ambient temperature goes down outside.



Heating Operation Schematic

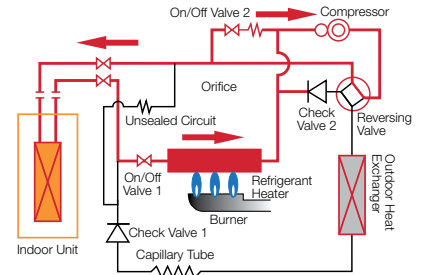

2001 | **Launched VRF "Eco-Multi" to the US market.**

Eco-Multi was displayed at the AHR show, and was introduced to other ductless manufacturers. It's the new individual air-conditioning system that effectively combines a power control compressor and an electronic refrigerant control valve.



2003 | **First R410a driven ductless model, 24KS62R, was introduced.**

Again, blazed a trail to other ductless manufacturers.



2013 | **EXTERIOS *XE* Series**

SEER 28.5 Highest Efficient model in Industry as of 2013/March

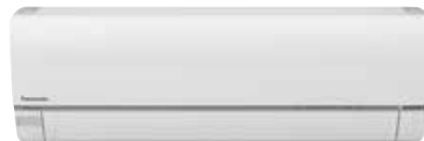

2014 | **Introduce EXTERIOS *E* Series to the US market.**

SEER 23 Built with the latest advanced technology for maximum energy savings



Air Conditioners and Heat Pumps Line-Up

Panasonic: Your Best Choice in Mini Split Air Conditioning and Heat Pump Systems

Since 1983, Panasonic's Mini Split Air Conditioner and Heat Pump products offer a wide range of versatile solutions for cooling and heating requirements for single or multiple rooms. The indoor unit (evaporator) is mounted inside a room and it is connected to the outdoor unit (condenser) via refrigerant lines and inter-unit wiring through a 3-1/2" opening in the wall. Since no ductwork is required, installation is simple, fast and efficient. Ducted models are also available. The indoor unit has been uniquely designed to provide whisper quiet operation while delivering comfort throughout the room (s). Panasonic Mini Split Systems are stylish and offer whisper-quiet operations, quality and reliability you can count on.

HEAT PUMP MODELS

Btu/h	9,000	12,000	18,000	24,000	26,000	30,000	36,000	42,000	
MODEL (System)	XE9PKUA, E9NKUA E9RKUA	XE12PKUA, E12NKUA E12RB4U, E12RKUA	E18NKUA, E18RB4U E18RKUA	E24NKUA, E24RKUA	26PEK1U6, 26PET1U6 26PEU1U6, 26PEF1U6	KE30NKU	KE36NKU, 36PET1U6 36PEU1U6, 36PEF1U6	42PET1U6 42PEU1U6	
Low Ambient Type HEAT PUMP WITHOUT HEATER	EXTERIOS Wall Mounted 								
	CS-XE9PKUA CU-XE9PKUA	CS-XE12PKUA CU-XE12PKUA							
	EXTERIOS Wall Mounted 								
	CS-E9RKUAW CU-E9RKUA	CS-E12RKUAW CU-E12RKUA	CS-E18RKUAW CU-E18RKUA	CS-E24RKUAW CU-E24RKUA					
	Wall Mounted								
	CS-E9NKUAW CU-E9NKUA	CS-E12NKUAW CU-E12NKUA	CS-E18NKUA CU-E18NKUA	CS-E24NKUA CU-E24NKUA			CS-KE30NKKU CU-KE30NKKU	CS-KE36NKKU CU-KE36NKKU	
	Wall Mounted								
	S-26PK1U6								
Ceiling Suspended									
S-26PT1U6						S-36PT1U6	S-42PT1U6		
Ceiling Recessed									
CS-E12RB4UW	CS-E18RB4UW			S-26PU1U6	S-36PU1U6	S-42PU1U6			
Concealed Duct									
S-26PF1U6					S-36PF1U6				
Outdoor									
CU-E12RB4U	CU-E18RB4U			U-26PE1U6	U-36PE1U6	U-42PE1U6			



MULTI ZONE MODELS

		Btu/h	7,000	9,000	12,000	7,000	9,000	12,000	18,000	24,000	7,000	9,000	12,000	18,000	24,000
HEAT PUMP	Indoor Unit	Wall Mounted	 CS-ME7RKUA/ CS-E9RKUAW/CS-E12RKUAW			 CS-ME7RKUA/CS-E9RKUAW/ CS-E12RKUAW			 CS-E18RKUAW/ CS-E24RKUAW		 CS-MKE7NKU	 CS-MKE9NKU	 CS-MKE12NKU	 CS-MKE18NKU	 CS-MKE24NKU
		Ceiling Recessed	 CS-E12RB4UW			 CS-E12RB4UW			 CS-E18RB4UW			 CS-MKE9NB4U	 CS-MKE12NB4U	 CS-KE18NB4UW	
	Outdoor Unit	Outdoor	 CU-2E18NBU				 CU-5E36QBU				 CU-3KE19NBU		 CU-4KE24NBU		 CU-4KE31NBU

COOLING ONLY MODELS / LOW AMBIENT TYPE

		Btu/h	30,000	36,000
Low Ambient Type	AIR CONDITIONER	MODEL (System)	KS30NKUA	KS36NKUA
		Wall Mounted	 CS-KS30NKU CU-KS30NKUA	 CS-KS36NKU CU-KS36NKUA

* Please refer to the model identification on the back of this catalog.

Model Feature Chart

OP: Option

Features Chart

		HEAT PUMPS									LOW-AMBIENT AIR CONDITIONERS
		XE9PKUA XE12PKUA	E9RKUA E12RKUA E18RKUA E24RKUA	E9NKUA E12NKUA E18NKUA E24NKUA	KE30NKU KE36NKU		26PEK1U6				KS30NKUA KS36NKUA
	Wall Mounted										
	Ceiling Suspended							26PET1U6 36PET1U6 42PET1U6			
	Ceiling Recessed					E12RB4U E18RB4U			26PEU1U6 36PEU1U6 42PEU1U6		
	Concealed Duct									26PEF1U6 36PEF1U6	
	ECONAVI	●	●								
	Room Freeze Protection	●	●								
	Microprocessor-Controlled Operation	●	●	●	●	●	●	●	●	●	●
	Wireless Remote Control	●	●	●	●	●	●	OP	OP	OP	●
	Wired Remote Control	OP	OP	OP	OP	OP	OP	●	●	●	OP
	Self-Diagnosing Function	●	●	●	●	●	●	●	●	●	●
	Dry Mode	●	●	●	●	●	●	●	●	●	●
	5 Fan Speeds and Automatic Fan Operation	●	●	●	●	●	●	●	●	●	●
	Air Sweep Control	●	●	●	●	●	●	●	●	-	●
	Louver Control	●	●	●	●	●	●	●	●	-	●
	Automatic Heating and Cooling Changeover	●	●	●	●	●	●	●	●	●	-
	Night Setback Mode for Cooling and Heating	-	-	-	-	●	-	-	-	-	●
	Hot Start Heating System	●	●	●	●	●	●	●	●	●	-
	24-Hour Clock with ON/OFF Program Timer	●	●	●	●	●	●	●	●	●	●
	1-Hour OFF Timer	-	-	-	●	●	-	-	-	-	●
	Weekly Timer	-	-	-	-	-	OP	●	●	●	-
	System Controller	-	-	-	-	-	OP	OP	OP	OP	-
	Filter Sign	●	●	●	-	-	●	●	●	●	-
	Automatic Restart Function after Power Failure	●	●	●	●	●	●	●	●	●	●
	Fresh Air Intake	-	-	-	-	●	-	OP*	OP	OP*	-
	Branch Extension	-	-	-	-	●	-	-	●	●	-
	Built-In Drain Pump	-	-	-	-	●	-	-	●	●	-
	Low Ambient Operation	●	●	●	●	-	●	●	●	●	●
	Electric Expansion Valve	●	●	●	●	●	●	●	●	●	●
	ODP=0 Refrigerant	●	●	●	●	●	●	●	●	●	●
	Quiet Mode	●	●	●	●	●	-	-	-	-	●
	Anti-microbial Filter	-	-	●	-	-	-	-	-	-	-
	Blue Fin Condenser	●	●	●	-	-	-	-	-	-	●

* Field Supplied

Features

ECO NAVI ECONAVI

ECONAVI features intelligent Human Activity Sensor and new technologies that can detect human activity and absence, and optimize air conditioner operation according to room conditions.

Room Freeze Protection*

Room Freeze Protection mode helps prevent plumbing damage due to sub-Freezing Temperature. This mode automatically turns on the compressor for heat pump operation if the room temperature falls to about 46°F.

*This function may not be performed if the unit is not powered, or if the unit is unable to operate such as in protection mode. Please consult with the HVAC installers or professional for details.

Microprocessor-Controlled Operation

Microprocessor control ensures that the temperature and humidity levels in the room are always comfortable.

Wireless Remote Control

Panasonic's infrared Remote Control with an easy-to-read LCD Display, gives the user the capability to adjust & set: temperature, sweep (louver control), fan speeds, timer and more, for complete automatic operation.

DRY Dry Mode

By coupling compressor and fan operation, intermittent operation can be precisely controlled according to room temperature, so that air is efficiently dehumidified.

5 Fan Speeds and Automatic Fan Operation

Convenient microprocessor control automatically adjusts fan speed to High, Medium or Low. According to room temperature to maintain a comfortable airflow throughout the room.

Air Sweep Control

The air sweep function moves the louver up and down in the air outlet, directing air in a "sweeping" motion around the room and providing comfort in every corner.

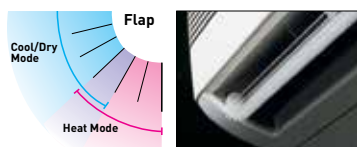

Louver Control

Louver can be manually set to the desired angle by remote control.

Automatic Heating and Cooling Changeover

After setting the temperature and functions you desire, just relax. If the room temperature is higher than the set temperature, cooling operation begins. If the room temperature is lower than the set temperature, heating operation begins. During normal thermostat cycle operation, cooling and heating operations automatically change in accordance with set temperature, time and room temperature (Single Zone Heat Pump unit only).

1H Timer 1-hour OFF Timer

When this button is pushed either while the unit is operating or while it is stopped, the unit will operate for one hour, then switch off automatically.

24H PROGRAM 24-hour Clock with ON/OFF Program Timer

The remote control unit allows you to set a wide variety of timer-based operations. Such functions include automatic ON/OFF with a timer setting, same time ON/OFF every day, ON timer, OFF timer and Combination timer.

NIGHT SETBACK Night Setback Mode for Cooling and Heating

Cooling and DRY Mode: With the Night Setback Mode, the air conditioner automatically raises the setting temperature 2°F after 30 minutes, and then another 2°F after the next 30 minutes.

Heating Mode: With the Night Setback Mode, the setting temperature is automatically lowered 4°F after 30 minutes, and then another 4°F after the next 30 minutes. This saves energy without sacrificing comfort and is ideal for gentle cooling and heating.

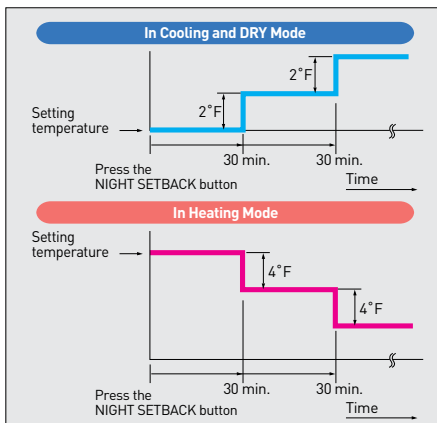

Automatic Restart Function after Power Failure

This feature allows the system to automatically resume operation at its preset program, after power is restored from a power failure when the remote control is in the room.

Hot Start Heating System

Right from the start, air is warm and comfortable. The Hot Start Heating System prevents any cold blasts at the beginning while the heat pump is warming up (Heat pump unit only).

DP Built-In Drain Pump

Max. head 20 inches from the discharge of the indoor unit. Condensation pump is only for allowing drain line to meet minimum gravity flow requirements.

ELECTRIC Electric Refrigerant Control Valve

The circulation volume of the refrigerant is controlled by a pulse type electric control valve. In order to attain optimum efficiency, when the power is switched ON, the opening degree of the electric control valve is controlled between 90 and 480 steps.

Quiet Mode

LOW, low fan speed for extra quiet operation.

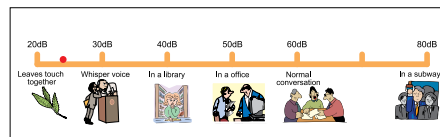

Filter Sign

Filter sign informs you when filter maintenance is necessary.

K1/T1/U1/F1 series with CZ-RTC2
XE/E/S series with CZ-RDC516C-1



(Example of CZ-RTC2)

Self-Diagnosing Function

Units are equipped with Self-Diagnosing Function (methods are difference depending on the models). This makes it easier to diagnose malfunctions, greatly reducing service labor (Wired remote controller).



(Example of CZ-RTC2)

Anti-microbial Filter

Anti-microbial Filter by 3M. This filter is treated to inhibit the growth of mold and mildew, and helps create clean air.

Test Comparison

	Microbial Growth Rating	
	7 days	28days
Anti-microbial Filter	No growth	No growth
Normal Filter Paper	60% growth	60% growth

*Tested per ASTM G21-96

Blue Fin Condenser

Condensers can take a beating from exposure to salty air, rain and other corrosive factors. Panasonic has extended the life of its condensers with an original anti-rust coating. Tested for 2,000 salt spray hours.

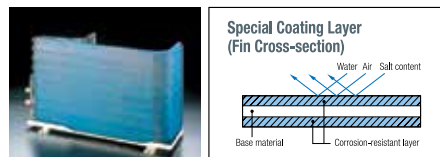

Panasonic sets another milestone in the Mini-Split History...

EXTERIOS - the latest breakthrough in energy efficiency and high performance with Inverter technology up to SEER 28.5 and up to HSPF 12.5

EXTERIOS **XE**

EXTERIOS **E**

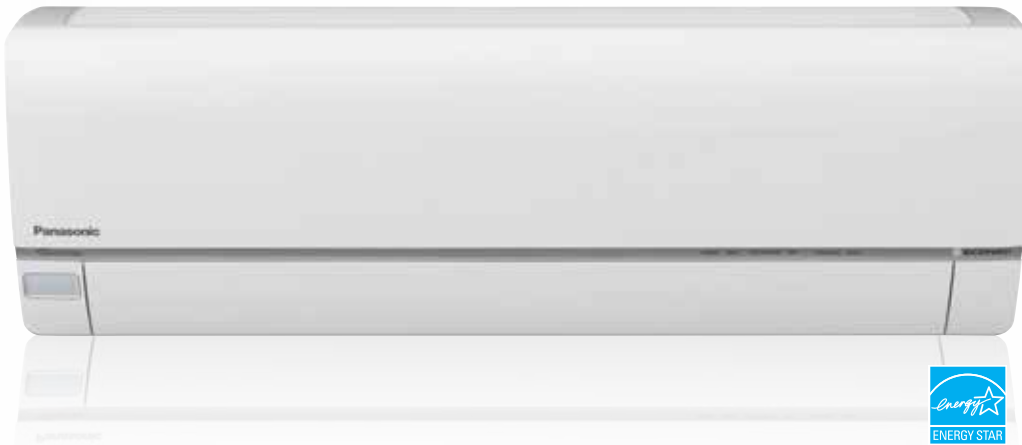

Wireless Remote Controller



Wired Remote Controller (CZ-RD516-1) (Optional)



**SEER
28.5**

High Energy Efficiency up to SEER 28.5

Breakthrough technologies, such as the inverter, enables the highest energy efficiency. Thanks to this exceptional performance, you will enjoy even more comfort and cost savings.

**LOW
AMBIENT
OPERATION**

Powerful Heating at Low Ambient Temperatures

Offers reliable heating with full capacity down to 5°F.

Max Capacity (Heat)

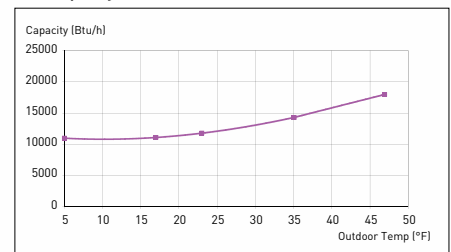

INVERTER

Inverter Technology

Panasonic's inverter technology provides optimum power control and extremely efficient operation by modulating the compressor capacity. The result is efficient and flexible operation using less electricity.

Panasonic ductless mini split systems are designed to care for you

With over 50 years of experience of exporting to more than 125 countries around the world, Panasonic is unquestionably one of the leaders in the air conditioning business. Panasonic has produced more than 200 million compressors and has manufactured high quality air conditioners.





Provides Optimum Performance While Reducing Energy Usage

Panasonic's inverter technology constantly adjusts its compressor rotation speed to provide maximum performance at all times. This extremely precise operation enables quick cooling or heating while reducing power consumption compared to conventional non-inverter units.

Reduces Electricity Consumption

Panasonic inverter air conditioners/heat pumps are designed to give you exceptional energy savings performance while ensuring you stay comfortable at all times.

Constant Comfort

Precise temperature control with a wide power output range enables an inverter air conditioner to meet different room occupancy levels – thus ensuring constant comfort.

Quick Cooling and Heating

Panasonic Inverter air conditioners can operate with higher cooling/heating power during the start up period to cool/heat the room faster than non-inverter models.

Whisper Quiet Operation

The indoor operating noise has been reduced by 5dB as the Inverter constantly varies its output power to enable more precise temperature control.

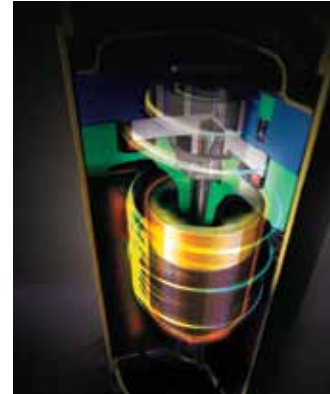

Wider Output Power Range

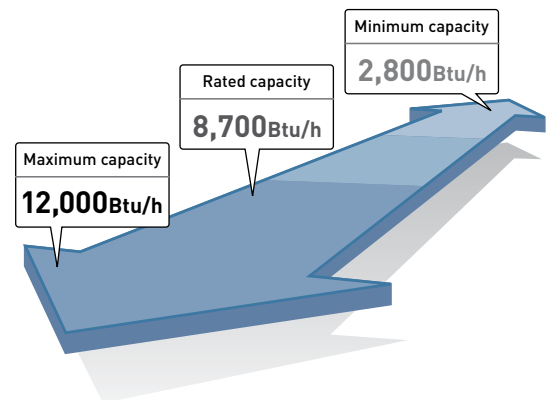

The Advantages of Inverter Control

Comparing inverter and non-inverter air conditioners to cars...

*Image of output power fluctuation

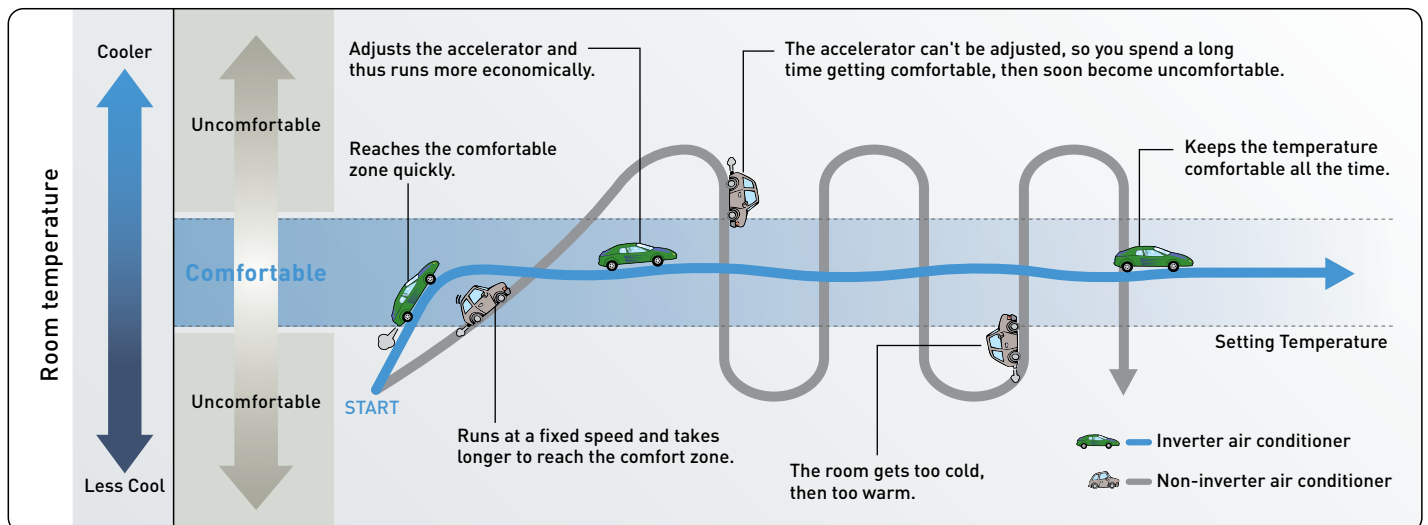

ECONAVI with Intelligent Eco Sensors



In 2007, Panasonic launched ECONAVI (Human Detection Technology) to its air conditioners. The ECONAVI sensors moderate the temperature in a room and senses when there is activity; which then automatically adjusts the temperature setting accordingly for maximum energy efficient operation. The absence detection feature switches to a slightly less powerful cooling mode when the room is empty.

Absence Detection

ECONAVI detects human absence from the room and raises the target temperature.

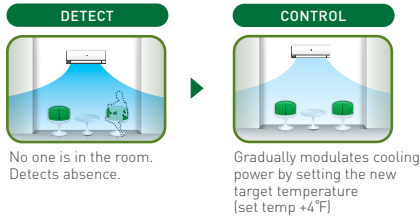

Activity Detection

ECONAVI detects changes in activity levels and reduces the cooling power by adjusting set temperature.

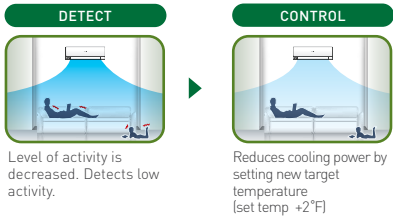

ECONAVI in cooling mode: *The target temperature set by ECONAVI will be restored automatically to the set temperature when the new condition is detected.



How Does ECONAVI Human Activity Work?

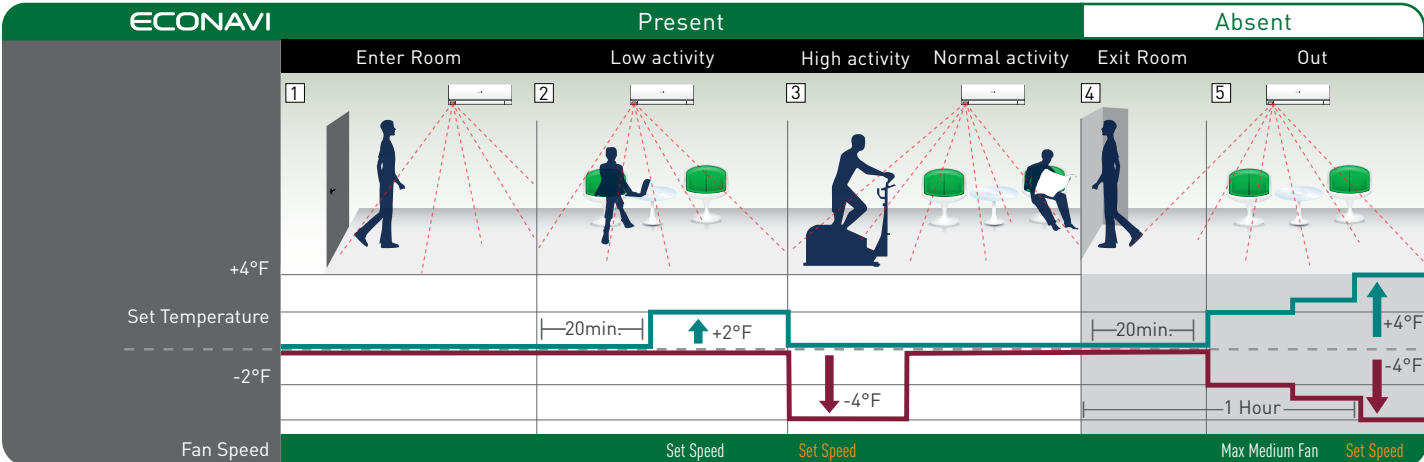

Legend: - - - Set Temperature — Cooling Power — Heating Power Remark: Set temperature on remote control display remains unchanged.

Wall-Mounted Heat Pumps

XE9PKUA / XE12PKUA

EXTERIOS XE

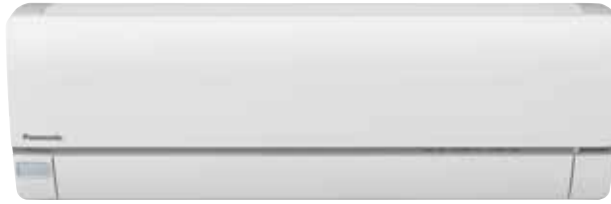

Indoor Unit
CS-XE9PKUA / CS-XE12PKUA



Wireless Remote Controller



Wired Remote Controller (CZ-RD516C-1) (Optional)

Outdoor Unit
CU-XE9PKUA / CU-XE12PKUA



Wall Mounted Heat Pumps

Model No.	XE9PKUA		XE12PKUA		
	Indoor Unit CS-XE9PKUA	Outdoor Unit CU-XE9PKUA	Indoor Unit CS-XE12PKUA	Outdoor Unit CU-XE12PKUA	
Performance & Electrical Ratings					
Capacity	Cooling	8,700 (2,800–12,000)		11,500 (2,800–14,000)	
	Heating	12,000 (3,000–18,000) (10,600 at 17°F)		13,800 (3,000–23,000) (13,500 at 17°F)	
Moisture Removal	High	1.3		2.3	
	High	405		530	
SEER	Cooling	28.5		25.5	
	Cooling	16.1		14.35	
HSPF	Heating	12.5		12.0	
	V, Phase, Hz	230/208V, 1PH, 60Hz		230/208V, 1PH, 60Hz	
Running Amps	Cooling	2.5 / 2.8		3.8 / 4.2	
	Heating	4.0 / 4.5		5.2/5.8	
Power Input	Cooling	540 (150–850)		800 (150–1,050)	
	Heating	860 (150–1,650)		1,150 (150–2,100)	
Back-up Heater	kW	---		---	
Fuse or Circuit Breaker Capacity	A	15		20	
Features					
Controls	Microprocessor		Microprocessor		
Low Ambient Control	Equipped		Equipped		
Wireless Controller	Included		Included		
Wired Remote Controller (optional)	CZ-RD516C-1		CZ-RD516C-1		
Fan Speeds	5 Speeds + Auto		5 Speeds + Auto		
Timer	24-hr Program		24-hr Program		
Air Deflection	Horizontal	Manual		Manual	
	Vertical	Automatic		Automatic	
Air Filter	Washable + Anti Microbial Filter		Washable + Anti Microbial Filter		
Refrigerant	R-410A		R-410A		
Refrigerant control	Electric Expansion Valve		Electric Expansion Valve		
Operation Sound	In (Hi / Me / Lo / Qt)	42 / 25 / 20		45 / 28 / 20	
	Outdoor (Hi)	48		49	
Refrigerant Piping	Type	Flare		Flare	
	Discharge	1/4"		1/4"	
	Suction	3/8"		1/2"	
Refrigerant Pipe Length	Ft.	Max. 66		Max. 66	
Elevation Difference*	Outdoor Above	Max. 49		Max. 49	
	Outdoor Below	Max. 49		Max. 49	
Dimensions & Weight					
Height	inches	11-5/8"	27-3/8"	11-5/8"	27-3/8"
Width	inches	34-9/32"	34-15/32"	34-9/32"	34-15/32"
Depth	inches	10-1/16"	12-5/8"	10-1/16"	12-5/8"
Net Weight	Lbs.	24.0	97.0	24.0	97.0

* This is maximum elevation difference when the indoor unit is located above the outdoor unit. (Refer to the table on the P.34 in the catalog for more detail.)

Wall-Mounted Heat Pumps

EXTERIOS E E9RKUA / E12RKUA

E18RKUA / E24RKUA NEW



Indoor Unit
CS-E9RKUAW / CS-E12RKUAW

ECONAVI ENERGY STAR

Indoor Unit
CS-E18RKUAW / CS-E24RKUAW

ECONAVI ENERGY STAR (E18 only)



Wireless Remote Controller



Wired Remote Controller (CZ-RD516-1) (Optional)



Wireless Remote Controller



Wired Remote Controller (CZ-RD516-1) (Optional)

Outdoor Unit
CU-E9RKUA / CU-E12RKUA

Blue Fin Condenser

Outdoor Unit
CU-E18RKUA / CU-E24RKUA

Blue Fin Condenser



Wall Mounted Heat Pumps									
Model No.	E9RKUA		E12RKUA		E18RKUA		E24RKUA		
Unit Model No.	Indoor Unit	Outdoor Unit	Indoor Unit	Outdoor Unit	Indoor Unit	Outdoor Unit	Indoor Unit	Outdoor Unit	
	CS-E9RKUAW	CU-E9RKUA	CS-E12RKUAW	CU-E12RKUA	CS-E18RKUAW	CU-E18RKUA	CS-E24RKUAW	CU-E24RKUA	
Performance & Electrical Ratings									
Capacity	Cooling	Btu/h		9,000 (4,100-10,200)	11,500 (4,100-13,300)	17,200 (5,800-19,800)	24,000 (5,800-27,200)		
	Heating	Btu/h		12,000 (4,100-14,100)	13,800 (4,100-16,300)	21,600 (5,800-22,000)	28,800 (5,800-29,200)		
Moisture Removal	High	Pints/H		1.3	1.7	3.0	7.6		
	High	CFM		425	450	670	670		
SEER	Cooling			23.0	22.5	19.5	19.0		
EER	Cooling			13.0	12.5	13.2	10.2		
HSPF	Heating			11.0	11.0	10.0	10.0		
Power Supply	V, Phase, Hz	230/208V, 1PH, 60Hz		230/208V, 1PH, 60Hz	230/208V, 1PH, 60Hz	230/208V, 1PH, 60Hz	230/208V, 1PH, 60Hz		
	Running Amps	Cooling	A	3.2 / 3.6	4.2 / 4.7	6.3 / 7.0	10.8 / 11.9		
	Heating	A	5.1 / 5.7	5.6 / 6.3	8.3 / 9.3	11.4 / 12.6			
Power Input	Cooling	W		690 (250-850)	920 (250-1,150)	1,300 (430-1,600)	2,350 (430-2,720)		
	Heating	W		1,120 (200-1,500)	1,250 (200-1,710)	1,750 (380-1,800)	2,500 (380-2,660)		
Back-up Heater		kW		---	---	---	---		
Fuse or Circuit Breaker Capacity	A	15		15	20	25			
Features									
Controls	Microprocessor		Microprocessor		Microprocessor		Microprocessor		
Low Ambient Control	Equipped		Equipped		Equipped		Equipped		
Wireless Controller	Included		Included		Included		Included		
Wired Remote Controller (optional)	CZ-RD516C-1		CZ-RD516C-1		CZ-RD516C-1		CZ-RD516C-1		
Fan Speeds	5 Speeds + Auto		5 Speeds + Auto		5 Speeds + Auto		5 Speeds + Auto		
Timer	24-hr Program		24-hr Program		24-hr Program		24-hr Program		
Air Deflection	Horizontal	Manual		Manual		Automatic		Automatic	
	Vertical	Automatic		Automatic		Automatic		Automatic	
Air Filter	Washable + Anti Microbial Filter		Washable + Anti Microbial Filter		Washable + Anti Microbial Filter		Washable + Anti Microbial Filter		
Refrigerant	R-410A		R-410A		R-410A		R-410A		
Refrigerant control	Electric Expansion Valve		Electric Expansion Valve		Electric Expansion Valve		Electric Expansion Valve		
Operation Sound	In (Hi / Me / Lo / Qt)	dB-A		40 / 25 / 20	43 / 28 / 20	47 / 39 / 36	48 / 40 / 37		
	Outdoor (Hi)	dB-A		47	48	49	51		
Refrigerant Piping	Type	Flare		Flare		Flare		Flare	
	Discharge	inches		1/4"	1/4"	1/4"	1/4"		
	Suction	inches		3/8"	1/2"	1/2"	5/8"		
Refrigerant Pipe Length	Ft.		Max. 65.6	Max. 65.6	Max. 100	Max. 100			
Elevation Difference*	Outdoor Above	Ft.		Max. 49.2	Max. 49.2	Max. 49.2	Max. 49.2		
	Outdoor Below	Ft.		Max. 49.2	Max. 49.2	Max. 49.2	Max. 49.2		
Dimensions & Weight									
Height	inches	11-7/16"	21-9/32"	11-7/16"	21-9/32"	11-7/16"	31-5/16"	11-7/16"	31-5/16"
Width	inches	34-9/32"	30-23/32"	34-9/32"	30-23/32"	42-5/32"	34-15/32"	42-5/32"	34-15/32"
Depth	inches	8-7/16"	11-13/32"	8-7/16"	11-13/32"	9-15/32"	12-5/8"	9-15/32"	12-5/8"
Net Weight	Lbs.	20.0	82.0	20.0	82.0	26.0	132.0	26.0	132.0

* This is maximum elevation difference when the indoor unit is located above the outdoor unit. (Refer to the table on the P.34 in the catalog for more detail.) ** Cooling only function

Wall-Mounted Heat Pumps

E9NKUA / E12NKUA



Indoor Unit
CS-E9NKUAW / CS-E12NKUAW



Outdoor Unit
CU-E9NKUA / CU-E12NKUA



Wireless Remote Controller



Wired Remote Controller (CZ-RD516C-1) (Optional)

E18NKUA / E24NKUA



Indoor Unit
CS-E18NKUA / CS-E24NKUA



(E18 Only)



Outdoor Unit
CU-E18NKUA / CU-E24NKUA



Wireless Remote Controller



Wired Remote Controller (CZ-RD516C-1) (Optional)



Wall Mounted Heat Pumps									
Model No.	E9NKUA		E12NKUA		E18NKUA		E24NKUA		Unit Model No.
	Indoor Unit CS-E9NKUAW	Outdoor Unit CU-E9NKUA	Indoor Unit CS-E12NKUAW	Outdoor Unit CU-E12NKUA	Indoor Unit CS-E18NKUA	Outdoor Unit CU-E18NKUA	Indoor Unit CS-E24NKUA	Outdoor Unit CU-E24NKUA	
Performance & Electrical Ratings									
Capacity	Cooling	Btu/h	8,500 (4,100-10,200)	12,000 (4,100-13,300)	17,100 (5,800-19,800)	24,000 (5,800-27,200)			
	Heating	Btu/h	11,200 (4,100-14,100)	13,800 (4,100-16,300)	20,400 (5,800-20,800)	28,800 (5,800-29,200)			
Moisture Removal	High	Pints/H	1.3	2.5	3.0	7.6			
Dry Air Flow	High	CFM	395	425	650	650			
SEER	Cooling		21.0	20.0	18.0	17.5			
EER	Cooling		13.1	12.0	13.2	10.2			
HSPF	Heating		10.5	10.6	8.5	8.5			
Power Supply	V, Phase, Hz		230/208V, 1PH, 60Hz	230/208V, 1PH, 60Hz	230/208V, 1PH, 60Hz	230/208V, 1PH, 60Hz			
Running Amps	Cooling	A	3.1 (-7)	4.7 (-7.8)	6.30 / 7.20	10.80 / 11.90			
	Heating	A	5.4 (-7)	5.8 (-7.8)	7.50 / 8.60	11.40 / 12.60			
Power Input	Cooling	W	650 (250-850)	1,000 (250-1,150)	1,300 (430-1,600)	2,350 (430-2,720)			
	Heating	W	1,150 (200-1,500)	1,300 (200-1,710)	1,600 (380-1,650)	2,500 (380-2,660)			
Back-up Heater		kW	---	---	---	---			
Fuse or Circuit Breaker Capacity		A	15	15	20	20			
Features									
Controls	Microprocessor		Microprocessor		Microprocessor		Microprocessor		
Low Ambient Control	Equipped		Equipped		Equipped		Equipped		
Wireless Controller	Included		Included		Included		Included		
Wired Remote Controller (optional)	CZ-RD516C-1		CZ-RD516C-1		CZ-RD516C-1		CZ-RD516C-1		
Fan Speeds	5 Speeds + Auto		5 Speeds + Auto		5 Speeds + Auto		5 Speeds + Auto		
Timer	24-hr Program		24-hr Program		24-hr Program		24-hr Program		
Air Deflection	Horizontal	Manual		Manual		Automatic		Automatic	
	Vertical	Automatic		Automatic		Automatic		Automatic	
Air Filter	Washable + Anti Microbial Filter		Washable + Anti Microbial Filter		Washable + Anti Microbial Filter		Washable + Anti Microbial Filter		
Refrigerant	R-410A		R-410A		R-410A		R-410A		
Refrigerant control	Electric Expansion Valve		Electric Expansion Valve		Electric Expansion Valve		Electric Expansion Valve		
Operation Sound	In (Hi / Me / Lo / Qt)	dB-A	40 / 25 / 20	43 / 28 / 20	47 / 39 / 36	48 / 40 / 37			
	Outdoor (Hi)	dB-A	47	48	49	51			
Refrigerant Piping	Type	Flare		Flare		Flare		Flare	
	Discharge	inches	1/4"	1/4"	1/4"	1/4"			
	Suction	inches	3/8"	1/2"	1/2"	5/8"			
Refrigerant Pipe Length		Ft.	Max. 66	Max. 66	Max. 100	Max. 100			
Elevation Difference*	Outdoor Above	Ft.	Max. 49	Max. 49	Max. 49	Max. 49			
	Outdoor Below	Ft.	Max. 49	Max. 49	Max. 49	Max. 49			
Dimensions & Weight									
Height	inches	11-7/16"	21-9/32"	11-7/16"	21-9/32"	11-7/16"	31-5/16"	11-7/16"	31-5/16"
Width	inches	34-9/32"	30-23/32"	34-9/32"	30-23/32"	42-5/32"	34-15/32"	42-5/32"	34-15/32"
Depth	inches	8-1/16"	11-13/32"	8-1/16"	11-13/32"	9-9/32"	12-5/8"	9-9/32"	12-5/8"
Net Weight	Lbs.	20.0	82.0	20.0	82.0	26.0	132.0	26.0	132.0

* This is maximum elevation difference when the indoor unit is located above the outdoor unit. (Refer to the table on the P.34 in the catalog for more detail.)

Wall-Mounted Heat Pumps

26PEK1U6



Indoor Unit
S-26PK1U6



Outdoor Unit
U-26PE1U6



Wireless Remote Controller



Wired Remote Controller CZ-RTC2 (Optional)



KE30NKU / KE36NKU



Indoor Unit
CS-KE30NKU / CS-KE36NKU



Outdoor Unit
CU-KE30NKU / CU-KE36NKU



Wireless Remote Controller



Wired Remote Controller CZ-RD515U (Optional)

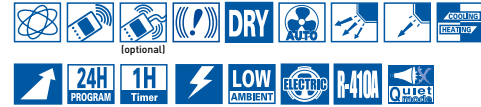

Wall Mounted Heat Pumps

Model No.	26PEK1U6		KE30NKU		KE36NKU		
	Indoor Unit S-26PK1U6	Outdoor Unit U-26PE1U6	Indoor Unit CS-KE30NKU	Outdoor Unit CU-KE30NKU	Indoor Unit CS-KE36NKU	Outdoor Unit CU-KE36NKU	
Performance & Electrical Ratings							
Capacity	Cooling	Btu/h	25,200 (9,500-25,200)	30,600 (10,900-30,600)	34,000 (10,900-34,000)		
	Heating	Btu/h	29,200 (8,000-29,200)	33,000 (14,000-33,000)	36,000 (14,000-36,000)		
Moisture Removal	High	Pints/H	8.1	9.57	10.64		
	Dry Air Flow	Hi / Med / Low	CFM	559 / 475 / 390	630 / 530 / 412	630 / 530 / 412	
SEER	Cooling		14.9	16	16		
EER	Cooling		8.9	9.3	8.5		
HSPF	Heating		10.2	9.0	9.0		
Power Supply	V, Phase, Hz		230V / 208V, 1PH, 60Hz		230 / 208V, 1PH, 60Hz		
Running Amps	Cooling	A	15.3 / 16.9	16.5 (5-16.5) / 18.0	20 (5-20) / 21.9		
	Heating	A	14.0 / 15.5	15.3 (4.5-15.3) / 16.3	18.2 (4.5-18.2) / 19.9		
Power Input	Cooling	W	2,840 / 2,840	3,290	4,000		
	Heating	W	2,620 / 2,620	3,070	3,650		
Back-up Heater		kW	---		---		
Fuse or Circuit Breaker Capacity	A		15	35	45		
Features							
Controls	Microprocessor		Microprocessor		Microprocessor		
Low Ambient Control	Built-in 0°F		Built-in 0°F		Built-in 0°F		
Wireless Remote Controller	Included		Included		Included		
Wired Remote Controller (optional)	CZ-RTC2		CZ-RD515U & CZ-RC515UA		CZ-RD515U & CZ-RC515UA		
Fan Speeds	3 and Automatic Control / Variable		Hi / Me / Lo & Auto		Hi / Me / Lo & Auto		
Timer	24-hr Program		1-hr OFF and 24-hr Program		1-hr OFF and 24-hr Program		
Air Deflection	Horizontal	---		Manual		Manual	
	Vertical	Automatic		Automatic		Automatic	
Air Filter	Washable		Washable		Washable		
Refrigerant	R-410A		R-410A		R-410A		
Refrigerant control	Electric Expansion Valve		Electric Expansion Valve		Electric Expansion Valve		
Operation Sound	In (Hi / Me / Lo / Ot)	dB-A	41 / 37 / 34	49 / 44 / 39	49 / 44 / 39		
	Outdoor (Hi)	dB-A	49	55	55		
Refrigerant Piping	Type		Flare		Flare		
	Discharge	inches	3/8"		3/8"		
	Suction	inches	5/8"		5/8"		
Refrigerant Pipe Length	Ft.	Max. 165	Max. 164		Max. 164		
Elevation Difference*	Outdoor Above	Ft.	Max. 100		Max. 100		
	Outdoor Below	Ft.	Max. 50		Max. 50		
Dimensions & Weight							
Height	inches	Indoor Unit 12-63/64"	Outdoor Unit 30-23/32"	Indoor Unit 11-3/16"	Outdoor Unit 35-13/16"	Indoor Unit 11-3/16"	Outdoor Unit 35-13/16"
Width	inches	44-7/8"	37"	41-15/16"	37-1/32"	41-15/16"	37-1/32"
Depth	inches	8-31/32"	13-3/8"	9-1/16"	13-3/8"	9-1/16"	13-3/8"
Net Weight	Lbs.	40.0	128.0	32.0	185.0	32.0	185.0

* This is maximum elevation difference when the indoor unit is located above the outdoor unit. (Refer to the table on the P.34 in the catalog for more detail.)

KS30NKUA / KS36NKUA



Indoor Unit
CS-KS30NKU / CS-KS36NKU



Outdoor Unit
CU-KS30NKUA /
CU-KS36NKUA



Wireless
Remote
Controller



Wired Remote
Controller
CZ-RD515U
(Optional)



Wall Mounted Air Conditioners						
Model No.		KS30NKUA		KS36NKUA		
Unit Model No.		Indoor Unit	Outdoor Unit	Indoor Unit	Outdoor Unit	
		CS-KS30NKU	CU-KS30NKUA	CS-KS36NKU	CU-KS36NKUA	
Performance & Electrical Ratings						
Capacity	Cooling	Btu/h	30,600 (10,900-30,600)		34,000 (10,900-34,000)	
	Heating	Btu/h	---		---	
Moisture Removal	High	Pints/H	9.57		10.64	
	Hi / Med / Low	CFM	630 / 530 / 412		630 / 530 / 412	
SEER	Cooling		16.0		16.0	
EER	Cooling		9.3		8.5	
HSPF	Heating		---		---	
Power Supply		V, Phase, Hz	230 / 208V, 1PH, 60Hz		230 / 208V, 1PH, 60Hz	
Running Amps	Cooling	A	16.5 / 18		20 / 21.9	
	Heating	A	---		---	
Power Input	Cooling	W	3,290		4,000	
	Heating	W	---		---	
Back-up Heater		kW	---		---	
Fuse or Circuit Breaker Capacity		A	35		45	
Features						
Controls			Microprocessor		Microprocessor	
Low Ambient Control			Built-in 0°F		Built-in 0°F	
Wireless Remote Controller			Included		Included	
Wired Remote Controller (optional)			CZ-RD515U & CZ-RC515UA		CZ-RD515U & CZ-RC515UA	
Fan Speeds			Hi / Me / Lo & Auto		Hi / Me / Lo & Auto	
Timer			1-hr OFF and 24-hr Program		1-hr OFF and 24-hr Program	
Air Deflection	Horizontal		Manual		Manual	
	Vertical		Automatic		Automatic	
Air Filter			Washable		Washable	
Refrigerant			R-410A		R-410A	
Refrigerant control			Electric Expansion Valve		Electric Expansion Valve	
Operation Sound	In (Hi / Me / Lo / Qt)	dB-A	49 / 44 / 39		49 / 44 / 39	
	Outdoor (Hi)	dB-A	55		55	
Refrigerant Piping	Type		Flare		Flare	
	Discharge	inches	3/8"		3/8"	
	Suction	inches	5/8"		5/8"	
Refrigerant Pipe Length		Ft.	Max. 164		Max. 164	
Elevation Difference	Outdoor Above	Ft.	Max. 100		Max. 100	
	Outdoor Below	Ft.	Max. 50		Max. 50	
Dimensions & Weight						
Height		inches	Indoor Unit	Outdoor Unit	Indoor Unit	Outdoor Unit
			11-3/16"	35-13/16"	11-3/16"	35-13/16"
Width		inches	41-15/16"		41-15/16"	
Depth		inches	9-1/16"		13-3/8"	
Net Weight		Lbs.	32		183	

This is maximum elevation difference when the indoor unit is located above the outdoor unit. (Refer to the table on the P.34 in the catalog for more detail.)

Whole House Solutions



RAC Multi-System Indoor Units

E Series

The multi-system type allows a single outdoor unit to be connected to 2 indoor units. It also solves the problem of limited installation space and does not clutter the exterior of your home.



CS-E9RKUAW / CS-E12RKUAW

CS-ME7RKUA



Wireless Remote Controller "Included" with each indoor

Wired Remote Controller (CZ-RD516C-1) (Optional)



RAC Multi System

Indoor Unit: Wall Mounted Type

				Heat Pump		
Model No.	CS-ME7RKUA		CS-E9RKUAW		CS-E12RKUAW	
Power Source	230V / 208V, 1PH, 60Hz					
Running Ampere	2.5 / 2.8		5.1 / 5.7		5.6 / 6.3	
Power Input	W		W		W	
Capacity	Cooling	Btu/h	500 (340-810) 740 (300-1,230)	690 (250-850) 1,120 (200-1,500)	920 (250-1,150) 1,250 (200-1,710)	
	Heating	Btu/h	6,900 (6,100-9,900)	9,000 (4,100-10,200)	11,500 (4,100-13,300)	
Moisture Removal	High	Pints/H	0.8	1.3	1.7	
	Unit Dimensions (H x W x D)	inch	11-7/16" x 34-9/32" x 8-7/16"			
Net Weight	Lbs.	9.0	20.0	20.0		
Air Circulation (High)	Cooling	CFM	390	425	450	
	Heating	CFM	425	455	505	
Operating Sound	Cooling	dB-A	39 / 25	40 / 25 / 20	43 / 28 / 20	
	Heating	dB-A	41 / 29	42 / 29 / 26	44 / 35 / 32	
Refrigerant Tube Diameter	Discharge	inch	1/4"	1/4"	1/4"	
	Suction	inch	3/8"	3/8"	3/8"	
Adapters required	n/a					
Elevation Difference*	Outdoor Above	Ft.	Max. 49	Max. 49.2	Max. 49.2	
	Outdoor Below	Ft.	Max. 49	Max. 49.2	Max. 49.2	

* CZ-MA1P-US (indoor)

* This is maximum elevation difference when the indoor unit is located above the outdoor unit. (Refer to the table on the P.34 in the catalog for more detail.)

RAC Multi-System Outdoor Units

For **2** Rooms



*Blue Fin
Condenser*



CU-2E18NBU

Model No.			CU-2E18NBU	
Performance			Cooling	Heating
Capacity	Btu/h		16,700	20,200
Air Circulation	High	CFM	1,313	
Number of Connectable Indoor Units			2	
SEER	Cooling		18.0	
EER	Cooling		11.5	
HSPF	Heating		8.8	
Electrical Rating				
Power Supply	V, Phase, Hz		230V / 208V, 1PH, 61Hz	
Running Ampere	A		6.9 / 7.6	8.1 / 9.0
Power Input	W		1,450	1,850
Maximum Fuse Size	Amps		25	
Features				
Controls			Microprocessor	
Fan Speeds			Auto	
Compressor			DC Inverter	
Refrigerant / Amount Charged at Shipment			R-410A / 67.80 Oz	
Refrigerant Control			Electric Expansion Valve	
Operation Sound	Hi	dB-A	48	49
Refrigerant Tubing Connections		Type	Flare	
Max. Allowable Tubing Length		Ft.	Max.164 (82"per unit)	
Refrigerant Tube Diameter	Discharge	inch	1/4"	
	Suction	inch	3/8"	
Dimensions & Weight				
Unit Dimensions	H x W x D	inch	31-5/16" x 34-15/32"(+3-3/4) x 12-5/8"	
Net Weight		Lbs.	152	

CU-2E18NBU-Cooling

	Indoor unit combinations	Cooling Capacity(BTU/h)				Input Power (W)		Current, 208V (A)	Current, 230V (A)	Moisture Removal Volume pt/h
		Room A	Room B	Total	min - max	Rating	min - max			
1 Room	CS-ME7RKUA	6,900	---	6,900	6,100 - 9,900	500	340 - 810	2.8	2.5	0.8
	CS-E9RKUAW	9,600	---	9,600	6,200 - 11,200	850	390 - 1,020	4.5	4.1	1.1
	CS-E12RKUAW*	10,900	---	10,900	6,300 - 12,800	1,000	390 - 1,230	5.2	4.7	1.3
2 Room	CS-ME7RKUA + CS-ME7RKUA	6,900	6,900	13,800	6,600 - 16,200	1,050	390 - 1,400	5.5	5.0	0.8 + 0.8
	CS-ME7RKUA + CS-E9RKUAW	6,900	9,600	16,500	7,000 - 19,600	1,500	390 - 1,970	7.8	7.1	0.8 + 1.1
	CS-ME7RKUA + CS-E12RKUAW	6,500	10,200	16,700	7,100 - 20,000	1,500	390 - 1,970	7.8	7.1	0.8 + 1.3
	CS-E9RKUAW / CS-E9RKUAW	8,350	8,350	16,700	7,100 - 20,000	1,450	390 - 1,920	7.6	6.9	1.1 + 1.1
	CS-E9RKUAW / CS-E12RKUAW*	7,800	8,900	16,700	7,200 - 20,000	1,450	390 - 1,870	7.6	6.9	1.1 + 1.3
	CS-E12RKUAW / CS-E12RKUAW*	8,350	8,350	16,700	7,200 - 20,000	1,450	390 - 1,840	7.6	6.9	1.3 + 1.3

CU-2E18NBU-Heating

	Indoor unit combinations	Heating Capacity(BTU/h)				Input Power (W)		Current, 208V (A)	Current, 230V (A)	Moisture Removal Volume pt/h
		Room A	Room B	Total	min - max	Rating	min - max			
1 Room	CS-ME7RKUA	10,900	---	10,900	4,100 - 14,000	740	300 - 1,230	4.1	3.7	---
	CS-E9RKUAW	13,700	---	13,700	6,400 - 15,700	1,150	440 - 1,450	5.9	5.4	---
	CS-E12RKUAW	15,300	---	15,300	6,500 - 17,500	1,300	440 - 1,630	6.6	6.0	---
2 Room	CS-ME7RKUA + CS-ME7RKUA	10,100	10,100	20,200	7,100 - 23,200	1,850	420 - 2,240	9.0	8.1	---
	CS-ME7RKUA + CS-E9RKUAW	8,400	11,800	20,200	7,000 - 23,800	1,850	420 - 2,290	9.0	8.1	---
	CS-ME7RKUA + CS-E12RKUAW	7,700	12,500	20,200	7,100 - 24,200	1,850	420 - 2,310	9.0	8.1	---
	CS-E9RKUAW + CS-E9RKUAW	10,100	10,100	20,200	7,100 - 24,600	1,850	420 - 2,310	9.0	8.1	---
	CS-E9RKUAW + CS-E12RKUAW*	9,400	10,800	20,200	7,200 - 24,600	1,850	420 - 2,290	9.0	8.1	---
	CS-E12RKUAW* + CS-E12RKUAW*	10,100	10,100	20,200	7,200 - 24,600	1,850	420 - 2,290	9.0	8.1	---

* For CS-E12RKUAW, the pipe size reducer CZ-MA1P must be used when connecting with multi-zone outdoor unit.

RAC Multi-System Heat Pump

Advantages of New Multi-Split Inverter System

Connectable from 2 to 5 Indoor units. System 5 allows single outdoor unit to be connected to 2-5 indoor units.

It solves the problem of limited installation space does not clutter the exterior of your home.

Up to **5** Rooms



Indoor Unit: Wall Mounted Type

Model No.			NEW	CS-ME7RKUA	CS-E9RKUAW	CS-E12RKUAW	CS-E18RKUAW	CS-E24RKUAW
Performance & Electrical Ratings								
Capacity	Cooling	Btu/h		6,900 (6,100-9,900)	9,000 (4,100-10,200)	11,500 (4,100-13,300)	17,200 (5,800-19,800)	24,000 (5,800-27,200)
	Heating	Btu/h		10,900 (4,100-14,000)	12,000 (4,100-14,100)	13,800 (4,100-16,300)	21,600 (5,800-22,000)	28,800 (5,800-29,200)
Moisture Removal	High	Pints/H		0.8	1.3	1.7	3.0	7.6
	Dry Air Flow	High	CFM	425	455	505	695	715
Power Supply	V, Phase, Hz			208/230V, 1PH, 60Hz	230/208V, 1PH, 60Hz	230/208V, 1PH, 60Hz	230/208V, 1PH, 60Hz	230/208V, 1PH, 60Hz
Running Amps	Cooling	A		2.5 / 2.8	3.2 / 3.6	4.2 / 4.7	6.3 / 7.0	10.8 / 11.9
	Heating	A		3.7 / 4.1	5.1 / 5.7	5.6 / 6.3	8.3 / 9.3	11.4 / 12.6
Power Input	Cooling	W		500 (340-810)	690 (250-850)	920 (250-1,150)	1,300 (430-1,600)	2,350 (430-2,720)
	Heating	W		740 (300-1,230)	1,120 (300-1,230)	1,250 (200-1,710)	1,750 (380-1,800)	2,500 (380-2,660)
Operation Sound [Hi / Me / Lo / O-Lo]	Cooling			39 / 25	40 / 25 / 20	43 / 28 / 20	47 / 39 / 36	48 / 40 / 37
	Heating			41 / 29	42 / 29 / 26	44 / 35 / 32	46 / 39 / 36	48 / 40 / 37
Elevation Difference*	Outdoor Above	ft		Max. 49	Max. 49.2	Max. 49.2	Max. 49.2	Max. 49.2
	Outdoor Below	ft		Max. 49	Max. 49.2	Max. 49.2	Max. 49.2	Max. 49.2
Refrigerant Tube Diameter	Discharge	inches		1/4"	1/4"	1/4"	1/4"	1/4"
	Suction	inches		3/8"	3/8"	3/8"	1/2"	5/8"
Adapters Required				n/a	n/a	n/a	n/a	n/a
Dimensions & Weight								
Height		inches		11-7/16"	11-7/16"	11-7/16"	11-7/16"	11-7/16"
Width		inches		34-9/32"	34-9/32"	34-9/32"	42-5/32"	42-5/32"
Depth		inches		8-7/16"	8-7/16"	8-7/16"	9-15/32"	9-15/32"
Net Weight		lb		9.0	20.0	20.0	26.0	26.0

Caution: All field installed tubing must be compliant to refrigerant 410a.

* A minimum of 2 indoor units must be connected.

* This is maximum elevation difference when the indoor unit is located above the outdoor unit. (Refer to the table on the back of the catalog)

RAC Multi-System Heat Pump

CS-ME7RKUA / CS-E9RKUAW / CS-E12RKUAW



CS-E18RKUAW / CS-E24RKUAW



INVERTER
Blue Fin
Condenser



Wireless Remote Controller (Standard)



Wired Remote Controller CZ-RD516-1 (Optional)



Tubing Length

Outdoor Tube Size	Narrow	Inches	1/4"
	Wide	Inches	3/8"
Maximum length of tubing between In / Outdoor		ft	82/unit (262 total)
Maximum Elevation difference between In / Outdoor	Above	ft	49
	Below	ft	25
Maximum Length (ft) of Tubing at shipment (System)*		ft	150
Required Additional Refrigerant		Oz/ft	R410a 0.2
Insulation			Both tubes

* It is possible to have a combination of wall-mounted models (CS-ME7QKUA, CS-E9NKUAW, E12NKUAW, CS-E18NKUA, E24NKUA) for the (CU-5E36QBU).
* A minimum of 2 indoor units must be connected.
* No additional refrigerant needed up to 138 ft. of combined tubing.

Specifications

Model No.	CU-5E36QBU		
Performance	Cooling		Heating
Capacity	Rated (min-max)	Btu/h	
Air Circulation	High	CFM	
Number of Connectable Indoor Units			
SEER	Cooling		
EER	Cooling		
HSPF	Heating		
Electrical Rating			
Power Supply	V, Phase, Hz	230V / 208V, 1Ph, 60Hz	
Running Amperage	A	17.2 / 19.0	13.4 / 14.8
Power Input	W	3,750 (550-3,860)	2,900 (530-4,240)
Maximum Fuse Size	Amps	45A	
Features			
Controls	Microprocessor		
Compressor	DC Inverter		
Refrigerant / Amount Charged at Shipment	Type/oz	R-410A / 120.0 oz	
Refrigerant Control	Electric Expansion Valve		
Operation Sound	Hi	dB-A	55
Refrigerant Tubing Connections	Type	Flare	
Max. Allowable Tubing Length	ft	82 (per Unit) 262 (per System) with additional refrigerant	
Refrigerant Tube Diameter	Discharge	inches	1/4" x 5
	Suction	inches	3/8" x 5
Adapters Required	CZ-MA2P - Outdoor Unit (When connected to CS-24NKUA)		
Dimensions & Weight			
Unit Dimensions	H x W x D	inches 39-11/32" x 37-1/32" x 13-13/32"	
Net Weight	lb	183	

* Test condition based on AHRI 210/240
* When pipes are not extended from the chargeless pipe length, the required amount of refrigerant is already in the unit.
* Use CZ-MA2P when connecting with CS-E24NKUA (3/8" to 1/2")

RAC Multi-Combination Tables Heat Pump

CU-5KE36QBU 230V

	Indoor Unit Combination		Indoor Unit Capacity (BTU/h)												
			COOLING						HEATING						
			Room A	Room B	Room C	Room D	Room E	Total Performance			Room A	Room B	Room C	Room D	Room E
			Capacity (Min. - Max.)			Capacity (Min. - Max.)			Capacity (Min. - Max.)						
2-room Operation	6,900 + 8,600	= 15,500	6,844	8,556				15,400 (9,900 - 19,800)	9,244	11,556					20,800 (8,200 - 28,000)
	6,900 + 10,900	= 17,800	6,846	10,954				17,800 (9,900 - 19,800)	9,077	14,523					23,600 (8,200 - 29,400)
	6,900 + 17,100	= 24,000	6,857	17,143				24,000 (9,900 - 28,000)	8,743	21,857					30,600 (8,200 - 37,600)
	6,900 + 24,000	= 30,900	6,844	23,956				30,800 (9,900 - 35,400)	8,089	28,311					36,400 (8,900 - 44,500)
	8,600 + 8,600	= 17,200	8,600	8,600				17,200 (9,900 - 19,800)	11,100	11,100					22,200 (8,200 - 29,400)
	8,600 + 10,900	= 19,500	8,553	10,947				19,500 (9,900 - 22,800)	10,877	13,923					24,800 (8,200 - 34,400)
	8,600 + 17,100	= 25,700	8,533	17,067				25,600 (9,900 - 30,000)	10,667	21,333					32,000 (8,200 - 37,600)
	8,600 + 24,000	= 32,600	8,579	24,021				32,600 (9,900 - 36,200)	9,947	27,853					37,800 (8,900 - 44,500)
	10,900 + 10,900	= 21,800	10,900	10,900				21,800 (9,900 - 24,600)	13,800	13,800					27,600 (8,200 - 37,600)
	10,900 + 17,100	= 28,000	10,927	17,073				28,000 (9,900 - 32,000)	13,580	21,220					34,800 (8,200 - 40,500)
	10,900 + 24,000	= 34,900	10,918	23,882				34,800 (9,900 - 37,600)	11,859	25,941					37,800 (8,900 - 47,000)
	17,100 + 17,100	= 34,200	17,100	17,100				34,200 (9,900 - 37,600)	18,900	18,900					37,800 (8,200 - 47,000)
	17,100 + 24,000	= 41,100	15,000	21,000				36,000 (9,900 - 37,600)	15,750	22,050					37,800 (8,900 - 47,000)
	24,000 + 24,000	= 48,000	18,000	18,000				36,000 (9,900 - 37,600)	18,900	18,900					37,800 (9,500 - 47,000)
3-room Operation	6,900 + 6,900 + 6,900	= 20,700	6,867	6,867	6,867			20,600 (9,900 - 27,600)	9,867	9,867	9,867				29,600 (11,600 - 42,000)
	6,900 + 6,900 + 8,600	= 22,400	6,892	6,892	8,616			22,400 (9,900 - 27,600)	9,415	9,415	11,770				30,600 (11,600 - 42,000)
	6,900 + 6,900 + 10,900	= 24,700	6,833	6,833	10,934			24,600 (9,900 - 27,600)	9,278	9,278	14,844				33,400 (11,600 - 42,000)
	6,900 + 6,900 + 17,100	= 30,900	6,844	6,844	17,112			30,800 (9,900 - 33,800)	8,400	8,400	21,000				37,800 (11,600 - 46,500)
	6,900 + 6,900 + 24,000	= 37,800	6,545	6,545	22,910			36,000 (9,900 - 38,000)	6,873	6,873	24,054				37,800 (11,600 - 47,000)
	6,900 + 8,600 + 8,600	= 24,100	6,858	8,571	8,571			24,000 (9,900 - 27,600)	9,142	11,429	11,429				32,000 (11,600 - 42,000)
	6,900 + 8,600 + 10,900	= 26,400	6,857	8,571	10,972			26,400 (9,900 - 27,600)	9,039	11,299	14,462				34,800 (11,600 - 44,000)
	6,900 + 8,600 + 17,100	= 32,600	6,863	8,579	17,158			32,600 (9,900 - 35,800)	7,958	9,947	19,895				37,800 (11,600 - 46,500)
	6,900 + 8,600 + 24,000	= 39,500	6,261	7,826	21,913			36,000 (9,900 - 38,000)	6,574	8,217	23,009				37,800 (11,600 - 47,000)
	6,900 + 10,900 + 10,900	= 28,700	6,858	10,971	10,971			28,800 (9,900 - 31,400)	8,952	14,324	14,324				37,600 (11,600 - 44,000)
	6,900 + 10,900 + 17,100	= 34,900	6,823	10,918	17,059			34,800 (9,900 - 38,000)	7,412	11,859	18,529				37,800 (11,600 - 46,500)
	6,900 + 10,900 + 24,000	= 41,800	5,901	9,443	20,656			36,000 (9,900 - 38,000)	6,196	9,915	21,689				37,800 (11,600 - 47,000)
	6,900 + 17,100 + 17,100	= 41,100	6,000	15,000	15,000			36,000 (9,900 - 38,000)	6,300	15,750	15,750				37,800 (11,600 - 47,000)
	6,900 + 17,100 + 24,000	= 48,000	5,143	12,857	18,000			36,000 (9,900 - 38,000)	5,400	13,500	18,900				37,800 (11,600 - 48,000)
	6,900 + 24,000 + 24,000	= 54,900	4,500	15,750	15,750			36,000 (9,900 - 38,000)	4,724	16,538	16,538				37,800 (11,600 - 49,000)
	8,600 + 8,600 + 8,600	= 25,800	8,600	8,600	8,600			25,800 (9,900 - 27,600)	11,000	11,000	11,000				33,000 (11,600 - 42,000)
	8,600 + 8,600 + 10,900	= 28,100	8,598	8,598	11,004			28,200 (9,900 - 31,400)	10,915	10,915	13,970				35,800 (11,600 - 44,000)
	8,600 + 8,600 + 17,100	= 34,300	8,550	8,550	17,100			34,200 (9,900 - 38,000)	9,450	9,450	18,900				37,800 (11,600 - 46,500)
	8,600 + 8,600 + 24,000	= 41,200	7,500	7,500	21,000			36,000 (9,900 - 38,000)	7,875	7,875	22,050				37,800 (11,600 - 47,000)
	8,600 + 10,900 + 10,900	= 30,400	8,540	10,930	10,930			30,400 (9,900 - 33,800)	10,618	13,591	13,591				37,800 (11,600 - 46,500)
	8,600 + 10,900 + 17,100	= 36,600	8,411	10,766	16,823			36,000 (9,900 - 38,000)	8,831	11,305	17,664				37,800 (11,600 - 47,000)
	8,600 + 10,900 + 24,000	= 43,500	7,086	9,071	19,843			36,000 (9,900 - 38,000)	7,441	9,524	20,835				37,800 (11,600 - 48,000)
	8,600 + 17,100 + 17,100	= 42,800	7,200	14,400	14,400			36,000 (9,900 - 38,000)	7,560	15,120	15,120				37,800 (11,600 - 47,000)
	8,600 + 17,100 + 24,000	= 49,700	6,207	12,414	17,379			36,000 (9,900 - 38,000)	6,517	13,034	18,249				37,800 (11,600 - 48,000)
	8,600 + 24,000 + 24,000	= 56,600	5,454	15,273	15,273			36,000 (9,900 - 38,000)	5,728	16,036	16,036				37,800 (11,600 - 49,000)
	10,900 + 10,900 + 10,900	= 32,700	10,933	10,933	10,933			32,800 (9,900 - 35,800)	12,600	12,600	12,600				37,800 (11,600 - 46,500)
	10,900 + 10,900 + 17,100	= 38,900	10,105	10,105	15,790			36,000 (9,900 - 38,000)	10,611	10,611	16,578				37,800 (11,600 - 47,000)
	10,900 + 10,900 + 24,000	= 45,800	8,597	8,597	18,806			36,000 (9,900 - 38,000)	9,027	9,027	19,746				37,800 (11,600 - 48,000)
	10,900 + 17,100 + 17,100	= 45,100	8,728	13,636	13,636			36,000 (9,900 - 38,000)	9,164	14,318	14,318				37,800 (11,600 - 48,000)
	10,900 + 17,100 + 24,000	= 52,000	7,579	11,842	16,579			36,000 (9,900 - 38,000)	7,958	12,434	17,408				37,800 (11,600 - 49,000)
	10,900 + 24,000 + 24,000	= 58,900	6,698	14,651	14,651			36,000 (9,900 - 38,000)	7,032	15,384	15,384				37,800 (11,600 - 49,000)
	17,100 + 17,100 + 17,100	= 51,300	12,000	12,000	12,000			36,000 (9,900 - 38,000)	12,600	12,600	12,600				37,800 (11,600 - 49,000)
	17,100 + 17,100 + 24,000	= 58,200	10,588	10,588	14,824			36,000 (9,900 - 38,000)	11,118	11,118	15,564				37,800 (11,600 - 49,000)
	4-room Operation	6,900 + 6,900 + 6,900 + 6,900	= 27,600	6,850	6,850	6,850	6,850		27,400 (9,900 - 36,400)	9,450	9,450	9,450	9,450		
6,900 + 6,900 + 6,900 + 8,600		= 29,300	6,871	6,871	6,871	8,587		29,200 (9,900 - 36,400)	8,894	8,894	8,894	11,118			37,800 (11,600 - 48,500)
6,900 + 6,900 + 6,900 + 10,900		= 31,600	6,870	6,870	6,870	10,990		31,600 (9,900 - 36,400)	8,217	8,217	8,217	13,149			37,800 (11,600 - 48,500)
6,900 + 6,900 + 6,900 + 17,100		= 37,800	6,545	6,545	6,545	16,365		36,000 (9,900 - 36,400)	6,873	6,873	6,873	17,181			37,800 (11,600 - 48,500)
6,900 + 6,900 + 6,900 + 24,000		= 44,700	5,538	5,538	5,538	19,386		36,000 (9,900 - 37,600)	5,815	5,815	5,815	20,355			37,800 (11,600 - 49,000)
6,900 + 6,900 + 8,600 + 8,600		= 31,000	6,844	6,844	8,556	8,556		30,800 (9,900 - 36,400)	8,400	8,400	10,500	10,500			37,800 (11,600 - 48,500)
6,900 + 6,900 + 8,600 + 10,900		= 33,300	6,845	6,845	8,557	10,953		33,200 (9,900 - 36,400)	7,794	7,794	9,742	12,470			37,800 (11,600 - 48,500)
6,900 + 6,900 + 8,600 + 17,100		= 39,500	6,261	6,261	7,826	15,652		36,000 (9,900 - 36,400)	6,574	6,574	8,217	16,435			37,800 (11,600 - 48,500)
6,900 + 6,900 + 8,600 + 24,000		= 46,400	5,333	5,333	6,667	18,667		36,000 (9,900 - 37,600)	5,600	5,600	7,000	19,600			37,800 (11,600 - 49,000)
6,900 + 6,900 + 10,900 + 10,900		= 35,600	6,846	6,846	10,954	10,954		35,600 (9,900 - 36,400)	7,269	7,269	11,631	11,631			37,800 (11,600 - 48,500)
6,900 + 6,900 + 10,900 + 17,100		= 41,800	5,902	5,902	9,442	14,754		36,000 (9,900 - 37,600)	6,197	6,197	9,914	15,492			37,800 (11,600 - 48,500)
6,900 + 6,900 + 10,900 + 24,000		= 48,700	5,070	5,070	8,113	17,747		36,000 (9,900 - 37,600)	5,324	5,324	8,518	18,634			37,800 (11,600 - 49,000)
6,900 + 6,900 + 17,100 + 17,100		= 48,000	5,143	5,143	12,857	12,857		36,000 (9,900 - 37,600)	5,400	5,400	13,500	13,500			37,800 (11,600 - 49,000)
6,900 + 6,900 + 17,100 + 24,000		= 54,900	4,500	4,500	11,250	15,750		36,000 (9,900 - 39,000)							

	Indoor Unit Combination		Indoor Unit Capacity (BTU/h)																
			COOLING					HEATING					Total Performance						
			Room A	Room B	Room C	Room D	Room E	Room A	Room B	Room C	Room D	Room E	Total Performance						
													Capacity	(Min.)	(Max.)	Capacity	(Min.)	(Max.)	
4-room Operation	6,900 + 10,900 + 10,900 + 24,000	= 52,700	4,674	7,481	7,481	16,364					36,000	(9,900 - 137,600)	4,908	7,855	7,855	17,182		37,800	(11,600 - 49,000)
	6,900 + 10,900 + 17,100 + 17,100	= 52,000	4,737	7,579	11,842	11,842					36,000	(9,900 - 37,600)	4,974	7,958	12,434	12,434		37,800	(11,600 - 49,000)
	6,900 + 10,900 + 17,100 + 24,000	= 58,900	4,186	6,698	10,465	14,651					36,000	(9,900 - 39,000)	4,395	7,033	10,988	15,384		37,800	(11,600 - 49,000)
	6,900 + 17,100 + 17,100 + 17,100	= 58,200	4,236	10,588	10,588	10,588					36,000	(9,900 - 39,000)	4,446	11,118	11,118	11,118		37,800	(11,600 - 49,000)
	8,600 + 8,600 + 8,600 + 8,600	= 34,400	8,600	8,600	8,600	8,600					34,400	(9,900 - 36,400)	9,450	9,450	9,450	9,450		37,800	(11,600 - 48,500)
	8,600 + 8,600 + 8,600 + 10,900	= 36,700	8,411	8,411	8,411	10,767					36,000	(9,900 - 36,400)	8,832	8,832	8,832	11,304		37,800	(11,600 - 48,500)
	8,600 + 8,600 + 8,600 + 17,100	= 42,900	7,200	7,200	7,200	14,400					36,000	(9,900 - 37,600)	7,560	7,560	7,560	15,120		37,800	(11,600 - 48,500)
	8,600 + 8,600 + 8,600 + 24,000	= 49,800	6,207	6,207	6,207	17,379					36,000	(9,900 - 37,600)	6,517	6,517	6,517	18,249		37,800	(11,600 - 49,000)
	8,600 + 8,600 + 10,900 + 10,900	= 39,000	7,895	7,895	10,105	10,105					36,000	(9,900 - 36,400)	8,289	8,289	10,611	10,611		37,800	(11,600 - 48,500)
	8,600 + 8,600 + 10,900 + 17,100	= 45,200	6,818	6,818	8,727	13,637					36,000	(9,900 - 37,600)	7,159	7,159	9,164	14,318		37,800	(11,600 - 49,000)
	8,600 + 8,600 + 10,900 + 24,000	= 52,100	5,921	5,921	7,579	16,579					36,000	(9,900 - 37,600)	6,217	6,217	7,958	17,408		37,800	(11,600 - 49,000)
	8,600 + 8,600 + 17,100 + 17,100	= 51,400	6,000	6,000	12,000	12,000					36,000	(9,900 - 37,600)	6,300	6,300	12,600	12,600		37,800	(11,600 - 49,000)
	8,600 + 8,600 + 17,100 + 24,000	= 58,300	5,294	5,294	10,588	14,824					36,000	(9,900 - 39,000)	5,559	5,559	11,117	15,565		37,800	(11,600 - 49,000)
	8,600 + 10,900 + 10,900 + 10,900	= 41,300	7,437	9,521	9,521	9,521					36,000	(9,900 - 37,600)	7,809	9,997	9,997	9,997		37,800	(11,600 - 48,500)
	8,600 + 10,900 + 10,900 + 17,100	= 47,500	6,474	8,288	8,288	12,950					36,000	(9,900 - 37,600)	6,799	8,702	8,702	13,597		37,800	(11,600 - 49,000)
	8,600 + 10,900 + 10,900 + 24,000	= 54,400	5,660	7,245	7,245	15,850					36,000	(9,900 - 39,000)	5,942	7,608	7,608	16,642		37,800	(11,600 - 49,000)
	8,600 + 10,900 + 17,100 + 17,100	= 53,700	5,732	7,338	11,465	11,465					36,000	(9,900 - 37,600)	6,019	7,705	12,038	12,038		37,800	(11,600 - 49,000)
	8,600 + 17,100 + 17,100 + 17,100	= 59,900	5,142	10,286	10,286	10,286					36,000	(9,900 - 39,000)	5,400	10,800	10,800	10,800		37,800	(11,600 - 49,000)
	10,900 + 10,900 + 10,900 + 10,900	= 43,600	9,000	9,000	9,000	9,000					36,000	(9,900 - 37,600)	9,450	9,450	9,450	9,450		37,800	(11,600 - 49,000)
	10,900 + 10,900 + 10,900 + 17,100	= 49,800	7,890	7,890	7,890	12,330					36,000	(9,900 - 37,600)	8,285	8,285	8,285	12,945		37,800	(11,600 - 49,000)
10,900 + 10,900 + 10,900 + 24,000	= 56,700	6,940	6,940	6,940	15,180					36,000	(9,900 - 39,000)	7,287	7,287	7,287	15,939		37,800	(11,600 - 49,000)	
10,900 + 10,900 + 17,100 + 17,100	= 56,000	7,024	7,024	10,976	10,976					36,000	(9,900 - 39,000)	7,376	7,376	11,524	11,524		37,800	(11,600 - 49,000)	
5-room Operation	6,900 + 6,900 + 6,900 + 6,900 + 6,900	= 34,500	6,840	6,840	6,840	6,840	6,840				34,200	(9,900 - 39,000)	7,560	7,560	7,560	7,560		37,800	(11,600 - 49,500)
	6,900 + 6,900 + 6,900 + 6,900 + 8,600	= 36,200	6,857	6,857	6,857	6,857	8,572				36,000	(9,900 - 39,000)	7,200	7,200	7,200	7,200	9,000	37,800	(11,600 - 49,500)
	6,900 + 6,900 + 6,900 + 6,900 + 10,900	= 38,500	6,429	6,429	6,429	6,429	10,284				36,000	(9,900 - 39,000)	6,750	6,750	6,750	10,800		37,800	(11,600 - 49,500)
	6,900 + 6,900 + 6,900 + 6,900 + 17,100	= 44,700	5,538	5,538	5,538	5,538	13,848				36,000	(9,900 - 39,000)	5,815	5,815	5,815	14,540		37,800	(11,600 - 49,500)
	6,900 + 6,900 + 6,900 + 8,600 + 8,600	= 37,900	6,545	6,545	6,545	8,182	8,182				36,000	(9,900 - 39,000)	6,873	6,873	6,873	8,591	8,591	37,800	(11,600 - 49,500)
	6,900 + 6,900 + 6,900 + 8,600 + 10,900	= 40,200	6,154	6,154	6,154	7,692	9,846				36,000	(9,900 - 39,000)	6,462	6,462	6,462	8,076	10,338	37,800	(11,600 - 49,500)
	6,900 + 6,900 + 6,900 + 8,600 + 17,100	= 46,400	5,333	5,333	5,333	6,667	13,334				36,000	(9,900 - 39,000)	5,600	5,600	5,600	7,000	14,000	37,800	(11,600 - 49,500)
	6,900 + 6,900 + 6,900 + 8,600 + 24,000	= 53,300	4,645	4,645	4,645	5,806	16,259				36,000	(9,900 - 39,000)	4,877	4,877	4,877	6,097	17,072	37,800	(11,600 - 49,500)
	6,900 + 6,900 + 6,900 + 10,900 + 10,900	= 42,500	5,806	5,806	5,806	9,291	9,291				36,000	(9,900 - 39,000)	6,097	6,097	6,097	9,755	9,755	37,800	(11,600 - 49,500)
	6,900 + 6,900 + 6,900 + 10,900 + 17,100	= 48,700	5,070	5,070	5,070	8,123	12,677				36,000	(9,900 - 39,000)	5,324	5,324	5,324	8,518	13,310	37,800	(11,600 - 49,500)
	6,900 + 6,900 + 6,900 + 10,900 + 24,000	= 55,600	4,444	4,444	4,444	7,111	15,557				36,000	(9,900 - 39,000)	4,667	4,667	4,667	7,466	16,333	37,800	(11,600 - 49,500)
	6,900 + 6,900 + 6,900 + 17,100 + 17,100	= 54,900	4,500	4,500	4,500	11,250	11,250				36,000	(9,900 - 39,000)	4,725	4,725	4,725	11,813	11,813	37,800	(11,600 - 49,500)
	6,900 + 6,900 + 8,600 + 8,600 + 8,600	= 39,600	6,261	6,261	7,826	7,826	7,826				36,000	(9,900 - 39,000)	6,574	6,574	8,217	8,217	8,217	37,800	(11,600 - 49,500)
	6,900 + 6,900 + 8,600 + 8,600 + 10,900	= 41,900	5,902	5,902	7,377	7,377	9,442				36,000	(9,900 - 39,000)	6,197	6,197	7,746	7,746	9,914	37,800	(11,600 - 49,500)
	6,900 + 6,900 + 8,600 + 8,600 + 17,100	= 48,100	5,143	5,143	6,429	6,429	12,856				36,000	(9,900 - 39,000)	5,400	5,400	6,750	6,750	13,500	37,800	(11,600 - 49,500)
	6,900 + 6,900 + 8,600 + 8,600 + 24,000	= 55,000	4,500	4,500	5,625	5,625	15,750				36,000	(9,900 - 39,000)	4,725	4,725	5,906	5,906	16,538	37,800	(11,600 - 49,500)
	6,900 + 6,900 + 8,600 + 10,900 + 10,900	= 44,200	5,581	5,581	6,978	6,978	8,930				36,000	(9,900 - 39,000)	5,860	5,860	7,326	9,377	9,377	37,800	(11,600 - 49,500)
	6,900 + 6,900 + 8,600 + 10,900 + 17,100	= 50,400	4,898	4,898	6,122	7,837	12,245				36,000	(9,900 - 39,000)	5,143	5,143	6,428	8,229	12,857	37,800	(11,600 - 49,500)
	6,900 + 6,900 + 8,600 + 10,900 + 24,000	= 57,300	4,311	4,311	5,389	6,898	15,091				36,000	(9,900 - 39,000)	4,527	4,527	5,659	7,243	15,844	37,800	(11,600 - 49,500)
	6,900 + 6,900 + 8,600 + 17,100 + 17,100	= 56,600	4,364	4,364	5,454	10,909	10,909				36,000	(9,900 - 39,000)	4,582	4,582	5,726	11,455	11,455	37,800	(11,600 - 49,500)
	6,900 + 6,900 + 10,900 + 10,900 + 10,900	= 46,500	5,294	5,294	8,471	8,471	11,471				36,000	(9,900 - 39,000)	5,559	5,559	8,894	8,894	8,894	37,800	(11,600 - 49,500)
	6,900 + 6,900 + 10,900 + 10,900 + 17,100	= 52,700	4,675	4,675	7,481	7,481	11,688				36,000	(9,900 - 39,000)	4,909	4,909	7,855	7,855	12,272	37,800	(11,600 - 49,500)
	6,900 + 6,900 + 10,900 + 10,900 + 24,000	= 59,600	4,138	4,138	6,621	6,621	14,482				36,000	(9,900 - 39,000)	4,345	4,345	6,952	6,952	15,206	37,800	(11,600 - 49,500)
	6,900 + 6,900 + 10,900 + 17,100 + 17,100	= 58,900	4,186	4,186	6,698	10,465	10,465				36,000	(9,900 - 39,000)	4,395	4,395	7,034	10,988	10,988	37,800	(11,600 - 49,500)
	6,900 + 8,600 + 8,600 + 8,600 + 8,600	= 41,300	6,000	7,500	7,500	7,500	7,500				36,000	(9,900 - 39,000)	6,300	7,875	7,875	7,875	7,875	37,800	(11,600 - 49,500)
	6,900 + 8,600 + 8,600 + 8,600 + 10,900	= 43,600	5,668	7,087	7,087	7,087	9,071				36,000	(9,900 - 39,000)	5,953	7,441	7,441	7,441	9,524	37,800	(11,600 - 49,500)
	6,900 + 8,600 + 8,600 + 8,600 + 17,100	= 49,800	4,965	6,207	6,207	6,207	12,414				36,000	(9,900 - 39,000)	5,214						

Fits with Various Sizes of Rooms and Lifestyle

The multi-system type allows a single outdoor unit to be connected to 2 to 4 indoor units. It also solves the problem of limited installation space and does not clutter the exterior of your home.



CS-MKE7NKU / CS-MKE9NKU / CS-MKE12NKU

CS-MKE18NKU / CS-MKE24NKU



Wireless Remote Controller (Included) with each indoor



Wired Remote Controller CZ-RD515U (Optional)



Indoor Unit: Wall Mounted Type

Model No.	Heat Pump					
	CS-MKE7NKU	CS-MKE9NKU	CS-MKE12NKU	CS-MKE18NKU	CS-MKE24NKU	
Power Source	A					
Running Ampere	W					
Power Input	230V-208V, 1 PH, 60 Hz					
Capacity	Cooling Btu/h	7,500	9,000	11,900	17,500	24,200
	Heating Btu/h	8,500	12,200	14,300	20,400	29,000
Moisture Removal	High Pints/H	2.77	3.40	4.26	4.89	4.89
Unit Dimensions (H x W x D)	11"-7/32" x 32"-15/32" x 7"-7/16"			11"-23/32" x 41"-15/16" x 8"-19/32"		
Net Weight	Lbs.	19.8	19.8	19.8	26.5	26.5
Air Circulation (H.M.L)	Cooling CFM	241 / 224 / 212	259 / 249 / 212	282 / 257 / 218	500 / 447 / 377	541 / 500 / 435
	Heating CFM	271 / 241 / 218	282 / 271 / 218	294 / 271 / 218	500 / 447 / 377	541 / 481 / 435
Hi / Me / Lo / Qt	Cooling dB-A	33 / 30 / 27 / 23	34 / 31 / 28 / 23	36 / 33 / 29 / 25	41 / 38 / 34 / 28	44 / 41 / 38 / 30
Operating Sound	Heating dB-A	33 / 30 / 27 / 23	34 / 31 / 28 / 23	34 / 31 / 29 / 25	40 / 37 / 34 / 28	43 / 40 / 37 / 30
Refrigerant Tube Diameter	Discharge inch	1/4"	1/4"	1/4"	1/4"	1/4"
	Suction inch	3/8"	3/8"	3/8"	1/2"	5/8"
Elevation Difference*	Outdoor Above Ft.	Max. 50	Max. 50	Max. 50	Max. 50	Max. 50
	Outdoor Below Ft.	Max. 50	Max. 50	Max. 50	Max. 50	Max. 50

* This is maximum elevation difference when the indoor unit is located above the outdoor unit. (Refer to the table on the back of the catalog)

Fits with Various Sizes of Rooms and Lifestyle

The multi-system type allows a single outdoor unit to be connected to 2 to 4 indoor units. It also solves the problem of limited installation space and does not clutter the exterior of your home.



CS-MKE9NB4U / CS-MKE12NB4U / CS-KE18NB4UW



Wireless Remote Controller (Included) with each indoor



Wired Remote Controller CZ-RD515U Wire Kit CZ-RC515U (Optional)

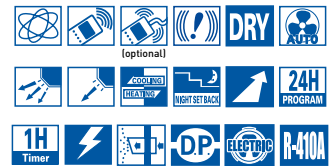

Indoor Unit: Ceiling Recessed Type

		Heat Pump			
Model No.		CS-MKE9NB4U	CS-MKE12NB4U	CS-KE18NB4UW	
Grille Assemblie		CZ-18BT1U			
Power Source		230V-208V, 1 PH, 60 Hz			
Running Ampere	A	0.10 / 0.11 & 0.12 / 0.13	0.11 / 0.12 & 0.13 / 0.14	0.15 / 0.16 & 0.19 / 0.20	
Power Input	W	16 / 18	17 / 19	22 / 27	
Capacity	Cooling	Btu/h	9,000	11,900	17,500
	Heating	Btu/h	12,300	13,600	20,400
Moisture Removal	High	Pints/H	3.4	4.26	4.89
Unit Dimensions (H x W x D)	inch	12.5"-16" x 24"-19/32" x 24"-19/32"			
Net Weight	Lbs	41.3			
Air Circulation (H.M.L)	Cooling	CFM	221 / 206 / 194	235 / 206 / 194	341 / 294 / 253
	Heating	CFM	247 / 235 / 224	268 / 247 / 224	383 / 324 / 265
Operating Sound (H/L)	Cooling	dB-A	33 / 32 / 31	34 / 32 / 31	44 / 40 / 36
	Heating	dB-A	34 / 33 / 32	35 / 34 / 32	44 / 40 / 36
Refrigerant Tube Diameter	Discharge	inch	1/4"	1/4"	1/4"
	Suction	inch	3/8"	3/8"	1/2"
Elevation Difference*	Outdoor Above	Ft.	Max. 50	Max. 50	Max. 50
	Outdoor Below	Ft.	Max. 50	Max. 50	Max. 50

* This is maximum elevation difference when the indoor unit is located above the outdoor unit. (Refer to the table on the back of the catalog)

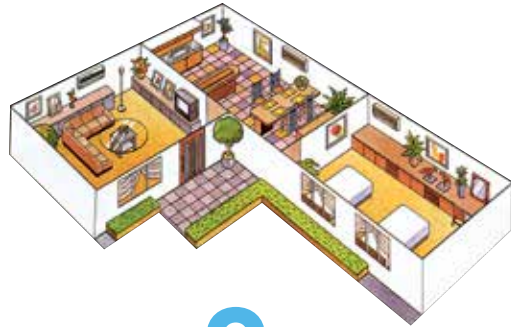

Up to **3** Rooms

Connectable from 2 to 3 Indoor Units



CU-3KE19NBU

Outdoor Unit

Model No.	CU-3KE19NBU		
Performance	Cooling		Heating
Capacity	17,000 Btu/h		23,200
Air Circulation	High	CFM	1,707
Number of Connectable Indoor Units			2-3
SEER	Cooling		18.0
EER	Cooling		12.0
HSPF	Heating		8.8
Electrical Rating			
Power Supply	V, Phase, Hz	230V / 208V, 1Ph, 60Hz	
Running Ampere	A	6.3 / 7.0	9.1 / 10.1
Power Input	W	1,420	2,050
Maximum Fuse Size	Amps	15A	
Features			
Controls	Microprocessor		
Fan Speeds	Auto (Hi, Me, Lo)		
Compressor	DC Inverter		
Refrigerant / Amount Charged at Shipment	R-410A / 6.17		
Refrigerant Control	Electric Expansion Valve		
Operation Sound	Hi	dB-A	50
Refrigerant Tubing Connections	Type	Flare	
Max. Allowable Tubing Length	82 (per Unit) 150 (per System) with additional refrigerant		
Refrigerant Tube Diameter	Discharge	inch	1/4" x 3
	Suction	inch	3/8" x 3
Dimensions & Weight			
Unit Dimensions	H x W x D	inch 29-1/8" x 35-7/16" x 12-19/32"	
Net Weight	Lbs.	143.0	

IMPORTANT It is not possible to connect an outdoor unit to only a single indoor unit. If operated with only ONE indoor unit installed, the returning refrigerant to the compressor may cause a malfunction.

* Test Conditions based on AHRI 210/240

RAC Multi-System Outdoor Units

KE Series



Up to **4** Rooms

Connectable from 2 to 4 Indoor Units



CU-4KE24NBU



CU-4KE31NBU

Outdoor Unit

Model No.	CU-4KE24NBU				CU-4KE31NBU			
	Performance		Cooling	Heating	Performance		Cooling	Heating
Capacity	Btu/h	22,400	1,707	29,000 / 28,600	1,942		30,600	
Air Circulation	High CFM							
Number of Connectable Indoor Units		2-4		2-4				
SEER	Cooling	18.0		17.2				
EER	Cooling	11.5		11.2				
HSPF	Heating	8.5		9.3				
Electrical Rating								
Power Supply	V, Phase, Hz	230V / 208V, 1Ph, 60Hz				230V / 208V, 1Ph, 60Hz		
Running Ampere	A	8.7 / 9.6	10.0 / 11.0	11.4 / 12.6		10.1 / 11.2		
Power Input	W	1,950	2,250	2,600 / 2,560		2,300		
Maximum Fuse Size	Amps	20A				20A		
Features								
Controls		Microprocessor				Microprocessor		
Fan Speeds		Auto (Hi, Me, Lo)				Auto (Hi, Me, Lo)		
Compressor		DC Inverter				DC Inverter		
Refrigerant / Amount Charged at Shipment		R-410A / 6.17				R-410A / 8.38		
Refrigerant Control		Electric Expansion Valve				Electric Expansion Valve		
Operation Sound	Hi dB-A	50	52	53		55		
Refrigerant Tubing Connections	Type	Flare				Flare		
Max. Allowable Tubing Length	Ft	82 (per Unit) 200 (per System with additional Refrigerant)				100 (per Unit) 230 (per System with additional Refrigerant)		
Refrigerant Tube Diameter	Discharge inch	1/4" x 4				1/4" x 4		
	Suction inch	3/8" x 3 + 1/2" x 1				3/8" x 2 + 1/2" x 2		
Dimensions & Weight								
Unit Dimensions	H x W x D inch	29-1/8" x 35-7/16" x 12-19/32"				35-1/32" x 35-7/16" x 12-19/32"		
Net Weight	Lbs.	143.3				181.0		

IMPORTANT It is not possible to connect an outdoor unit to only a single indoor unit. If operated with only ONE indoor unit installed, the returning refrigerant to the compressor may cause a malfunction.

* Test Conditions based on AHRI 210/240

RAC Multi-Combination Tables Cooling

Most popular combinations refer to technical manual for complete listing of combinations.

CU-3KE19NBU

	Indoor Unit Combination		Indoor Unit Capacity (BTU/h)												
			COOLING						HEATING						
			Room A	Room B	Room C	Total Performance			Room A	Room B	Room C	Total Performance			
						Capacity	Min.	Max.	Capacity	Min.	Max.	Capacity	Min.	Max.	
2-room Operation	7,500 + 7,500	= 15,000	7,500	7,500			15,000	(6,800 - 17,400)		8,500	8,500			17,000	(6,800 - 21,800)
	7,500 + 9,000	= 16,500	7,500	9,000			16,500	(6,800 - 18,600)		8,525	12,275			20,800	(7,100 - 24,800)
	7,500 + 11,900	= 19,400	6,727	10,673			17,400	(6,800 - 18,600)		8,358	14,042			22,400	(7,100 - 24,800)
	7,500 + 17,500	= 25,000	5,520	12,880			18,400	(7,100 - 18,600)		7,000	16,800			23,800	(8,100 - 24,800)
	9,000 + 9,000	= 18,000	8,500	8,500			17,000	(6,800 - 18,600)		11,600	11,600			23,200	(7,800 - 24,800)
	9,000 + 11,900	= 20,900	7,622	10,078			17,700	(7,100 - 18,600)		10,800	12,600			23,400	(7,800 - 24,800)
	9,000 + 17,500	= 26,500	6,317	12,283			18,600	(7,100 - 18,600)		9,075	15,125			24,200	(8,100 - 24,800)
	11,900 + 11,900	= 23,800	9,200	9,200			18,400	(6,800 - 18,600)		11,900	11,900			23,800	(7,800 - 24,800)
11,900 + 17,500	= 29,400	7,529	11,071			18,600	(7,100 - 18,600)		10,129	14,471			24,600	(8,100 - 24,800)	
3-room Operation	7,500 + 7,500 + 7,500	= 22,500	6,000	6,000	6,000		18,000	(8,500 - 18,600)		7,800	7,800	7,800		23,400	(9,200 - 24,800)
	7,500 + 7,500 + 9,000	= 24,000	5,750	5,750	6,900		18,400	(9,800 - 18,600)		6,919	6,919	9,963		23,800	(10,200 - 24,800)
	7,500 + 7,500 + 11,900	= 26,900	5,186	5,186	8,228		18,600	(9,800 - 18,600)		6,576	6,578	11,048		24,200	(10,900 - 24,800)
	7,500 + 7,500 + 17,500	= 32,500	4,292	4,292	10,015		18,600	(9,800 - 18,600)		5,636	5,636	13,527		24,800	(11,600 - 24,800)
	7,500 + 9,000 + 9,000	= 25,500	5,471	6,565	6,565		18,600	(9,800 - 18,600)		6,237	8,981	8,981		24,200	(11,600 - 24,800)
	7,500 + 9,000 + 11,900	= 28,400	4,912	5,894	7,794		18,600	(9,800 - 18,600)		5,971	8,598	10,031		24,600	(11,600 - 24,800)
	7,500 + 9,000 + 17,500	= 34,000	4,103	4,924	9,574		18,600	(9,800 - 18,600)		5,124	7,379	12,298		24,800	(11,600 - 24,800)
	7,500 + 11,900 + 11,900	= 31,300	4,457	7,072	7,072		18,600	(9,800 - 18,600)		5,688	9,556	9,556		24,800	(11,600 - 24,800)
	9,000 + 9,000 + 9,000	= 27,000	6,200	6,200	6,200		18,600	(9,800 - 18,600)		8,267	8,267	8,267		24,800	(11,600 - 24,800)
	9,000 + 9,000 + 11,900	= 29,900	5,599	5,599	7,403		18,600	(9,800 - 18,600)		7,832	7,832	9,137		24,800	(11,600 - 24,800)
	9,000 + 11,900 + 11,900	= 32,800	5,104	6,748	6,748		18,600	(9,800 - 18,600)		7,440	8,680	8,680		24,800	(11,600 - 24,800)
11,900 + 11,900 + 11,900	= 35,700	6,200	6,200	6,200		18,600	(9,800 - 18,600)		8,267	8,267	8,267		24,800	(11,600 - 24,800)	

CU-4KE24NBU

	Indoor Unit Combination		Indoor Unit Capacity (BTU/h)														
			COOLING							HEATING							
			Room A	Room B	Room C	Room D	Total Performance			Room A	Room B	Room C	Room D	Total Performance			
								Capacity	Min.	Max.	Capacity	Min.	Max.	Capacity	Min.	Max.	
2-room Operation	7,500 + 7,500	= 15,000	7,500	7,500					15,000	(6,800 - 17,400)		8,500	8,500			17,000	(6,800 - 21,800)
	7,500 + 9,000	= 16,500	7,500	9,000					16,500	(6,800 - 19,700)		8,500	12,200			20,800	(7,100 - 25,400)
	7,500 + 11,900	= 19,400	7,500	11,900					19,400	(6,800 - 22,800)		8,500	14,300			22,800	(7,100 - 28,200)
	7,500 + 17,500	= 25,000	6,720	15,680					22,400	(7,100 - 23,200)		8,500	20,400			28,200	(8,100 - 29,200)
	7,500 + 24,200	= 31,700	5,489	17,711					23,200	(7,100 - 23,200)		8,500	29,000			29,200	(8,100 - 29,200)
	9,000 + 9,000	= 18,000	9,000	9,000					18,000	(6,800 - 21,400)		12,200	12,200			24,400	(7,800 - 29,000)
	9,000 + 11,900	= 20,900	8,612	11,388					20,000	(6,800 - 23,200)		12,200	14,300			25,800	(7,800 - 29,000)
	9,000 + 17,500	= 26,500	7,743	15,057					22,800	(7,100 - 23,200)		12,200	20,400			28,600	(8,100 - 29,200)
	9,000 + 24,200	= 33,200	6,289	16,911					23,200	(7,100 - 23,200)		12,200	29,000			29,200	(8,100 - 29,200)
	11,900 + 11,900	= 23,800	11,200	11,200					22,400	(6,800 - 23,200)		14,300	14,300			27,200	(7,800 - 29,000)
	11,900 + 17,500	= 29,400	9,390	13,810					23,200	(7,100 - 23,200)		14,300	20,400			29,000	(8,100 - 29,200)
11,900 + 24,200	= 36,100	7,648	15,552					23,200	(7,100 - 23,200)		14,300	29,000			29,200	(8,100 - 29,200)	
17,500 + 17,500	= 35,000	11,600	11,600					23,200	(7,100 - 23,200)		20,400	20,400			29,200	(8,100 - 29,200)	
3-room Operation	7,500 + 7,500 + 7,500	= 22,500	7,333	7,333	7,333				22,000	(8,500 - 23,200)		8,500	8,500	8,500		25,400	(9,200 - 29,000)
	7,500 + 7,500 + 9,000	= 24,000	7,000	7,000	8,400				22,400	(9,800 - 23,200)		8,500	8,500	12,200		27,200	(10,200 - 29,200)
	7,500 + 7,500 + 11,900	= 26,900	6,413	6,413	10,175				23,000	(9,800 - 23,200)		8,500	8,500	14,300		28,200	(10,900 - 29,200)
	7,500 + 7,500 + 17,500	= 32,500	5,354	5,354	12,492				23,200	(9,800 - 23,200)		8,500	8,500	20,400		29,200	(11,600 - 29,200)
	7,500 + 9,000 + 9,000	= 25,500	6,706	8,047	8,047				22,800	(9,800 - 23,200)		8,500	12,200	12,200		28,600	(11,600 - 29,200)
	7,500 + 9,000 + 11,900	= 28,400	6,127	7,352	9,721				23,200	(9,800 - 23,200)		8,500	12,200	14,300		29,000	(11,600 - 29,200)
	7,500 + 9,000 + 17,500	= 34,000	5,118	6,141	11,941				23,200	(9,800 - 23,200)		8,500	12,200	20,400		29,200	(11,600 - 29,200)
	7,500 + 11,900 + 11,900	= 31,300	5,559	8,820	8,820				23,200	(9,800 - 23,200)		8,500	14,300	14,300		29,200	(11,600 - 29,200)
	7,500 + 11,900 + 17,500	= 36,900	4,715	7,482	11,003				23,200	(9,800 - 23,200)		8,500	14,300	20,400		29,200	(11,600 - 29,200)
	9,000 + 9,000 + 9,000	= 27,000	7,733	7,733	7,733				23,200	(9,800 - 23,200)		12,200	12,200	12,200		29,200	(11,600 - 29,200)
	9,000 + 9,000 + 11,900	= 29,900	6,983	6,983	9,233				23,200	(9,800 - 23,200)		12,200	12,200	14,300		29,200	(11,600 - 29,200)
	9,000 + 9,000 + 17,500	= 35,500	5,882	5,882	11,437				23,200	(9,800 - 23,200)		12,200	12,200	20,400		29,200	(11,600 - 29,200)
	9,000 + 11,900 + 11,900	= 32,800	6,366	8,417	8,417				23,200	(9,800 - 23,200)		12,200	14,300	14,300		29,200	(11,600 - 29,200)
9,000 + 11,900 + 17,500	= 38,400	5,438	7,190	10,573				23,200	(9,800 - 23,200)		12,200	14,300	20,400		29,200	(11,600 - 29,200)	
11,900 + 11,900 + 11,900	= 35,700	7,733	7,733	7,733				23,200	(9,800 - 23,200)		14,300	14,300	14,300		29,200	(11,600 - 29,200)	
11,900 + 11,900 + 17,500	= 41,300	6,685	6,685	9,831				23,200	(9,800 - 23,200)		14,300	14,300	20,400		29,200	(11,600 - 29,200)	
4-room Operation	7,500 + 7,500 + 7,500 + 7,500	= 30,000	5,800	5,800	5,800	5,800			23,200	(9,800 - 23,200)		7,300	7,300	7,300	7,300	29,200	(11,600 - 29,200)
	7,500 + 7,500 + 7,500 + 9,000	= 31,500	5,524	5,524	5,524	6,629			23,200	(9,800 - 23,200)		6,952	6,952	6,952	8,343	29,200	(11,600 - 29,200)
	7,500 + 7,500 + 7,500 + 11,900	= 34,400	5,058	5,058	5,058	8,026			23,200	(9,800 - 23,200)		6,366	6,366	6,366	10,101	29,200	(11,600 - 29,200)
	7,500 + 7,500 + 7,500 + 17,500	= 40,000	4,350	4,350	4,350	10,150			23,200	(9,800 - 23,200)		5,475	5,475	5,475	12,775	29,200	(11,600 - 29,200)
	7,500 + 7,500 + 9,000 + 9,000	= 33,000	5,273	5,273	6,327	6,327			23,200	(9,800 - 23,200)		6,636	6,636	7,964	7,964	29,200	(11,600 - 29,200)
	7,500 + 7,500 + 9,000 + 11,900	= 35,900	4,847	4,847	5,816	7,690			23,200	(9,800 - 23,200)		6,100	6,100	7,320	9,679	29,200	(11,600 - 29,200)
	7,500 + 7,500 + 9,000 + 17,500	= 41,500	4,193	4,193	5,031	9,783			23,200	(9,800 - 23,200)		5,277	5,277	6,333	12,313	29,200	(11,600 - 29,200)
	7,500 + 7,500 + 11,900 + 11,900	= 38,800	4,485	4,485	7,115	7,115			23,200	(9,800 - 23,200)		5,644	5,644	8,956	8,956	29,200	(11,600 - 29,200)
	7,500 + 7,500 + 11,900 + 17,500	= 44,400	3,919	3,919													

CU-4KE31NBU

	Indoor Unit Combination		Indoor Unit Capacity (BTU/h)												
			COOLING						HEATING						
			Room A	Room B	Room C	Room D	Total Performance				Room A	Room B	Room C	Room D	Total Performance
				Capacity (Min. - Max.)				Capacity (Min. - Max.)							
2-room Operation	7500 + 7,500	= 15,000	7,500	7,500			15,000 (4,400 - 17,400)	8,500	8,500					17,000 (6,800 - 21,800)	
	7500 + 9,000	= 16,500	7,500	9,000			16,500 (5,100 - 19,700)	8,541	12,259					20,800 (7,100 - 25,400)	
	7500 + 11,900	= 19,400	7,500	11,900			19,400 (5,800 - 22,800)	8,500	14,300					22,800 (7,800 - 28,200)	
	7500 + 17,500	= 25,000	7,320	17,080			24,400 (7,500 - 26,200)	8,529	20,471					29,000 (10,200 - 32,000)	
	7500 + 24,200	= 31,700	6,625	21,375			28,000 (7,800 - 30,000)	6,800	23,200					30,000 (10,200 - 32,000)	
	9000 + 9,000	= 18,000	9,000	9,000			18,000 (5,800 - 22,000)	12,200	12,200					24,400 (8,100 - 29,000)	
	9000 + 11,900	= 20,900	8,957	11,843			20,800 (6,400 - 25,200)	11,878	13,922					25,800 (8,800 - 29,000)	
	9000 + 17,500	= 26,500	8,626	16,774			25,400 (7,800 - 29,000)	11,002	18,398					29,400 (11,200 - 32,000)	
	9000 + 24,200	= 33,200	7,861	21,139			29,000 (7,800 - 30,000)	9,061	21,539					30,600 (11,200 - 32,000)	
	11900 + 11,900	= 23,800	11,900	11,900			23,800 (7,500 - 28,600)	13,600	13,600					27,200 (9,800 - 29,000)	
	11900 + 17,500	= 29,400	10,848	15,952			26,800 (8,800 - 30,000)	12,281	17,519					29,800 (11,600 - 32,000)	
	11900 + 24,200	= 36,100	9,625	19,575			29,200 (8,800 - 30,000)	10,238	20,762					31,000 (11,600 - 32,000)	
	17500 + 17,500	= 35,000	14,500	14,500			29,000 (8,800 - 30,000)	15,300	15,300					30,600 (11,600 - 32,000)	
	17500 + 24,200	= 41,700	12,296	17,004			29,300 (9,200 - 30,000)	13,215	18,785					32,000 (11,600 - 32,000)	
3-room Operation	7500 + 7,500 + 7,500	= 22,500	7,467	7,467	7,467		22,400 (6,800 - 26,200)	8,467	8,467	8,467				25,400 (9,200 - 30,600)	
	7500 + 7,500 + 9,000	= 24,000	7,500	7,500	9,000		24,000 (7,500 - 26,600)	8,442	8,442	12,116				29,000 (10,200 - 31,200)	
	7500 + 7,500 + 11,900	= 26,900	7,082	7,082	11,236		25,400 (8,100 - 26,800)	7,930	7,930	13,341				29,200 (10,900 - 32,000)	
	7500 + 7,500 + 17,500	= 32,500	6,600	6,600	15,400		28,600 (9,200 - 30,600)	6,818	6,818	16,364				30,000 (11,600 - 32,000)	
	7500 + 7,500 + 24,200	= 39,200	5,587	5,587	18,027		29,200 (9,800 - 30,600)	5,802	5,802	19,796				31,400 (11,600 - 32,000)	
	7500 + 9,000 + 9,000	= 25,500	7,294	8,753	8,753		24,800 (7,800 - 27,200)	7,596	10,902	10,902				29,400 (11,200 - 31,600)	
	7500 + 9,000 + 11,900	= 28,400	6,972	8,366	11,062		26,400 (8,800 - 27,600)	7,237	10,387	12,175				29,800 (11,600 - 32,000)	
	7500 + 9,000 + 17,500	= 34,000	6,309	7,571	14,721		28,600 (9,800 - 30,600)	6,328	9,083	15,188				30,600 (11,600 - 32,000)	
	7500 + 9,000 + 24,200	= 40,700	5,381	6,457	17,362		29,200 (9,800 - 30,600)	5,473	7,855	18,672				32,000 (11,600 - 32,000)	
	7500 + 11,900 + 11,900	= 31,300	6,613	10,493	10,493		27,600 (9,200 - 28,600)	6,873	11,563	11,563				30,000 (11,600 - 32,000)	
	7500 + 11,900 + 17,500	= 36,900	5,935	9,417	13,848		29,200 (9,800 - 30,600)	6,100	10,262	14,639				31,000 (11,600 - 32,000)	
	7500 + 11,900 + 24,200	= 43,600	5,023	7,970	16,207		29,200 (9,800 - 30,600)	5,251	8,834	17,915				32,000 (11,600 - 32,000)	
	7500 + 17,500 + 17,500	= 42,500	5,153	12,024	12,024		29,200 (9,800 - 30,600)	5,517	13,241	13,241				32,000 (11,600 - 32,000)	
	7500 + 17,500 + 24,200	= 49,200	4,451	10,386	14,363		29,200 (9,800 - 30,600)	4,698	11,275	16,028				32,000 (11,600 - 32,000)	
	9000 + 9,000 + 9,000	= 27,000	8,533	8,533	8,533		26,600 (8,500 - 27,200)	10,000	10,000	10,000				30,000 (11,600 - 32,000)	
	9000 + 9,000 + 11,900	= 29,900	8,187	8,187	10,825		27,200 (9,200 - 28,200)	9,520	9,520	11,159				30,200 (11,600 - 32,000)	
	9000 + 9,000 + 17,500	= 35,500	7,352	7,352	14,296		29,000 (9,800 - 30,600)	8,496	8,496	14,207				31,200 (11,600 - 32,000)	
	9000 + 9,000 + 24,200	= 42,200	6,185	6,185	16,630		29,000 (9,800 - 30,600)	7,311	7,311	17,378				32,000 (11,600 - 32,000)	
	9000 + 11,900 + 11,900	= 32,800	7,848	10,376	10,376		28,600 (9,200 - 29,200)	9,150	10,725	10,725				30,600 (11,600 - 32,000)	
	9000 + 11,900 + 17,500	= 38,400	6,844	9,049	13,307		29,200 (9,800 - 30,600)	8,220	9,635	13,745				31,600 (11,600 - 32,000)	
	9000 + 11,900 + 24,200	= 45,100	5,827	7,705	15,668		29,200 (9,800 - 30,600)	7,034	8,245	16,721				32,000 (11,600 - 32,000)	
	9000 + 17,500 + 17,500	= 44,000	5,973	11,614	11,614		29,200 (9,800 - 30,600)	7,366	12,317	12,317				32,000 (11,600 - 32,000)	
	11900 + 11,900 + 11,900	= 35,700	9,267	9,267	9,267		27,800 (9,800 - 29,000)	10,333	10,333	10,333				31,000 (11,600 - 32,000)	
	11900 + 11,900 + 17,500	= 41,300	8,414	8,414	12,373		29,200 (9,800 - 30,600)	9,280	9,280	13,239				31,800 (11,600 - 32,000)	
	11900 + 11,900 + 24,200	= 48,000	7,239	7,239	14,722		29,200 (9,800 - 30,600)	7,944	7,944	16,111				32,000 (11,600 - 32,000)	
	11900 + 17,500 + 17,500	= 46,900	7,409	10,896	10,896		29,200 (9,800 - 30,600)	8,305	11,848	11,848				32,000 (11,600 - 32,000)	
	4-room Operation	7500 + 7,500 + 7,500 + 7,500	= 30,000	7,050	7,050	7,050	7,050	28,200 (9,800 - 28,200)	7,400	7,400	7,400	7,400			29,600 (11,600 - 32,000)
		7500 + 7,500 + 7,500 + 9,000	= 31,500	6,905	6,905	6,905	8,286	29,000 (9,800 - 29,000)	6,899	6,899	6,899	9,903			30,600 (11,600 - 32,000)
		7500 + 7,500 + 7,500 + 11,900	= 34,400	6,453	6,453	6,453	10,240	29,600 (9,800 - 29,600)	6,577	6,577	6,577	11,069			30,800 (11,600 - 32,000)
7500 + 7,500 + 7,500 + 17,500		= 40,000	5,738	5,738	5,738	13,388	30,600 (9,800 - 30,600)	5,815	5,815	5,815	13,956			31,400 (11,600 - 32,000)	
7500 + 7,500 + 7,500 + 24,200		= 46,700	4,914	4,914	4,914	15,857	30,600 (9,800 - 30,600)	4,991	4,991	4,991	17,028			32,000 (11,600 - 32,000)	
7500 + 7,500 + 9,000 + 9,000		= 33,000	6,636	6,636	7,964	7,964	29,200 (9,800 - 29,200)	6,324	6,324	9,076	9,076			30,800 (11,600 - 32,000)	
7500 + 7,500 + 9,000 + 11,900		= 35,900	6,267	6,267	7,521	9,944	30,000 (9,800 - 30,000)	6,097	6,097	8,750	10,257			31,200 (11,600 - 32,000)	
7500 + 7,500 + 9,000 + 17,500		= 41,500	5,530	5,530	6,636	12,904	30,600 (9,800 - 30,600)	5,484	5,484	7,871	13,161			32,000 (11,600 - 32,000)	
7500 + 7,500 + 9,000 + 24,200		= 48,200	4,761	4,761	5,714	15,363	30,600 (9,800 - 30,600)	4,674	4,674	6,708	15,945			32,000 (11,600 - 32,000)	
7500 + 7,500 + 11,900 + 11,900		= 38,800	5,915	5,915	9,385	9,385	30,600 (9,800 - 30,600)	5,816	5,816	9,784	9,784			31,200 (11,600 - 32,000)	
7500 + 7,500 + 11,900 + 17,500		= 44,400	5,169	5,169	8,201	12,061	30,600 (9,800 - 30,600)	5,261	5,261	8,851	12,627			32,000 (11,600 - 32,000)	
7500 + 7,500 + 17,500 + 17,500		= 50,000	4,590	4,590	10,710	10,710	30,600 (9,800 - 30,600)	4,706	4,706	11,294	11,294			32,000 (11,600 - 32,000)	
7500 + 9,000 + 9,000 + 9,000		= 34,500	6,217	7,461	7,461	7,461	28,600 (9,800 - 28,600)	5,880	8,440	8,440	8,440			31,200 (11,600 - 32,000)	
7500 + 9,000 + 9,000 + 11,900		= 37,400	6,136	7,364	7,364	9,736	30,600 (9,800 - 30,600)	5,691	8,168	8,168	9,574			31,600 (11,600 - 32,000)	
7500 + 9,000 + 9,000 + 17,500		= 43,000	5,337	6,405	6,405	12,453	30,600 (9,800 - 30,600)	5,103	7,325	7,325	12,248			32,000 (11,600 - 32,000)	
7500 + 9,000 + 11,900 + 11,900		= 40,300	5,695	6,834	9,036	9,036	30,600 (9,800 - 30,600)	5,517	7,919	9,282	9,282			32,000 (11,600 - 32,000)	
7500 + 9,000 + 11,900 + 17,500		= 45,900	5,000	6,000	7,933	11,667	30,600 (9,800 - 30,600)	4,910	7,047	8,260	11,783			32,000 (11,600 - 32,000)	
7500 + 11,900 + 11,900 + 11,900		= 43,200	5,313	8,429	8,429	8,429	30,600 (9,800 - 30,600)	5,292	8,903	8,903	8,903			32,000 (11,600 - 32,000)	
7500 + 11,900 + 11,900 + 17,500		= 48,800	4,703	7,462	7,462	10,973	30,600 (9,800 - 30,600)	4,730	7,958	7,958	11,353			32,000 (11,600 - 32,000)	
9000 + 9,000 + 9,000 + 9,000		= 36,000	7,650	7,650	7,650	7,650	30,600 (9,800 - 30,600)	8,000	8,000	8,000	8,000			32,000 (11,600 - 32,000)	
9000 + 9,000 + 9,000 + 11,900		= 38,900	7,080	7,080	7,080	9,361	30,600 (9,800 - 30,600)	7,670	7,670	7,670	8,990			32,000 (11,600 - 32,000)	
9000 + 9,000 + 9,000 + 17,500		= 44,500	6,189	6,189	6,189	12,034	30,600 (9,800 - 30,600)	6,849	6,849	6,849	11,453			32,000 (11,600 - 32,000)	
9000 + 9,000 + 11,900 + 11,900		= 41,800	6,589	6,589	8,71										

Ceiling-Suspended Heat Pumps

26PET1U6



Indoor Unit
S-26PT1U6

36PET1U6 / 42PET1U6



Indoor Unit
S-36PT1U6 / S-42PT1U6



Outdoor Unit
U-26PE1U6



Wired Remote Controller
(Included)

Wireless Remote Controller
(Optional)



Outdoor Unit
U-36PE1U6



Outdoor Unit
U-42PE1U6



Wired Remote Controller
(Included)

Wireless Remote Controller
(Optional)

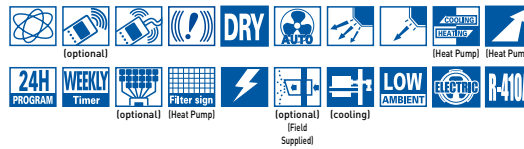

Quiet Operation

The ceiling-mounted unit is equipped with a highly efficient, multi-blade centrifugal fan that generates a powerful, yet gentle airflow throughout the room. A redesigned aerodynamically tested louver structure minimizes operational sound even at high fan speed.



Improved Serviceability / Easy Installation

External suspension method. Installation time can be shortened.

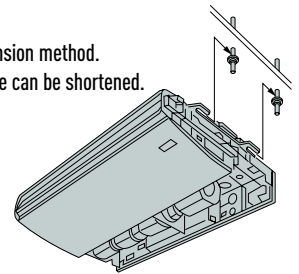

Improved accessibility to electronic components (control box) for servicing.



Auto-Louver Function Provides Optimum Airflow During Heating or Cooling Operation

Auto-louver function is a standard feature which provides optimum airflow during heating or cooling operation. Angle of louver is automatically set for heating or cooling. For example, when heating with fan speed set to low, the discharge is aimed downward so that warm air reaches the floor. The louver angle can be set to between 4°F above and 80°F below the horizontal in five steps. An auto-sweep function to distribute the airflow over a wide area is also provided. Wind direction is adjusted automatically in both heating and cooling operation. The louver can also be set to swing automatically from F1 to F5 in any operation mode (heat pump type only).

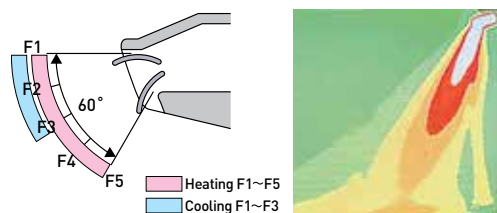

Fresh Air Intake Capability and Duct Extension

Ceiling-suspended models have the capability of bringing fresh air from outside using an air-intake duct (field supplied).

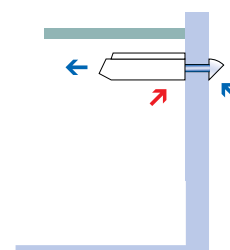

Ceiling - Suspended										
		Heat Pumps								
Model No.		26PET1U6		36PET1U6		42PET1U6				
Unit Model No.		Indoor Unit S-26PT1U6	Outdoor Unit U-26PE1U6	Indoor Unit S-36PT1U6	Outdoor Unit U-36PE1U6	Indoor Unit S-42PT1U6	Outdoor Unit U-42PE1U6			
Performance & Electrical Ratings										
Capacity	Cooling	24,400 (9,500-24,400)		31,200 (9,500-31,200)		39,000 (9,500-39,000)				
	Heating	30,800 (8,000-30,800)		37,400 (8,000-37,400)		44,500 (8,000-44,500)				
Moisture Removal	High	7.7		10.0		12.6				
Dry Air Flow	Hi / Med / Low	550 / 490 / 460		1,100 / 930 / 750		1,130 / 950 / 775				
SEER	Cooling	14.5		15.1		15.6				
EER	Cooling	8.5		8.10		9.4				
HSPF	Heating	9.4		8.8		9.5				
Power Supply	V, Phase, Hz	230 / 208 / 1 / 60		230 / 208 / 1 / 60		230 / 208 / 1 / 60				
Running Amps	Cooling	15.6 / 17.3		18.2 / 20.1		21.1 / 23.3				
	Heating	16.4 / 18.1		15.6 / 17.3		18.6 / 20.6				
Power Input	Cooling	2,880 / 2,880		3,840 / 3,840		4,140 / 4,140				
	Heating	3,000 / 3,000		3,250 / 3,250		3,630 / 3,630				
Fuse or Circuit Breaker Capacity	A	15	30	15	35	15	40			
Features										
Controls	Microprocessor			Microprocessor			Microprocessor			
Low Ambient Control (for Cooling)	Built-in 0°F			Built-in 0°F			Built-in 0°F			
Wireless Remote Controller (optional)	CZ-RWSU2U, CZ-RWSC1U			CZ-RWSU2U, CZ-RWSC1U			CZ-RWSU2U, CZ-RWSC1U			
Wired Remote Controller (included)	CZ-RTC2			CZ-RTC2			CZ-RTC2			
Fan Speeds	3 and Automatic Control / Variable			3 and Automatic Control / Variable			3 and Automatic Control / Variable			
Timer	7 Days / 6 Events			7 Days / 6 Events			7 Days / 6 Events			
Air Deflection	Horizontal	---			---			---		
	Vertical	Automatic			Automatic			Automatic		
Air Filter	Washable			Washable			Washable			
Refrigerant	R-410A			R-410A			R-410A			
Refrigerant control	Electric Expansion Valve			Electric Expansion Valve			Electric Expansion Valve			
Operation Sound	In (Hi / Me / Lo)	39 / 37 / 33		42 / 40 / 35		44 / 41 / 37				
	Outdoor (Hi)	49		52		53				
Refrigerant Piping	Type	Flare			Flare			Flare		
	Discharge	3/8"			3/8"			3/8"		
	Suction	5/8"			5/8"			5/8"		
Refrigerant Pipe Length	FL	Max. 165		Max. 165		Max. 165				
Elevation Difference*	Outdoor Above	Max. 100		Max. 100		Max. 100				
	Outdoor Below	Max. 50		Max. 50		Max. 50				
Dimensions & Weight										
Height	inches	7-17/32"		30-23/32"		9-7/16"		48-7/16"		
Width	inches	51-3/16"		37"		62-1/32"		37"		
Depth	inches	26-3/8"		13-3/8"		26-3/8"		13-3/8"		
Net Weight	Lbs.	57.0		128.0		84.0		220.0		

* This is maximum elevation difference when the indoor unit is located above the outdoor unit. (Refer to the table on the back of the catalog)

Ceiling-Recessed Heat Pumps

E12RB4U / E18RB4U

Indoor Unit
CS-E12RB4UW
CS-E18RB4UW

Grille Assembly
CZ-BT20U



Wireless Remote Controller (Included)
Wired Remote Controller (Optional)



Outdoor Unit
CU-E12RB4U



Outdoor Unit
CU-E18RB4U



26PEU1U6

Indoor Unit
S-26PU1U6

Grille Assembly
CZ-24KPU1U



36PEU1U6 / 42PEU1U6

Indoor Unit
S-36PU1U6 / S-42PU1U6

Grille Assembly
CZ-36KPU1U



Outdoor Unit
U-26PE1U6



Wired Remote Controller (Included)



Outdoor Unit
U-36PE1U6



Outdoor Unit
U-42PE1U6



Wired Remote Controller (Included)



4-Way Airflow Design Sends Cool Air in all Directions

Air is returned through the center of the grille, while evenly distributing air through each of the 4 supply air openings. Installation in the center of the room provides for the greatest comfort. However, 1 or 2 supply louvers can be closed for installation near 1 wall to provide 3 or 2 way airflow. Also, by closing off 1 supply louver, you may attach a duct (field supply) to the upper plenum and provide conditioned air to another, separate area.

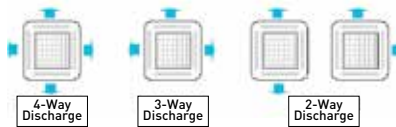
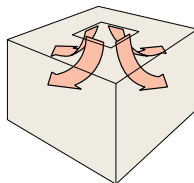

Integrated Drain Pump

Drain pump is built into the unit to raise the condensate up 20 inches from the drain pump discharge.

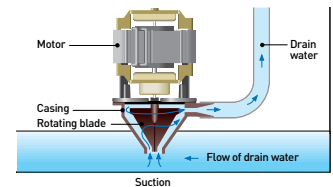

Fresh Air Intake Plenum (Option)

When used to take in fresh air, attach the optional fresh air-intake plenum to the unit.
CZ-26BCU1U for S-26PU1U6
CZ-42BCU1U for S-36/42PU1U6

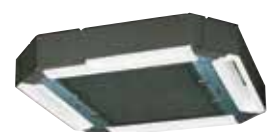

Whisper-Quiet Operation

Thanks to the newly developed turbo fan and decreased resistance of the air path, one of the industry's lowest levels of noise has been achieved.

Ceiling - Recessed			Heat Pumps			
Model No.			E12RB4U		E18RB4U	
Unit Model No.			Indoor Unit	Outdoor Unit	Indoor Unit	Outdoor Unit
			CS-E12RB4UW	CU-E12RB4U	CS-E18RB4UW	CU-E18RB4U
Grille Assembly			CZ-BT20U		CZ-BT20U	
Performance & Electrical Ratings						
Capacity	Cooling	Btu/h	11,900 (4,100-13,100)		17,500 (4,400-18,700)	
	Heating	Btu/h	13,600 (4,100-16,300)		20,400 (4,400-21,000)	
Moisture Removal	High	Pints/H	4		6.1	
Dry Air Flow	Heating / Cooling	CFM	390 / 370		495 / 450	
SEER	Cooling	Btu/Wh	18		17.5	
EER	Cooling	Btu/Wh	10.3		10.25	
HSPF	Heating	Btu/Wh	9		8.5	
Power Supply	V, Phase, Hz		208/230V, Single phase, 60Hz		208/230V, Single phase, 60Hz	
Running Amps	Cooling	A	6 (1.25-6.3)		9.1 (1.2-8.3)	
	Heating	A	6.9 (1.25-7.3)		12.5 (1.3-10.5)	
Power Input	Cooling	W	1,150 (250-1,320)		1,700 (250-1,850)	
	Heating	W	1,360 (230-1,710)		2,340 (270-2,500)	
Fuse or Circuit Breaker Capacity	A		15		25	
Features						
Controls			Microprocessor		Microprocessor	
Low Ambient Control (for Cooling)			Equipped		Equipped	
Wireless Remote Controller			Included		Included	
Wired Remote Controller (optional)			CZ-RD52CU		CZ-RD52CU	
Fan Speeds			Hi/Me/Lo & Auto		Hi/Me/Lo & Auto	
Air Deflection	Horizontal		---		---	
	Vertical		Microprocessor		Automatic	
Air Filter			Washable		Washable	
Refrigerant			R-410A		R-410A	
Refrigerant Control			Electric Expansion Valve		Electric Expansion Valve	
Operation Sound	In (Hi / Me / Lo)	dB-A	34 / 30 / 27		44 / 31 / 28	
	Outdoor (Hi)	dB-A	51 (Max. 66)		52 (Max. 66)	
Refrigerant Piping (Cooling)	Type		Flare		Flare	
	Discharge	inches	1/4"		1/4"	
	Suction	inches	1/2"		1/2"	
Refrigerant Pipe Length		Ft.	65		100	
Elevation Difference*	Outdoor Above	Ft.	49		49	
	Outdoor Below	Ft.	49		49	
Dimensions & Weight						
Height		inches	10-1/4"		10-1/4"	
Width		inches	22-3/4"		22-3/4"	
Depth		inches	22-3/4"		22-3/4"	
Net Weight		Lbs.	40		132	

Ceiling - Recessed			Heat Pumps					
Model No.			26PEU1U6		36PEU1U6		42PEU1U6	
Unit Model No.			Indoor Unit	Outdoor Unit	Indoor Unit	Outdoor Unit	Indoor Unit	Outdoor Unit
			S-26PU1U6	U-26PE1U6	S-36PU1U6	U-36PE1U6	S-42PU1U6	U-42PE1U6
Grille Assembly			CZ-24KPU1U		CZ-36KPU1U		CZ-36KPU1U	
Performance & Electrical Ratings								
Capacity	Cooling	Btu/h	24,800 (9,500-24,800)		32,600 (9,500-32,600)		39,500 (9,500-39,500)	
	Heating	Btu/h	29,800 (8,000-29,800)		37,600 (8,000-37,600)		48,000 (8,000-48,000)	
Moisture Removal	High	Pints/H	8.1		10.6		12.6	
Dry Air Flow	Hi / Med / Low	CFM	710 / 530 / 450		1,050 / 840 / 720		1,050 / 840 / 720	
SEER	Cooling		14.1		14.6		14.6	
EER	Cooling		8.5		8.1		8.7	
HSPF	Heating		9.6		8.4		9.7	
Power Supply	V, Phase, Hz		230 / 208 / 1 / 60		230 / 208 / 1 / 60		230 / 208 / 1 / 60	
Running Amps	Cooling	A	15.6 / 17.3		18.7 / 20.7		23.0 / 25.4	
	Heating	A	14.8 / 16.4		15.9 / 17.6		22.4 / 24.8	
Power Input	Cooling	W	2,920 / 2,920		3,950 / 3,950		4,520 / 4,520	
	Heating	W	2,790 / 2,790		3,350 / 3,350		4,360 / 4,360	
Fuse or Circuit Breaker Capacity	A		15	30	15	35	15	40
Features								
Controls			Microprocessor		Microprocessor		Microprocessor	
Low Ambient Control (for Cooling)			Built-in 0°F		Built-in 0°F		Built-in 0°F	
Wireless Remote Controller (optional)			CZ-RWSU2U, CZ-RWSC1U		CZ-RWSU2U, CZ-RWSC1U		CZ-RWSU2U, CZ-RWSC1U	
Wired Remote Controller (included)			CZ-RTC2		CZ-RTC2		CZ-RTC2	
Fan Speeds			3 and Automatic Control / Variable		3 and Automatic Control / Variable		3 and Automatic Control / Variable	
Timer			7 Days / 6 Events		7 Days / 6 Events		7 Days / 6 Events	
Air Deflection	Horizontal		---		---		---	
	Vertical		Automatic		Automatic		Automatic	
Air Filter			Washable		Washable		Washable	
Refrigerant			R-410A		R-410A		R-410A	
Refrigerant Control			Electric Expansion Valve		Electric Expansion Valve		Electric Expansion Valve	
Operation Sound	In (Hi / Me / Lo)	dB-A	38 / 35 / 31		44 / 37 / 33		45 / 38 / 34	
	Outdoor (Hi)	dB-A	49		52		53	
Refrigerant Piping	Type		Flare		Flare		Flare	
	Discharge	inches	3/8"		3/8"		3/8"	
	Suction	inches	5/8"		5/8"		5/8"	
Refrigerant Pipe Length		Ft.	Max. 165		Max. 165		Max. 165	
Elevation Difference*	Outdoor Above	Ft.	Max. 100		Max. 100		Max. 100	
	Outdoor Below	Ft.	Max. 50		Max. 50		Max. 50	
Dimensions & Weight								
Height		inches	13-5/16"		14-31/64"		14-31/64"	
Width		inches	33-55/64"		37"		37"	
Depth		inches	33-55/64"		13-3/8"		33-55/64"	
Net Weight		Lbs.	49.0		60.0		143.0	

* This is maximum elevation difference when the indoor unit is located above the outdoor unit. (Refer to the table on the back of the catalog for more detail.)

Concealed Ducted Heat Pumps

26PEF1U6

Indoor Unit S-26PF1U6

Supplies are 8" dia



Outdoor Unit U-26PE1U6

Wired Remote
Controller
(Included)



36PEF1U6

Indoor Unit S-36PF1U6

Supplies are 8" dia



Outdoor Unit U-36PE1U6

Wired Remote
Controller
(Included)



Outline diagram with medium or high-performance filter field installed.

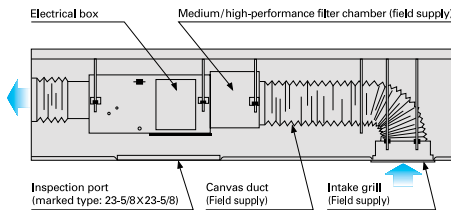

Built-In Drain Pump

Drain pump is built into the unit to raise the condensate up 20 inches from the drain pump discharge.

Installation Example

The picture shows the standard ducting system, where air is taken in from the back of the unit. This system is useful for places that need extensive air conditioning, including conference halls, showrooms, and restaurants.



		Concealed Duct Heat Pumps			
		26PEF1U6		36PEF1U6	
Model No.	Unit Model No.	Indoor Unit S-26PF1U6	Outdoor Unit U-26PE1U6	Indoor Unit S-36PF1U6	Outdoor Unit U-36PE1U6
Performance & Electrical Ratings					
Capacity	Cooling	24,000 (9,500-24,000)		31,200 (9,500-31,200)	
	Heating	28,600 (8,000-28,600)		36,200 (8,000-36,200)	
Moisture Removal	High	7.7		10.0	
Dry Air Flow	Hi / Med / Low	670 / 530 / 460		1,060 / 920 / 750	
SEER	Cooling	14.0		13.9	
EER	Cooling	9.1		7.8	
HSPF	Heating	9.0		8.5	
Power Supply	V, Phase, Hz	230/208, 1Ph, 60Hz		230/208, 1Ph, 60Hz	
Running Amps	Cooling	13.6 / 15.0		18.6 / 20.6	
	Heating	12.5 / 13.8		15.9 / 17.6	
Power Input	Cooling	2,600 / 2,600		3,920 / 3,920	
	Heating	2,400 / 2,400		3,340 / 3,340	
External Static Pressure	in. WC	0.20		0.24	
Fuse or Circuit Breaker Capacity	A	15	30	15	35
Features					
Controls		Microprocessor		Microprocessor	
Low Ambient Control		Built-in 0°F		Built-in 0°F	
Wireless Remote Controller (optional)		CZ-RWSU2U, CZ-RWSC1U		CZ-RWSU2U, CZ-RWSC1U	
Wired Remote Controller (included)		CZ-RTC2		CZ-RTC2	
Fan Speeds		3 and Automatic Control / Variable		3 and Automatic Control / Variable	
Timer		7 Days / 6 Events		7 Days / 6 Events	
Air Deflection	Horizontal	---		---	
	Vertical	---		---	
Air Filter		---		---	
Refrigerant Control		Electric Expansion Valve		Electric Expansion Valve	
Operation Sound	In (Hi / Me / Lo)	34 / 30 / 27		38 / 33 / 31	
	Outdoor (Hi)	49		52	
Refrigerant Piping	Type	Flare		Flare	
	Discharge	3/8"		3/8"	
	Suction	5/8"		5/8"	
Refrigerant Pipe Length	Ft.	Max. 165		Max. 165	
Elevation Difference**	Outdoor Above	Max. 100		Max. 100	
	Outdoor Below	Max. 50		Max. 50	
Dimensions & Weight					
Height	inches	Indoor Unit 12-7/32"	Outdoor Unit 30-23/32"	Indoor Unit 12-7/32"	Outdoor Unit 30-23/32"
Width	inches	39-3/8"		58-9/32"	
Depth	inches	24-13/16"		13-3/8"	
Net Weight	Lbs.	71.0	128.0	104.0	143.0

** This is maximum elevation difference when the indoor unit is located above the outdoor unit. (Refer to the table on the back of the catalog for more detail.)

Optional Accessories

Condensate Pump
SI-30-120
SI-30-230



Tube Size Adapter
CZ-MA1P / CZ-MA1P-US
CZ-MA2P / CZ-MA2P-US
CZ-MA3P / CZ-MA3P-US



Locking Bracket for Remote Control
RCS5PS4B
RCS4MHVB
RCPTC110B



Wired Remote Controller
CZ-RD516C-1



Timer Remote Controller
CZ-RTC2 / CZ-RTC3



Wired Remote for Econavi Ducted Systems
CZ-RTC4

Replacement Anti-microbial Filter
CZ-SA20P
CZ-FDXB

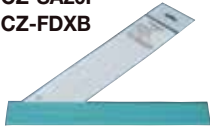

Fresh Air Intake Plenum
CZ-26BCU1U
CZ-42BCU1U



Wired Remote Controller
CZ-RD52CU



Wired Remote Controller
CZ-RD515U



System Controller
CZ-64ESMC1U



Econavi Sensor
CZ-CENSC1



Accessories		
Model No.	Description	Use With
DL04060815	Insulated Tubing Kit 1/4" x 3/8" x 1/2" x 15'	XE9PKUA, E9RKUA, E9NKUA, KE12NB41, CU-2E18NBU, CU-3KE19NBU, CU-4KE24NBU, CU-4KE31NBU, CU-5E36QBU, CS-MKE7NKU, CS-MKE9NKKU, CS-MKE12NKKU, CS-MKE9NB4U, CS-MKE12NB4U
DL04060820	Insulated Tubing Kit 1/4" x 3/8" x 1/2" x 20'	
DL04060835	Insulated Tubing Kit 1/4" x 3/8" x 1/2" x 35'	
DL04080815	Insulated Tubing Kit 1/4" x 1/2" x 1/2" x 15'	XE12PKUA, E12RKUA, E12NKUA, E12RB4U, E18RKUA, E18NKUA, E18RB4U, KE18NB4U, CU-3KE19NBU, CU-4KE24NBU, CU-4KE31NBU, CU-5E36QBU, CS-MKE18NKKU, CS-KE18NB4U
DL04080820	Insulated Tubing Kit 1/4" x 1/2" x 1/2" x 20'	
DL04080835	Insulated Tubing Kit 1/4" x 1/2" x 1/2" x 35'	
DL04100820	Insulated Tubing Kit 1/4" x 5/8" x 1/2" x 20'	E24RKUA, E24NKUA, CU-4KE24NBU, CU-4KE31NBU, CS-MKE24NKKU
DL04100830	Insulated Tubing Kit 1/4" x 5/8" x 1/2" x 30'	
DL04100850	Insulated Tubing Kit 1/4" x 5/8" x 1/2" x 50'	
DL06100830	Insulated Tubing Kit 3/8" x 5/8" x 1/2" x 30'	All 26,000 through 42,000 Btu/h Models
DL06100850	Insulated Tubing Kit 3/8" x 5/8" x 1/2" x 50'	All 26,000 through 42,000 Btu/h Models
CZ-26BCU1U	Fresh Air Intake Plenum	S-26PU1U6
CZ-42BCU1U	Fresh Air Intake Plenum	S-36PU1U6, S-42PU1U6
RCS5PS4B	Locking Bracket for Wireless Remote Controller	All 26,000 through 42,000 Btu/h Models except CS-KE30NKKU and CS-KE36NKKU
RCS4MHVB	Locking Bracket for Wireless Remote Controller	All KE and MKE Models
RCPTC110B	Locking Bracket for Wireless Remote Controller	All E9, 12, 18 and 24 Models, ME7 Models and XE Models
BS600	Mounting Bracket for Outdoor Unit	All Models
SI-30-120	Condensate Pump	All 115 Volt Models
SI-30-230	Condensate Pump	All 230 Volt Models (up to 2 ton)
CZ-RE2C2	Simple Wired Remote	All 26,000 through 42,000 Btu/h Models except CS-KE30NKKU and CS-KE36NKKU
CZ-RELC2	Simple Wired Remote with Backlight	
CZ-RD515U	Wired Remote Controller	All KE and MKE Models
CZ-RD516C-1	Wired Remote Controller	All E9, 12, 18 and 24 Models
CZ-RC515U	Wire Kit for Wired Remote Controller	Adaptor wire for CZ-RD515U, required for use with CS-MKE7, 9, 12, 18 and 24NKKU Models
CZ-RC515UA	Wire Kit for Wired Remote Controller	Adaptor wire for CZ-RD515U, required for use with CS-KE30NKKU and CS-KE36NKKU
CZ-RTC2	Wired Timer Remote Controller	All 26,000 through 42,000 Btu/h Models except CS-KE30NKKU and CS-KE36NKKU
CZ-RTC3	High Function Wired Timer Remote Controller	
CZ-RTC4	Wired Remote for Econavi Ducted Systems	
CZ-RD52CU	Wired Remote Controller	E12RB4U/E18RB4U
CZ-RWSK1U	Wireless Remote Controller Transmitter	S-26PK1U6
CZ-RWSU2U	Wireless Remote Controller Transmitter and Receiver Kit	S-26/36/42PT1U6, S-26/36/42PU1U6
CZ-RWSC1U	Wireless Remote Controller Transmitter and Receiver Kit	S-26/36PF1U6, S-26/36PF2U6
CZ-64ESMC1U	System Controller	All 26,000 through 42,000 Btu/h Models except CS-KE30NKKU and CS-KE36NKKU
CZ-MA1P / CZ-MA1P-US	Tube Size Reducing Adaptor, 3/8" male and 1/2" female	For CS-E12/18 Models to connect with multi-split outdoor
CZ-MA2P / CZ-MA2P-US	Tube Size Reducing Adaptor, 1/2" male and 3/8" female	For CS-E24 Models to connect with multi-split outdoor
CZ-MA3P / CZ-MA3P-US	Tube Size Reducing Adaptor, 1/2" male and 5/8" female	
CZ-SA20P	Replacement Anti-microbial Filter	All E9, 12, 18 and 24 Models and ME7 Models
CZ-FDXB	Replacement Anti-microbial Filter	CS-MKE7, 9, 12, 18, 24NKKU Models and equivalent Sanyo models
WINDB-1	Wind Baffle	All Models

Remote Controller Options for Models 26,000 BTU's and Larger

Wired Remote Controllers (Except KE30/36NKU, KS30/36NKU)

Simplified Remote Controller 	Timer Remote Controller 	System Controller 
 <p>CZ-RE2C2 CZ-REL2 (with Backlight)</p>	 <p>CZ-RTC2</p>	 <p>CZ-64ESMC1U</p>
<p>Key Features (Simple Remote):</p> <ul style="list-style-type: none"> • Thin and Easy To Read • Simple To Install and Use • Can Be Adapted for Use On All 26,000 through 42,000 Btu/h Indoor Units. • Mode • Fan Speed Control • Set Temperature • On/Off • Airflow Direction • Perfectly Suited for Applications Where Simpler Functionality is Required (ie: Hotel Rooms, Nursing Homes, Offices) 	<p>Key Features (Standard Remote/7 Day Timer):</p> <ul style="list-style-type: none"> • Thin and Easy To Read • Simple To Install and Use • Can Be Adapted for Use On All Indoor Units • Fan Speed Control • Airflow Direction • Operating Mode (Heating/Cooling/Auto/Dry/Fan) • Vacation Mode for Continued Energy Efficiencies • Full 7 Day Set-Back Functionality, With Up To 6 Time Periods/Day • Full System Diagnostic Capability (Diagnostic History Provides Immediate View of System Past and Present.) 	<p>Multiple Zone Controllers. The Air Conditioning Gateway.</p> <p>Panasonic's system and intelligent controls are the central nervous system of the conditioning system, the gateway to all data, temperature and system diagnostics and the heart and soul of conditioning.</p> <p>Key Features (System Control):</p> <ul style="list-style-type: none"> • Controls Up To 64 Units Into 4 Individualized Zones • Alarm and Operational Signal Output • Single Access Points for All Connected Wired Remotes

Wireless Remote Controllers

Wireless Remote Controller	Applicable Unit	For All Large capacity series Indoor Units
 <p>K1-series CZ-RWSK1U</p>	<p>U1-series (Ceiling Recessed Type) T1-series (Ceiling Suspended Type)</p> <p>Built-in type</p> <ul style="list-style-type: none"> • Signal receiving unit can be installed in the outer panel of indoor unit. • Control panel can be installed in the inside indoor unit.  <p>CZ-RWSU2U</p>	<p>External type</p> <ul style="list-style-type: none"> • Separate type signal receiving unit.  <p>CZ-RWSC1U</p>

Remote Controllers Functions

			Timer Remote Controller (CZ-RTC2)	System Controller (CZ-64ESMC1U)
Function	ON/OFF		●	● (Collective / Individual)
	Operation mode switch	Heating	●	● (Individual)
		Dry	●	● (Individual)
		Cooling	●	● (Individual)
		Fan	●	● (Individual)
	Temp setting		●	● (Individual)
	Fan speed setting (Hi/Me/Lo/Auto)		●	● (Individual)
	Auto flap	Auto airflow direction setting	●	●
		Arbitrary airflow direction setting	●	●*
	Sweep (Flap swing)		●	●*
Sensor temp. display		●	×	
Self-diagnostic function		●	●	
System	Central control (at hand inhibited)	×	●	
	Group control	● (Up to 8 units)	● (Up to 64 groups)	
	Concurrent use with weekly timer	●	●	
Setting Range	Cooling, dry	(°F)	65 - 86	
	Heating	(°F)	61 - 79	

●: Controllable
×: Uncontrollable

Note:
If you use both remote controller and system controller concurrently, both controllers can be used on a last-signal priority basis.

Wiring Schematics

9,000 - 24,000 Btu/h single zone, KS30/36NKUA, KE30/36NKU

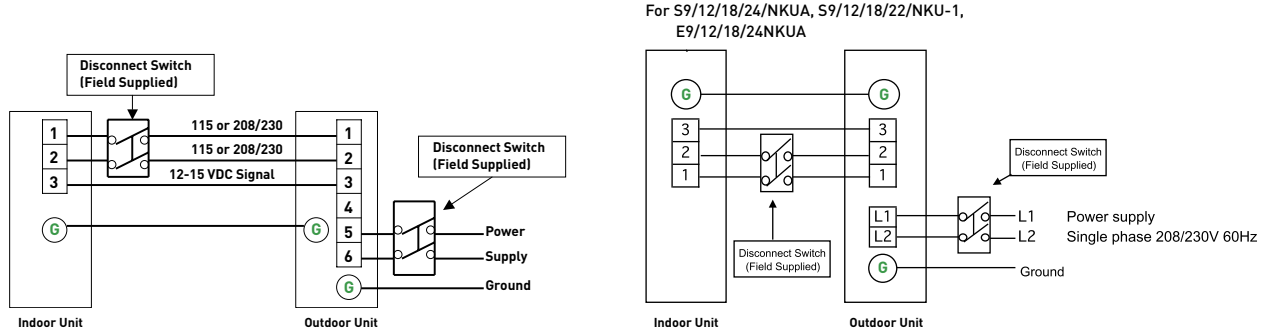

26,000 - 42,000 Btu/h single zone wiring schematic (Except KS30/36NKUA, KE30/36NKU)

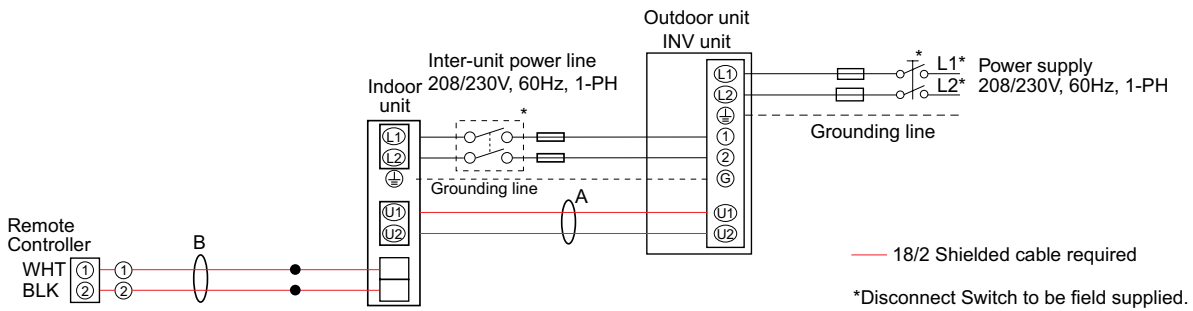

RAC Multi wiring schematic

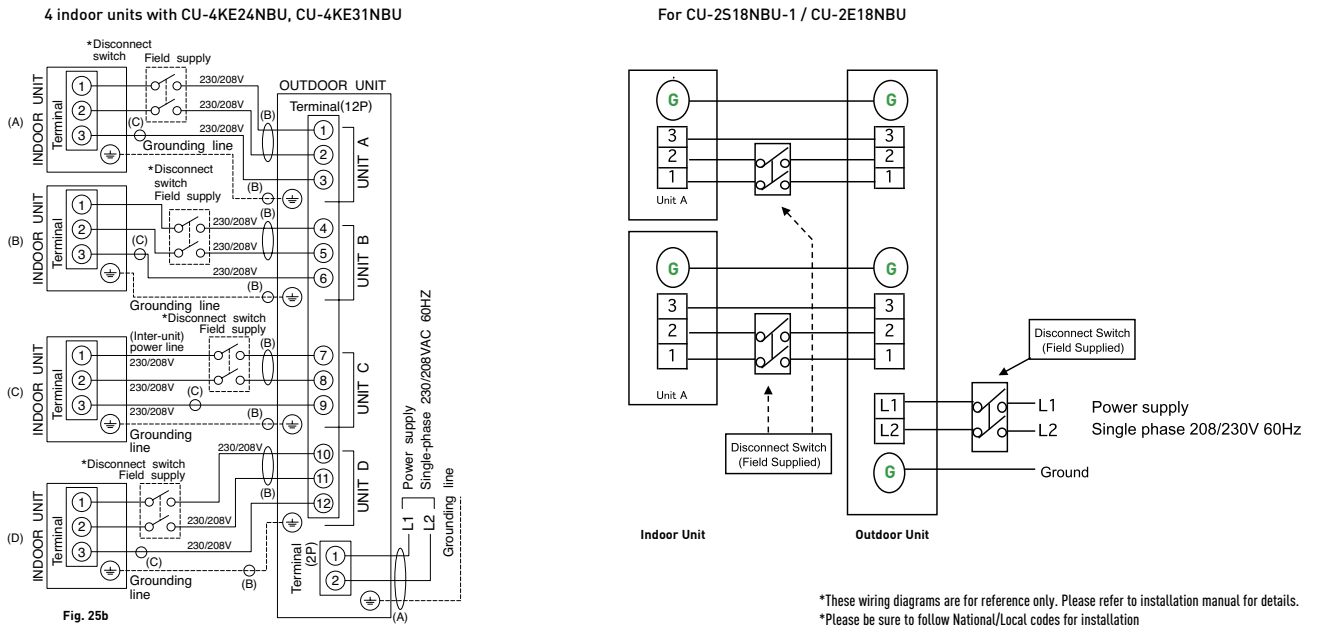

Operation Range

Cooling Models (S9/12/18/22NKU-1)

	Temperature	Indoor Air Intake Temp.	Outdoor Air Intake Temp.
Cooling	Maximum	90°F DB / 74°F WB	115°F DB
	Minimum	60°F DB / 52°F WB	60°F DB / 52°F WB

Low Ambient Cooling Models (S9/12/18/24NKUA)

	Temperature	Indoor Air Intake Temp.	Outdoor Air Intake Temp.
Cooling	Maximum	90°F DB / 74°F WB	115°F DB
	Minimum	60°F DB / 52°F WB	0°F DB(S18/24) / 5°F DB (S9/12)

Cooling Models above 26,000 Btu

	Temperature	Indoor Air Intake Temp.	Outdoor Air Intake Temp.
Cooling	Maximum	95°F DB / 71°F WB	115°F DB
	Minimum	67°F DB / 57°F WB	0°F DB

Cooling Models KS30/36NKUA

	Temperature	Indoor Air Intake Temp.	Outdoor Air Intake Temp.
Cooling	Maximum	95°F DB / 71°F WB	115°F DB
	Minimum	67°F DB / 57°F WB	0°F DB

RAC Multi KS Series Cooling Models

	Temperature	Indoor Air Intake Temp.	Outdoor Air Intake Temp.
Cooling	Maximum	95°F DB / 71°F WB	115°F DB
	Minimum	67°F DB / 57°F WB	14°F DB

RAC Multi KE Series Heating Models

	Temperature	Indoor Air Take	Outdoor Air Take
Cooling	Maximum	95°F DB / 71°F WB	115°F DB
	Minimum	67°F DB / 57°F WB	14°F WB
Heating	Maximum	80°F DB / 67°F WB	75°F DB / 65°F WB
	Minimum	60°F DB / - °F WB	0°F WB

Heat Pump Models (XE9/12PKUA)

	Temperature	Indoor Air Intake Temp.	Outdoor Air Intake Temp.
Cooling	Maximum	90°F DB / 74°F WB	115°F DB / 79°F WB
	Minimum	60°F DB / 52°F WB	0°F DB / 0°F WB
Heating	Maximum	86°F DB / - °F WB	75°F DB / 64°F WB
	Minimum	60°F DB / - °F WB	0°F DB / -2 °F WB

Heat Pump Models (E9/12/18/24NKUA)

	Temperature	Indoor Air Intake Temp.	Outdoor Air Intake Temp.
Cooling	Maximum	90°F DB / 74°F WB	115°F DB
	Minimum	60°F DB / 52°F WB	5°F DB(E18/24) / 5°F DB (E9/12)
Heating	Maximum	86°F DB / - °F WB	75°F DB / 64°F WB
	Minimum	60°F DB / - °F WB	5°F DB / - °F WB

Heat Pump Models above 26,000 Btu

	Temperature	Indoor Air Intake Temp.	Outdoor Air Intake Temp.
Cooling	Maximum	95°F DB / 71°F WB	115°F DB
	Minimum	64°F DB / 57°F WB	0°F DB
Heating	Maximum	86°F DB / 67°F WB	75°F DB / 65°F WB
	Minimum	61°F DB / - °F WB	-4°F DB

Heat Pump Models KE30/36NKU

	Temperature	Indoor Air Intake Temp.	Outdoor Air Intake Temp.
Cooling	Maximum	95°F DB / 71°F WB	115°F DB
	Minimum	67°F DB / 57°F WB	14°F DB
Heating	Maximum	80°F DB / 67°F WB	75°F DB / 65°F WB
	Minimum	60°F DB / - °F WB	0°F DB

Sanyo to Panasonic Cross Reference

* H/P: Heat Pump, C/O: Cooling Only

PAC Outdoor 2 types / 10 models

Category	Capacity Kbtu/h	Model No.	Model No.	
PAC-i (Split)	H/P	26	CH2672R	U-26PE1U6
		36	CH3672R	U-36PE1U6
		42	CH4272R	U-42PE1U6
	C/O	30	CH3082	CU-KE30NKU
		36	CH3682	CU-KE36NKU
		26	C2672R	U-26PS1U6
C/O	36	C3672R	U-36PS1U6	
	42	C4272R	U-42PS1U6	
	30	C3082	CU-KS30NKUA	
	36	C3682	CU-KS36NKUA	

PAC Indoor 5 types / 15 models (13 models, Panel : 2 models)

Category	Capacity Kbtu/h	Model No.	Model No.	
4-Way Cassette	H/P	26	XHW2672R	S-26PU1U6
		36	XHW3672R	S-36PU1U6
		42	XHW4272R	S-42PU1U6
	Panel	PNR-XH2442	CZ-24KPU1U	
		PNR-XH3642	CZ-36KPU1U	
Wall Mount	H/P	26	KHS2672R	S-26PK1U6
Wall Mount	C/O	36	KS3082	CS-KS30NKU
		42	KS3682	CS-KS36NKU
	H/P	30	KHS3082	CS-KE30NKU
		36	KHS3682	CS-KE36NKU
Ceiling Suspended	H/P	26	THW2672R	S-26PT1U6
		36	THW3672R	S-36PT1U6
		42	THW4272R	S-42PT1U6
Duct	H/P	26	UHW2672R	S-26PF1U6
		36	UHW3672R	S-36PF1U6

RAC (37 models)

Category	Capacity Kbtu/h	Model No.	Model No.	
Mini Cassette	12	XS1271	CS-KS12NB41	
	Panel	PNR-XS1872	CZ-18BT1U	
Outdoor Unit	Inv C/O	12	CL1271	CU-KS12NK1A
		18	C1872	CU-KS18NKU
		18	CL1872	CU-KS18NKUA
		24	C2472	CU-KS24NKU
		24	CL2472	CU-KS24NKUA
		12	XHS1271	CS-KE12NB41
Mini Cassette	Inv H/P	18	XHS1872	CS-KE18NB4UW
		Panel	PNR-XS1872	CZ-18BT1U
Outdoor Unit		12	CH1271	CU-KE12NK1
Wall Mount	Flexi Multi C/O	7	KMS0772	CS-MKS7NKU
		9	KMS0972	CS-MKS9NKU
		12	KMS1272	CS-MKS12NKU
		18	KMS1872	CS-MKS18NKU
		24	KMS2472	CS-MKS24NKU
Mini Cassette	Flexi Multi C/O	9	XMS0972	CS-MKS9NB4U
		12	XMS1272	CS-MKS12NB4U
Outdoor Unit	Flexi Multi C/O	Panel	PNR-XS1872	CZ-18BT1U
		19	CM1972A	CU-3KS19NB4U
		24	CM2472A	CU-4KS24NB4U
		31	CM3172A	CU-4KS31NB4U
		7	KMS0772	CS-MKE7NKU
Wall Mount	Flexi Multi H/P	9	KMS0972	CS-MKE9NKU
		12	KMS1272	CS-MKE12NKU
		18	KMS1872	CS-MKE18NKU
		24	KMS2472	CS-MKE24NKU
		9	XMS0972	CS-MKE9NB4U
		12	XMS1272	CS-MKE12NB4U
Mini Cassette	Flexi Multi H/P	Panel	PNR-XS1872	CZ-18BT1U
		19	CMH1972A	CU-3KE19NB4U
Outdoor Unit	Flexi Multi H/P	24	CMH2472A	CU-4KE24NB4U
		31	CMH3172A	CU-4KE31NB4U
		31	CMH3172A	CU-4KE31NB4U

Controllers

Category	Common	Model No.	Model No.
Wireless RC	4-Way	RCS-BH80AAB.WL	CZ-RWSC1U
	Wall Mount	RCS-SH80AAB.WL	CZ-RWSU1U
		RCS-SH1AAB	CZ-RWSK1U
System Controller		SHA-KC64UG	CZ-64ESMC1U
Simple Remote		RCS-KR1EG	CZ-REZC2
Simple Wired RC		NEW	CZ-REL2C
Wireless RC	U1/T1 Series	RCS-SH80UA.WL	CZ-RWSU2U
Wired Kit		STK-KCW1	CZ-RC515U
		STK-KCW2	CZ-RC515UA
Wired RC		STK-RCS-7TWSUA	CZ-RD515U

Accessories

Category	Model No.	Model No.	
Fresh Air intake	4-Way	CMB-GSJ80U	CZ-26BCU1U
	4-Way	CMB-GSJ140U	CZ-42BCU1U
Outdoor Bracket		STK-KSB2050	CZ-12UD1U
		STK-KSB5050	CZ-30UD1U

Rating Conditions

	Cooling	Heating
Inside air temperature	80°F DB / 67°F WB	70°F DB / 60°F WB
Outside air temperature	95°F DB (75°F WB)	47°F DB / 43°F WB

Tubing Sizes, Lengths and Elevation Differences, Refrigerant Charge Adjustment and Insulation Chart

SYSTEM MODEL	OD Tube Size (inch)		Maximum Length of Tubing between In/Outdoor	Maximum Elevation Difference (ft) between In/Outdoor		Maximum Length (ft) without Adding Refrigerant	Required Additional Refrigerant Oz/ft	Insulation					
	Narrow	Wide		Outdoor Above	Outdoor Below								
XE9PKUA	1/4"	3/8"	66'	49'	49'	25'	R410A 0.2	Both Tubes					
E9RKUA													
E9NKUA													
XE12PKUA		1/2"							100'	49'	49'	33'	R410A 0.3
E12RKUA													
E12NKUA													
E12RB4U													
E18RKUA													
E18NKUA													
E18RB4U		5/8"	165'	100'	50'	100'	R410A 0.43						
E24RKUA													
E24NKUA													
26PEK1U6	3/8"	5/8"						165'	100'	50'	100'	R410A 0.43	
26PET1U6													
26PEU1U6													
26PEF1U6													
KS30NKUA													
KE30NKU													
KS36NKUA		165'						100'	50'	100'	R410A 0.43		
KE36NKU													
36PET1U6													
36PEU1U6													
36PEF1U6													
42PET1U6													
42PEU1U6													
CU-2E18NBU	1/4"	3/8"*1	82'	49'	25'	65'	R410A 0.2						
CU-3KE19NBU		3/8"		50'	50'		150'	R410A 0.22					
CU-4KE24NBU		3/8"x3, 1/2"x1	100'			R410A 0.2							
CU-4KE31NBU		3/8"x2, 1/2"x2	82'	49'	25'	R410A 0.2							
CU-5E36QBU		3/8"*1											

* 1 Reducing adaptor may be required depending on indoor model to be used with. (CZ-MA1P, CZ-MA2P or CZ-MA3P)

Model Identification

RAC

Indoor Unit

C S - S 18 N K U -1
1 2 3 4 5 6 7 8 9

Outdoor Unit

C U - S 18 N K U -1
1 2 3 4 5 6 7 8 9

Set

S 18 N K U -1
3 4 5 6 7 8 9

1 Series	2 Model/Type	3 Connection configuration	4 Function	5 Capacity	6 Development	7 Category (Type)	8 Voltage	9 Others
C: Residential	S: Indoor unit U: Outdoor unit	X: Deluxe type K/None: Internal purpose MK: Indoor unit for Multi zone Connected Type (Multi-zone) Numeral: Numeral+K	S: Cooling only E: Heat pump	Cooling Capacity in BTU/h	Development Series No.	K: Wall Mount B6: Mini Ceiling Recessed K: Internal	U: 208/230V, 60Hz 1: 115V, 60Hz	-1: Non-Low Ambient W: Multi/Single Zone common use -1: Non-Low Ambient

PAC

Indoor Unit

S - 26 P U 1 U6
1 2 3 4 5 6

Outdoor Unit

U - 36 P S 1 U6
1 2 3 4 5 6

Set

26 P S 1 U6
2 3 4 5 6

1 Model/Type	2 Capacity	3 Series	4 Category (Function)	5 Development	6 Voltage
S: Indoor unit U: Outdoor Unit	Cooling Capacity in BTU/h	P: Large Capacity series	K: Wall Mount U: Ceiling Recessed T: Ceiling suspended F: Concealed Duct S: Cooling Only H: Heat Pump	Development Series	U6: 208/230V 60Hz

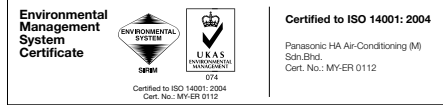
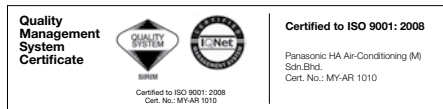

Serving the US Ductless market since 1983

Panasonic

Panasonic Corporation of North America
Panasonic Appliances Air-Conditioning North America
1690 Roberts Blvd., NW, Suite 110, Kennesaw, GA 30144 U.S.A.
us.panasonic.com/aircon

Panasonic Canada Inc.
Enterprise Product Sales
5770 Ambler Dr., Mississauga, ON, L4W 2T3 CANADA
www.panasonic.ca

Warranty - 7 years compressor/5 years parts

Because its products are subject to continuous improvements, Panasonic reserves the right to modify product design and specifications without notice and without incurring any obligations.
©Copyright 2012, Panasonic Air Conditioning Products.



Caution Related to Safety

Do not add or replace refrigerant other than the specified type. Manufacturer is not responsible for the damage and deterioration in safety due to usage of other refrigerant.