

CONDENSING TANKLESS GAS WATER HEATER



Installation Manual

Models

NRCP1112-DV / NRCP982-DV (Eco TOUGH)

• Natural Gas(NG) / Liquid Propane Gas (LP)



Low NO_x Approved
by SCAQMD
14ng/J or 20ppm
(Natural Gas Only)



Thank you for purchasing this Noritz Tankless Gas Water Heater.

Before using, please:

Read this guide completely for operation instructions.

Completely fill out the warranty registration card (included separately) and mail the detachable portion to Noritz America Corporation. Keep this guide (and the remainder of the warranty registration card) where it can be found whenever necessary.

Installation must conform with local codes, or in the absence of local codes, the National Fuel Gas Code, ANSI Z223.1/NFPA 54. Noritz America reserves the right to discontinue, or change at any time, the designs and/or specifications of its products without notice.

WARNING

If the information in these instructions is not followed exactly, a fire or explosion may result, causing property damage, personal injury, or death.



- Do not store or use gasoline or other flammable vapors and liquids in the vicinity of this or any other appliance.
- WHAT TO DO IF YOU SMELL GAS
 - Do not try to light any appliance.
 - Do not touch any electrical switch; do not use any phone in your building.
 - Immediately call your gas supplier from a neighbor's phone. Follow the gas supplier's instructions.
 - If you cannot reach your gas supplier, call the fire department.
- Installation and service must be performed by a qualified installer, service agency or the gas supplier.

<u>Chapter 1</u>	Product Accessories	1-1 Included Accessories	3
		1-2 Optional Accessories	3
<u>Chapter 2</u>	Product Specifications	2-1 Specifications	4
		2-2 Dimensions & Connections	5
<u>Chapter 3</u>	Safety Requirements	3-1 Safety Precautions	6
		3-2 Before Installation	7
		3-3 Choosing Installation Site	8
		3-4 High Elevation Installations	9
		3-5 Installation Clearance	10
<u>Chapter 4</u>	Installation	4-1 Securing to the wall	13
		4-2 Vent Pipe Installation	14
		4-3 Gas Piping	20
		4-4 Water Piping	23
		4-5 Condensate Piping	25
		4-6 Plumbing Application	26
		4-7 Electrical Wiring	30
		4-8 Setting the Control Panel	31
		(Clock Adjustment & Recirculation Timer Setting, High Elevation Setting)	
		4-9 Quick Connect Multi System Installation	35
4-10 Common Vent	37		
<u>Chapter 5</u>	Maintenance	5-1 Maintenance	39
		5-2 Final Check List	41
	Memo	42	

Chapter 1. – Product Accessories



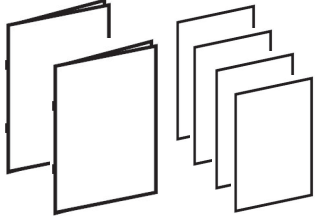
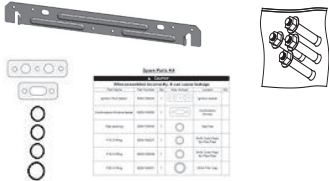



1-1. Included Accessories

The following accessories are included with the unit. Check for any missing items before starting installation.

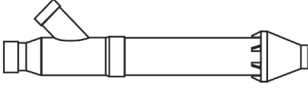
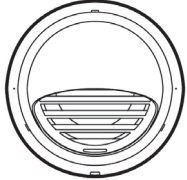
Part	Shape	Q'ty	Part	Shape	Q'ty
Water Heater		1	Owner's Guide, Warranty Card, Installation Manual, Technical Data Sheet, Quick Installation Guide, Part List		1 each
Anchors / Wall mounting bracket / Emergency Kit		1 each	Vent screens with Finishing (3")		2

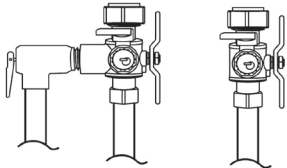
1-2. Optional Accessories

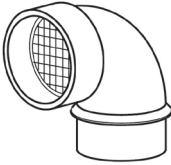
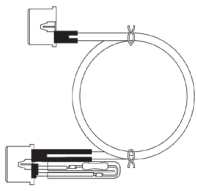
The accessories listed below are not included with the unit, but may be necessary for installation.

Part	Shape	Q'ty	Part	Shape	Q'ty
PVC Terminal VK3-H-PVC		1	Horizontal Hood Termination PVT-HL		1 each
VK3-PVC-VAS		1	Isolation Valves (includes pressure relief valve)		1 each
PVC Terminal PRC-1		1	Vent screens with Finishing (2") (After market)		2
SV Conversion Kit (#SV-CK-3) •90 Elbow (With Inlet Screen)		1	Quick Connect Cord QC-NRCP		1
Neutralizer (NC-1) (For 1 water heater)		1			

2-1. Specifications Specifications may be changed without prior notice. The capacity may differ slightly, depending on the water pressure, water supply, piping conditions, and water temperature.

Model Name		NRCP1112-DV		NRCP982-DV		
Gas Input Rate	MAX	199,000 Btu/h		180,000 Btu/h		
	MIN	18,000 Btu/h		18,000 Btu/h		
	High Altitude (2,500~4,500ft)	180,000 Btu/h		180,000 Btu/h		
Hot Water Capacity	35°F Rise	11.1 Gal		10.1 Gal		
	45°F Rise	8.7 Gal		7.8 Gal		
	77°F Rise	5.1 Gal		4.6 Gal		
Installation		Indoor Wall Hung				
Flue System		Sealed Combustion Direct Vent, Single Vent				
Max Vent Run		2"(50ft) / 3"(100ft) Schedule 40 PVC, CPVC, PP				
Orifice Size	NG (Gas / Needle)	0.381"(9.7mm) / 0.389"(9.9mm)				
	LP (Gas / Needle)	0.307"(7.8mm) / 0.315"(8.0mm)				
Gas Supply Pressure	NG	3.5" WC to 10.5" WC				
	LP	8.0" WC to 14" WC				
Manifold Pressure	Gas Type		NG	LP	NG	LP
	Low Fire	2" VENT	-0.03 WC	-0.06 WC	-0.03 WC	-0.06 WC
		3" VENT	-0.03 WC	-0.06 WC	-0.03 WC	-0.06 WC
	High Fire	2" VENT	-0.04 WC	-0.07 WC	-0.04 WC	-0.07 WC
3" VENT		-0.04 WC	-0.07 WC	-0.04 WC	-0.07 WC	
Power Supply	Main Supply		120V 60Hz			
	Maximum Power Consumption		172W(82W+90W_PUMP)			
Ignition System		Direct Electronic Ignition / Automatic Flame Sensing				
Burner System		Premixed Metal Fiber Burner				
Gas Valve System		Air ratio valve				
Minimum Flow Activation Flow		0.5 GPM				
Internal Pipe Material		STS 304, Copper Tubing				
Dimensions		W17.3" – H28.7" – D14.8"				
Weight		85 lbs				
Water Holding Capacity		Under 2 Gallon				
Control Panel / Main Controller		P-950C / NGTH-9700C				
Water Pressure	MAX	Hot water 150 psi				
	MIN	15 psi				
Materials	Casing	Cold Rolled Carbon Steel				
	Heat Exchanger	Heat Exchanger : STS 304				
Safety Devices		Flame Sensor, Overheat Cut Off Limit Switch , Gas Leak Detector sensor, Water Leak Detector Sensor Exhaust Temperature Sensor, Water Temperature Sensor				

2-2. Dimensions & Connections

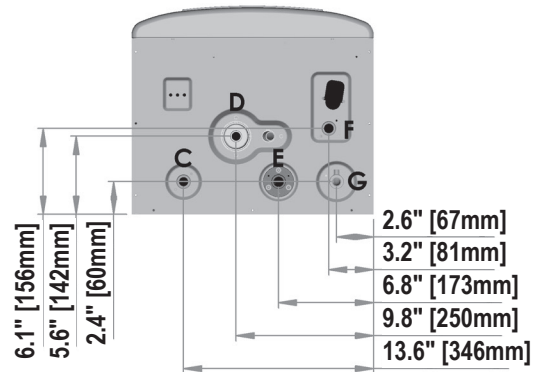
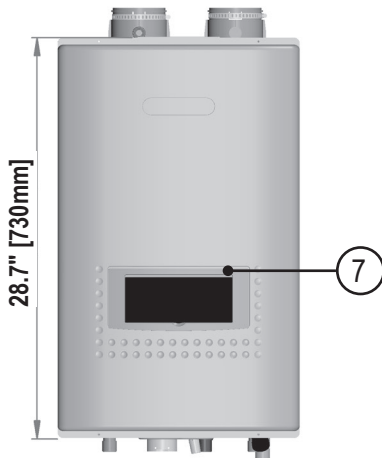
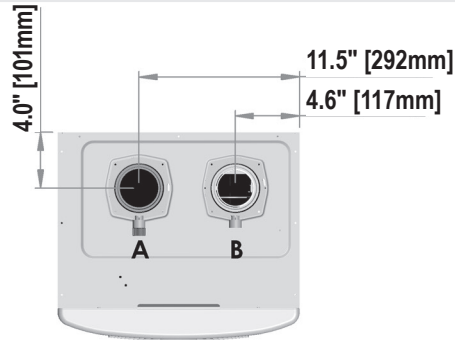

	Description	Size
A	Exhaust	3"
B	Air Intake	3"
C	Hot Water	3/4"
D	Condensate	1/2"
E	Recirculation Return	3/4"
F	Cold Water	3/4"
G	Gas	3/4"

NO	Name of Component
1	Exhaust
2	Igniter
3	Ignition Plug
4	Burner High Limit Switch
5	Primary Heat Exchanger
6	Secondary Heat Exchanger
7	Control Panel
8	Water Mixing Valve
9	Recirculation Pump
10	Hot Water Connection
11	Condensate Trap
12	Recirculation Return Connection with Filter
13	Computer Board
14	Cold Water Connection
15	Cold Water Filter
16	Gas Connection
17	Manual Power Switch
18	Flow Sensor
19	Water Control Valve
20	Air Pressure Switch
21	Flame Sensor
22	Gas Valve
23	AGM (Air Gas Mixer)
24	Fan Motor
25	Internal Air Intake Filter
26	Air Intake

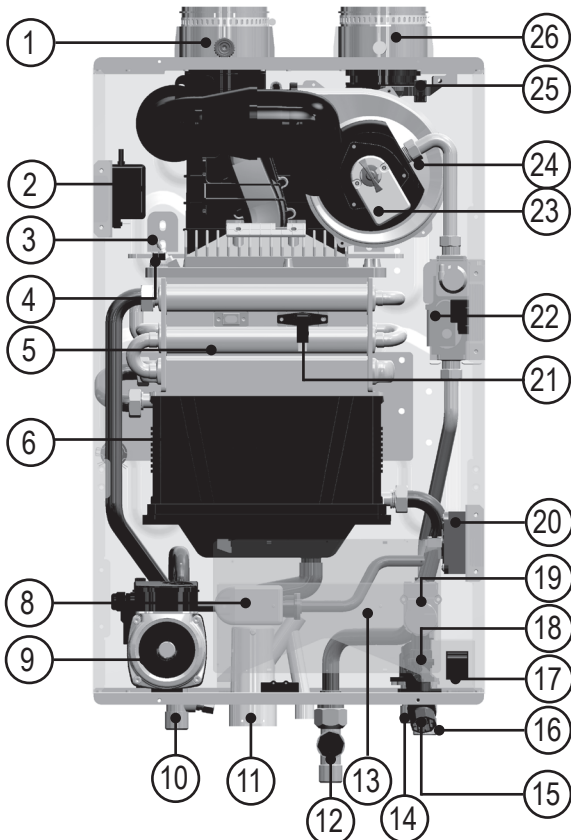

3-1. Safety Precautions

WARNING

To avoid product damage, personal injury, or even possible death, carefully read, understand, and follow all the instructions in the Installation and Owner's Guide before installation, operation and service the Water Heater.

Noritz cannot anticipate every circumstance that might involve a potential hazard. Therefore, all possible incidents are not included in our warnings. Proper installation, operation, and service are your responsibility.

You must make sure that the operation and settings of the Water Heater are safe for you and for others.

This manual provides Safety Symbols. When the user fails to adhere to the following requirement, it will cause death, serious damages, and a great property loss.

For safety symbols, 'DANGER', 'WARNING', 'CAUTION' are indicated and the definitions for these terms are as follow:

DANGER

Indicates an imminently hazardous situation which, if not avoided, will result in death or serious injury. This signal word is limited to the most extreme situations.

WARNING

Indicates a potentially hazardous situation which, if not avoided, could result in death or serious injury.

CAUTION

Indicates a potentially hazardous situation which, if not avoided, may result in minor or moderate injury. It is also used to alert against unsafe practices and hazards involving only property damage.

3-2. Before Installation

DANGER

Check the fixing brackets and vent pipe yearly for damage or wear. Replace if necessary.

WARNING

Precautions on Vent Pipe Replacement

The vent system will almost certainly need to be replaced when this appliance is being installed. Only use vent materials that are specified in this Installation Manual for use on this appliance. Refer to the “Vent Pipe Installation” section for details. If PVC, CPVC, or Category IV listed pipe is already installed, check for punctures, cracks, or blockages and consult with the vent pipe manufacturer before reusing.

Improper venting may result in fires, property damage or exposure to Carbon Monoxide.

Snow Precaution

If this product will be installed in an area where snow is known to accumulate, protect the vent termination from blockage by snow drifts or damage from snow falling off of roofs.

Check the Gas

Check that the rating plate indicates the correct type of gas.
Check that the gas supply line is sized for 199,000 Btu/h.

Check the Power

The power supply required is 120VAC, at 60Hz.
Using the incorrect voltage may result in fire or electric shock.

CAUTION

Do Not Use Equipment for Purposes Other Than Those Specified.

Do not use for other than increasing the temperature of the water supply, as unexpected accidents may occur as a result.

Check Water Supply Quality

If the water supply is in excess of 12 grains per gallon (200 mg/L) of hardness, acidic or otherwise impure, treat the water with approved methods in order to ensure full warranty coverage.

3-3. Choosing Installation Site

Locate the appliance in an area where leakage from the unit or connections will not result in damage to the area adjacent to the appliance or to the lower floors of the structure. When such locations cannot be avoided, it is required that a suitable drain pan, adequately drained, be installed under the appliance.

The pan must not restrict combustion air flow.

⚠ DANGER

Locate the vent terminal so that there are no obstacles around the termination and so that exhaust can't accumulate. Do not enclose the termination with corrugated metal or other materials.

⚠ WARNING

Avoid places where fires are common, such as those where gasoline, benzene and adhesives are handled, or places in which corrosive gases (ammonia, chlorine, sulfur, ethylene compounds, acids) are present. Using the incorrect voltage may result in fire or cracking.

Avoid installation in places where dust or debris will accumulate. Dust may block the air-supply opening, causing the performance of the device fan to drop and incomplete combustion to occur as a result.

Avoid installation in places where special chemical agents (e.g., hair spray or spray detergent) are used. Ignition failures and malfunction may occur as a result.

Carbon Monoxide Poisoning Hazard. Do not install this water heater in a mobile home, recreational vehicle or on a boat.

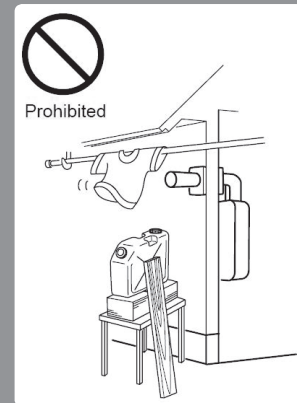

⚠ CAUTION

The water heater is designed for indoor installation only. Never install it outdoors or in a bathroom, it may be damaged or a fire may be caused.

Consult with the customer concerning the location of installation.

Install the water heater in an area that allows for the proper clearances to combustible and noncombustible construction. Consult the rating plate on the appliance for proper clearances.

Do not install the water heater in a place where it may be threatened by falling objects, such as under shelves.

The water heater must be installed in a place where supply and exhaust pipes can be installed as directed.

Do not install the water heater where the exhaust will blow on outer walls or material not resistant to heat. Also consider the surrounding trees and animals.

The heat and moisture from the water heater may cause discoloration of walls and resinous materials, or corrosion of aluminum materials.

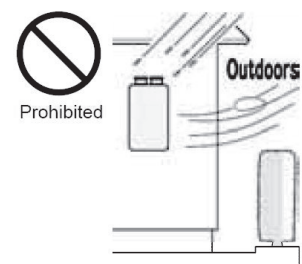

⚠ CAUTION

Avoid installation above gas ranges or stoves.

Avoid installation between the kitchen fan and stove. If oily fumes or a large amount of steam are present in the installation location, take measures to prevent the fumes and steam from entering the equipment.

Install the unit in a location where the exhaust gas flow will not be affected by fans or range hoods.

Take care that noise and exhaust gas will not affect neighbors. Avoid installation on common walls as the unit will make some operational noises while it is running.

Before installing, make sure that the exhaust flue termination meets clearance requirements proper clearances according to the National Fuel Gas Code (ANSI Z223.1).

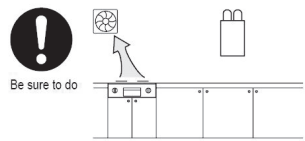
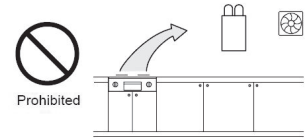

State of California:

The water heater must be braced, anchored or strapped to avoid moving during an earthquake. Contact local utilities for code requirements in your area or call: 1-866-766-7489 and request instructions.

3-4. High Elevation Installations

- This unit is only ANSI/CSA certified for installation up to 4500 ft. (1,350 m) above sea level.
- For installations at higher elevations, please refer to the directions below or contact Noritz America.

Note:

This water heater may be installed at elevation up to 10,000 ft for use with Natural Gas and Propane. The water heater must be set for a specific altitude using the Installer Mode Setting described below.

Above 2,000 ft (610 m), the water heater will de-rate by 4% for each 1,000 ft (305 m) of altitude gain.

[Installer Mode]

Display	Operation	Description
5:EL	High Elevation	Select an altitude range from the following four options based on where the water heater is installed.
0 ~ 2	Default	0 ~ 1,999 ft (0 ~ 609 m)
2 ~ 5		2,000 ~ 4,999 ft (610 ~ 1,523 m)
5 ~ 8		5,000 ~ 7,999 ft (1,524 ~ 2,438 m)
8 ~ 10		8,000 ~ 10,000 ft (2,439 ~ 3,048 m)

* Please refer to page 34 for more detail setting method on control panel.

3-5. Installation Clearances

⚠ WARNING

Before installing, check for the following:

Install in accordance with relevant building and mechanical codes, as well as any local, state or national regulations, or in the absence of local and state codes, to the National Fuel Gas Code ANSI Z223.1/ NFPA 54 – latest edition. In Canada, see NSCNGPIC for detailed requirements.

Distance from combustibles

Maintain the following clearances from both combustible and non-combustible materials.

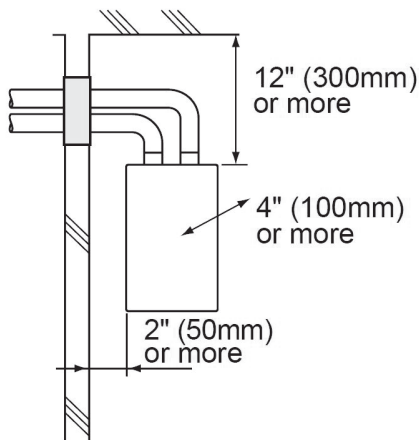

Cooking Equipment

<When the indoor air supply>

- If the unit will be installed in the vicinity of a permanent kitchen range or stove that has the possibility of generating steam that contains fats or oils, use a dividing plate or other measure to ensure that the unit is not exposed to air containing such impurities.

* The dividing plate should be of noncombustible material of a width greater than the water heater.

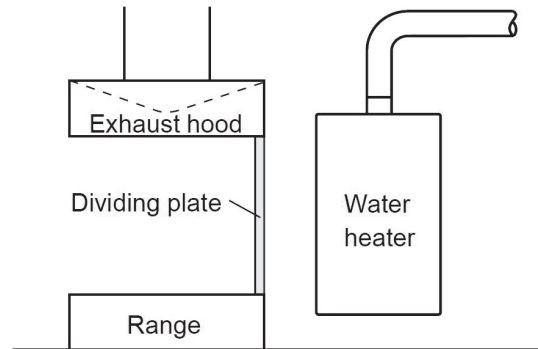

Securing of space for repair/inspection

If possible, leave 8" (200mm) or more on either side of the unit to facilitate inspection.

If possible, leave 24" (600mm) or more in front of the unit to facilitate maintenance and service if necessary.

If possible, leave 3" (75mm) or more above and below the vent pipe to facilitate inspection and repair if necessary

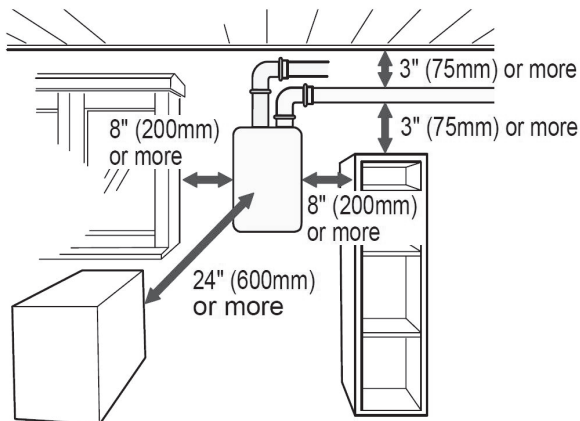

**Clearance Requirements from Vent Terminations to Building Openings
<When supplying combustion air from the outdoors (Direct Vent)>**

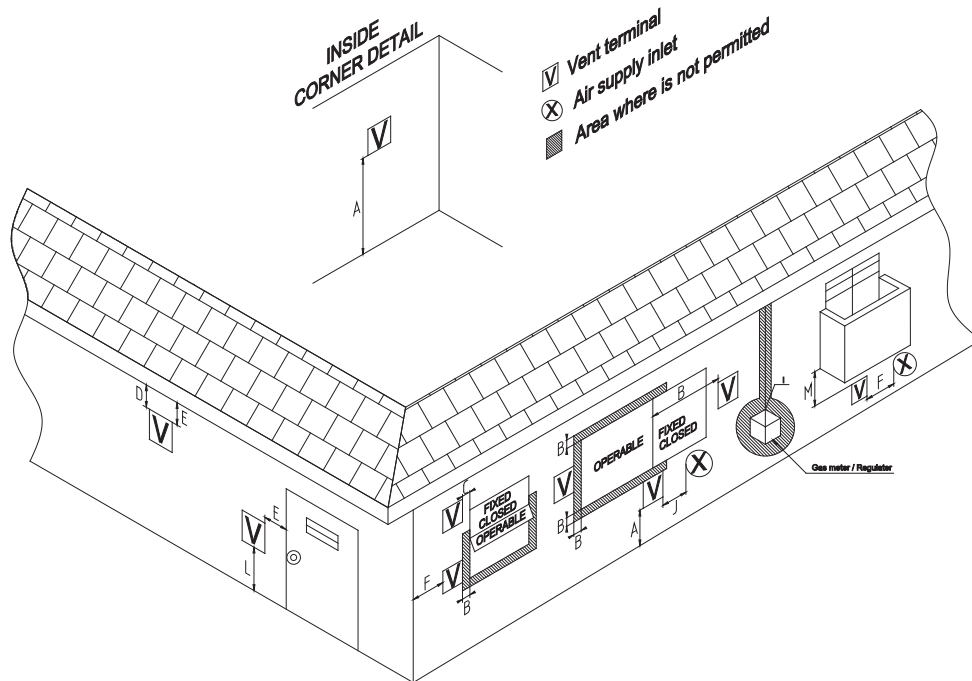

	Description	US Direct Vent Installations ¹	Canadian Direct Vent Installations ²
A	Clearance above grade, veranda, porch, deck, or balcony	12 in (30 cm)	12 in (30 cm)
B	Clearance to window or door that may be opened	12 in (30 cm)	36 in (91 cm)
C	Clearance to permanently closed window	*	*
D	Vertical clearance to ventilated soffit located above the terminal within a horizontal distance of 2 feet from the center line of the terminal	*	*
E	Clearance to unventilated soffit	*	*
F	Clearance to outside corner	*	*
G	Clearance to inside corner	*	*
H	Clearance to each side of center line extended above meter/regulator assembly	*	3 ft (91 cm) within a height 15 ft above the meter/regulator assembly
I	Clearance to service regulator vent outlet	*	3 ft (91 cm)
J	Clearance to non-mechanical air supply inlet to building or the combustion air inlet to any other appliance	12 in (30 cm)	36 in (91 cm)
K	Clearance to a mechanical air supply inlet	3 ft (91 cm) above if within 10 ft (3 m) horizontally	6 ft (1.83 m)
L	Clearance above paved sidewalk or paved driveway located on public property	*	7 ft (2.13 m) †
M	Clearance under veranda, porch, deck, or balcony	*	12 in (30 cm) ‡

¹ In accordance with the current CSA B149.1 Natural Gas and Propane Installation Code

² In accordance with the current ANSI Z223.1 / NFPA 54 National Fuel Gas Code

† A vent shall not terminate directly above a sidewalk or paved driveway that is located between two single family dwellings and serves both dwellings.

‡ Permitted only if veranda, porch, deck, or balcony is fully open on a minimum of two sides beneath the floor.

* Clearance in accordance with local installation codes and the requirements of the gas supplier. Clearance to opposite wall is 24 inches (60 cm).

**Clearance Requirements from Vent Terminations to Building Openings
<When supplying combustion air from the indoors (Non-Direct Vent)>**

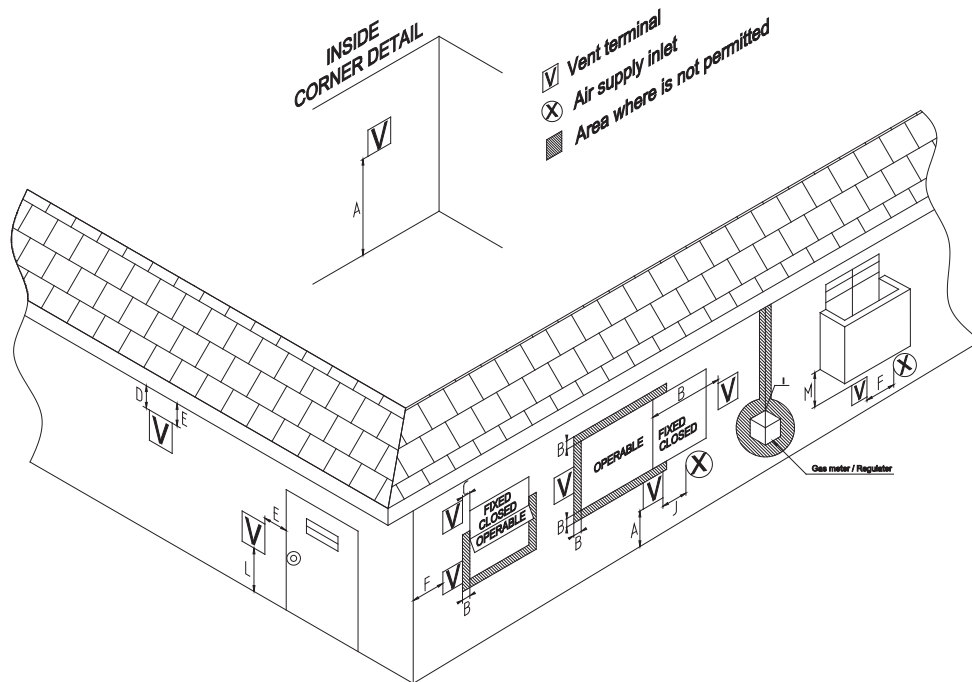

	Description	US Non-Direct ¹	Canadian Non-Direct ²
A	Clearance above grade, veranda, porch, deck, or balcony	12 in (30 cm)	12 in (30 cm)
B	Clearance to window or door that may be opened	48 in (120 cm) below or to side of opening; 12 in (30 cm) above opening	36 in (91 cm)
C	Clearance to permanently closed window	*	*
D	Vertical clearance to ventilated soffit located above the terminal within a horizontal distance of 2 feet from the center line of the terminal	*	*
E	Clearance to unventilated soffit	*	*
F	Clearance to outside corner	*	*
G	Clearance to inside corner	*	*
H	Clearance to each side of center line extended above meter/regulator assembly	*	36 in (91 cm) within a height 15 ft (4.57 m) above the meter/ regulator assembly
I	Clearance to service regulator vent outlet	*	36 in (91 cm)
J	Clearance to non-mechanical air supply inlet to building or the combustion air inlet to any other appliance	48 in (120 cm) below or to side of opening; 12 in (30 cm) above opening	36 in (91 cm)
K	Clearance to a mechanical air supply inlet	36 in (91 cm) above if within 10 ft (3 m) horizontally	6 ft (1.83 m)
L	Clearance above paved sidewalk or paved driveway located on public property	*	7 ft (2.13 m) †
M	Clearance under veranda, porch, deck, or balcony	*	12 in (30 cm) ‡

¹ In accordance with the current CSA B149.1 Natural Gas and Propane Installation Code

² In accordance with the current ANSI Z223.1 / NFPA 54 National Fuel Gas Code

† A vent shall not terminate directly above a sidewalk or paved driveway that is located between two single family dwellings and serves both dwellings.

‡ Permitted only if veranda, porch, deck, or balcony is fully open on a minimum of two sides beneath the floor.

* Clearance in accordance with local installation codes and the requirements of the gas supplier. Clearance to opposite wall is 24 inches (60 cm).

4-1. Securing to the wall

WARNING

CLEARANCES FOR SERVICE ACCESS

The water heater must be installed on a wall that can bear its weight.

If you try to install the heater on a wall which cannot support its weight, please reconsider.

The Water heater can be installed on any suitable internal wall (suitable sound proofing may be required when installing onto a stud partition wall).

Method of positioning the water heater on a wall

- Drill in the supplied anchor screws after considering where the vent termination will be located.
- After four anchor screws are inserted in the holes, mount the wall bracket.
- Affix the wall bracket securely to the wall.
- Make sure that it is leveled, and it can support the weight of the water heater.

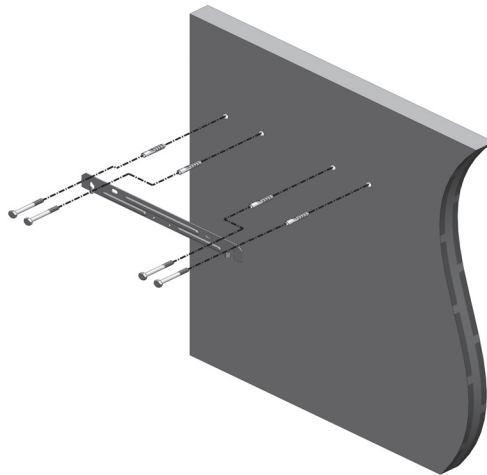

- Lift up the water heater, rest the unit on the hooks provided on the wall bracket on the wall.

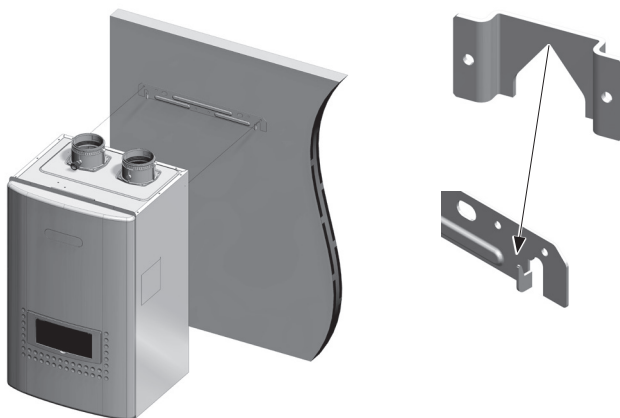

4-2. Vent Pipe Installation (Indoor Installation Only)

■ General Requirements

- Under normal conditions, this appliance will not produce an exhaust flue temperature in excess of 149°F (65°C) and schedule 40 PVC pipe may be used as the vent material. If the water heater set temperature is 160°F (70°C) or higher and there is a return line to the water heater from either a recirculation pump, schedule 40 CPVC must be used.
- Make sure the vent system is gas tight and will not leak.
- Support the vent pipe with hangers at regular intervals as specified by these instructions or the instructions of the vent manufacturer.
- Do not common vent or connect more than one appliance to this venting system.
- The total vent length including horizontal & vertical vent runs should be no less than 3' (0.9m).
- Do not store hazardous or flammable substances near the vent termination and check that the termination is not blocked in any way.

■ Venting With PVC or CPVC

This appliance can be vented with non cellular core plastic pipe materials as specified in the below table. Vent installations in Canada which utilize plastic vent systems must comply with ULC S636.

Item	Material	United States	Canada
Exhaust Vent /Air Intake	Schedule 40 PVC	ANSI/ASTM D1785	ULC S636 Certified Materials Only
	PVC-DWV	ANSI/ASTM D2665	
	Schedule 40 CPVC	ANSI/ASTM F441	
Pipe Cement/Primer	PVC	ANSI/ASTM D2564	
	CPVC	ANSI/ASTM F493	
Note: Do Not Use Cellular Foam Core Pipe			

- Use only solid PVC or CPVC schedule 40 pipe. Cellular foam core piping is not allowed.
- In Canada, plastic vent systems must be certified to ULC S636. The components of the certified vent system must not be interchanged with other vent systems or unlisted pipe/fittings.
- In Canada, specified primers and glues of the ULC S636 certified vent system must be from a single system manufacturer and not intermixed with other system manufacturer's vent system parts.
- PVC or CPVC pipe has been approved for use on this appliance with zero clearance to combustibles.
- Follow all general venting guidelines as outlined on this page.
- The pipe shall be installed so that the first 3' (0.9m) of pipe from the appliance flue outlet is readily accessible for visual inspection.
- When preparing and assembling the pipe, follow instructions as provided by the pipe manufacturer. In general, the following practices must be observed:
 - * Squarely cut all pieces of pipe.
 - * Remove all burrs and debris from joints and fittings.
 - * All joints must be properly cleaned, primed, and cemented. Use only cement and primer approved for use with the pipe material as outlined in the above table.
- All piping must be fully supported. Use pipe hangers at a minimum of 3' (0.9m) intervals. Do not use the water heater to support the vent piping.
- A bird screen must be installed on the vent terminations to prevent debris or animals from entering the piping.

Maximum Vent Length

The unit can be adjusted to accommodate longer vent runs; refer to the below table to find the maximum vent length based on the number of elbows.

Allowable Schedule 40 Vent Length (PVC, CPVC, PP)

Pipe diameter	3" (75mm)	2" (50mm)
No. of Elbows	Max. straight Vent Length*	
6	70'	N/A
5	75'	N/A
4	80'	18'
3	85'	26'
2	90'	34'
1	95'	42'
0	100'	50'

- 5 feet (1.5M) for each additional 3-inch 90-degree elbow
- 2.5 feet (0.75M) for each additional 3-inch 45-degree elbow
- 8 feet (2.4M) for each additional 2-inch 90-degree elbow
- 4 feet (1.2M) for each additional 2-inch 45-degree elbow

* The termination elbow must be included in the total number of elbows.

Vent Termination

Vent Screen Installation

- Install vent screen (Only 3" vent screens are included as accessories), see the below figure for appropriate configuration.
- After connecting vent/air inlet terminal, it is required to install screen for the terminal to prevent incoming of debris and animals, which might cause damage to the unit.
(2" vent screen (1/4" mesh) must be purchased for 2" venting installation)

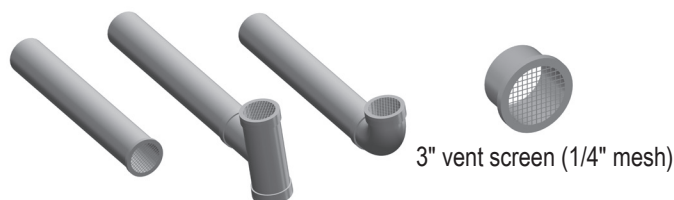

Tightening

- You can select the size of vent pipe(2" or 3") according to the installation conditions.
- Push the pipe into the unit flue until it touches the bottom.
- Tighten the band clamps using a screwdriver.
- Finally, make sure that both pipes(exhaust & air intake) are securely fixed.

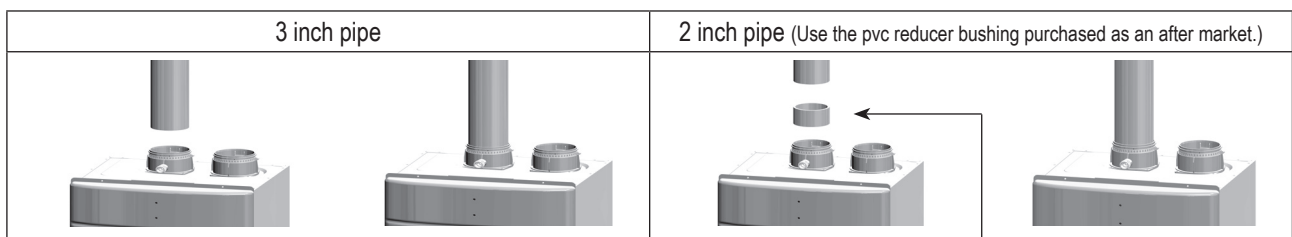

Reducer bushing

Vent Pipe Installation (DV-Direct Vent)

■ **Horizontal Vent Termination- PVC/CPVC Materials Only**

- As illustrated on the right, make sure to keep a distance of 3' (0.9m) or wider between the intake and exhaust when installing the vent piping.
- * If 3' (0.9m) remote distance between Intake and Exhaust cannot be ensured, the installation can be carried out only in the installation method shown in page 18.
- The PVT-HL termination may be used in place of elbows as the horizontal vent terminations. It is not necessary to use bird screens with the PVT-HL termination.
- Terminate at least 12" (300mm) above grade or above snow line.
- Terminate at least 7' (2.1m) above a public walkway, 6' (1.8m) from the combustion air intake of any appliance, and 3' (0.9m) from any other building opening, gas utility meter, service regulator etc.
- Terminate at least 3' (0.9m) above any forced air inlet within 10' (3m) , 1' (0.3m) below, 1' (0.3m) horizontally from or 1' (0.3m) above any door, window, or gravity air inlet into any building per National Fuel Gas Code ANSI Z223.1/NFPA 54.
- Slope the horizontal vent 1/4" upwards for every 12" (300mm) toward the termination.
- Use a condensation drain if necessary.
- In the Commonwealth of Massachusetts a carbon monoxide detector is required for all side wall horizontally vented gas fuel equipment. Please refer to Technical Bulletin TB 010606 for full installation instructions.

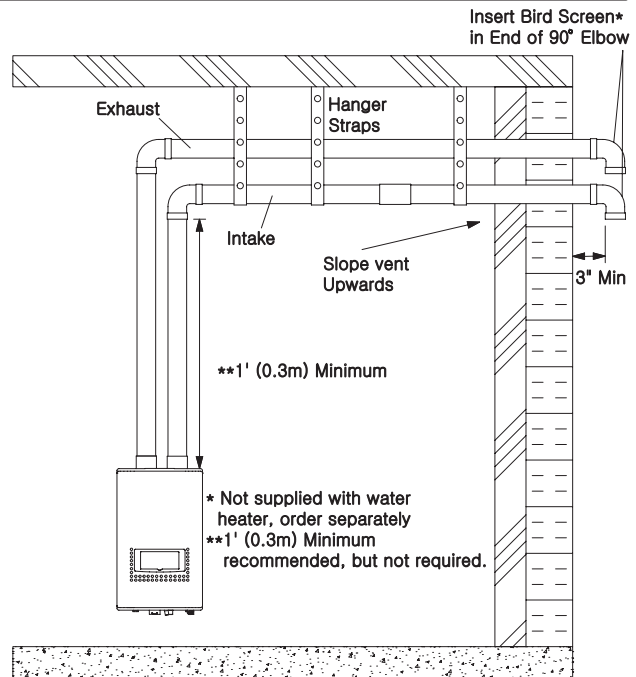

When choosing intake and exhaust terminations, you must use the same type of elbow (i.e. both 90° elbows). This will help with proper combustion by putting both terminations in the same pressure zone.

■ **Vertical Vent Termination- PVC/CPVC Materials Only**

- As illustrated on the right, make sure to keep a distance of 3' (0.9m) or wider between the intake and exhaust when installing the vent piping.
- Terminate at least 6' (1.8m) from the combustion air intake of any appliance, and 3' (0.9m) from any other building opening, gas utility meter, service regulator etc.
- Enclose exterior vent systems below the roof line to limit condensation and protect against mechanical failure.
- When the vent penetrates a floor or ceiling and is not running in a fire rated shaft, a firestop and support is required.
- When the vent termination is located not less than 8' (2.4m) from a vertical wall or similar obstruction, terminate above the roof at least 2' (0.6m), but not more than 6' (1.87m), in accordance with the National Fuel Gas Code ANSI Z223.1/NFPA 54.
- Provide vertical support every 3' (0.9m) or as required by the vent pipe manufacturer's instructions.
- A short horizontal section is recommended to prevent debris from falling into the water heater.
- When using a horizontal section, slope the horizontal vent 1/4" upwards for every 12" (300mm) toward the termination to drain condensate.

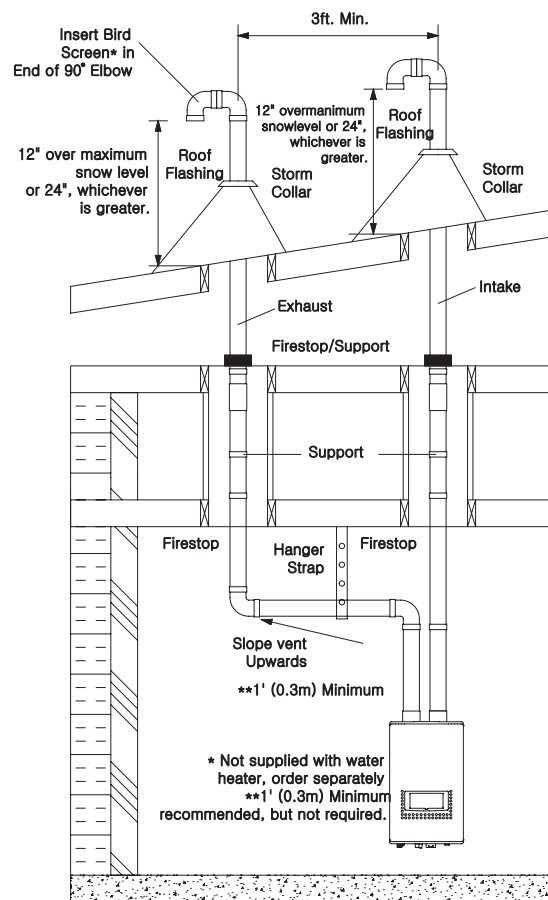

When choosing intake and exhaust terminations, you must use the same type of elbow (i.e. both 90° elbows). This will help with proper combustion by putting both terminations in the same pressure zone.

Vent Pipe Installation (DV-Direct Vent)

■ Concentric PVC/CPVC Termination

- The concentric termination may be shortened, but not lengthened from its original factory supplied length.
- 2" (50mm) & 3" (75mm) PVC or CPVC pipe may be used with the concentric termination. Reducers will be needed to connect 2" pipe. Maintain the same vent pipe diameter from the water heater flue to the termination.
- Do not exceed the maximum vent lengths as specified in this section.
- There must be a 1" (25mm) to 4" (100mm) clearance between the outside wall and the air intake section of the termination as illustrated on the left.
- Install a securing strap to prevent movement of the termination.
- Terminate at least 12" (300mm) above grade or above snow line.
- Terminate at least 7' (2.1m) above a public walkway, 6' (1.8m) from the combustion air intake of any appliance, and 3' (0.9m) from any other building opening, gas utility meter, service regulator etc.
- Terminate at least 3' (0.9m) above any forced air inlet within 10' (3m), 1' (0.3m) below, 1' (0.3m) horizontally from or 1' (0.3m) above any door, window, or gravity air inlet into any building per National Fuel Gas Code ANSI Z223.1/NFPA 54.
- Slope the horizontal vent 1/4" upwards for every 12" (300mm).
- Use a condensation drain if necessary.

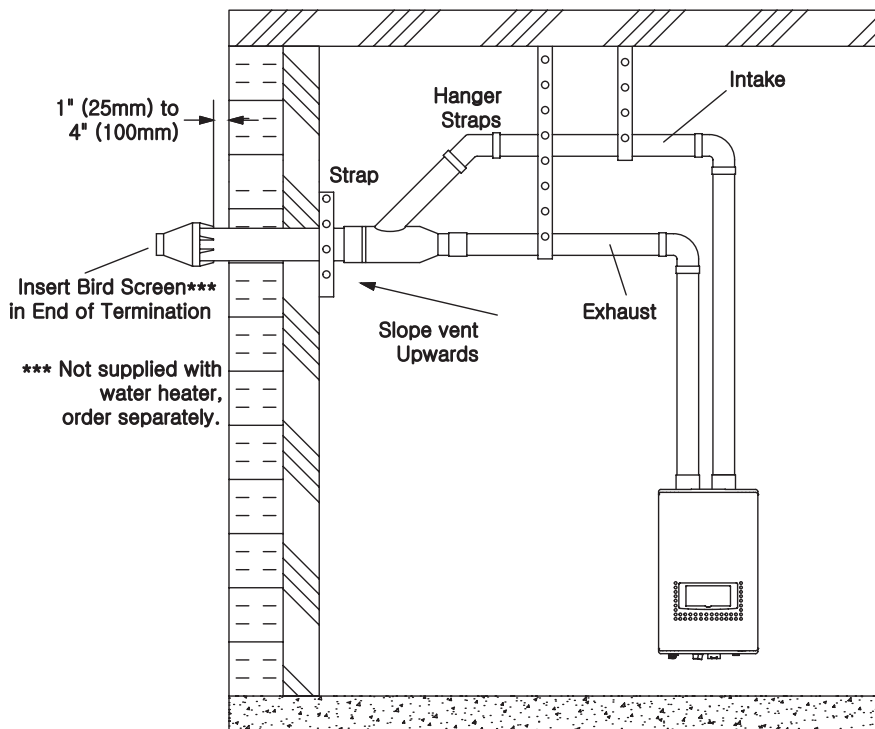

Horizontal

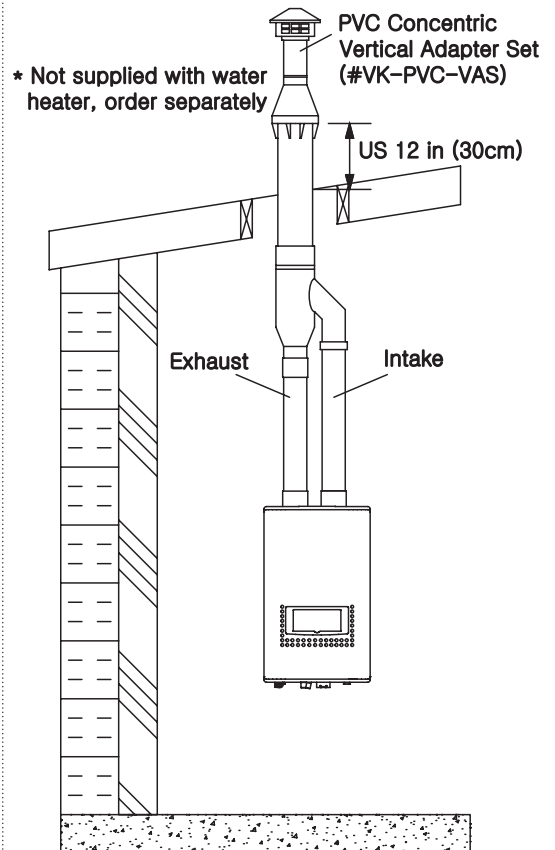

Vertical

Vent Pipe Installation (DV-Direct Vent)

■ **Horizontal Vent Termination- PVC/CPVC Materials Only**

- * When 3' (0.9m) remote distance between Intake and Exhaust cannot be ensured.
- * Can not use Hood termination (PVT-HL)

- Intake and exhaust should face the same direction. Intake and exhaust should stay within the same pressure zone.
- Insert the bird screen. 90° elbow vertical setting (downward).
- Ensure at least 3ft (0.9m) or more distance between the near edge of the air intake pipe or exhaust pipe to the inside corner of a wall.
- Ensure at least 2ft (0.6m) or more distance between intake pipe and exhaust pipe. The distance is measured at inside of pipe to inner dimension.

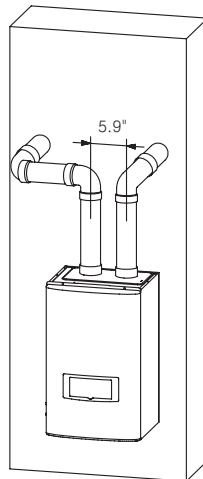

Interior View

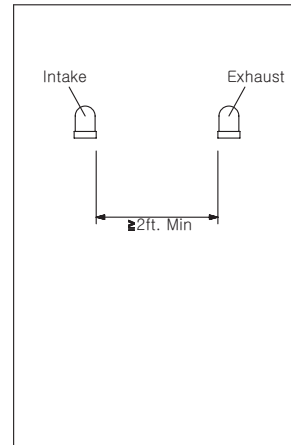

Exterior View

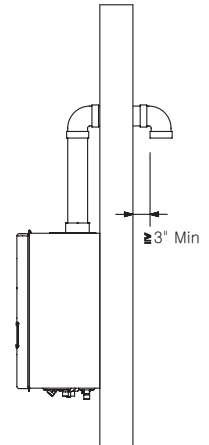

- Intake and exhaust should face the same direction. Intake and exhaust should stay within the same pressure zone.
- Insert the bird screen. 90° elbow vertical setting (downward).
- Ensure at least 3ft (0.9m) or more distance between edge of air intake pipe or exhaust pipe and corner wall.
- Upper side is exhaust, lower side is intake. The reverse orientation is not allowed.
- Ensure at least 1ft (0.3m) or more distance between intake pipe and exhaust pipe. The distance is measured at the outlets of intake port (terminal) and exhaust port (terminal).

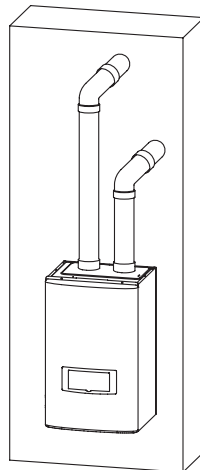

Interior View

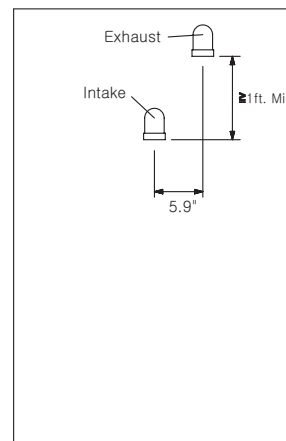

Exterior View

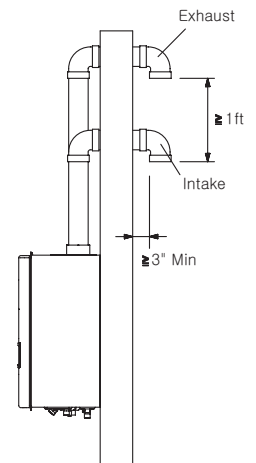

- Intake and exhaust should face the same direction. Intake and exhaust should stay within the same pressure zone.
- Insert the bird screen. 90° elbow vertical setting (downward).
- Ensure at least 3ft (0.9m) or more distance between edge of air intake pipe or exhaust pipe and corner wall.
- The pipe farther from the wall is intake, the side near the wall is exhaust. The reverse connection is not allowed.
- Ensure at least 1ft (0.3m) or more distance between intake pipe and exhaust pipe. The distance is measured at inside of pipe to inner dimension.

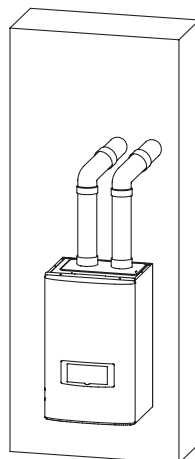

Interior View

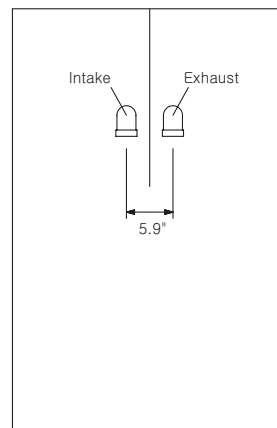

Exterior View

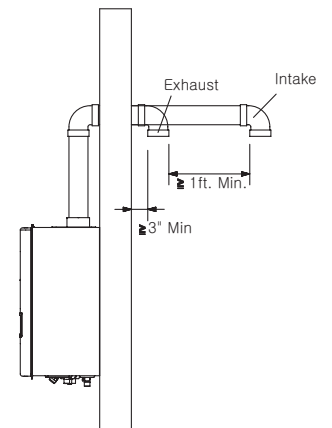

Vent Pipe Installation (SV-Non Direct Vent)

*** When supplying combustion air from the indoors (SV-CK-3 Conversion Kit is required)**

■ Horizontal Vent Termination- PVC/CPVC Materials Only

- A tee, the PVT-HL termination may be used for the vent termination. It is not necessary to use bird screens with the PVT-HL termination.
- Terminate at least 12" (300mm) above grade or above snow line.
- Terminate at least 7' (2.1m) above a public walkway, 6' (1.8m) from the combustion air intake of any appliance, and 3' (0.9m) from any other building opening, gas utility meter, service regulator etc.
- Terminate at least 3' (0.9m) above any forced air inlet within 10' (3m) , 4' (1.2m) below, 4' (1.2m) horizontally from or 1' (0.3m) above any door, window, or gravity air inlet into any building per National Fuel Gas Code ANSI Z223.1/NFPA 54.
- Slope the horizontal vent 1/4" upwards for every 12" (300mm) toward the termination.
- Use a condensation drain if necessary.
- In the Commonwealth of Massachusetts a carbon monoxide detector is required for all side wall horizontally vented gas fuel equipment.

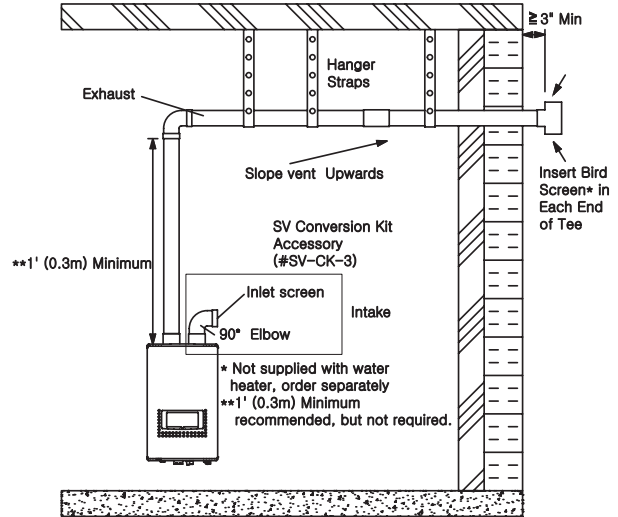

■ Vertical Vent Termination- PVC/CPVC Materials Only

- Terminate at least 6' (1.8m) from the combustion air intake of any appliance, and 3' (0.9m) from any other building opening, gas utility meter, service regulator etc.
- Enclose exterior vent systems below the roof line to limit condensation and protect against mechanical failure.
- When the vent penetrates a floor or ceiling and is not running in a fire rated shaft, a firestop and support is required.
- When the vent termination is located not less than 8' (2.4m) from a vertical wall or similar obstruction, terminate above the roof at least 2' (0.6m), but not more than 6' (1.87m), in accordance with the National Fuel Gas Code ANSI Z223.1/NFPA 54.
- Provide vertical support every 3' (0.9m) or as required by the vent pipe manufacturer's instructions.
- A short horizontal section is recommended to prevent debris from falling into the water heater.
- When using a horizontal section, slope the horizontal vent 1/4" upwards for every 12" (300mm) toward the termination to drain condensate.

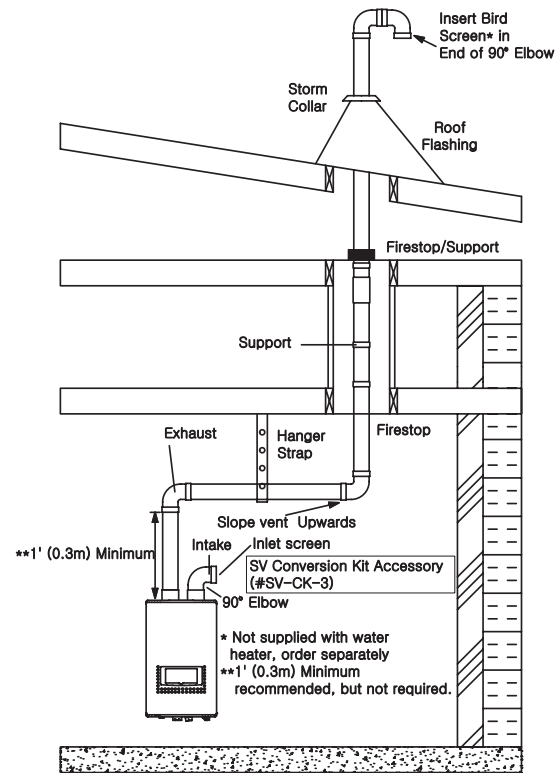

■ Provide adequate combustion air so as to not create negative pressure within the building.

- Provide two permanent openings to allow circulation of combustion air.
- Make each opening 199 square inches if they provide indoor air, and 100 square inches for outdoor air.
- If the unit is installed in a mechanical closet, provide a 24" (600mm) clearance in front of the unit to the door.
- If combustion air will be provided through a duct, size the duct to provide 60 cubic feet of fresh air per minute.

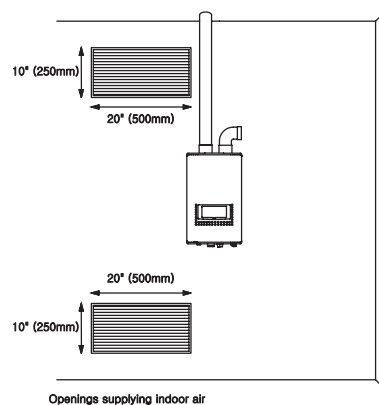

4-3. Gas Piping

In order to choose the proper size for the gas line, consult local codes or the National Fuel Gas Code ANSI Z223.1.

⚠ CAUTION

The guidelines and examples we have provided in this manual section are for reference only. The sizing and installation of the gas system for this water heater, as with any gas appliance, is the sole responsibility of the installer. The installer must be professionally trained to do such work and must always follow all local and national codes and regulations. Gas line sizing calculations must be performed for every installation. Please contact Noritz America at 866-766-7489 if you have any questions or concerns.

Gas Type

The gas type indicated on the water heater rating plate (NG or LP) must match the type of gas being supplied to the water heater.

Gas Conversions

If the gas type supplied does not match the gas type on the rating plate, contact your water heater supplier for a replacement unit with the proper gas type. If a gas type conversion must be made, there are conversion kits available for some models. [The conversion kit shall be installed by a qualified service agency in accordance with the manufacturer's instructions and all applicable codes and requirements of the authority having jurisdiction. The qualified service agency is responsible for the proper installation of this kit. Improper installation of this kit will void the warranty. Conversion kits will only be shipped directly to the Distributor or Agency performing the conversion.]

Meter

The gas meter must be sized properly for the water heater and other gas appliances to operate properly. Select a gas meter capable of supplying the entire btu/h demand of all gas appliances in the building.

⚠ CAUTION

Regulators

Ensure that all gas regulators used are operating properly and providing gas pressures within the specified range of the water heater being installed. Excess gas inlet pressure may cause serious accidents.

⚠ CAUTION

Pressure

Check the gas supply pressure immediately upstream at a location provided by the gas company. Supplied gas pressure must be within the limits shown in the specifications section with all gas appliances operating. The inlet gas pressure must be within the range specified. This is for the purposes of input adjustment. Low gas pressure may cause a loss of flame or ignition failure at other appliances in the home, which may result in unburned gas in the home. Serious accidents such as fire or explosion may result.

Measuring Gas Pressure

In order to check the gas supply pressure to the unit, a tap is provided on the gas inlet. Remove the round head philips screw from the tap, and connect a manometer using a silicon tube.

In order to check the gas manifold pressure, a tap is provided on the gas valve inside the unit. The pressure can be checked either by removing the screw and connecting the appropriate pressure gauge.

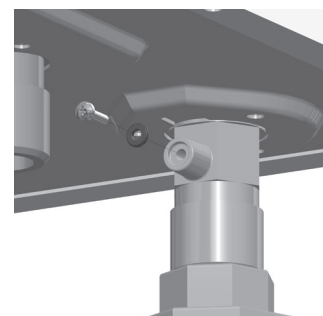

⚠ CAUTION**Pressure Test**

The appliance and its gas connections must be leak tested before placing the appliance in operation. The appliance must be isolated from the gas supply piping system by closing its individual manual shutoff valve during any pressure testing of the gas supply piping system at test pressures equal to or less than ½ psig (3.5 kPa). We do not recommend pressure testing in excess of ½ psig (3.5kPa). If it must be done, the appliance and its individual shutoff valve must be completely disconnected from the gas supply piping system during the test process.

Pipe Sizing/Flexible Connectors

A gas shutoff valve must be installed on the supply line. Gas flex lines are not recommended unless the minimum inside diameter is ¾" or greater and the rated capacity of the connector is equal to or greater than the BTU capacity of the water heater. Gas piping shall be in accordance with local utility company requirements and/or in the absence of local codes, use the latest edition of National Fuel Gas Code (NFPA54GC), ANSI Z223.1. In Canada, use the latest edition of CSA B149.1, National Gas and Propane installation code. Size the gas line according to total btu/h demand of the building and length from the meter or regulator so that the following supply pressures are available even at maximum demand.

Natural Gas Supply Pressure
Min 3.5" WC
Max 10.5" WC

LP Gas Supply Pressure
Min 8" WC
Max 14" WC

Reference Tools & Sample Calculations**⚠ CAUTION**

The tables and samples below are for reference only. The professional sizing and installing the gas line should always run the appropriate calculations before all installations..

Which Table to Use

- For NG installations with the initial supply pressure at point of delivery (at the meter, for example) is less than 8" WC, use the 0.5" WC pressure drop table (Table 1 on page 22).
- For NG installations with the initial supply pressure at point of delivery is greater than or equal to 8" WC, use the 3.0" pressure drop table (Table 2 on page 22).
- For all LP installation use (Table 3 on page 22)

The inlet pressure must be at least 5" WC for NG or 8" WC for LP for all appliances in the gas system. If the inlet gas pressure drops below 5" WC for NG or 8" WC for LP, the heater may continue to operate, but the other appliances in the house may experience flame loss or ignition failure, which can result in gas leakage into the home. Refer to the NFPA 54 for details.

Please contact Noritz for details. For corrugated stainless steel tubing (CSST) capacity tables, please consult with the manufacturer.

Gas Line Sizing for a Noritz Condensing Tankless Gas Water Heater

Table 1. For Less than 8" WC initial supply pressure
Maximum Natural Gas Delivery Capacity (0.5" WC Pressure Drop)

Pipe size	Length (ft)										
	10'(3m)	20'(6m)	30'(9m)	40'(12m)	50'(15m)	60'(18m)	70'(21m)	80'(24m)	90'(27m)	100'(30m)	125'(37.5m)
3/4"	360	247	199	170	151	137	126	117	110	104	92
1"	678	466	374	320	284	257	237	220	207	195	173
1-1/4"	1390	957	768	657	583	528	486	452	424	400	355
1-1/2"	2090	1430	1150	985	873	791	728	677	635	600	532
2"	4020	2760	2220	1900	1680	1520	1400	1300	1220	1160	1020
2 1/2"	6400	4400	3530	3020	2680	2430	2230	2080	1950	1840	1630
3"	11300	7780	6250	5350	4740	4290	3950	3670	3450	3260	2890
4"	23100	15900	12700	10900	9660	8760	8050	7490	7030	6640	5890

Contact the Gas Supplier for Btu/Cubic Ft. of the Supplied Gas. 1000 BTU/Cubic Ft. is a Typical Value

Table 2. For 8" WC ~ 10.5" WC initial supply pressure
Maximum Natural Gas Delivery Capacity (3.0" WC Pressure Drop).

Pipe size	Length (ft)										
	10'(3m)	20'(6m)	30'(9m)	40'(12m)	50'(15m)	60'(18m)	70'(21m)	80'(24m)	90'(27m)	100'(30m)	125'(37.5m)
1/2"	454	312	250	214	190	172	158	147	138	131	116
3/4"	949	652	524	448	397	360	331	308	289	273	242
1"	1787	1228	986	844	748	678	624	580	544	514	456
1-1/4"	3669	2522	2025	1733	1536	1392	1280	1191	1118	1056	936
1-1/2"	5497	3778	3034	2597	2302	2085	1919	1785	1675	1582	1402
2"	10588	7277	5844	5001	4433	4016	3695	3437	3225	3046	2700
2 1/2"	16875	11598	9314	7971	7065	6401	5889	5479	5140	4856	4303
3"	29832	20503	16465	14092	12489	11316	10411	9685	9087	8584	7608
4"	43678	30020	24107	20632	18286	16569	15243	14181	13305	12568	11139

Table 3. Maximum Undiluted Propane (LP) Delivery Capacity in Thousands of Btu/H (0.5" WC Pressure Drop)

Pipe size	Length (ft)												
	10'(3m)	20'(6m)	30'(9m)	40'(12m)	50'(15m)	60'(18m)	80'(24m)	100'(30m)	125'(38m)	150'(45m)	175'(53m)	200'(60m)	250'(76m)
1/2"	275	189	152	129	114	103	96	89	83	78	69	63	55
3/4"	567	393	315	267	237	217	196	185	173	162	146	132	112
1"	1071	732	590	504	448	409	378	346	332	307	275	252	213
1-1/4"	2205	1496	1212	1039	913	834	771	724	677	639	567	511	440
1-1/2"	3307	2299	1858	1559	1417	1275	1181	1086	1023	976	866	787	675
2"	6221	4331	3465	2992	2646	2394	2205	2047	1921	1811	1606	1496	1260

** For reference only. Please consult gas pipe manufacturer for actual pipe capacities.

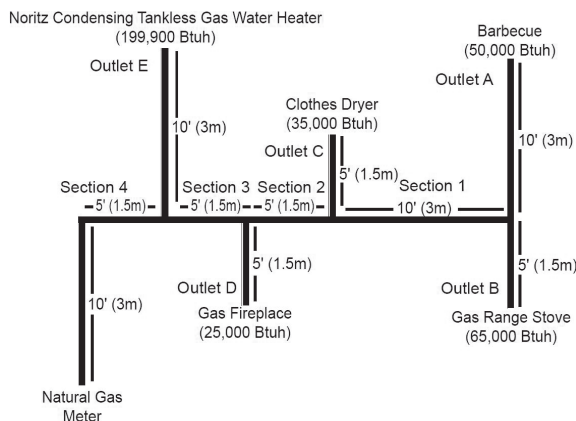

Instructions

1. Size each outlet branch starting from the furthest using the Btu/h required and the length from the meter.
2. Size each section of the main line using the length to the furthest outlet and the Btu/h required by everything after that section.

Sample Calculation

- Outlet A: 45' (13.5m) (Use 50' (15m)), 50,000 Btu/h requires 1/2"
- Outlet B: 40' (12m), 65,000 Btu/h requires 1/2"
- Section 1: 45' (13.5m) (Use 50' (15m)), 115,000 Btu/h requires 3/4"
- Outlet C: 30' (9m), 35,000 Btu/h requires 1/2"
- Section 2: 45' (13.5m) (Use 50' (15m)), 150,000 Btu/h requires 3/4"
- Outlet D: 25' (7.5m) (Use 30' (9m)), 25,000 Btu/h requires 1/2"
- Section 3: 45' (13.5m) (Use 50' (15m)), 175,000 Btu/h requires 1"
- Outlet E: 25' (7.5m) (Use 30' (9m)), 199,900 Btu/h requires 3/4"
- Section 4: 45' (13.5m) (Use 50' (15m)), 374,900 Btu/h requires 1-1/4"

** For reference only. Please consult gas pipe manufacturer for actual pipe capacities.

4-4. Water Piping

Installation must be performed by a qualified plumber. In the Commonwealth of Massachusetts, this product must be installed by a licensed plumber or gas fitter in accordance with the Massachusetts Plumbing and Fuel Gas Code 248 CMR Sections 2.00 and 5.00. Observe all applicable codes.

This appliance is suitable for combination potable water and space heating applications. It cannot be used for space heating applications only. Do not use this appliance if any part has been underwater. Immediately call a qualified service technician to inspect the appliance and replace any part of the control system and gas control which has been under water.

If the water heater is installed with a return line that includes backflow preventer, such as one having a backflow preventer in the cold water supply line, means shall be provided to control thermal expansion. Contact the water supplier or a local plumbing inspector on how to control this situation.

A pressure relief valve must be installed near the hot water outlet that is rated in accordance with and complying with either The Standard for Relief Valves and Automatic Shutoff Devices for Hot Water Supply Systems, ANSI Z21.22, or ANSI/ASME Boiler and Pressure Vessel Code, Section IV (Heating Boilers). This pressure relief valve must be capable of an hourly Btu rated temperature steam discharge of 199,000 Btu/h. Multiple valves may be used. The pressure relief capacity must not exceed 150 psig. No valve shall be placed between the relief valve and the water heater. The relief valve must be installed such that the discharge will be conducted to a suitable place for disposal when relief occurs. No reducing coupling or other restriction may be installed in the discharge line. The discharge line must be installed to allow complete drainage of both the valve and the line. If this unit is installed with a separate storage vessel, the separate vessel must have its own temperature and pressure relief valve. This valve must also comply with The Standard for Relief Valves and Automatic Gas Shutoff Devices for Hot Water Supply Systems, ANSI Z21.22. (in the U.S. only). A temperature relief valve is not required, but if one is used, do not install the valve with the probe directly in the flow of water. This may cause unwarranted discharge of the valve.

Piping and components connected to the water heater shall be suitable for use with potable water. Toxic chemicals, such as those used for boiler treatment, shall not be introduced into the potable water. A water heater used to supply potable water may not be connected to any heating system or components previously used with a nonpotable water heating appliance.

When water is required in one part of the system at a higher temperature than in the rest of the system, means such as a mixing valve shall be installed to temper the water to reduce the scald hazard.

- Flush water through the pipe to clean out metal powder, sand and dirt before connecting it.

- Perform the following insulation measures for prevention of freezing.

1. Take appropriate heat insulation measures (e.g., wrapping with heat insulation materials, using electric heaters) according to the climate of the region to prevent the pipe from freezing.
2. Make sure that there are no water leaks from the cold and hot water supply pipes, then insulate the pipes completely.
3. Be sure to also completely insulate the water supply valve and the cold and hot water connections on the water heater (refer to the figure on the right).
4. Do not cover the water drain plug with insulation so that water in the pipe can be drained. (Refer to the figure in the right.)

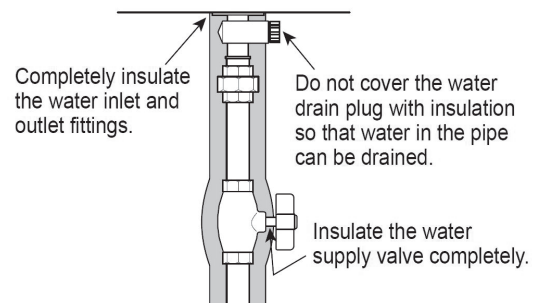

- Use a union coupling or flexible pipe for connecting the pipes to reduce the force applied to the piping.

- Do not use piping with a diameter smaller than the coupling.

- When feed water pressure is too high, insert a pressure regulating valve, or take water hammer prevention measure.

- Avoid using joints as much as possible to keep the piping simple.

- Avoid piping in which an air holdup can occur.

- If installing the unit on a roof:

About lower-level hot water supply.

If the unit is installed on a roof to supply water to the levels below, make sure that the water pressure supplied to the unit does not drop below 29 psi. It may be necessary to install a pump system to ensure that the water pressure is maintained at this level.

Check the pressure before putting the unit into operation.

Failure to supply the proper pressure to the unit may result in noisy operation, shorter lifetime of the unit, and may cause the unit to shut down frequently.

Supply water piping

- Do not use PVC, iron, or any piping which has been treated with chromates, boiler seal or other chemicals.
- Mount a check valve and a shut off valve (near the inlet).
- In order for the client to use the water heater comfortably, 98.1 to 491 kPa (14 to 70 PSI) of pressure is needed from the water supply. Be sure to check the water pressure. If the water pressure is low, the water heater cannot perform to its full capability, and may become a source of trouble for the client.

Drain piping

- Expansion water may drop from the pressure relief valve and wet the floor. If necessary, provide drain piping or use a drain hose to remove the water.

Hot water piping

- Do not use lead, PVC, iron or any piping which has been treated with chromates, boiler seal or other chemicals.
- The longer the piping, the greater the heat loss. Try to make the piping as short as possible.
- Use mixing valves with low water resistance. Use shower heads with low pressure loss.
- If necessary, use a pump or other means to ensure that the supply water pressure to the inlet of the heater does not fall below 29 PSI when the maximum amount of water is being demanded. Also install a pressure meter on the inlet. If this is not done, local boiling will occur inside the water heater causing abnormal sounds and decreasing the durability of the heat exchanger.

Freeze Prevention

1-1. Recirculation Pump mode.

- When water temperature falls between 42°F(5.5°C) and 46°F(8°C), the circulation pump starts operating for freeze protection.
- Mixing valve maintains open for internal water circulation.
- The cycle will restart at the approximate time interval (operate for 10 min and stops for 30 sec) and it will stop if the water temperature goes above 50°F(10°C).

1-2. Burner Combustion mode.

- When water temperature drops below 41°F (5°C) it will start minimum combustion with internal water circulation.
- When water temperature goes above 104°F (40°C) it will stop.
- After combustion mode is stopped, the pump will continue for 3 minutes..
- If the water heater is turned on for recirculation mode, pre-heating mode, or hot water use mode, the freeze protection mode will automatically stop.

Electrical power, gas, water, and the main switch must be on. If any of the above items are not connected properly, then water must be drained including the condensation trap and unit unplugged from electrical power.

Water Treatment

If this water heater will be installed in an application where the supply water is hard, the water must be treated with either the Noritz H2Flow or Scale Shield or a water softener. Refer to the below tables for suggested treatment and maintenance measures to be taken based on the water hardness level. Damage to the water heater as a result of water in excess of 12 gpg (200 mg/L) of hardness is not covered by the Noritz America Limited Warranty.

Note: Water softeners may be regulated by the local water jurisdiction, consult with the manufacturer for code, sizing, and installation guidelines; the below diagram is for reference only. For more information about H2Flow and Scale Shield, contact Noritz America at 866-766-7489.

Residential Use Treatment Guidelines

Type of Water	Hardness Level	Treatment Device	Flush Frequency*
Soft	0-1 gpg (0-17 mg/L)	None	None
Slightly Hard	1-3 gpg (17-51 mg/L)	None	None
Moderately Hard	3-7 gpg (51-120 mg/L)	H2Flow or ScaleShield	Once a Year**
Hard	7-10 gpg (120-171 mg/L)	H2Flow or ScaleShield	Once a Year**
Very Hard	10-14 gpg (171-239 mg/L)	H2Flow	Treatment Required
Extremely Hard	> 14 gpg (> 239 mg/L)	H2Flow	Treatment Required

* Install Noritz Isolation Valves to allow for flushing.
 ** Flushing is required if a water treatment device is not installed.

Water Treatment System

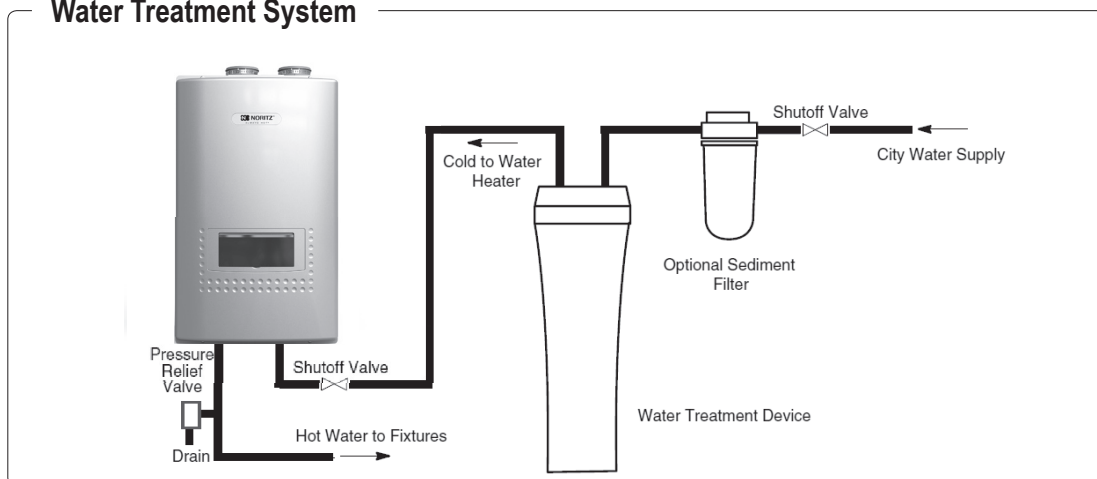

4-5. Condensate Piping

⚠ CAUTION

Due to the acidic nature of the condensate, be sure to properly drain and if necessary, treat the condensate prior to disposal. Damage caused by improperly handled condensate is not covered by the warranty.

- This water heater is a high efficiency, fully condensing appliance which produces acidic condensate during operation. The water heater incorporates a collection and removal system which must be properly drained in order to ensure proper operation of this appliance.
- The pH level of the condensate is approximately 2-3. An external neutralizer must be installed on the drain piping prior to disposal when required by local code or when the condensate could cause damage.
- If an external neutralizer is installed, periodic replacement of the neutralizing agent will be required. Refer to the instructions supplied with the neutralizer for suggested replacement intervals.
- In order to drain the condensate, a 1/2" threaded fitting is provided at the base of the water heater. Do not reduce the size of this fitting or the drain piping to less than 1/2". In cold climates, do not drain the condensate to the outdoors. If the drain pipe freezes during cold weather, the pipe will not drain condensate and the unit will stop operating.
- Use plastic pipe, such as PVC, for the drain line. Do not use steel, black iron, or any other material which can corrode when placed into contact with acidic condensate.
- Keep the length of the drain pipe as short as possible. Long runs or applications where the nearest drain is above the water heater will require the use of a condensate pump. Size the pump to allow for a maximum condensate discharge of 2 GPH from the water heater.
- Horizontal runs must be sloped 1/4" per foot towards the drain or condensate pump. The condensate will be discharged by gravity force only. Make the drain pipe run as short as possible.
- The end of the drain pipe must not be submerged in water or blocked in any way. To ensure proper drainage, leave the end of the drain pipe open to the atmosphere. Do not have a trap. Also, make sure that there are no obstructions blocking the drain line from discharging condensate.
- Be sure to check that condensate is freely flowing from the drain piping after the system has been installed. Condensate will begin flowing out of the water heater within 15 minutes after operation has started.
- Take measures to prevent the condensate drain lines from freezing (insulation, heat tape, electric heaters, etc.).
- The bottom of the water heater must be higher than the top of the laundry tub to use this option. The condensate drain pipe must have a negative slope to drain properly.

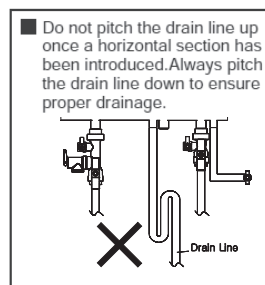
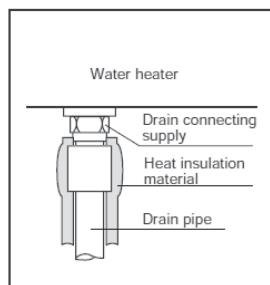

Condensate piping to floor drain

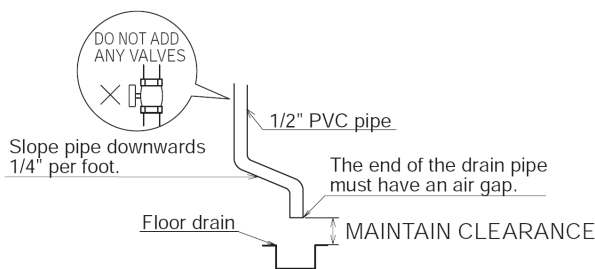

Condensate piping with pump

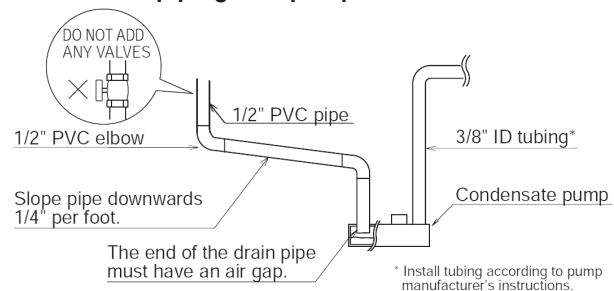

Note:

If the drain line becomes clogged or frozen, condensate will back-up into the water heater and a "29" error code will flash on the display window, ceasing operation. If this occurs, clear the clog or freeze so that condensate can freely flow. Be sure to slope the drain pipe, use the appropriate size pipe, allow the proper clearances, and apply freeze prevention measures (when necessary) to prevent the drain line from clogging or freezing..

4-6. Plumbing Applications

Select Water Heater Mode

Mode	Description	Return Line	Inst. Mode Setting		Hot Water Speed	Energy	Default (Recirculation Time)
			Recirculation Setting	Recirculation Mode			
Standard (Default) - page 26	Same as other Tankless water heater	N/A	OFF	N/A	Good	Best	-
Internal Recirculation - page 28	Similar to tank water heater without recirculation system	N/A	ON	Internal	Better	Better	5:00 ~ 8:00 AM 5:00 ~ 11:00 PM
External Recirculation - page 27	Quicker hot water	Required	ON	External	Best	Good	

Recirculation timer setting can be changed by customer's own desire time.
 Auto (self learning mode) function can be selected by customer's need.
 Please refer to page 22 from owner's guide for more detailed information for timer setting and auto function.

You can choose from two pre-heating modes:

Internal Recirculation Mode or External Recirculation Mode. To select a recirculation mode, you must set from the 'Installer Mode' on the front control panel.(Refer to the page 33)

When you use a recirculation mode, there will be some minor efficiency loss, as a result of the water heater maintaining a steady temperature within the recirculation loop.

With the recirculation operation, hot water will be automatically circulated in the hot water pipes. Even with this function activated, it may take several minutes for hot water to be completely circulated through the plumbing system. Set the timer to activate the recirculation system prior to the first use of hot water to ensure hot water is available.

1. Standard Mode

1. Only POTABLE water may be plumbed through the water heater.
2. The water heater cannot be used for space heating applications.
3. Expansion tank is required if a backflow preventer is installed.
4. Noritz recommends the use of an Isolation valve kit with the installation.
5. This kit includes an integrated shut-off and service valve with unions and a pressure relief valve.

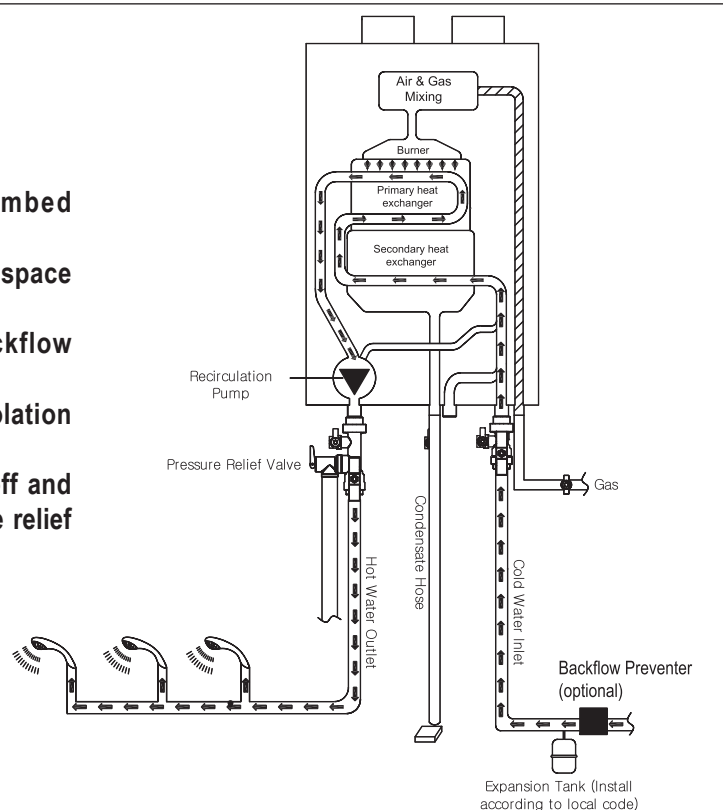

2. External Recirculation mode

The recirculation pipe must be installed in the field in order to apply the 'External Recirculation Mode'. This mode allows the water heater recirculation pipes to be warmed up and serving as the freeze protection function.

When using external recirculation mode with the built-in pump, check the following maximum recirculation pipe lengths including fittings (3/4" pipe is recommended):
 -1/2" Pipe- 200' (60m) of equivalent length
 -3/4" Pipe- 500' (150m) of equivalent length
 Lengths in excess of these limits will require an external recirculation pump.

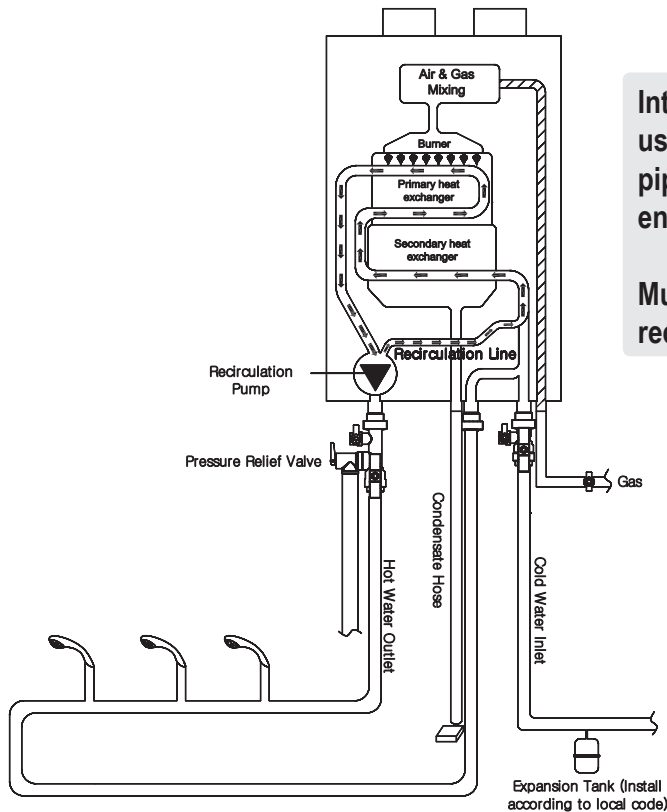
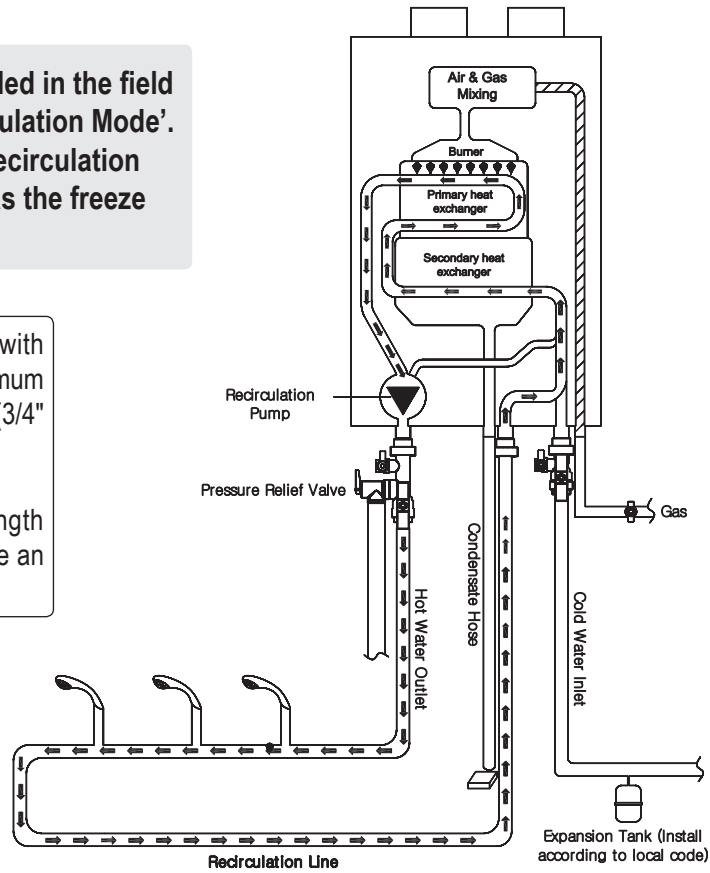

Internal recirculation mode can be used even with external recirculation pipe installed if user wants to save energy cost.
 Must set water heater to internal recirculation mode.

3. Internal Recirculation mode

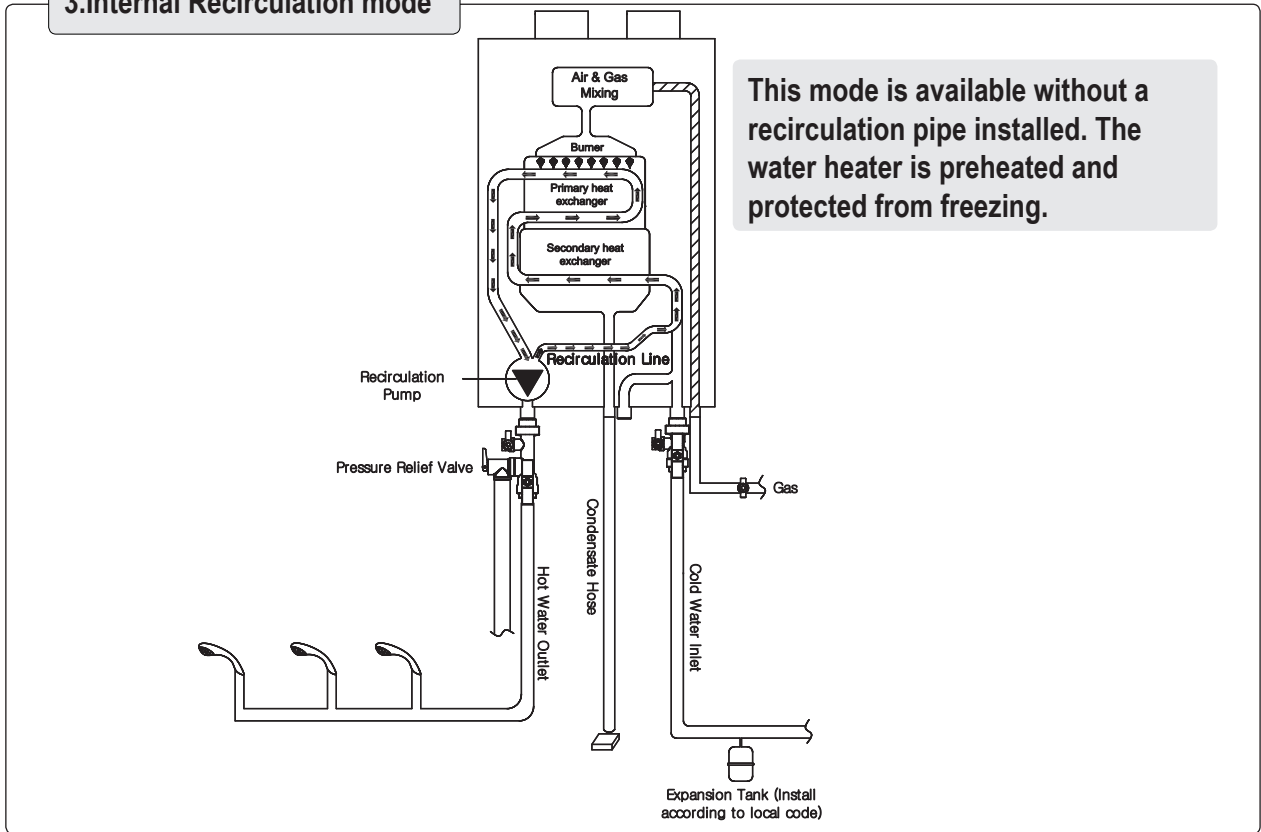

Pressure Relief Valve

- External pressure relief valve must be installed. Observe the following. Failure to comply with the guidelines on installing the pressure relief valve and discharge piping can result in personal injury, death or substantial property damage.
- DO NOT install a relief valve with pressure higher than 150psi. This is the maximum allowable relief valve setting for the water heater.
- Approved 'Pressure Relief Valve' should be applied. An approved ASME HV Valve must be installed on the hot water supply line for hydronic domestic hot water loop as close to the unit as possible. (Valve size 3/4" , maximum 150psi) Refer to the figure below for more information on approved pressure relief valves.
- Direct the discharge piping of the pressure relief valve so that hot water will not splash on anyone or any nearby equipment. Attach the discharge line to the pressure relief valve and run the end of the line to within 6-12" (150-300mm) of the floor.
- No other valve should be placed between the pressure relief valve and the appliance.

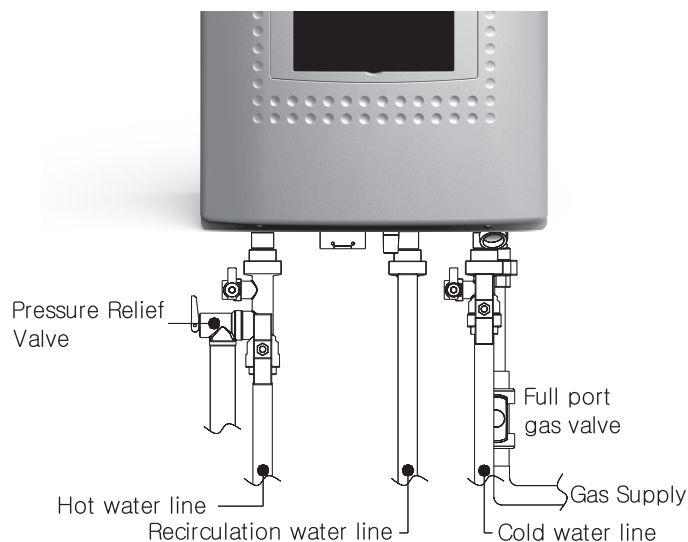

4-7. Electrical Wiring

Do not connect electrical power to the unit until all electrical wiring has been completed.

Do not connect electrical power to the unit until all electrical wiring has been completed.

This appliance must be electrically grounded in accordance with local codes, or in the absence of local codes, with the National Electrical Code, ANSI/NFPA 70. In Canada, the latest CSA C22.1 Electrical Code.

Caution: Label all wires prior to disconnection when servicing controls. Wiring errors can cause improper and dangerous operation.

Verify proper operation after servicing.

Field wiring to be performed at time of appliance installation.

⚠ WARNING**Electrical Shock Hazard**

Do not turn power on until electrical wiring is finished. Disconnect power before servicing. Failure to do so may result in death or serious injury from electrical shock

- The electrical supply required by the water heater is 120VAC at 60 Hz. The power consumption may be up to 172W. Use an appropriate circuit.
- Do not disconnect the power supply when not in use. When the power is off, the freeze prevention in the water heater will not activate, resulting in possible freezing damage.
- The electrical supply must be connected by designated power circuit.
- Do not let the power cord contact the gas piping.
Tie the redundant power cord outside the water heater. Putting the redundant length of cord inside the water heater may cause electrical interference and faulty operation.

Ground

- To prevent electrical shock, provide a ground with resistance less than 100Ω . An electrician should do this work.
Do not connect the ground to the city water or gas piping. Do not tie the ground to a telephone line.

Breaker Installation

- Mount a device which shuts off the electrical path automatically (leakage breaker) when electrical leakage is detected.

⚠ CAUTION

Electrostatic discharge can affect electronic components. Take precautions to prevent electrostatic discharges from personnel or hand tools during the water heater installation and servicing to protect product's electronic control.

⚠ CAUTION

Do not disconnect the electric power, gas and inlet water supply when not in use. If any of these item are not properly connected freezing damage may occur. In this case, please drain all of water in the unit including condensate trap and unplug the unit.

4-8. Setting the Control Panel. (Recirculation mode)

- ▶ To use the 'Recirculation Timer Mode', the device's internal clock should be adjusted to the current time. Clock settings can be set in the 'User mode'.

[To enter 'User Mode']

Power on the control panel must be on.

Press and hold 'Function Button' for approximately 5 Seconds to enter 'User mode'.

'[A:GA]' is displayed on the display screen. From here, turn the 'Dial Button' to start the setting.

Clock Adjustment

- Set in '[L:TA]' mode' after turning the 'Dial Button' in 'User Mode'.
- Set the YEAR - MONTH - DAY - DAY OF THE WEEK - HOUR - MINUTE in regular sequence..

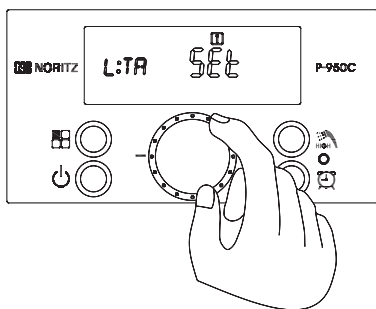

Turn the dial button clockwise until '[L:TA]' is displayed.

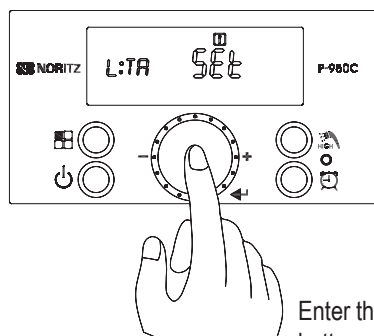

Enter the clock 'Setting mode' by pressing dial button when flashing the [L:TA] character.

Customer can set the current date, time and day in '[L:TA]' mode'.

1. Setting year : 2014

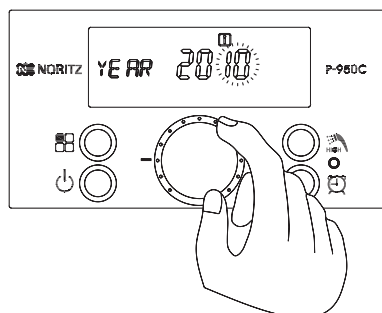

Set the 'Year' by turning the dial button. (Only the flashing number can be changed.)

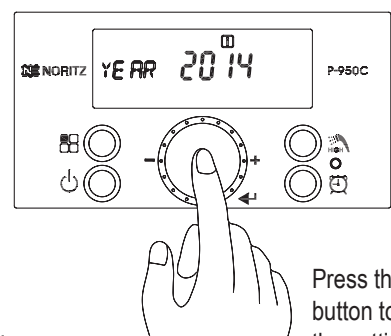

Press the dial button to store the setting.

2. Setting month : 7

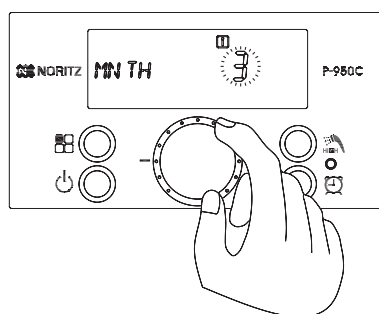

Set the 'month' by turning the dial button. (Only the flashing number can be changed..)

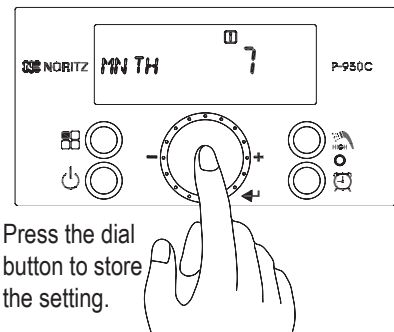

Press the dial button to store the setting.

3. Setting day : 25

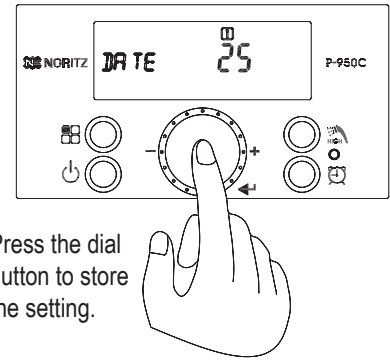
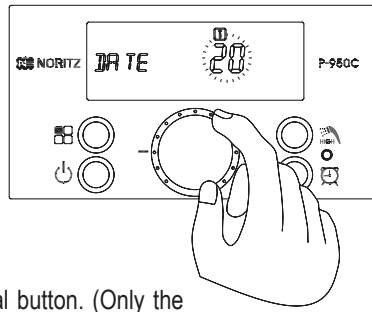

Set the 'day' by turning the dial button. (Only the flashing number can be changed.)

Press the dial button to store the setting.

4. Setting day of the week: Friday

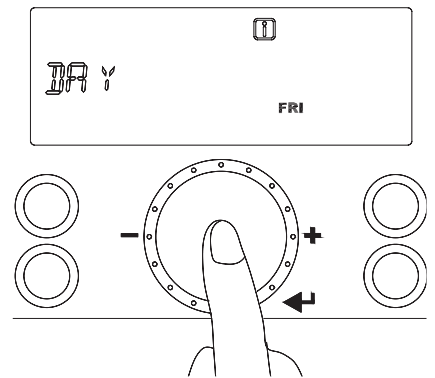
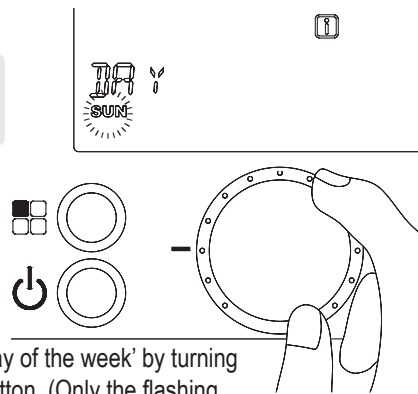

Set the 'day of the week' by turning the dial button. (Only the flashing number can be changed.)

Press the dial button to store the setting.

5. Setting hour : 10

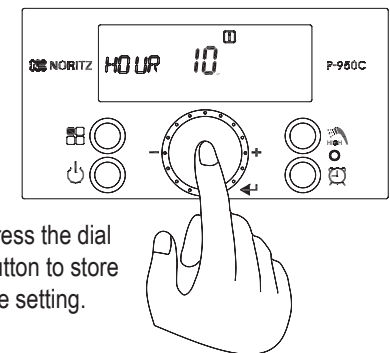
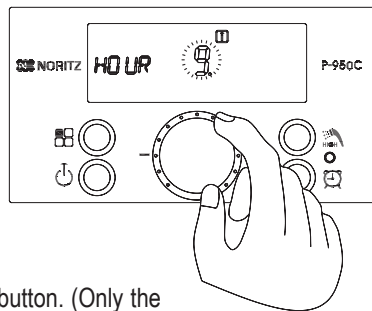

Set the 'hour' by turning the dial button. (Only the flashing number can be changed.)

Press the dial button to store the setting.

6. Setting minute : 20

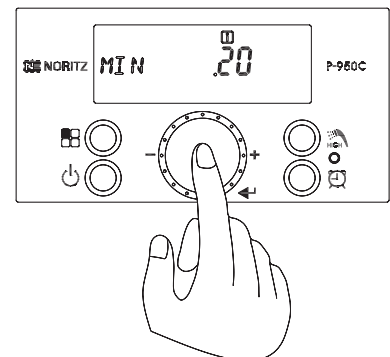
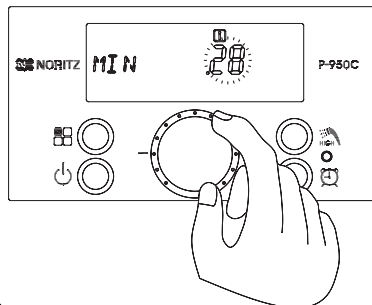

Set the 'minute' by turning the dial button. (Only the flashing number can be changed..)

Press the dial button to store the setting.



[For example]
2014 / July / 25 / Friday 10
hour / 20 min

Press 'Function Button ()' to return to normal operation mode.

Setting the Control Panel. (Recirculation system)

To set the recirculation type (External or Internal mode)

1. Turn off the power to the control panel. Press and hold the 'Function Button' for approximately 5 seconds to get into the 'Installer mode'.

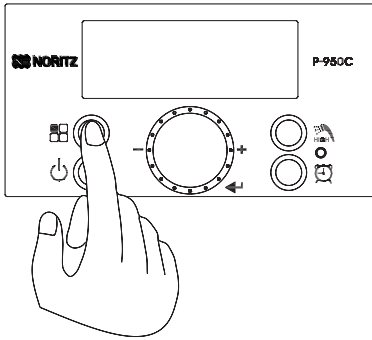

2. Turn the dial button in 'Installer mode' to '[1:RC]'.
3. 'oFF' character is flashed when the dial button is pressed. (Default setting is 'oFF' and recirculation function is turned off.)

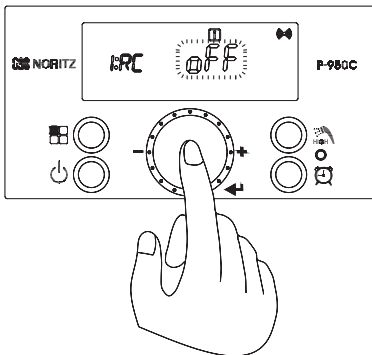

4. Turn the dial button clockwise to select 'on' in order to activate the recirculation function.
5. Press the dial button to store the current setting and return back to 'Installer mode'.

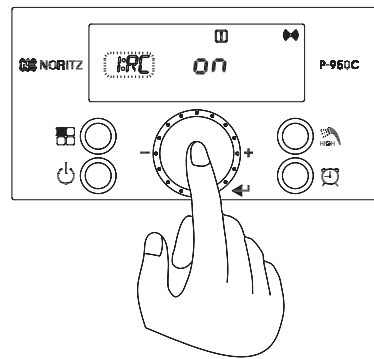

6. Locate '[2:RM]' by turning the dial button clockwise by one click.
7. Press the dial button when the flashing [2:RM].

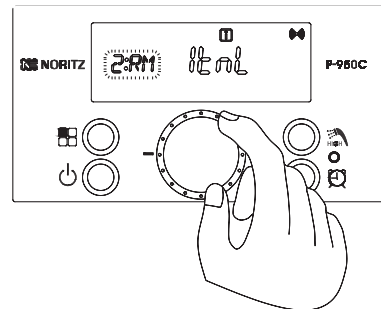

8. Turn the dial button to select [Etnl] 'External Recirculation Mode' or [Itnl] 'Internal Recirculation Mode'.

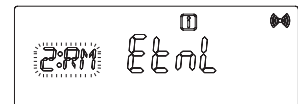
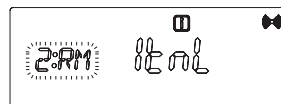
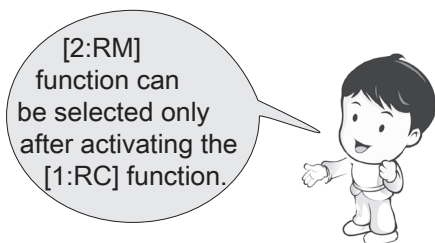

Screen Display	Operation	Description
Itnl	Internal Recirculation Mode	Internal recirculation system is operated during [1:RC] mode turned on.
Etnl	External Recirculation Mode	External recirculation system is operated during [1:RC] mode turned on.

Setting the Control Panel. (High Elevation)

To set the High Elevation

1. Turn off the power to the control panel. Press and hold the 'Function Button' for approximately 5 seconds to get into the 'Installer mode'.
4. Turn the dial button clockwise to select the value that corresponds to the installation elevation.

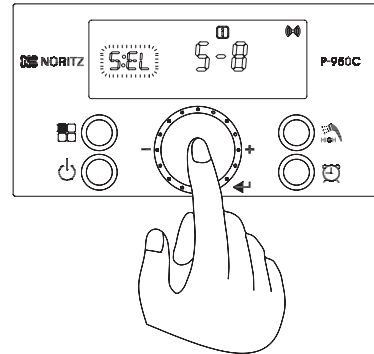
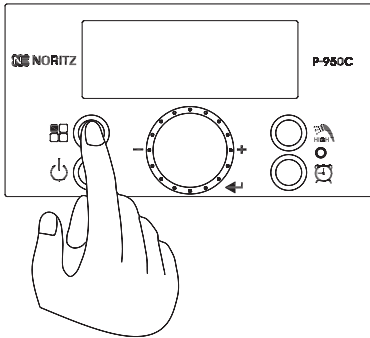

2. In 'Installer Mode,' turn the dial button clockwise until the display reads '[5:EL]'.
 3. '0-2' will flash when the dial button is pressed. (The default setting is '0-2' for installations at 0-2,000 ft elevation)
5. Press the dial button to store the current setting and return back to 'Installer mode'.

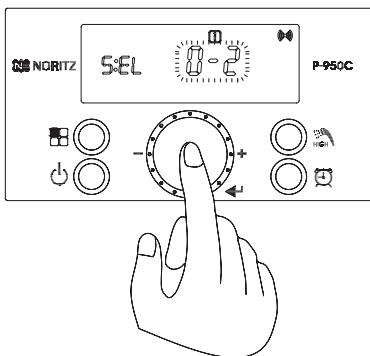

4-9. Quick Connect Multi System Installation

The Quick Connect Multi System allows the installation of two units together utilizing only the Quick Connect Cord.

- Quick Connect Multi System cannot allow more than 2 units.
- All units within Quick Connect Multi System must be of the same model.
- Different models cannot work as Quick Connect Multi System.

The Quick Connect Cord is 6 ft. (1.8m) long. Install the units 2-18" (50 - 457mm) apart from each other to ensure the cable will be able to reach between the units. (See Typical Plumbing diagram). (If the distance between the two units is too great, not only the cable won't be able to reach, but the water temperature may also become unstable because of the difference in pipe length between the two units).

■ System Diagram

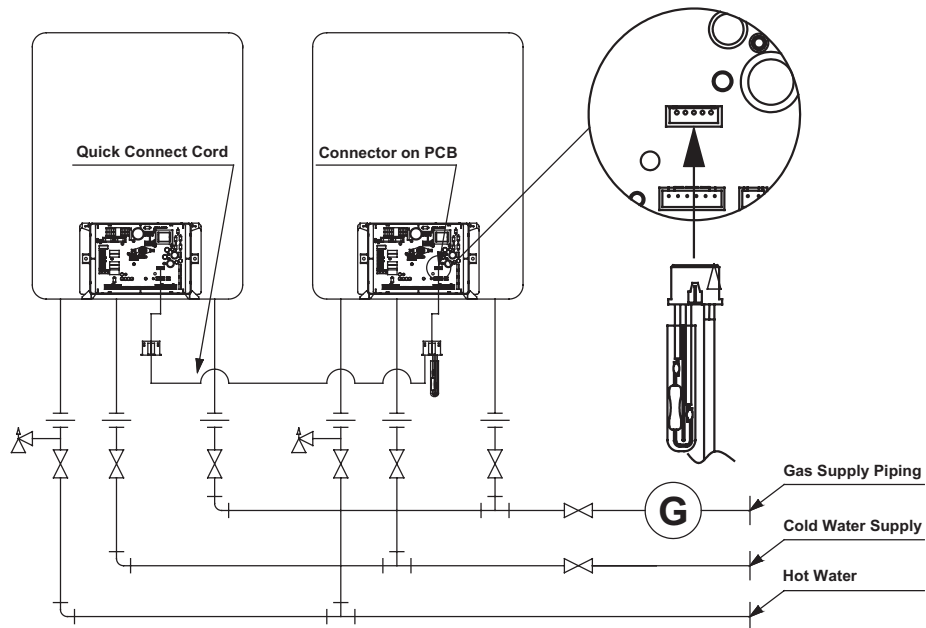

■ Typical Plumbing

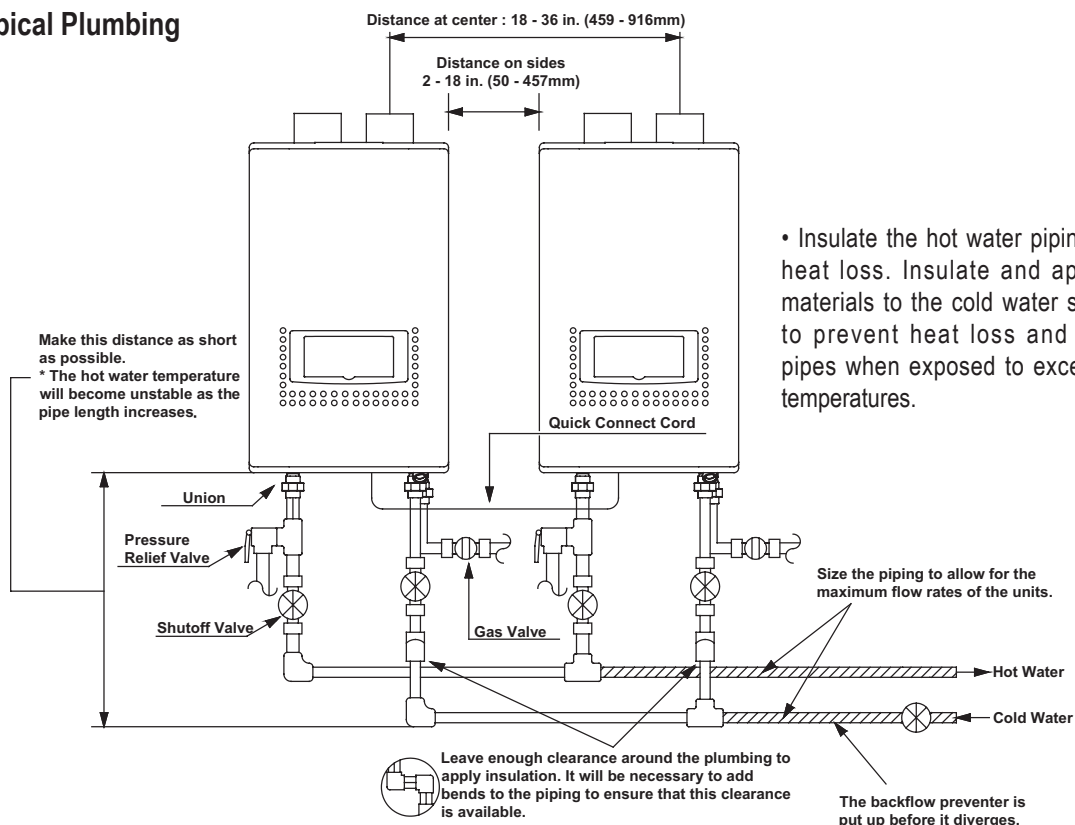

- Insulate the hot water piping to prevent heat loss. Insulate and apply heating materials to the cold water supply piping to prevent heat loss and freezing of pipes when exposed to excessively cold temperatures.

※ All units must be set to the same settings listed below before using in the Quick Connect Multi System.

1. Set “on” at [6:QC] in installer mode (Refer to below)
2. Current Clock Setting. (Refer to page 31 in the Installation Manual)
3. Recirculation Timer Setting, if recirculation is used. (Please refer to pages 22-27 in the Owner’s Guide)

<Note>

Auto (Self Learning Mode) Recirculation function is not available with the Quick Connect Systems.

■ **Connecting the Quick Connect Cable to the two units.**

1. Turn off the power.
2. Remove the front covers for both of the heaters (4 screws each)
3. Pass the Quick Connect Cord through the wiring throughway at the bottom of the units.
4. Plug the wire connector into the ‘Main PCB’ connector inside both units.
5. Replace the front covers.
6. Turn on the power.

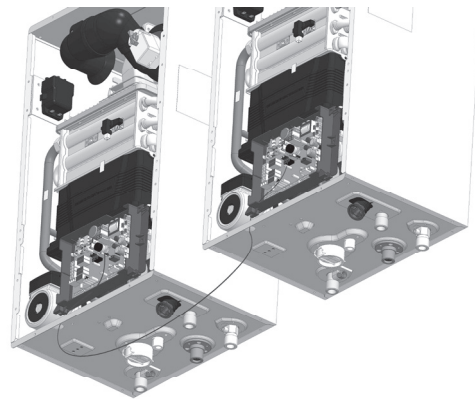
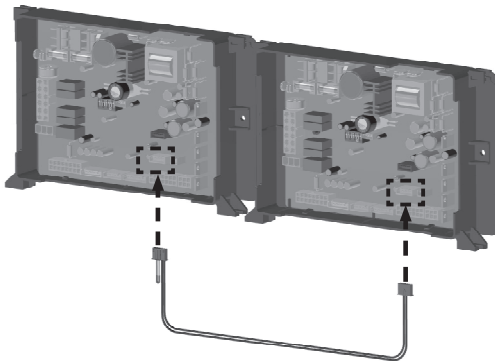

1. Turn off the power to the control panel. Press and hold the ‘Function Button’ for approximately 5 seconds to get into the ‘Installer mode’.

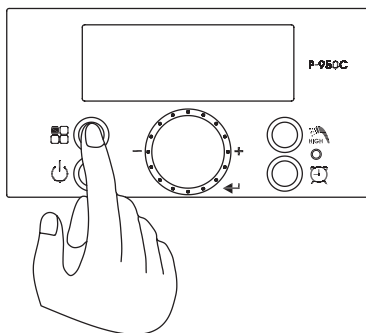

2. Turn the dial button to ‘[6:QC]’
3. Press the dial button, the “oFF” character will now be flashing.

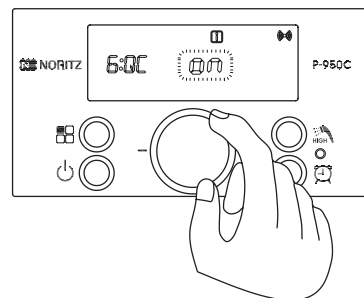

4. Turn the dial button clockwise to select ‘on’ in order to activate Quick Connect Multi System function.
5. Press the dial button to store the current setting and return back to ‘Installer mode’.
6. Repeat this procedure for the second unit.

Index	Parameter	Description
CA01	Quick connect mode : Master water heater	If ‘Quick connect mode’ is activated, [CA01]/[CA02] character appears on the display screen..
CA02	Quick connect mode : Slave water heater	

<Note>

CA:01(Master) unit will be able to set as first setting “on” at [6:QC] in installer mode.
 Other unit will be automatically set CA:02(Slave) as second setting “on” at [6:QC] in installer mode.

4-10. Common Vent

When Noritz water heaters are installed in a Noritz Quick Connect Multi System, you can install a common venting system. Do not use common venting if the water heater is used within a Noritz Quick Connect Multi System with other manufacturer’s water heaters or other models. Include a condensate drain in the main trunk as illustrated in the following examples.

1. Turn off the power to the control panel. Press and hold the ‘Function Button’ for approximately 5 seconds to get into the ‘Installer mode’.

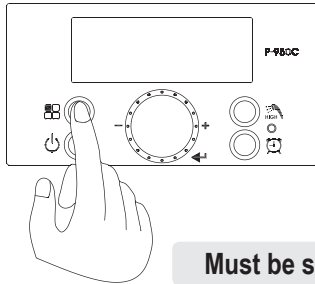

3. Press the dial button, the “on” or “oFF” character will be flashing.

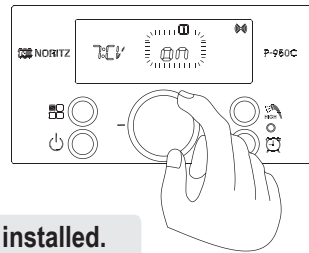

Must be set up each product installed.

2. Turn the dial button to ‘[7:CV]’.

<Note>

If [6:QC] is turned on, then [7:CV] will automatically be on when first set.

4. Turn the dial button counter-clockwise to select “oFF” if you want to install with a individual venting system for each unit, or turn the dial button clockwise to select “on” if you want to use the common venting feature.

5. Press the dial button to store the current setting and return back to ‘Installer mode’.

The following are examples of common venting options:

<Warning>

This Common Vent System must be installed by a licensed technician, failure to properly install this system may result in property damage, serious injury to occupants, or possibly death.

Venting Intake and Exhaust (Direct Vent)

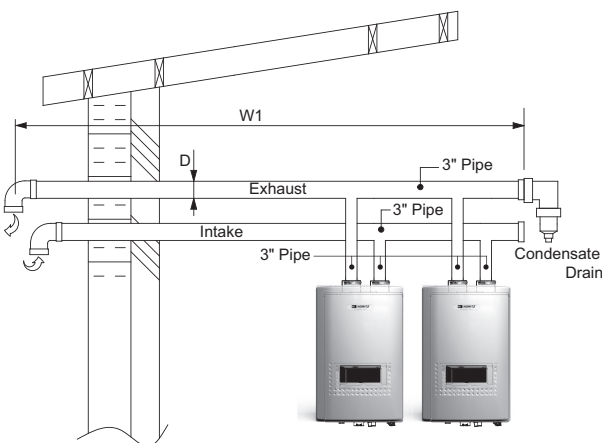

Venting Intake and Exhaust to the sidewall

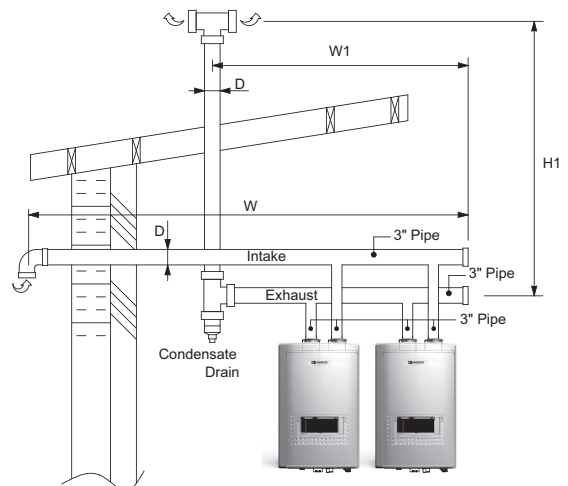

Venting Intake and Exhaust to the different location

<Note>

1. For clearance requirements between the exhaust and intake determinations refer to pg. 16-18 of the Installation Manual.
2. Insert bird screen on elbow terminals.
3. Make sure condensate drain hole size should be more than 1/2”.

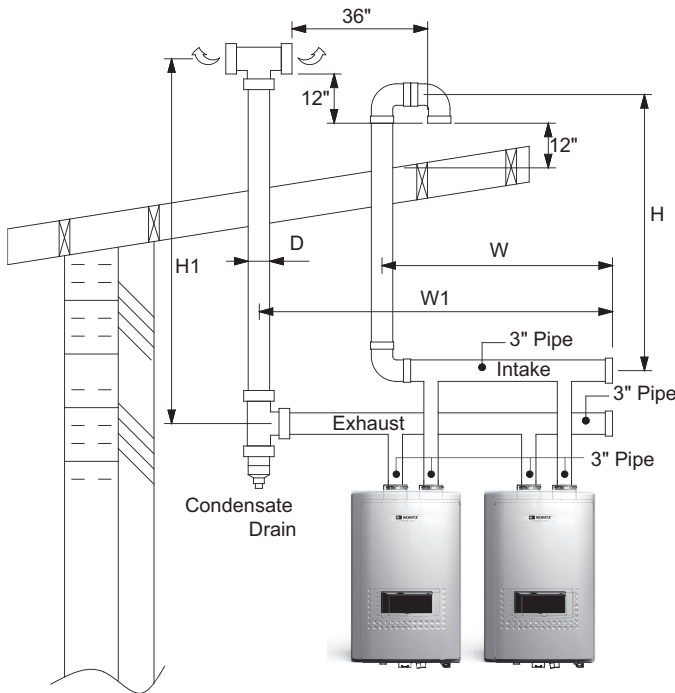

Venting Intake and Exhaust to the roof

● To determine the size of a common vent:

Determine the total length (L) of the common vent, which consist of the horizontal width (W/W1) and vertical height (H/H1)

Total Length (L) = W + H + W1 + H1

Require Load Total BTU/H	Total Length (ft)
398,000	100 (30m)

● Maximum Vent Length

No. of Elbows	Max. straight vent length
4	68'
3	76'
2	84'
1	92'
0	100'

<Note>

For each short radius elbow that will be used in the vent, add 8 feet (2.4 m) to the total length. For each long radius elbow that will be used in the vent, add 5 feet (1.5m) to the total length.

Venting the Exhaust only (Non-Direct)

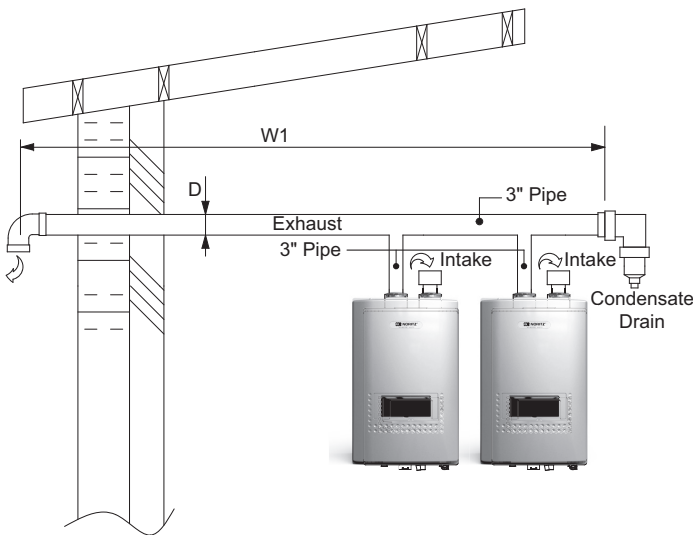

Venting the Exhaust only to the side wall

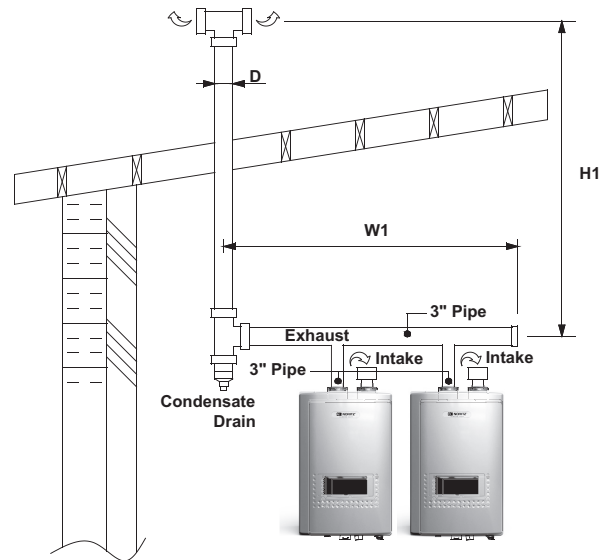

Venting the Exhaust only to the roof

5-1. Maintenance Periodically check the following to ensure proper operation of the water heater..

- The venting system must be examined periodically by a qualified service technician to check for any leaks or corrosion.
- The burner flame must be checked periodically for a proper blue color and consistency.
- If the flame does not appear normal, the burner may need to be cleaned.
- If the burner needs to be cleaned, it must be performed by a qualified service technician.
- Do not obstruct the flow of combustion and ventilation air.
- The pressure relief valve must be operated once a year to ensure that it is functioning properly and there is no obstruction. Turn the power off to the unit before opening the relief valve, and make sure that water draining out of the valve will not cause any damage.
- If the relief valve discharges periodically, it may be due to thermal expansion in a closed water system. Contact the water supplier or a local plumbing inspector on how to correct this situation. Do not plug the relief valve.
- See Operation Manual for further maintenance.

⚠ WARNING

There is a scald potential if the output temperature is set too high.

Should overheating occur, or the gas supply fail to shut off, turn off the manual gas control valve to the appliance.

Do not use this appliance if any part has been under water. Immediately call a qualified service technician to inspect the appliance and to replace any part of the control system and any gas control which has been under water.

Periodically check and clean the filter inside the cold water inlet of the unit.

MAINTENANCE REPORT

⚠ CAUTION

In unusually dirty or dusty conditions, care must be taken to keep water heater cabinet door in place at all times. Failure to do so VOIDS WARRANTY!

⚠ WARNING

Allowing the water heater to operate with a dirty combustion chamber will hurt operation. Failure to clean the heat exchanger as needed by the installation location could result in water heater failure, property damage, personal injury, or death. Such product failures ARE NOT covered under warranty.

The water heater requires minimal periodic maintenance under normal conditions. However, in unusually dirty or dusty conditions, periodic vacuuming of the cover to maintain visibility of the display and indicators is recommended. Periodic maintenance should be performed once a year by a qualified service technician to assure that all the equipment is operating safely and efficiently. The owner should make necessary arrangements with a qualified heating contractor for periodic maintenance of the water heater. Installer must also inform the owner that the lack of proper care and maintenance of the water heater may result in a hazardous condition.

INSPECTION ACTIVITIES		DATE LAST COMPLETED			
		1st YEAR	2nd YEAR	3rd YEAR	4th YEAR
Piping					
Near water heater piping	Check water heater and system piping for any sign of leakage. Leaking pipes could cause property damage. Make sure all piping is properly supported. Flush tankless heat exchanger annually (more in hard water conditions). See User's Information manual for instructions.				
Vent	Check condition of all vent pipes and joints. Ensure all vent piping is properly supported. Check for obstructions exhaust and intake termination points.				
Gas	Check Gas piping, test for leaks and signs of aging. Make sure all pipes are properly supported.				
SYSTEM					
Visual	Do a full visual inspection of all system components.				
Functional	Test all functions of the system (Heat, Safeties)				
ELECTRICAL					
Connections	Check wire connections. Make sure they are tight.				
Switch and Plug	Verify ON/OFF switch and convenience plug are both functional				
CONDENSATE					
Condensate Trap	Clean debris from the condensate trap. Fill with clean water.				
Neutralizer	Check condensate neutralizer. Replace if necessary.				
Condensate hose	Disconnect condensate hose. Clean out dirt and re-install. (NOTE: Verify the flow of condensate, making sure that the hose is properly connected during final inspection.)				
GAS					
Pressure	Measure incoming gas pressure (NG : 3.5" to 10.5" W.C.) (LP : 8.0" to 14" W.C.)				
Check gas pipe for leaks	Check piping for leaks. Verify that all are properly supported.				
COMBUSTION					
CO/CO2 Levels	Check CO and CO2 levels in Exhaust. Record at high and low fire.				

5-2. Final Check List

■ Final check : On the installation conditions.

- Is the Water Heater securely mounted on the wall?
- Is there space for a drain which is close to the Water Heater?
- Is there any combustible material near the Water Heater and vent pipe?
- Is the air supply sufficient for proper operation of the Water Heater?
- Are the proper service clearances maintained?
- Is the distance between the Water Heater and point of vent termination minimized?
- Are the proper space from windows, doors, and other intake vents maintained?

■ Final check : Gas pipe installation

- Is the gas supply line equipped with a manual shut off valve?
- Is the gas supply line a minimum of 3/4" inner diameter?
- Is the gas supply line length and diameter adequacy to deliver the required BTUs?
- Has the gas supply line pressure been measured?
- Does the gas type match with the type indicated on the rating plate?

■ Final check: Air / Vent pipe installation

- Has the Water Heater been vented with 2" or 3" PVC, CPVC, Polypropylene or BH Special Gas Vent (S636 PVC, CPVC) for Category IV appliances in accordance with this manual and/or your local code?
- Is the vent termination at least 12" above the exterior grade?
- Is the total vent length within the maximum vent length restriction?
- Have you checked the air/vent piping for leaks?
- Have you properly supported the vent termination?
- Are all vent runs properly supported?
- Is the vent sloped upward toward the vent termination at a rate of 1/4" per foot (2% grade)?

■ Final check : Condensate drain installation

- Have you installed a condensate drain line from the Water Heater to a drain or laundry tub?

■ Connecting the power supply

- Please check the power specifications. Is that AC 120V power?
- Have you checked the polarity of the electrical connection?

■ Final check : Pressure relief valve

- Have you installed an approved pressure relief valve on the water heater?
- Is the pressure relief valve of DHW Plumbing at least 3/4" in diameter?
- Have you installed the pressure relief valve on the hot water outlet pipe near the Water Heater?

■ Final check : Burner flames

- The burner flame must be checked periodically for a constant proper blue color.
- If the flame does not appear normal, the burner may need to be cleaned.
- If the burner needs to be cleaned, it must be performed by a qualified service technician.

Installation Manual

Register your Warranty online at www.noritz.com/warranty



NORITZ AMERICA CO. 11160 Grace Avenue Fountain Valley, CA 92708
Phone : 866 - 766 - 7489